

THIS DRAWING IS UNPUBLISHED.

RELEASED FOR PUBLICATION APR , 2005.

© COPYRIGHT 2005 Tyco Electronics JAPAN G.K.

ALL RIGHTS RESERVED.

REVISIONS

変更

P	LTR	DESCRIPTION	DATE	DWN	APVD
	E2	REVISED ECR-17-000147	11JAN2017	K.S	D.Z

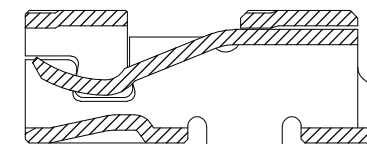
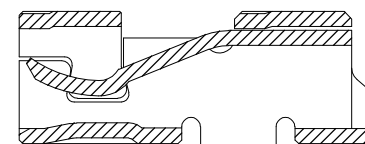
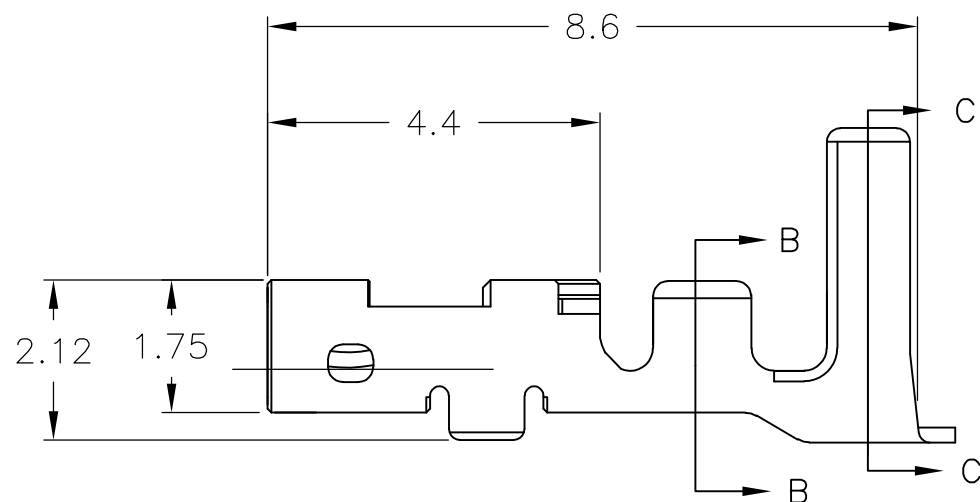
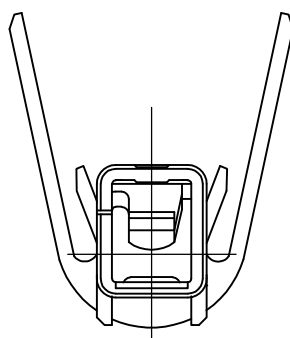
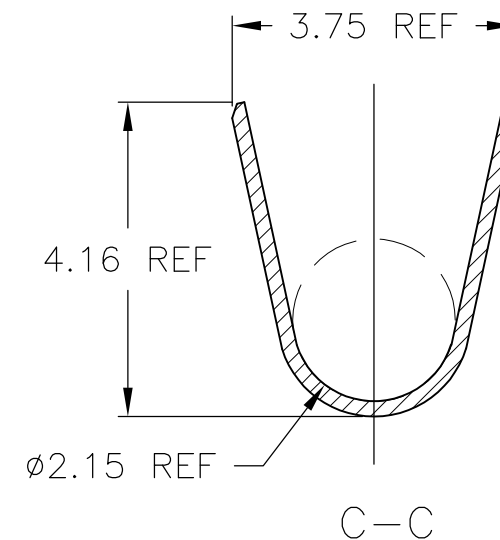
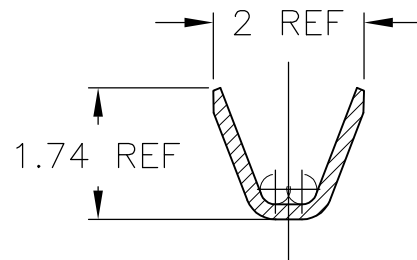
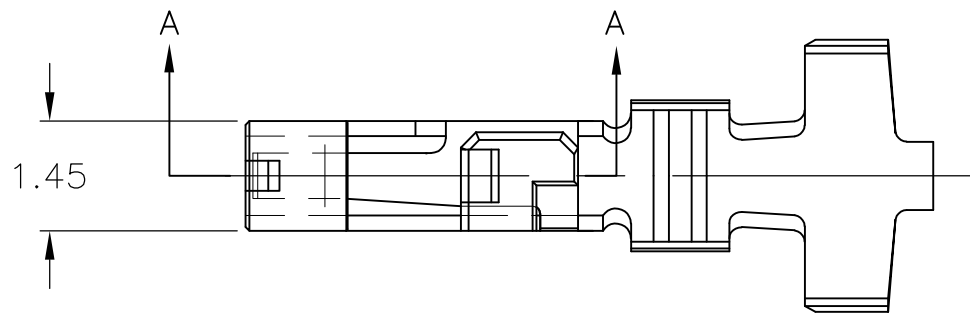
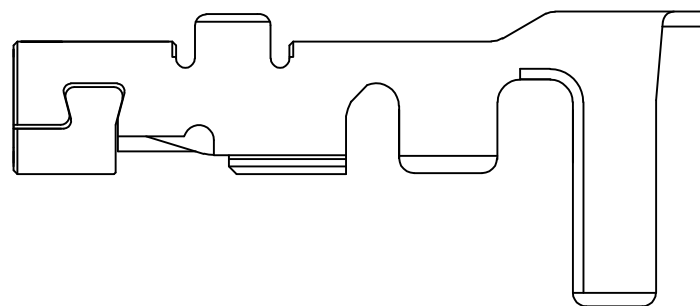

A-A (P/N1827395-1)

A-A (P/N1827395-2)

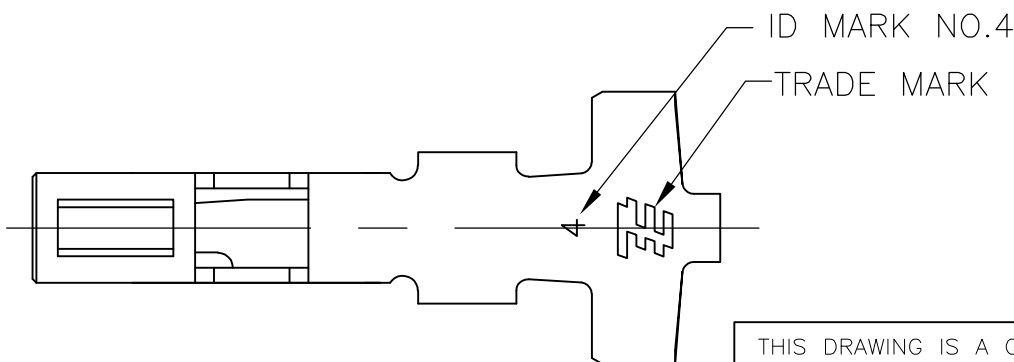

- 1 一般公差: ±0.25
- 2 材料: 錫めっき済 銅合金
- 3 適用電線: AWG #20-#24 (被覆外径φ1.5~φ2.5)

- 1 GENERAL TOLERANCE: ±0.25
- 2 MATERIAL: PRE-TIN COPPER ALLOY
- 3 APPLICABLE WIRE: AWG #20-#24 (INS DIAφ1.5~φ2.5)

1827395-2
1827395-1
PART NUMBER

THIS DRAWING IS A CONTROLLED DOCUMENT.		DWN T.HATANO 12APR2005	 TE Connectivity		
DIMENSIONS: 単位: 耗 mm		CHK A.OISHI 12APR2005			
TOLERANCES UNLESS OTHERWISE SPECIFIED: 一般公差		APVD N.YAMASAKI 12APR2005	NAME 名称 GRACE INERTIA CONNECTOR 3.3 REC CONTACT		
0 PLC ±		PRODUCT SPEC 製品規格 108-78231	RESTRICTED TO		
1 PLC ±		APPLICATION SPEC 取付適用規格 114-5372	SIZE A3	CAGE CODE 00779	DRAWING NO 番号 C-1827395
2 PLC ±		WEIGHT 0	SCALE 尺度 10:1		SHEET 1 OF 1
3 PLC ±		CUSTOMER DRAWING	REV E2		
4 PLC ±					
ANGLES ±					
FINISH 仕上					
MATERIAL 材料 SEE NOTE					

Mouser Electronics

Authorized Distributor

Click to View Pricing, Inventory, Delivery & Lifecycle Information:

[TE Connectivity:](#)

[1827395-1](#)