

PXD30-xxWDxx Dual Output DC/DC Converters

9 to 36 Vdc and 18 to 75 Vdc input, ± 5 to ± 15 Vdc Dual Output, 30W



Applications

- Wireless Network
- Telecom/Datacom
- Industry Control System
- Measurement
- Semiconductor Equipment

Features

- RoHS compliant
- Dual output up to ± 3000 mA
- Six-sided continuous shield
- No minimum load required
- High power density
- High efficiency up to 88%
- Small size
2.00 x 1.00 x 0.400 inch (50.8 x 25.4 x 10.2 mm)
- Input to output isolation (1600VDC)
- 4:1 ultra wide input voltage range
- Fixed switching frequency
- Input under-voltage protection
- Output over-voltage protection
- Over-current protection
- Output short circuit protection
- Remote on/off
- Case grounding

Options

- Negative logic Remote On/Off
- Heatsink

General Description

The PXD30-xxWDxx dual output series offers 30 watts of output power from a 2 x 1.0 x 0.4 inch package. This converter has a 4:1 ultra wide input voltage of 9-36VDC, 18-75VDC and features 1600VDC of isolation, short circuit protection, over-voltage protection, over-current protection and six sided shielding. All models are particularly suited for telecommunications, industrial, mobile telecom and test equipment applications.

Table of Contents

Absolute Maximum Rating	P2	Thermal Consideration	P20
Output Specification	P2	Heatsink Consideration	P20
Input Specification	P3	Remote ON/OFF Control	P21
General Specification	P4	Mechanical Data	P22
Characteristic Curves	P5	Recommended Pad Layout	P22
Testing Configurations	P17	Soldering Consideration	P23
EMC Considerations	P18	Packaging Information	P24
Input Source Impedance	P19	Part Number Structure	P25
Output Over Current Protection	P19	Safety and Installation Instruction	P25
Output Over Voltage Protection	P19	MTBF and Reliability	P25
Short Circuit Protection	P19		

Absolute Maximum Ratings				
Parameter	Model	Min	Max	Unit
Input Voltage				
Continuous	24WDxx 48WDxx		40 80	Vdc
Transient (100ms)	24WDxx 48WDxx		50 100	
Operating Ambient Temperature				
without derating	All	-40	50	□
with derating		50	85	
Operating Case Temperature			105	□
Storage Temperature	All	-55	125	□

Output Specification					
Parameter	Model	Min	Typ	Max	Unit
Output Voltage					
(Vin = Vin(nom) ; Full Load ; TA=25°C)	xxWD05 xxWD12 xxWD15	4.95 11.88 14.85	5 12 15	5.05 12.12 15.15	Vdc
Output Regulation					
Line (Vin(min) to Vin(max) at Full Load)	All	-0.2		+0.2	% Vo
Load (0% to 100% of Full Load) DIP type		-1.0		+1.0	
Cross Regulation					
Asymmetrical Load 25% / 100% of Full Load	All	-5.0		+5.0	% Vo
Output Ripple & Noise					
Peak-to-Peak (5Hz to 20MHz bandwidth)	xxWD05 xxWD12 xxWD15			100 150 150	mVp-p
(Measured with a 1μF/50V MLCC)					
Temperature Coefficient	All	-0.02		+0.02	% Vo
Output Voltage Overshoot					
(Vin(min) to Vin(max) ; Full Load ; TA=25°C □)	All		0	5	% Vo
Dynamic Load Response					
(Vin = Vin(nom) ; TA=25°C)					
Load step change from					
75% to 100% or 100 to 75% of Full Load	All		300		mV
Peak Deviation	All		250		μs
Setting Time (Vo < 10% peak deviation)					
Output Current					
	xxWD05 xxWD12 xxWD15	0 0 0		±3000 ±1250 ±1000	mA
Output Over Voltage Protection					
(Zener diode clamp)	xxWD05 xxWD12 xxWD15		6.2 15 18		Vdc
Output Over Current Protection	All		150		% FL.
Output Short Circuit Protection	Hiccup, automatic recovery				

Input Specification										
Parameter	Model	Min	Typ	Max	Unit					
Operating Input Voltage	24WDxx	9	24	36	Vdc					
	48WDxx	18	48	75						
Input Current (Maximum value at $V_{in} = V_{in(nom)}$; Full Load)	24WD05			1488	mA					
	24WD12			1506						
	24WD15			1506						
	48WD05			744						
	48WD12			744						
	48WD15			744						
Input Standby Current (Typical value at $V_{in} = V_{in(nom)}$; No Load)	24WD05		90		mA					
	24WD12		25							
	24WD15		25							
	48WD05		50							
	48WD12		15							
	48WD15		15							
Under Voltage Lockout Turn-on Threshold	24WDxx		9		Vdc					
	48WDxx		18							
Under Voltage Lockout Turn-off Threshold	24WDxx		8		Vdc					
	48WDxx		16							
Input reflected ripple current (5 to 20MHz, 12 μ H source impedance)	All		20		mAp-p					
Start Up Time ($V_{in} = V_{in(nom)}$ and constant resistive load)	All									
						Power up	30	ms		
						Remote ON/OFF	30	ms		
Remote ON/OFF Control (The On/Off pin voltage is referenced to - V_{in}) Positive logic (Standard)	All									
						On/Off pin High Voltage (Module ON)	3.0	12	Vdc	
						On/Off pin Low Voltage (Module OFF)	0	1.2	Vdc	
						Negative logic (Option)				
						On/Off pin High Voltage (Module OFF)	3.0	12	Vdc	
						On/Off pin Low Voltage (Module ON)	0	1.2	Vdc	
Remote Off Input Current	All		3		mA					
Input Current of Remote Control Pin	All	-0.5		0.5	mA					

General Specification					
Parameter	Model	Min	Typ	Max	Unit
Efficiency ($V_{in} = V_{in(nom)}$); Full Load ; $T_A=25^{\circ}C$)	24WD05		88.0		%
	24WD12		87.0		
	24WD15		87.0		
	48WD05		88.0		
	48WD12		88.0		
	48WD15		88.0		
Case grounding	All	Connect case to $-V_{in}$ with decoupling Y cap.			
Isolation voltage Input to Output Input to Case, Output to Case	All	1600 1600			Vdc
Isolation resistance	All	1			G Ω
Isolation capacitance	All			1500	pF
Switching Frequency	All		430		kHz
Weight	All		30.5		g
MTBF Bellcore TR-NWT-000332, $T_C=40^{\circ}C$ □ MIL-HDBK-217F	All		3.163 $\times 10^6$ 4.347 $\times 10^5$		hours
Over Temperature Protection	All		115		$^{\circ}C$

Characteristic Curves

All test conditions are at 25°C. The figures are for PXD30-24WD05

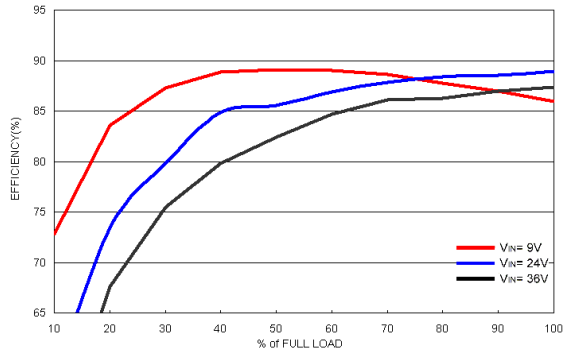

Efficiency Versus Output Current

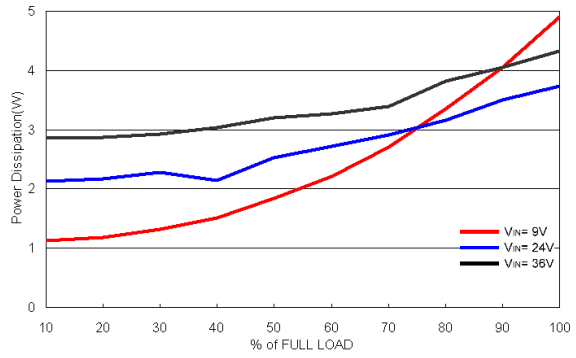

Power Dissipation Versus Output Current

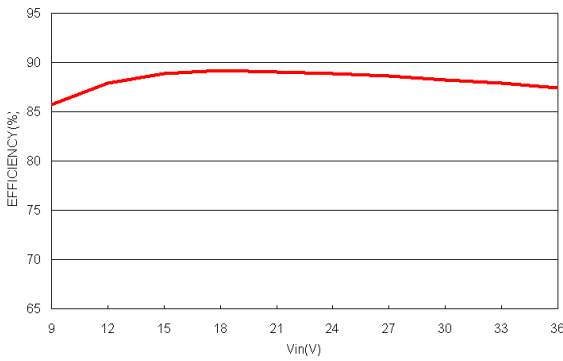

Efficiency Versus Input Voltage. Full Load

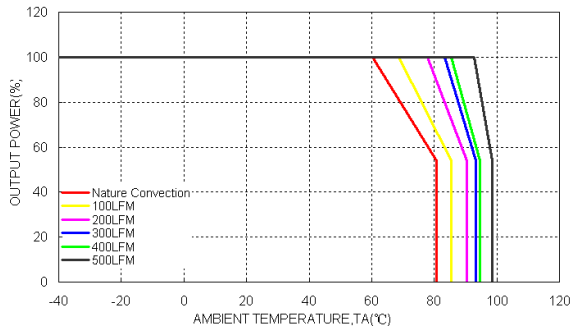

Derating Output Current Versus Ambient Temperature and Airflow
 $V_{in}=V_{in}(nom)$



Characteristic Curves (Continued)

All test conditions are at 25°C . The figures are for PXD30-24WD05

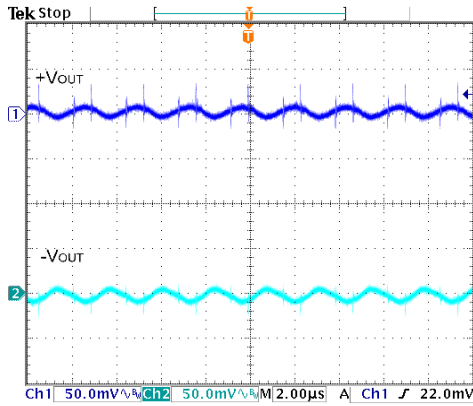

Typical Output Ripple and Noise.
Vin=Vin(nom), Full Load

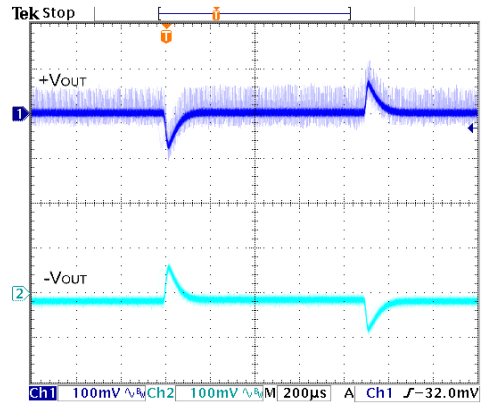

Transient Response to Dynamic Load Change from
100% to 75% to 100% of Full Load ; Vin=Vin(nom)

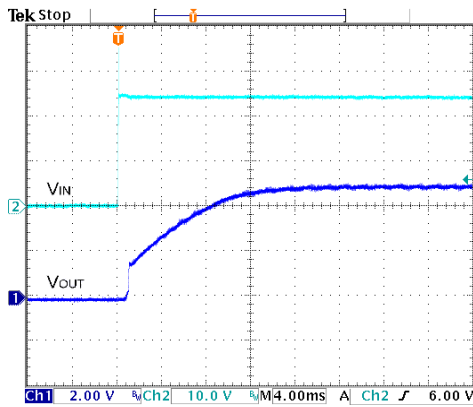

Typical Input Start-Up and Output Rise Characteristic
Vin=Vin(nom), Full Load

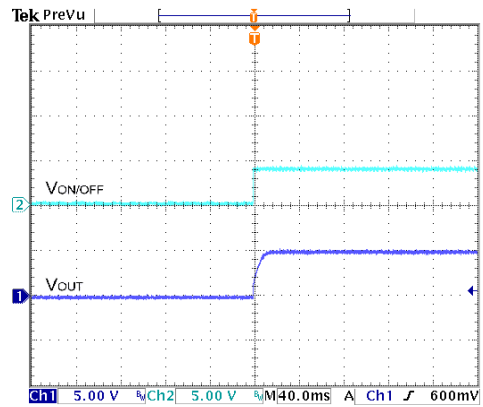

Using ON/OFF Voltage Start-Up and Vo Rise Characteristic
Vin=Vin(nom), Full Load

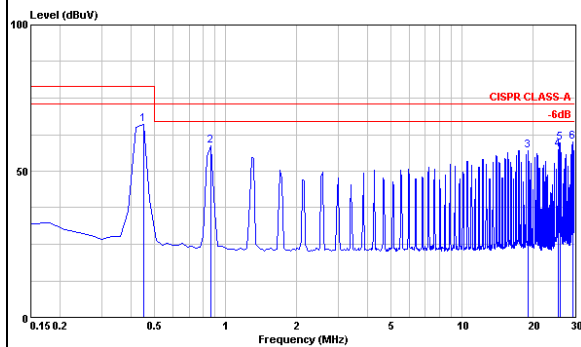

Conduction Emission of EN55022 Class A
Vin=Vin(nom), Full Load

Characteristic Curves (Continued)

All test conditions are at 25°C . The figures are for PXD30-24WD12

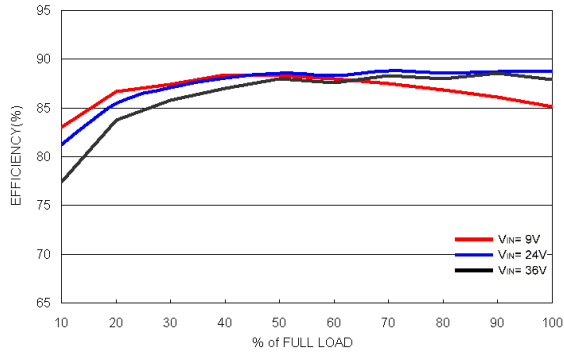

Efficiency Versus Output Current

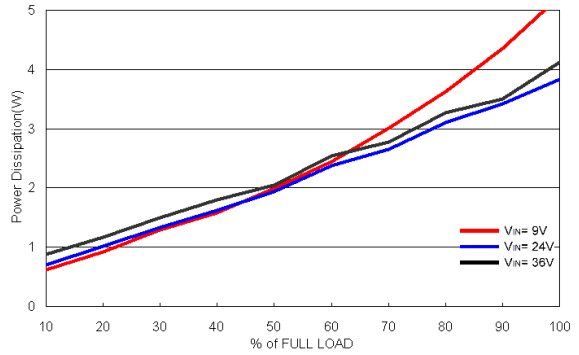

Power Dissipation Versus Output Current

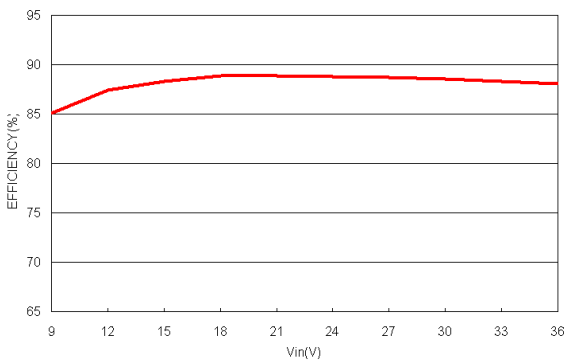

Efficiency Versus Input Voltage. Full Load

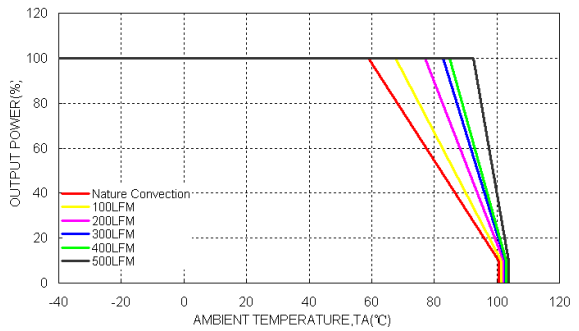

Derating Output Current Versus Ambient Temperature and Airflow
 $V_{in}=V_{in}(nom)$

Characteristic Curves (Continued)

All test conditions are at 25°C . The figures are for PXD30-24WD12

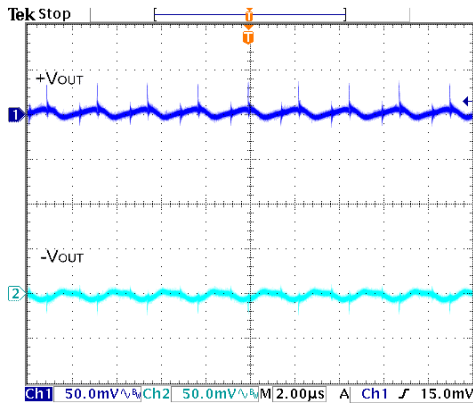

Typical Output Ripple and Noise.
Vin=Vin(nom), Full Load

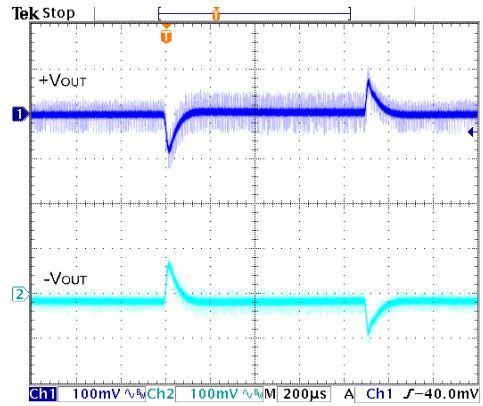

Transient Response to Dynamic Load Change from
100% to 75% to 100% of Full Load ; Vin=Vin(nom)

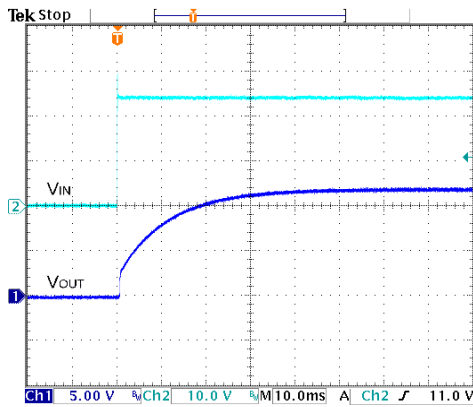

Typical Input Start-Up and Output Rise Characteristic
Vin=Vin(nom), Full Load

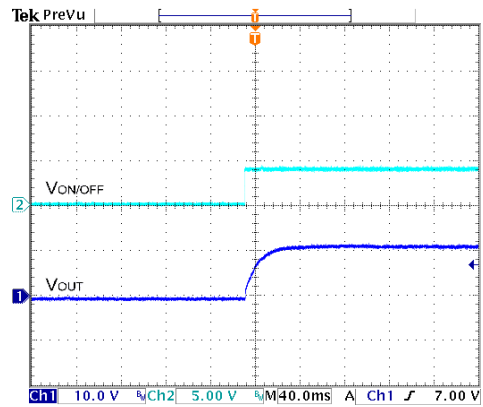

Using ON/OFF Voltage Start-Up and Vo Rise Characteristic
Vin=Vin(nom), Full Load

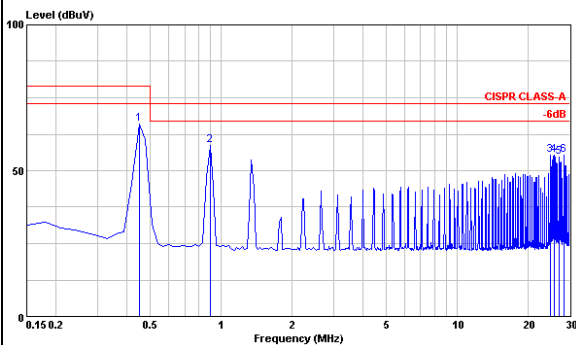

Conduction Emission of EN55022 Class A
Vin=Vin(nom), Full Load

Characteristic Curves (Continued)

All test conditions are at 25°C . The figures are for PXD30-24WD15

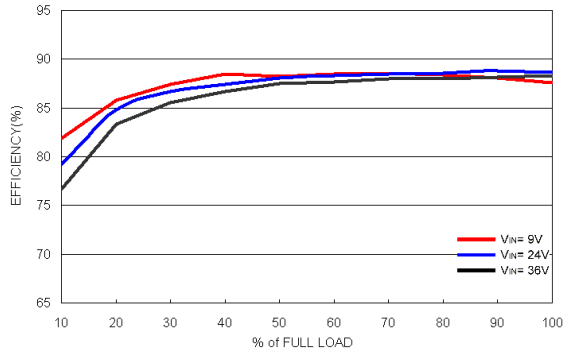

Efficiency Versus Output Current

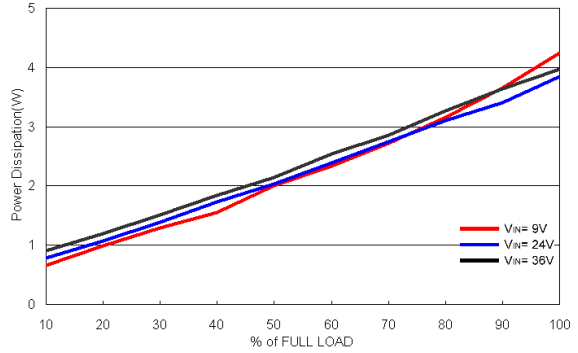

Power Dissipation Versus Output Current

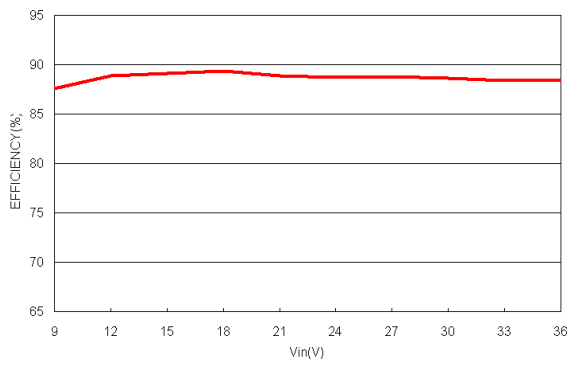

Efficiency Versus Input Voltage. Full Load

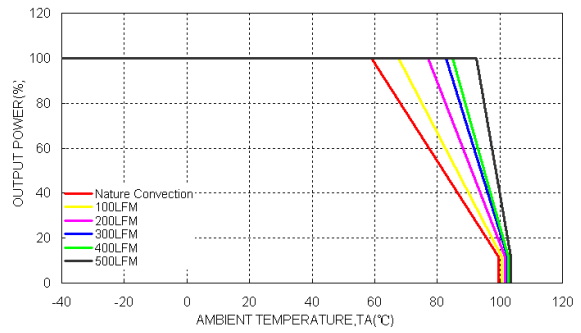

Derating Output Current Versus Ambient Temperature and Airflow
 $V_{in}=V_{in}(nom)$

Characteristic Curves (Continued)

All test conditions are at 25°C . The figures are for PXD30-24WD15

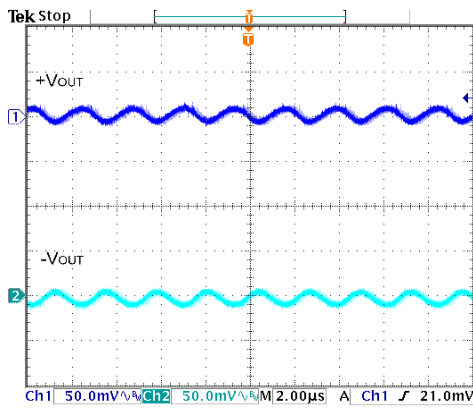

Typical Output Ripple and Noise.
Vin=Vin(nom), Full Load

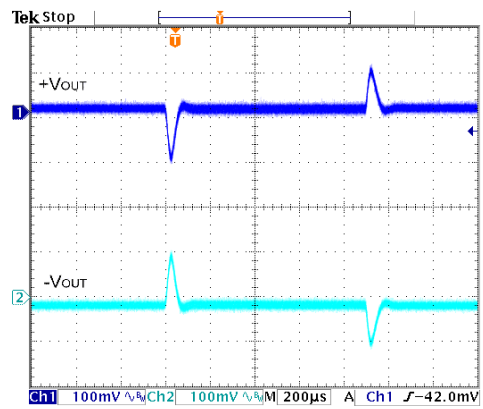

Transient Response to Dynamic Load Change from
100% to 75% to 100% of Full Load ; Vin=Vin(nom)

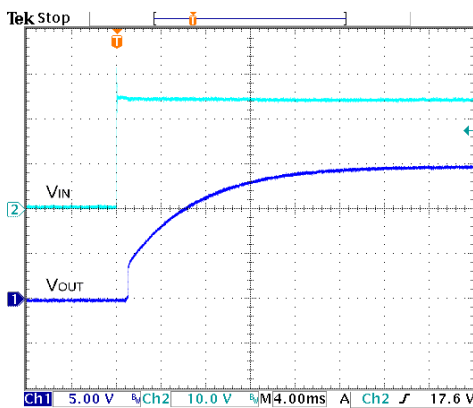

Typical Input Start-Up and Output Rise Characteristic
Vin=Vin(nom), Full Load

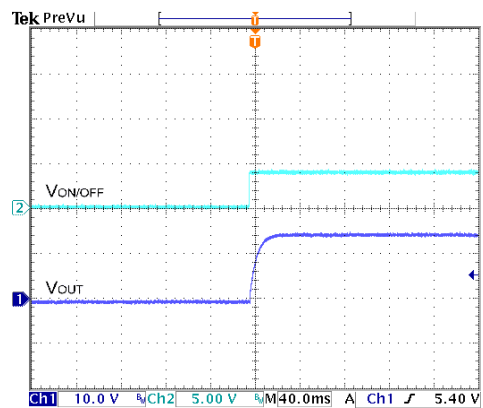

Using ON/OFF Voltage Start-Up and Vo Rise Characteristic
Vin=Vin(nom), Full Load

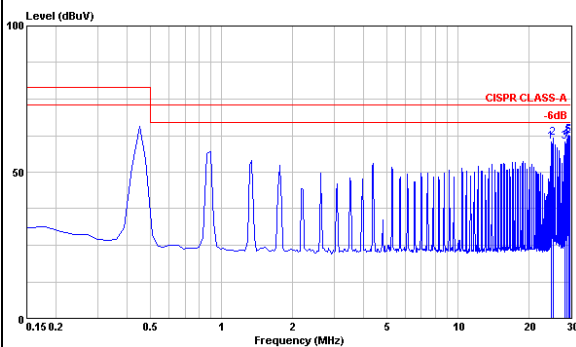

Conduction Emission of EN55022 Class A
Vin=Vin(nom), Full Load

Characteristic Curves (Continued)

All test conditions are at 25°C. The figures are for PXD30-48WD05.

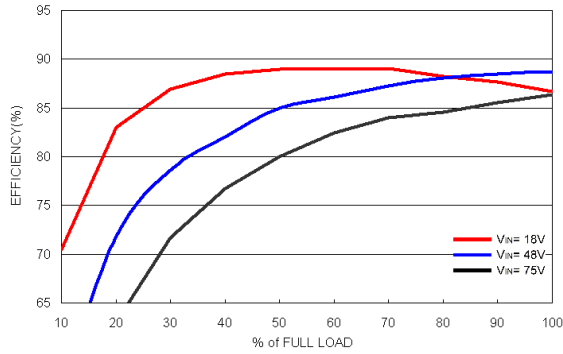

Efficiency Versus Output Current

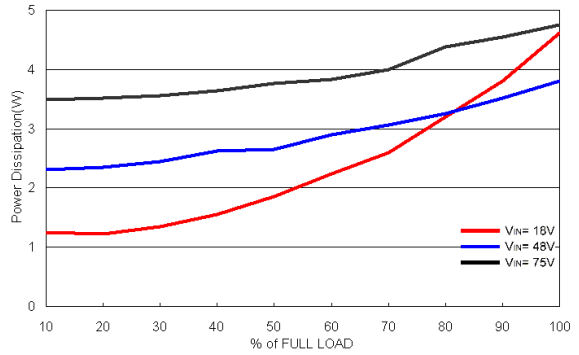

Power Dissipation Versus Output Current

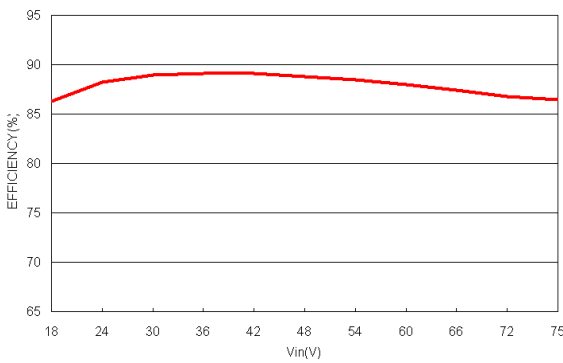

Efficiency Versus Input Voltage. Full Load

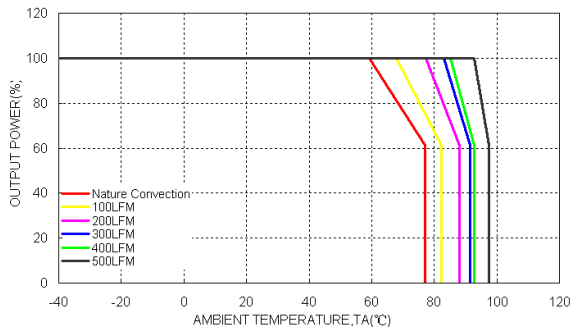

Derating Output Current Versus Ambient Temperature and Airflow
Vin=Vin(nom)

Characteristic Curves (Continued)

All test conditions are at 25°C . The figures are for PXD30-48WD05.

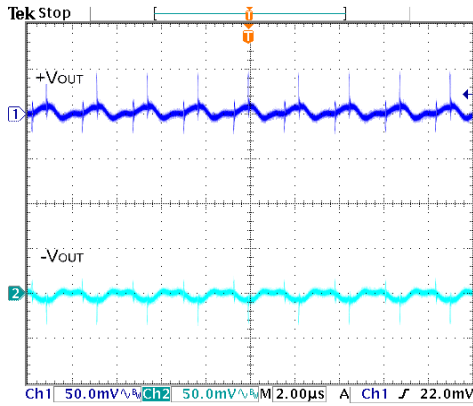

Typical Output Ripple and Noise.
Vin=Vin(nom), Full Load

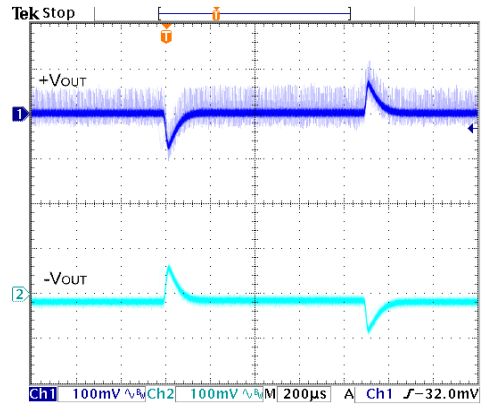

Transient Response to Dynamic Load Change from
100% to 75% to 100% of Full Load ; Vin=Vin(nom)

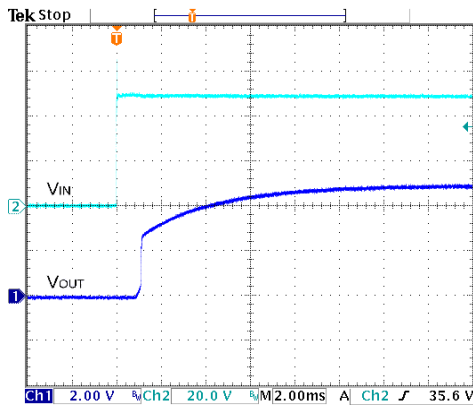

Typical Input Start-Up and Output Rise Characteristic
Vin=Vin(nom), Full Load

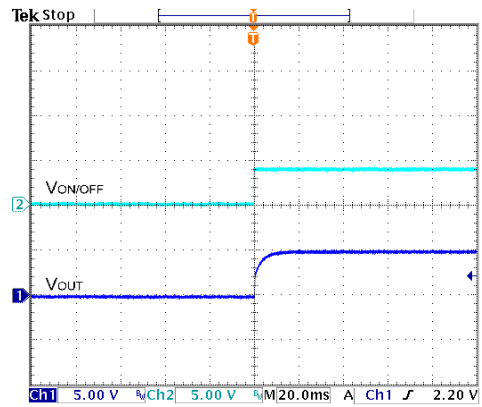

Using ON/OFF Voltage Start-Up and Vo Rise Characteristic
Vin=Vin(nom), Full Load

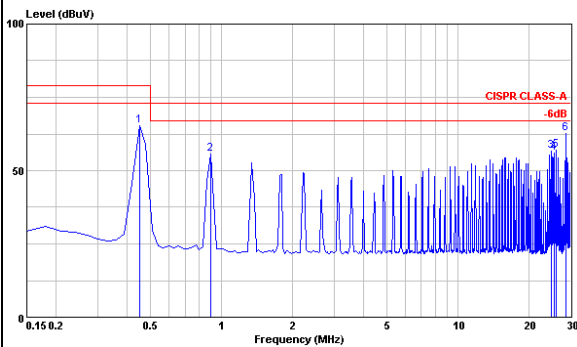

Conduction Emission of EN55022 Class A
Vin=Vin(nom), Full Load

Characteristic Curves (Continued)

All test conditions are at 25°C . The figures are for PXD30-48WD12.

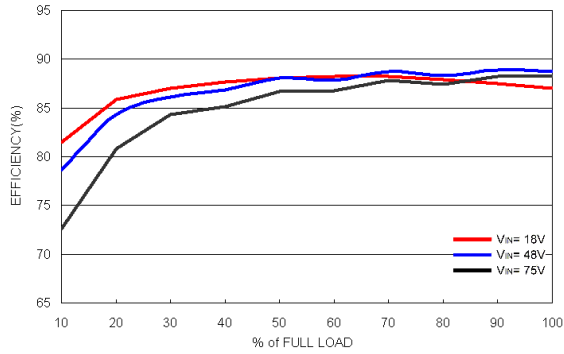

Efficiency Versus Output Current

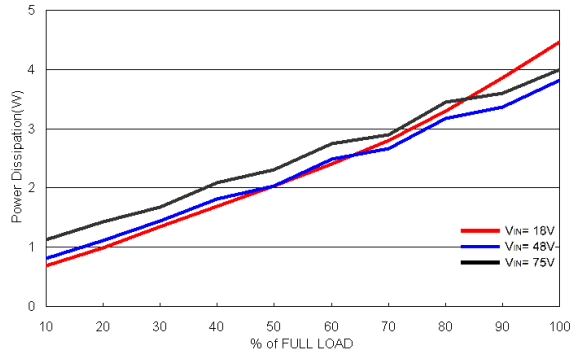

Power Dissipation Versus Output Current

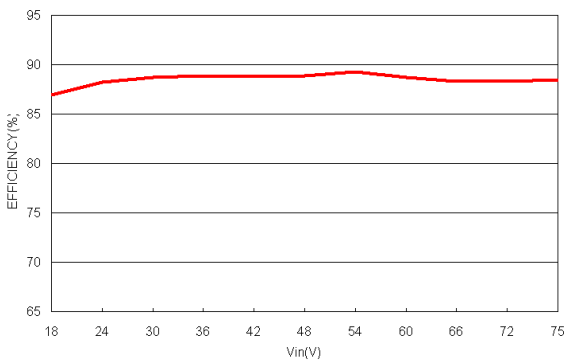

Efficiency Versus Input Voltage. Full Load

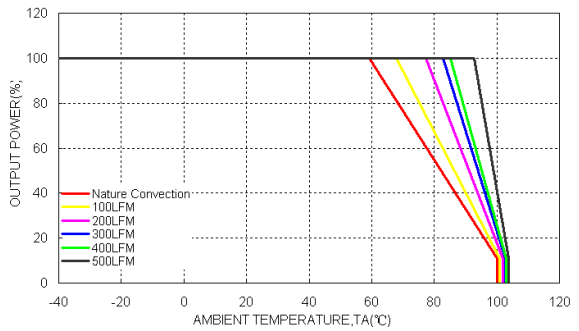

Derating Output Current Versus Ambient Temperature and Airflow
 $V_{in}=V_{in}(nom)$

Characteristic Curves (Continued)

All test conditions are at 25°C . The figures are for PXD30-48WD12.

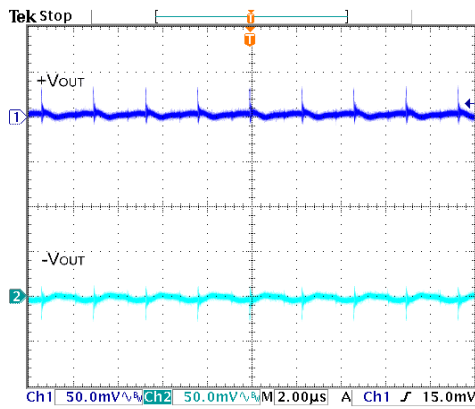

Typical Output Ripple and Noise.
Vin=Vin(nom), Full Load

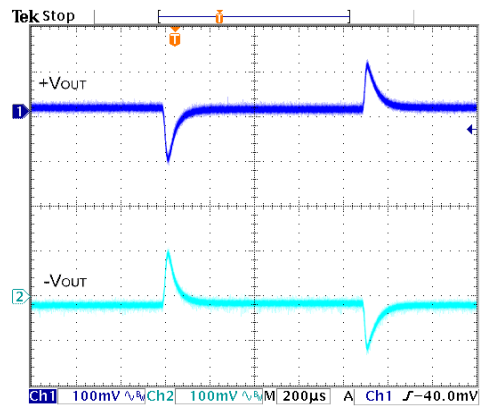

Transient Response to Dynamic Load Change from
100% to 75% to 100% of Full Load ; Vin=Vin(nom)

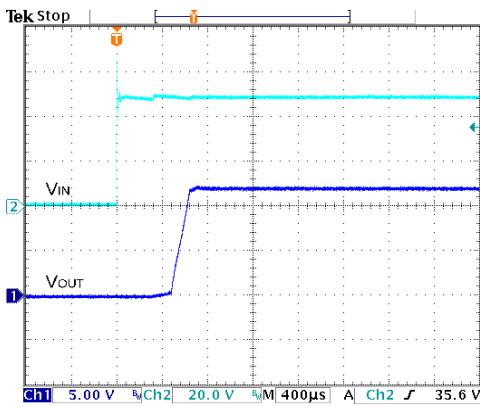

Typical Input Start-Up and Output Rise Characteristic
Vin=Vin(nom), Full Load

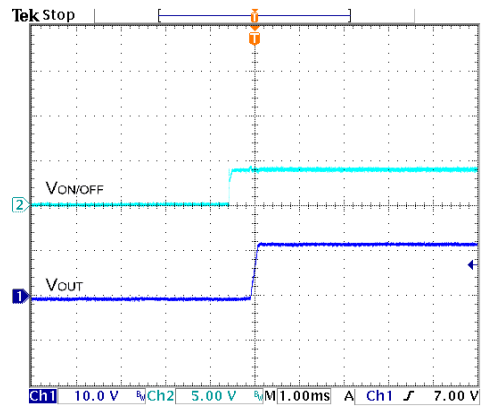

Using ON/OFF Voltage Start-Up and Vo Rise Characteristic
Vin=Vin(nom), Full Load

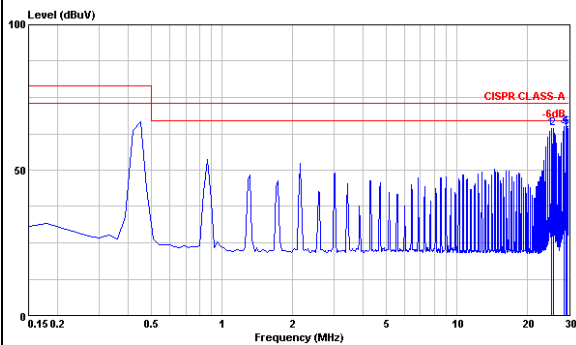

Conduction Emission of EN55022 Class A
Vin=Vin(nom), Full Load

Characteristic Curves (Continued)

All test conditions are at 25°C . The figures are for PXD30-48WD15.

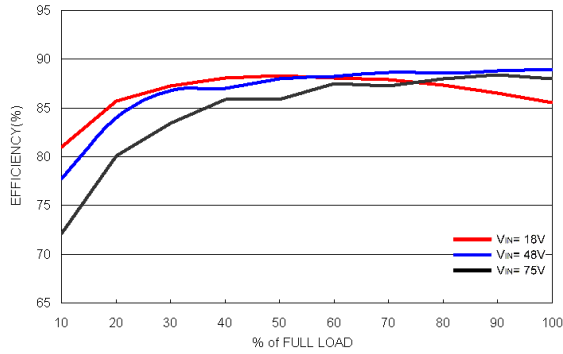

Efficiency Versus Output Current

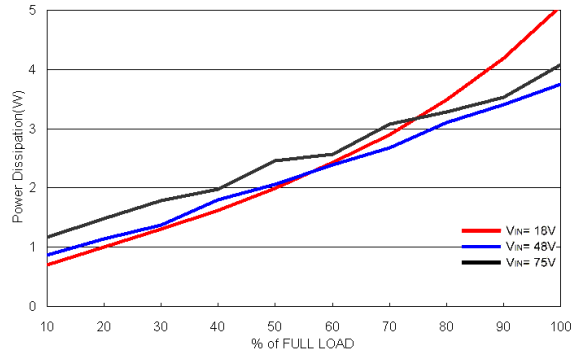

Power Dissipation Versus Output Current

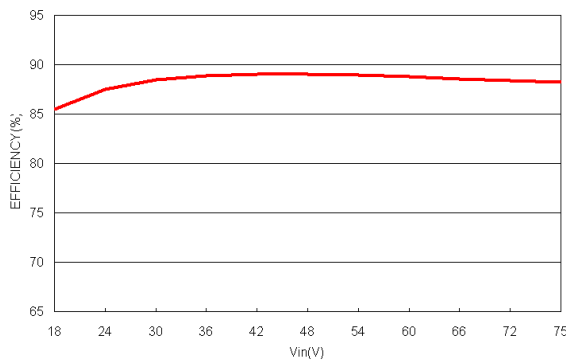

Efficiency Versus Input Voltage. Full Load

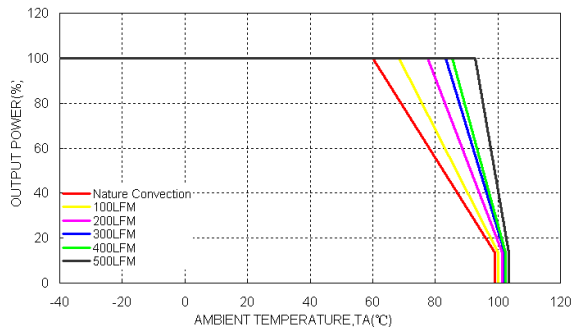

Derating Output Current Versus Ambient Temperature and Airflow
 $V_{in}=V_{in}(nom)$

Characteristic Curves (Continued)

All test conditions are at 25°C . The figures are for PXD30-48WD15.

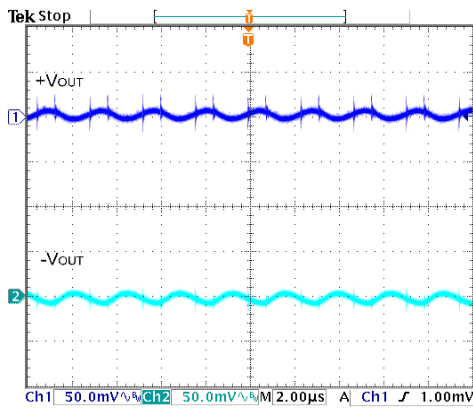

Typical Output Ripple and Noise.
Vin=Vin(nom), Full Load

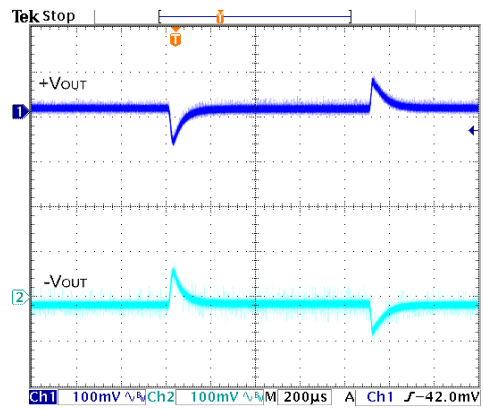

Transient Response to Dynamic Load Change from
100% to 75% to 100% of Full Load ; Vin=Vin(nom)

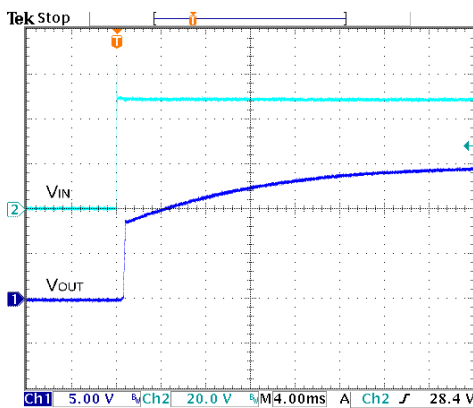

Typical Input Start-Up and Output Rise Characteristic
Vin=Vin(nom), Full Load

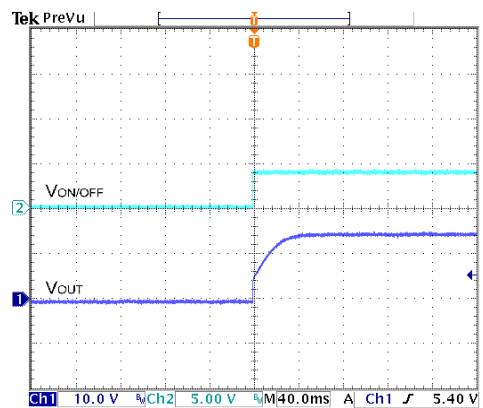

Using ON/OFF Voltage Start-Up and Vo Rise Characteristic
Vin=Vin(nom), Full Load

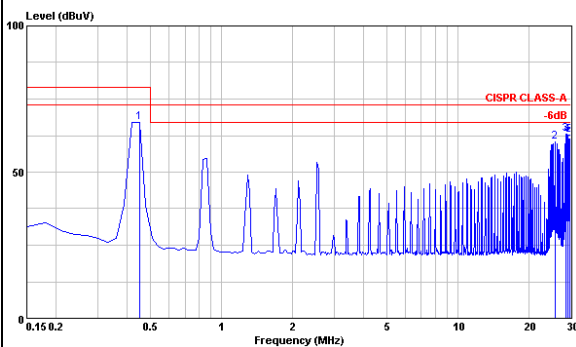

Conduction Emission of EN55022 Class A
Vin=Vin(nom), Full Load

Testing Configurations

Input reflected-ripple current measurement test:

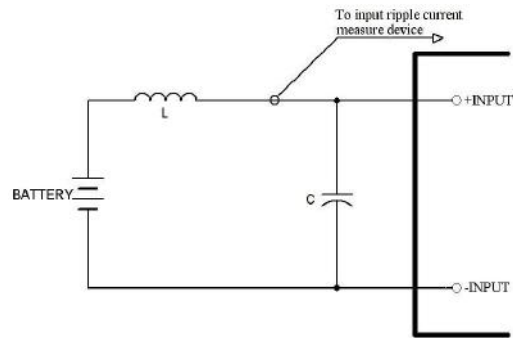

Component	Value	Voltage	Reference
L	12μH	---	---
C	47μF	100V	Aluminum Electrolytic Capacitor

Peak-to-peak output ripple & noise measurement test:

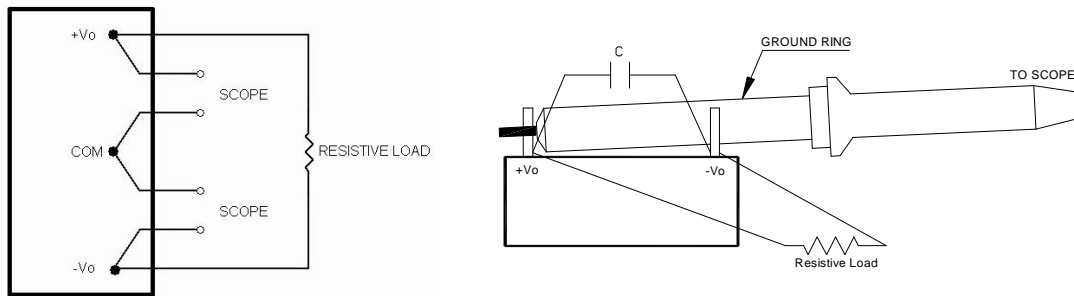

Output voltage and efficiency measurement test:

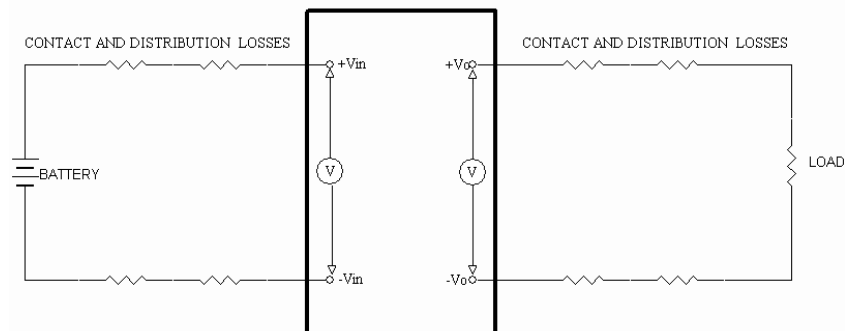

Note: All measurements are taken at the module terminals.

$$Efficiency = \left(\frac{V_o \times I_o}{V_{in} \times I_{in}} \right) \times 100\%$$

EMC Considerations

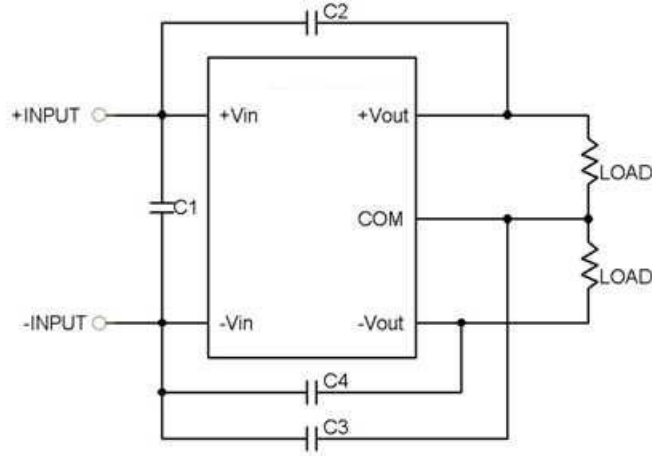

Suggested Schematic for EN55022 Conducted Emission Class A Limits

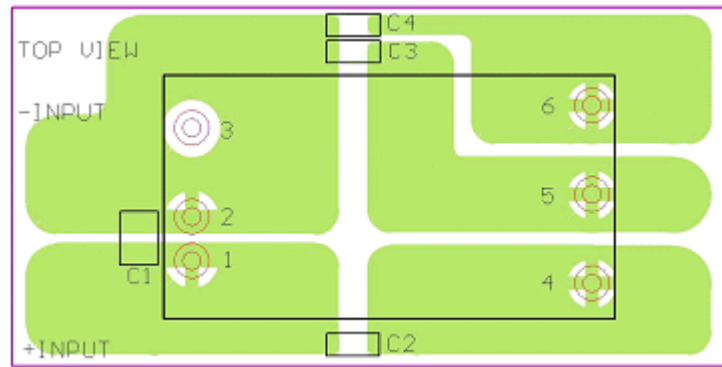

Recommended Layout With Input Filter

To meet conducted emissions EN55022 CLASS A the following components are needed:

PXD30-24WDxx

Component	Value	Voltage	Reference
C1	4.7uF	50V	1812 MLCC
C2、C3、C4	1000pF	2KV	1808 MLCC

PXD30-48WDxx

Component	Value	Voltage	Reference
C1	2.2uF	100V	1812 MLCC
C2、C3、C4	1000pF	2KV	1808 MLCC

Input Source Impedance

The converter should be connected to a low impedance input source. Highly inductive source impedance can affect the stability of the converter. Input external L-C filter is recommended to minimize input reflected ripple current. The inductor has a simulated source impedance of 12 μ H and capacitor is Nippon chemi-con KY series 47 μ F/100V. The capacitor must be located as close as possible to the input terminals of the converter for lower impedance.

Output Over Current Protection

When excessive output currents occur in the system, circuit protection is required on all converters. Normally, overload current is maintained at approximately 150 percent of rated current for PxD30-xxWDxx series.

Hiccup-mode is a method of operation in the converter whose purpose is to protect the converter from being damaged during an over-current fault condition. It also enables the converter to restart when the fault is removed.

One of the problems resulting from over current is that excessive heat may be generated in power devices; especially MOSFET and Schottky diodes and the temperature of those devices may exceed their specified limits. A protection mechanism has to be used to prevent those power devices from being damaged.

Output Over Voltage Protection

The output over-voltage protection consists of an output Zener diode that monitors the voltage on the output terminals. If the voltage on the output terminals exceeds the over-voltage protection threshold, then the Zener diode clamps the output voltage.

Short Circuit Protection

Continuous, hiccup and auto-recovery.

Thermal Consideration

The converter operates in a variety of thermal environments. Sufficient cooling should be provided to help ensure reliable operation of the unit. Heat is removed by conduction, convection, and radiation to the surrounding environment. Proper cooling can be verified by measuring the point as shown in the figure below. The temperature at this location should not exceed 105°C. When operating, adequate cooling must be provided to maintain the test point temperature at or below 105°C. Although the maximum point temperature of the converter is 105°C, limiting this temperature to a lower value will increase the reliability of this device.

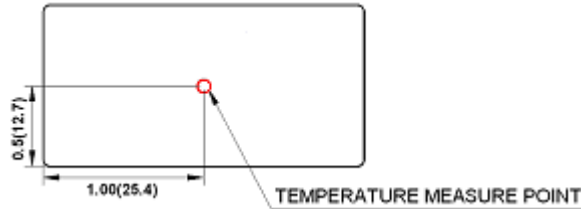

Measurement shown in inches and (millimeters)

TOP VIEW

Heat Sink Consideration

Use heat-sink (7G-0020C) for lowering temperature; thus increasing the reliability of the converter.

Heatsink + Clamp

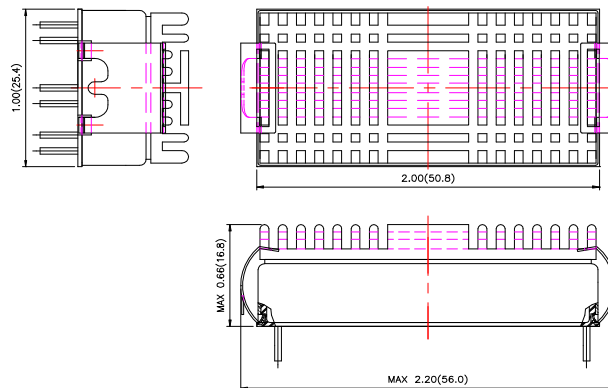

Heatsink

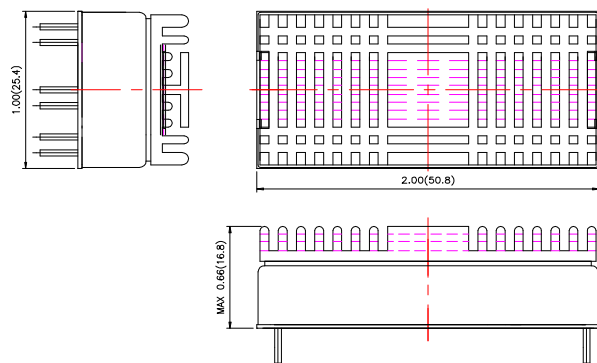

Measurement shown in inches and (millimeters)

Remote ON/OFF Control

Positive Logic – (no suffix) , the positive logic remote ON/OFF control circuit is included. Ex.: PXD30-24WD05
 Turns the converter ON during logic High on the On/Off pin and turns the converter OFF during logic Low.
 The On/Off pin is an open collector/drain logic input signal (Von/off) that is referenced to GND.
 If not using the remote on/off feature, an open circuit between on/off pin and (-) input pin is needed to turn the module on.

Negative Logic – (suffix -N), the negative logic remote ON/OFF control circuit is included. Ex.: PXD30-24WD05-N
 Turns the converter ON during logic Low on the On/Off pin and turns the converter OFF during logic High.
 The On/Off pin is an open collector/drain logic input signal (Von/off) that is referenced to GND.
 If not using the remote on/off feature, a short circuit between on/off pin and (-) input pin is needed to turn the module on.

Remote ON/OFF Implementation

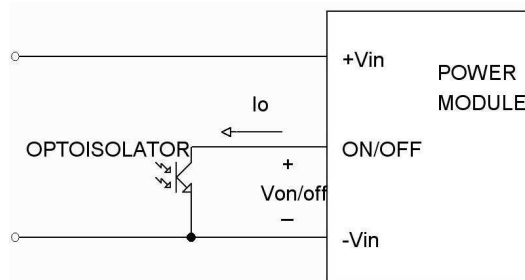

Isolated Control Remote ON/OFF

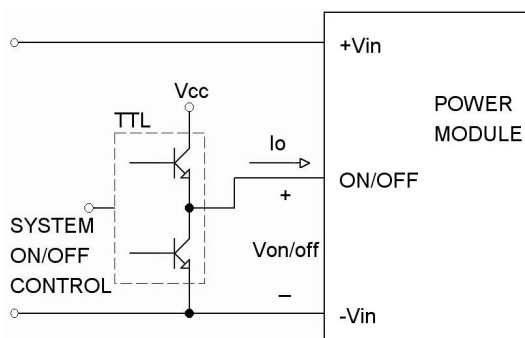

Level Control Using TTL Output

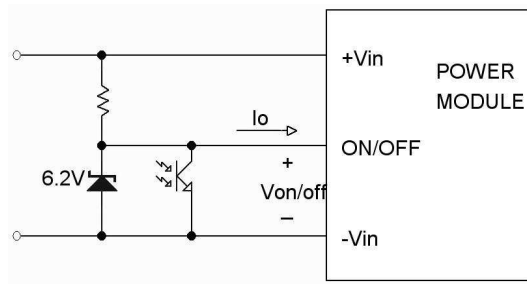

Level Control Using Line Voltage

Mechanical Data

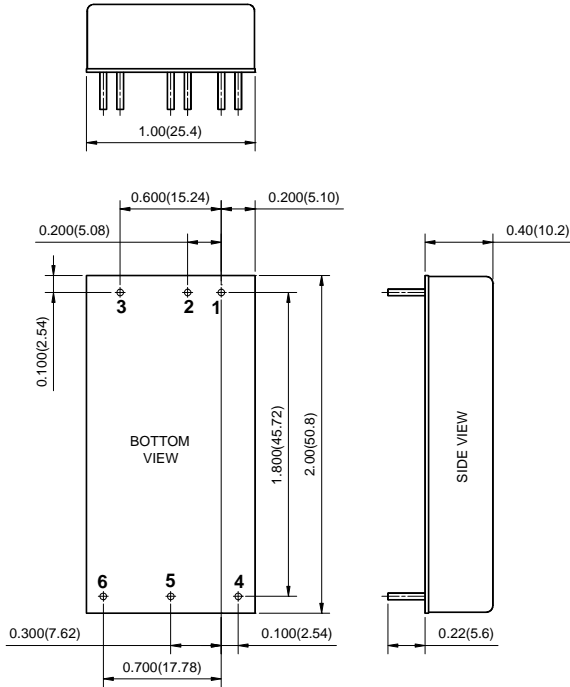

PIN CONNECTION	
PIN	FUNCTION
1	+ INPUT
2	- INPUT
3	CTRL
4	+OUTPUT
5	COM
6	- OUTPUT

1. All dimensions in Inches (mm)
Tolerance: X.XX±0.02 (X.X±0.5)
X.XXX±0.01 (X.XX±0.25)
2. Pin pitch tolerance ±0.01 (0.25)
3. Pin dimension tolerance ±0.004 (0.1)

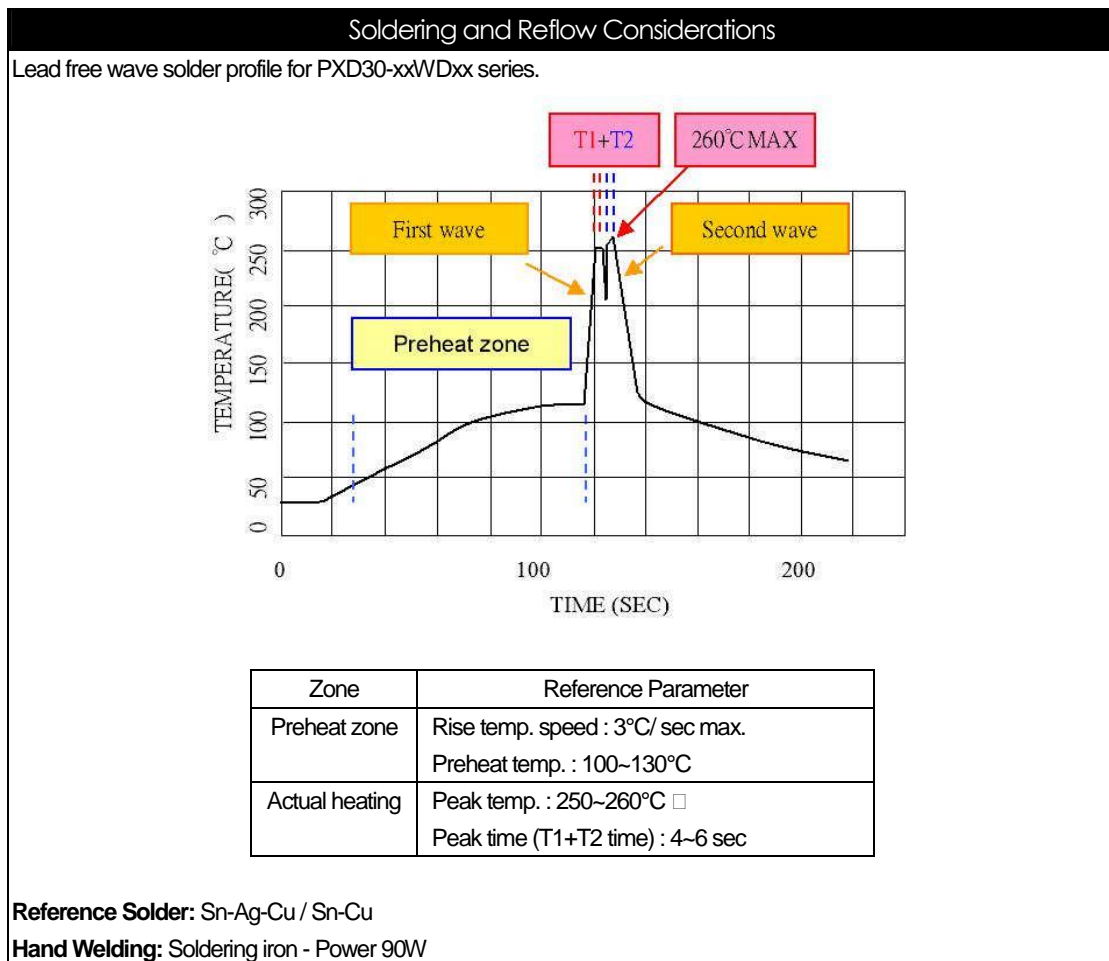
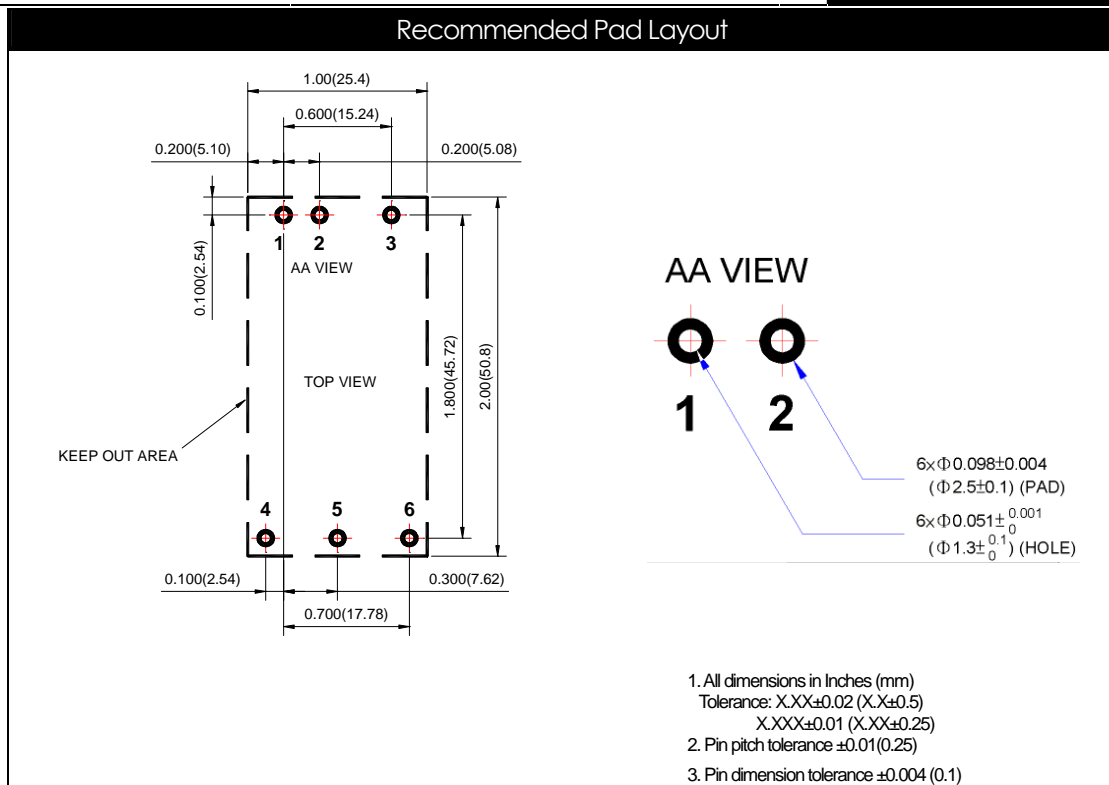

Welding Time: : 2-4 sec
Temp. : 380-400 °C

Packaging Information

TUBE

20 PCS per TUBE

TRAY

20 PCS per TRAY

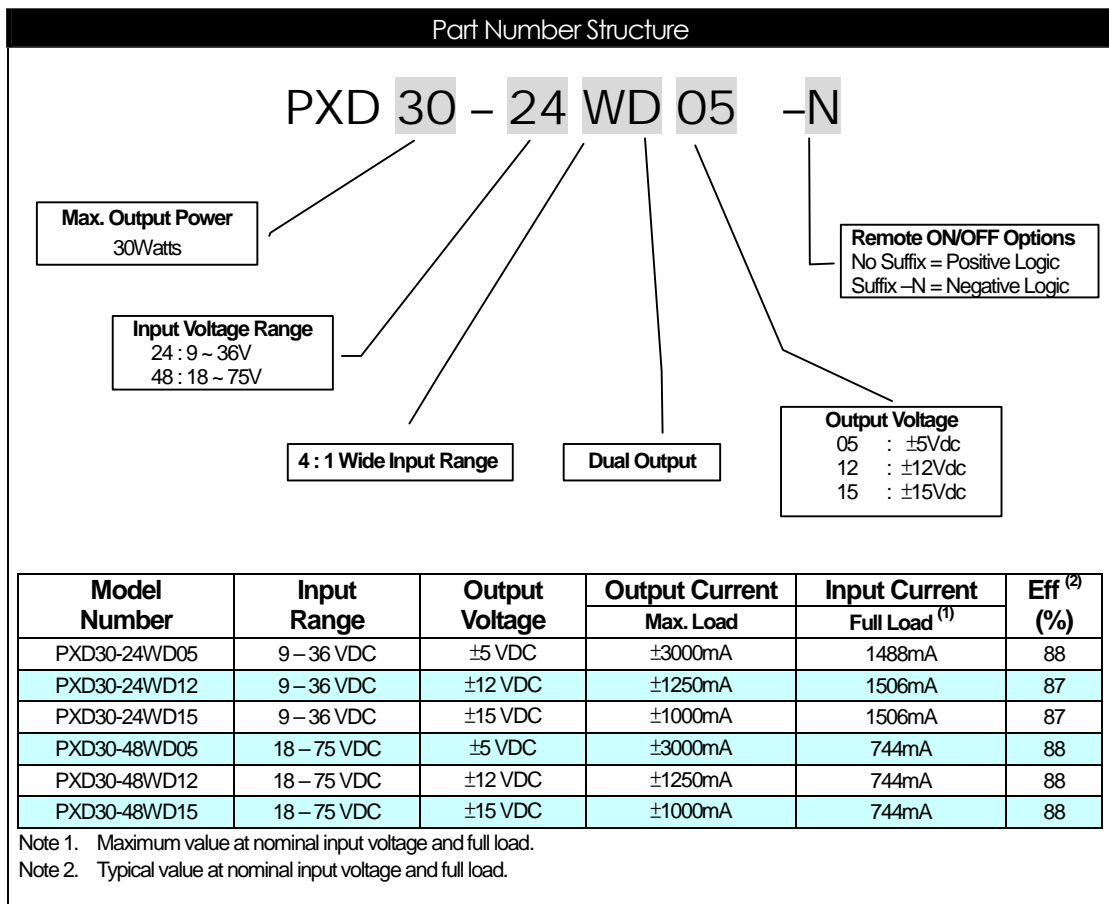

Safety and Installation Instructions

Fusing Consideration

Caution: This converter is not internally fused. An input line fuse must always be used.

This encapsulated converter can be used in a wide variety of applications, ranging from simple stand-alone operation to an integrated part of a sophisticated power architecture. For maximum flexibility, internal fusing is not included; however, to achieve maximum safety and system protection, always use an input line fuse. The safety agencies require a slow-blow fuse with a maximum rating of 10A. Based on the information provided in this data sheet on inrush energy and maximum dc input current; the same type of fuse with lower rating can be used. Refer to the fuse manufacturer's data for further information.

MTBF and Reliability

The MTBF of PXD30-xxWDxx series of DC/DC converters has been calculated using:

Bellcore TR-NWT-000332 Case I: 50% stress, Operating Temperature at 40°C °C (Ground fixed and controlled environment). The resulting figure for MTBF is 3.163×10^6 hours.

MIL-HDBK 217F NOTICE2 FULL LOAD, Operating Temperature at 25°C □. The resulting figure for MTBF is 4.347×10^5 hours.