

Battery Interconnects

Product Facts

- Total interface solution
- Current capacity — 7 Amps/ single contact at 30°C T-Rise
- Choice of right-angle or vertical mount headers with left, right or keyless polarization
- 5.0 mm pitch headers available for 7.2, 10.8, and 12.0 volt rechargeable batteries
- Receptacle connectors available with solder tails or weld tabs
- Consumer friendly mating/unmating of battery
- Produced under a Quality Management System certified to ISO 9001
- Blade Contacts for high durability
- Used Industry-wide for rechargeable battery I/O — in laptop computers
- Offered in a variety of key arrangements — for different voltage batteries
- 2.0 mm, 2.5 mm, 3.0 mm and 5.0 mm contact pitch batteries available
- MDI systems designed to mate at any angle
- Up to 7 Amps per contact
- Up to 2500 cycle durability
- Two pc tails per blade — for better current distribution



Since the introduction of the standard-size NiMH rechargeable battery to the computer and communications industries, Tyco Electronics has played a major role in the development and manufacture of reliable, high performance battery interconnect systems.

As the needs and applications of original equipment manufacturers have evolved, so have Tyco Electronics' battery interconnect systems. Today, we offer several types of connectors including:

- **Standard 5-position, 5.0 mm centerline assemblies**
- **Space efficient battery packs available at 2.0 mm, 2.5 mm, and 3.0 mm centerlines**

- **Multi-Directional Interconnection (MDI) systems**
- **Coin cell battery holders**

All battery interconnect assembly housings are made of high temperature, UL 94V-0 rated thermoplastic. Single contacts are rated at 7 Amps with a 30° T-Rise, and have an operating temperature rating of -30° to +70°C. These assemblies can be customized for various applications and are available with many keying and mounting options.

Tyco Electronics answers the need in the portable equipment market for a high density, robust, and versatile interconnection system with the Multi-Directional Interconnection

(MDI) System. This durable system, designed to permit mating/unmating at any angle between 0° and 90°, features AMP-DURAGOLD plated contacts for up to 2500 cycles.

Our coin-cell battery holders are ideal for a variety of electronic equipment needing a compact low wattage (typically less than 2 Watts) battery source. These holders are available in both horizontal and vertical mount. Surface-mount and re-flow compatible options are also ready to meet the newer PCB assembly requirements.

2.0 mm Pitch Battery Assemblies

2.0 mm Pitch Plug Assemblies

Material and Finish

Housing — Black thermoplastic resin, UL 94V-0 rated

Contacts — High conductivity copper alloy, gold plating

No. of Positions	Mount Type	Mount Angle	Part Number	Special Features
3	Surface-Mount	Vertical	1612898-1	
7	Through Hole	Right-Angle	1827654-1	Retention Leg
8	Through Hole	Right-Angle	1747785-1	
10	Surface-Mount	Vertical	2-1612962-3	Nut Plate (both sides)
	Surface-Mount	Vertical	1-1612962-3	
	Surface-Mount	Vertical	1717458-1	One side nut plate
	Through Hole	Right-Angle	1827501-1	

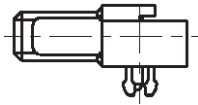
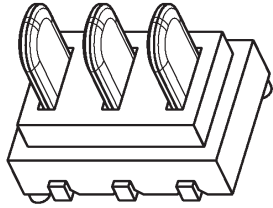

Retention Leg
(Part Number 1827654-1 Feature)

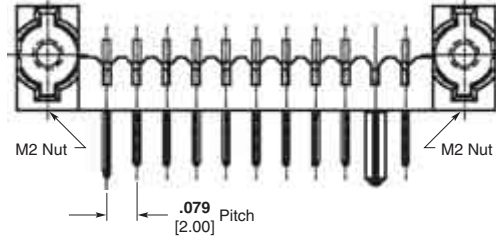

2 mm Plug Assembly with Nut Plates

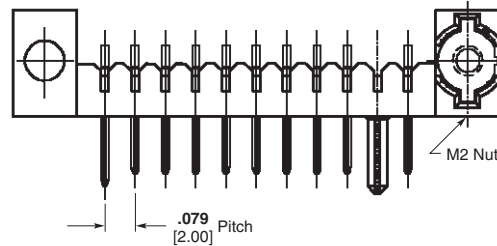

2 mm Plug Assembly with Nut Plate (One Side)

2.0 mm Pitch Receptacle Assemblies

Material and Finish

Housing — Black thermoplastic resin, UL 94V-0 rated

Contacts — High conductivity copper alloy, gold plating

No. of Positions	Mount Type	Mount Angle	Part Number
3	Surface-Mount	Vertical	1612901-1
7	Surface-Mount	Vertical	1827684-1
	Through Hole	Vertical	1827685-1
8	Surface-Mount	Vertical	1747786-1
10	Through Hole	Vertical	1612963-4
	Surface-Mount	Vertical	1612964-4

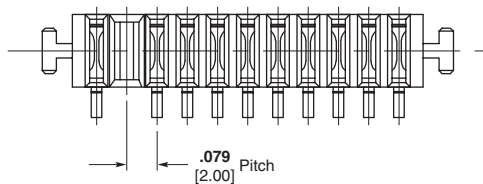
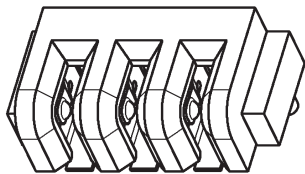

2.0 mm Receptacle Assembly,
Surface-Mount

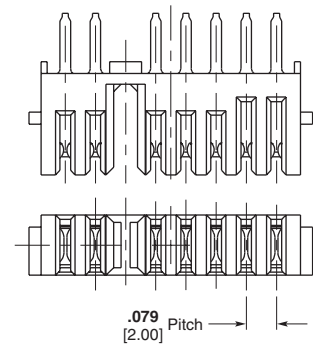

2.0 mm Receptacle Assembly,
Through Hole Mount

Note: All part numbers are RoHS compliant. Tin-lead versions are available upon request.

2.0 mm Pitch Multi-Directional Interconnection (MDI) Systems

6-Position Multi-Directional Headers

Material and Finish

Housing — Black liquid crystal polymer, UL 94V-0 rated

Contacts — Brass, plated .000030 [0.00076] min. gold on mating area, .00015 [0.0038] min. tin on solder tail, all over .000050 [0.00127] min. nickel

Mount Type	Boardlocks	Part Number	Special Features
Through Hole	With	5146877-1	Sequenced contacts
Retention Tails	Without	5787252-1	
Straight Solder		5787531-1	Sequenced contacts

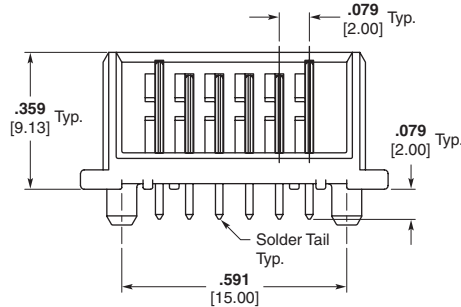

Part Number 5787531-1
Straight Solder Tails



Part Number 5787252-1
Below-the-Board Retention Tails



Part Number 5146877-1

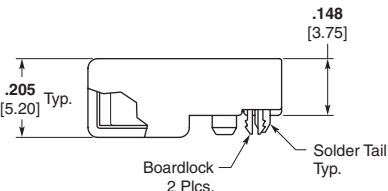

6-Position Multi-Directional Receptacles

Material and Finish

Housing — Black liquid crystal polymer, UL 94V-0 rated

Contacts — Phosphor bronze, plated .000030 [0.00076] min. gold on mating area, .00015 [0.0038] min. tin on solder tail, all over .000050 [0.00127] min. nickel

Mount Type	Boardlocks	Part Number
Surface-Mount	With	5787090-1
Through Hole	Without	5787253-1
		5787526-1



Part Number 5787253-1
Through Hole Mount

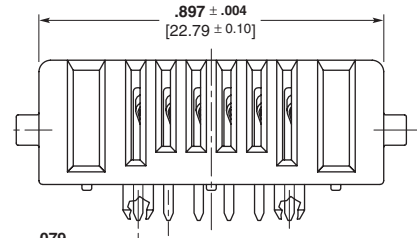

Part Number 5787526-1
Through Hole Mount



Part Number 5787090-1
Surface-Mount with Boardlocks



Note: All part numbers are RoHS compliant.

2.5 mm Pitch Battery Assemblies

2.5 mm Pitch Plug Assemblies

Material and Finish

Housing — Black thermoplastic resin, UL 94V-0 rated

Contacts — High conductivity copper alloy, gold plating

No. of Positions	Mount Type	Mount Angle	Part Number	Special Features
4	Through Hole	Right-Angle Offset	6123987-1	M2 Nut Plate
	Through Hole	Right-Angle Offset	6123978-1	
5	Through Hole	Right-Angle On Board	6376042-2	M2 Nut Plate
	Through Hole	Right-Angle On Board	9-1612503-1	
	Through Hole	Right-Angle Offset	6318792-1	
6	Through Hole	Vertical	6473451-1	
	Through Hole	Right-Angle Offset	6318977-3	M2 Nut Plate
7	Through Hole	Right-Angle On Board	6318573-4	
	Through Hole	Right-Angle On Board	1747602-1	M2 Nut Plate
8	Through Hole	Right-Angle On Board	1717445-2	
	Through Hole	Right-Angle On Board	6123738-7	
10	Through Hole	Right-Angle On Board	1123822-7	M2 Nut Plate
	Through Hole	Right-Angle On Board	1123684-7	One Side M2 Nut Plate
	Through Hole	Right-Angle Offset	6473539-7	M2 Nut Plate



Part Number 6376042-2
Right-Angle On Board Assembly
with Nut Plate

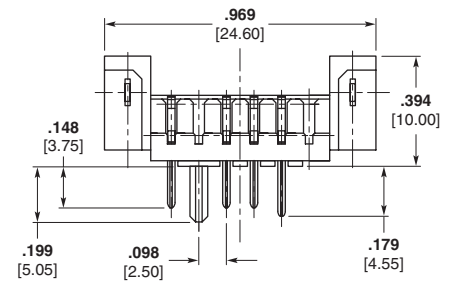

Part Number 6123978-1
Right-Angle Offset Assembly

2.5 mm Pitch Receptacle Assemblies

Material and Finish

Housing — Black thermoplastic resin, UL 94V-0 rated

Contacts — High conductivity copper alloy, gold plating

No. of Positions	Mount Type	Mount Angle	Part Number
4	Through Hole	Right-Angle	6123981-1
5	Through Hole	Right-Angle	6318430-2
	Surface-Mount	Right-Angle	1612504-1
6	Surface-Mount	Vertical	1123688-3
7	Surface-Mount	Vertical	1318574-4
8	Through Hole	Vertical	1717478-1
	Through Hole	Right-Angle	1717620-1
10	Surface-Mount	Vertical	1123688-7
	Through Hole	Vertical	1674231-1

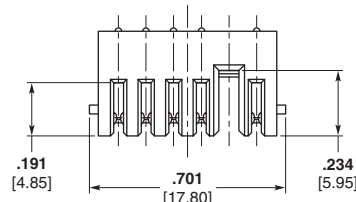

Part Number 6318430-2
Right-Angle Through Hole Mount

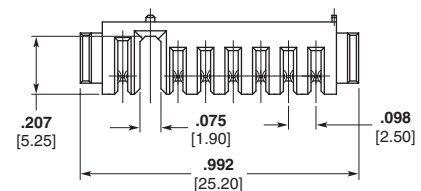

Part Number 1318574-4
Vertical Surface-Mount

Note: All part numbers are RoHS compliant.

5.0 mm Pitch Battery Plug Assemblies

5.0 mm Pitch Right-Hand Key Plug Assemblies



Material and Finish

Housing — Polyphthalamide, UL 94V-0 rated, black

Contacts — Brass, plated .000100 [0.00254] min. tin on solder tail over .000075 [0.00190] min. nickel overall

Voltage	Mount Type	Mount Angle	Part Number
12.0	Retentive Solder	Right-Angle	5787424-1
	Straight Solder	Right-Angle	5787422-1
	Straight Solder	Vertical	5787430-1
10.8	Retentive Solder	Vertical	5787421-1
	Straight Solder	Vertical	5787419-1
7.2	Retentive Solder	Right-Angle	5787141-1
	Straight Solder	Vertical	5787334-1
	Straight Solder	Right-Angle	5787142-1

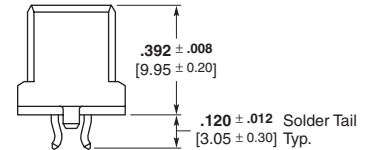
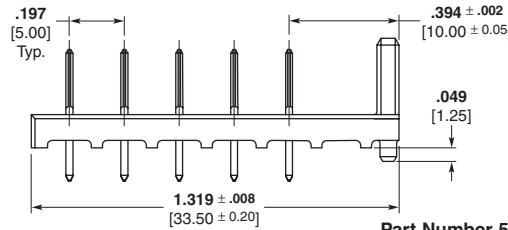

Part Number 5787421-1
Vertical Assembly with Retentive Tails

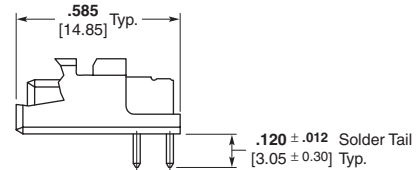
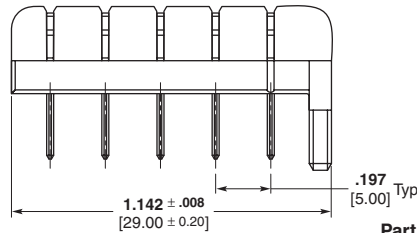

Part Number 5787142-1
Right-Angle Assembly with Straight Tails

5.0 mm Pitch Left-Hand Key Plug Assemblies



Material and Finish

Housing — Polyphthalamide, UL 94V-0 rated, black

Contacts — Brass, plated .000100 [0.00254] min. tin on solder tail over .000075 [0.00190] min. nickel overall

Voltage	Mount Type	Mount Angle	Part Number	Special Features
12.0	Straight Solder	Right-Angle	5787428-1	Mounting Holes
10.8	Retentive Solder	Right-Angle	5787418-1	
	Straight Solder	Right-Angle	5787246-1	

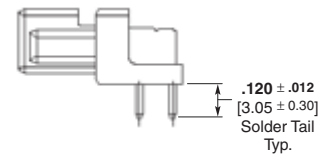
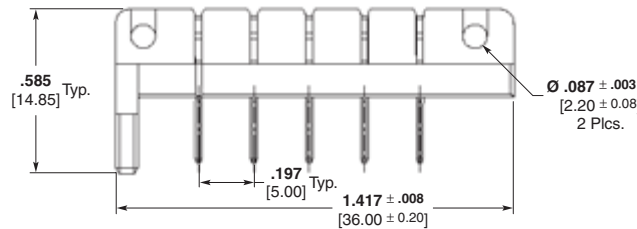

Part Number 5787428-1
Right-Angle Assembly with Mounting Holes

5.0 mm Pitch Keyless Plug Assemblies



Material and Finish

Housing — Polyphthalamide, UL 94V-0 rated, black

Contacts — Brass, plated .000100 [0.00254] min. tin on solder tail over .000075 [0.00190] min. nickel overall

Voltage	Mount Type	Mount Angle	Part Number	Special Features
N/A	Straight Solder	Right-Angle	5787441-1	
	Retentive Solder	Right-Angle	5787443-1	
	Straight Solder	Right-Angle	5796078-1	Sequenced Contacts
	Retentive Solder	Vertical	5787446-1	
	Straight Solder	Vertical	5787444-1	

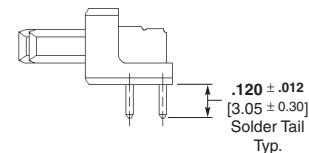
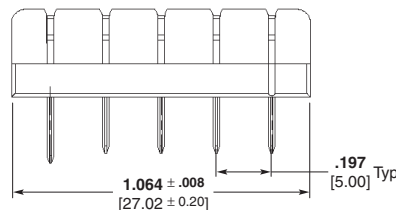

Part Number 5796078-1
Right-Angle Assembly with Straight Tails & Sequenced Contacts

Note: All part numbers are RoHS compliant.

5.0 mm Pitch Battery Receptacle Assemblies

5.0 mm Pitch Right-Hand Key Receptacle Assemblies

Material and Finish

Housing — Black polycarbonate, UL 94V-0 rated

Contacts — Copper alloy, plated .000075 [0.00190] min. nickel

Voltage	Mount Type	Part Number
12.0	Surface-Mount	787439-1
	Weld Tabs	787615-1
10.8	Weld Tabs	787614-1

Note: All receptacles include a dovetail locator.

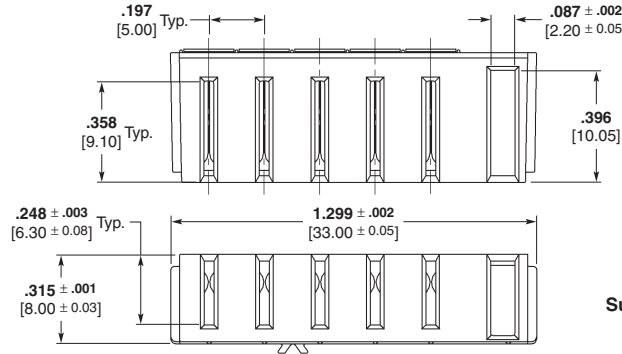

Part Number 787439-1
Surface-Mount Receptacle

5.0 mm Pitch Left-Hand Key Receptacle Assemblies

Material and Finish

Housing — Black polycarbonate, UL 94V-0 rated

Contacts — Copper alloy, plated .000075 [0.00190] min. nickel

Voltage	Mount Type	Part Number
7.2	Solder Tail	5787590-1
	Surface-Mount	787328-1
	Weld Tab	787613-1

Note: All receptacles include a dovetail locator.

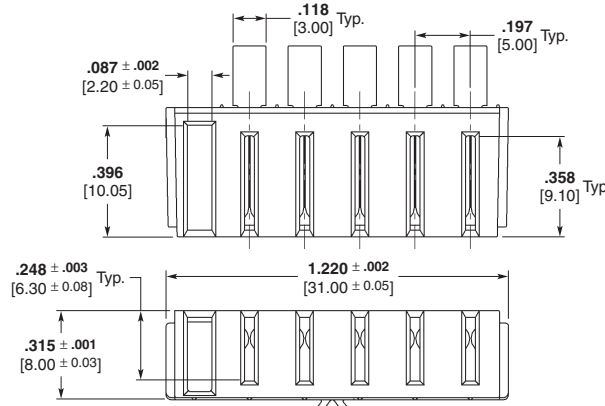

Part Number 787613-1
Weld Tab Receptacle

5.0 mm Pitch Keyless Receptacle Assemblies

Material and Finish

Housing — Black polycarbonate, UL 94V-0 rated

Contacts — Copper alloy, plated .000075 [0.00190] min. nickel

Voltage	Mount Type	Part Number
N/A	Solder Tail	5787802-1
	Surface-Mount	146845-1

Note: All receptacles include a dovetail locator.



Part Number 5787802-1
Solder Tail Receptacle

Note: All part numbers are RoHS compliant.

Coin Cell Battery Holders

Horizontal Mount Battery Holders

Material and Finish

Housing — Black thermoplastic resin, UL 94V-0 rated



Mount Type	Part Number	Special Features
Surface-Mount	796136-1	
Through Hole	1734178-1	Flexible housing for easy removal
	120591-1	



Part Number 120591-1
Through Hole Mount



Part Number 796136-1
Surface-Mount

Vertical Mount Battery Holders

Material and Finish

Housing — Black thermoplastic resin, UL 94V-0 rated

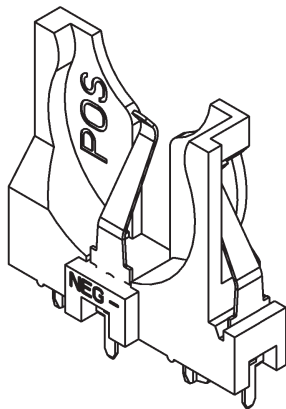

Mount Type	Part Number	Special Features
Through Hole	6339488-1	
	1775485-1	Low Profile

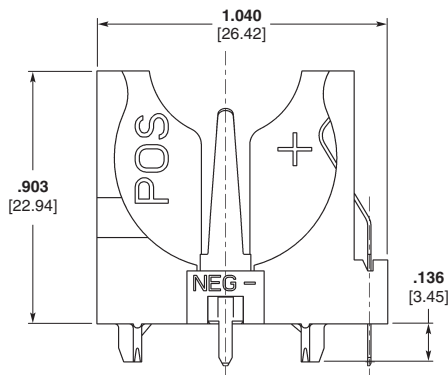

Part Number 6339488-1

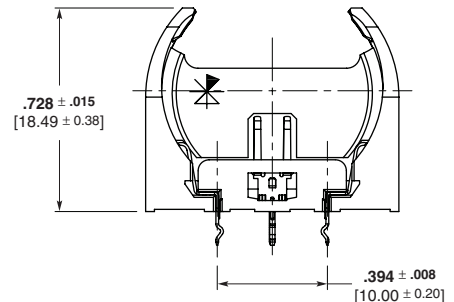

Part Number 1775485-1
Low Profile

Note: All part numbers are RoHS compliant.

DC Power Jacks

Product Facts

- Low Profile Design
- Accepts industry standard DC power plugs
- Available with:
 - Solder tabs
 - Through-hole solder tails
 - SMT leads
- Available to accept these plug sizes:
 - 0.65 mm
 - 1.0 mm
 - 1.3 mm
 - 1.47 mm
 - 1.87 mm
 - 2.0 mm
 - 2.35 mm
 - 2.5 mm
- Ideal for portable electric devices



Surface-Mount Power Jacks

Pin Diameters — 0.65 mm and 1.3 mm

Part Number 1775638-1

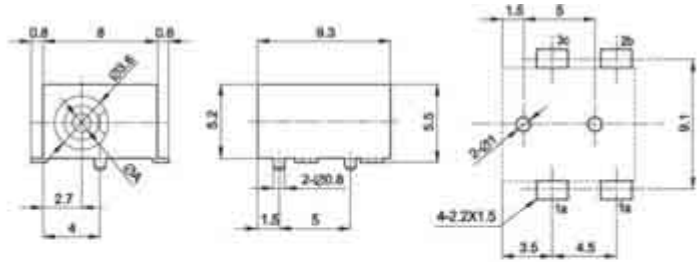

Bottom View

CENTER PIN DIAMETER: A	1.3 DIA
SCHMATIC	

Part Number 1775639-1

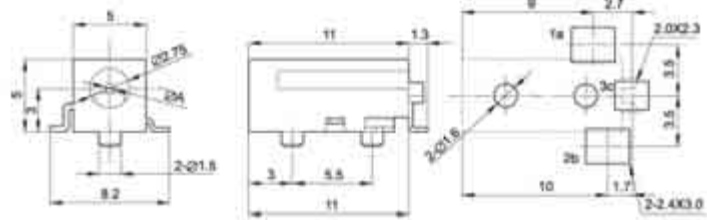

Bottom View

CENTER PIN DIAMETER: A	0.65 DIA
SCHMATIC	

Vertical DC Jack

Part Number 1470390-1

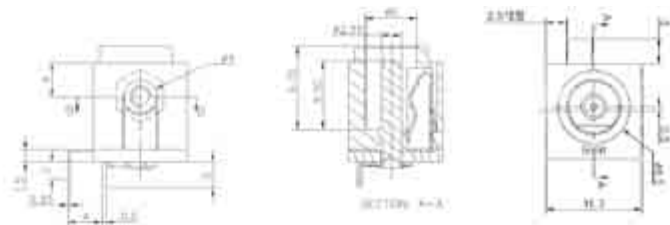

Note: All part numbers are RoHS compliant.

DC Power Jacks (Continued)

Right-Angle DC Jacks Miniature Jacks

For specific part numbers, contact Tyco Electronics

Center Dia.	Tail Length	Part Number
1.30	3.00	1775529-1
	1.50	1775529-2
1.00	3.00	1-1775529-1
	1.50	1-1775529-2



CENTER PIN DIAMETER/A	1.3 DIA		1.0 DIA		1.3 DIA	
B LENGTH	3.0mm	1.5mm	3.0mm	1.5mm	3.0mm	1.5mm
SCHEMATIC						

Shielded Jack

Dia. A	N.W. (q)	Part Number
2.0	1.8	1734894-1
2.5	2.0	1734894-2

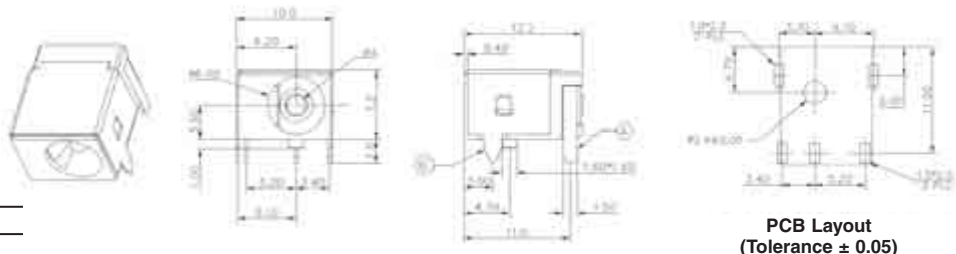

PCB Layout (Tolerance ± 0.05)

Standard Jacks

Center Diameter	Part Number
2.00	1775069-1
2.35	1775069-2
2.50	1775069-3



CENTER PIN DIAMETER/A	1.35 DIA	1.47 DIA	1.7 DIA	1.87 DIA	2.0 DIA	2.2 DIA	2.35 DIA	2.5 DIA
SCHEMATIC								

Standard Jack — Recessed Flange

For specific part numbers, contact Tyco Electronics

Center Diameter	Part Number
1.47	1775637-1
1.87	1775637-2
2.00	1775637-3
2.35	1775637-4
2.45	1775637-5

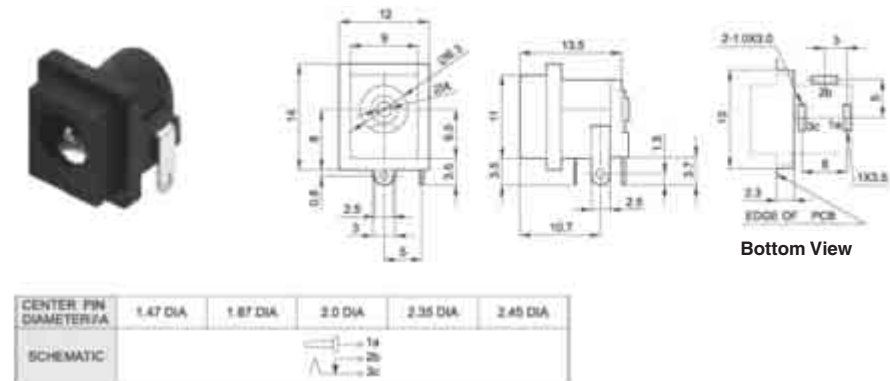

Bottom View

CENTER PIN DIAMETER/A	1.47 DIA	1.87 DIA	2.0 DIA	2.35 DIA	2.45 DIA
SCHEMATIC					

Note: All part numbers are RoHS compliant.

Mouser Electronics

Authorized Distributor

Click to View Pricing, Inventory, Delivery & Lifecycle Information:

[TE Connectivity:](#)

[6339488-1](#)