



## WP59SURKSGW T-1 3/4 (5mm) Bi-Color Indicator Lamp

### DESCRIPTIONS

- The Hyper Red source color devices are made with AlGaInP on GaAs substrate Light Emitting Diode
- The Super Bright Green source color devices are made with Gallium Phosphide Green Light Emitting Diode
- Electrostatic discharge and power surge could damage the LEDs
- It is recommended to use a wrist band or anti-electrostatic glove when handling the LEDs
- All devices, equipments and machineries must be electrically grounded

### FEATURES

- Uniform light output
- Low power consumption
- 3 leads with one common lead
- Long life-solid state reliability
- RoHS compliant

### APPLICATIONS

- Status indicator
- Illuminator
- Signage applications
- Decorative and entertainment lighting
- Commercial and residential architectural lighting

### ATTENTION

Observe precautions for handling electrostatic discharge sensitive devices



### PACKAGE DIMENSIONS

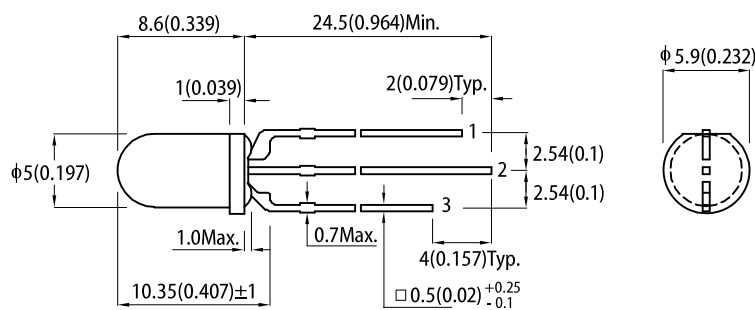

#### Recommended PCB Layout

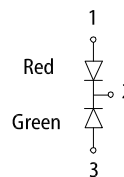
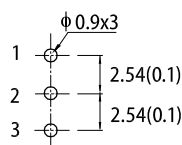

1 Anode Red  
2 Common Cathode  
3 Anode Green

#### Notes:

1. All dimensions are in millimeters (inches).
2. Tolerance is  $\pm 0.25 (0.01")$  unless otherwise noted.
3. Lead spacing is measured where the leads emerge from the package.
4. The specifications, characteristics and technical data described in the datasheet are subject to change without prior notice.

### SELECTION GUIDE

| Part Number | Emitting Color (Material)                                     | Lens Type      | Iv (mcd) @ 20mA <sup>[2]</sup> |      | Viewing Angle <sup>[1]</sup> |
|-------------|---|----------------|--------------------------------|------|------------------------------|
|             |   |                | Min.                           | Typ. | 201/2                        |
| WP59SURKSGW | <span style="color: red;">■</span> Hyper Red (AlGaInP)        | White Diffused | 700                            | 1400 | 30°                          |
|             |   |                | *200                           | *400 |                              |
|             | 20  |                | 60                             |      |                              |
|             | *20   |                | *60                            |      |                              |
|             | <span style="color: green;">■</span> Super Bright Green (GaP) |                |                                |      |                              |

Notes:  
 1.  $\theta 1/2$  is the angle from optical centerline where the luminous intensity is 1/2 of the optical peak value.  
 2. Luminous intensity / luminous flux:  $\pm 15\%$ .  
 \* Luminous intensity value is traceable to CIE127-2007 standards.

**ELECTRICAL / OPTICAL CHARACTERISTICS at T<sub>A</sub>=25°C**

| Parameter  | Symbol                          | Emitting Color                  | Value       |            | Unit |
|--|---------------------------------|---------------------------------|-------------|------------|------|
|  |                                 |                                 | Typ.        | Max.       |      |
| Wavelength at Peak Emission I <sub>F</sub> = 20mA            | λ <sub>peak</sub>               | Hyper Red<br>Super Bright Green | 645<br>565  | -          | nm   |
| Dominant Wavelength I <sub>F</sub> = 20mA                    | λ <sub>dom</sub> <sup>[1]</sup> | Hyper Red<br>Super Bright Green | 630<br>568  | -          | nm   |
| Spectral Bandwidth at 50% Φ REL MAX<br>I <sub>F</sub> = 20mA | Δλ                              | Hyper Red<br>Super Bright Green | 28<br>30    | -          | nm   |
| Capacitance  | C                               | Hyper Red<br>Super Bright Green | 35<br>15    | -          | pF   |
| Forward Voltage I <sub>F</sub> = 20mA                        | V <sub>F</sub> <sup>[2]</sup>   | Hyper Red<br>Super Bright Green | 1.95<br>2.2 | 2.5<br>2.5 | V    |
| Reverse Current (V <sub>R</sub> = 5V)                        | I <sub>R</sub>                  | Hyper Red<br>Super Bright Green | -           | 10<br>10   | uA   |

## Notes:

1. The dominant wavelength (λ<sub>d</sub>) above is the setup value of the sorting machine. (Tolerance λ<sub>d</sub> : ±1nm.)
2. Forward voltage: ±0.1V.
3. Wavelength value is traceable to CIE127-2007 standards.
4. Excess driving current and / or operating temperature higher than recommended conditions may result in severe light degradation or premature failure.

**ABSOLUTE MAXIMUM RATINGS at T<sub>A</sub>=25°C**

| Parameter                               | Symbol                         | Value               |                    | Unit |
|---|--------------------------------|---------------------|--------------------|------|
|   |                                | Hyper Red           | Super Bright Green |      |
| Power Dissipation                       | P <sub>D</sub>                 | 75                  | 62.5               | mW   |
| Reverse Voltage                         | V <sub>R</sub>                 | 5                   | 5                  | V    |
| Junction Temperature                    | T <sub>j</sub>                 | 115                 | 110                | °C   |
| Operating Temperature                   | T <sub>op</sub>                | -40 to +85          |                    | °C   |
| Storage Temperature                     | T <sub>stg</sub>               | -40 to +85          |                    | °C   |
| DC Forward Current                      | I <sub>F</sub>                 | 30                  | 25                 | mA   |
| Peak Forward Current                    | I <sub>FM</sub> <sup>[1]</sup> | 185                 | 140                | mA   |
| Electrostatic Discharge Threshold (HBM) | -                              | 3000                | 8000               | V    |
| Lead Solder Temperature <sup>[2]</sup>  |                                | 260°C For 3 Seconds |                    |      |
| Lead Solder Temperature <sup>[3]</sup>  |                                | 260°C For 5 Seconds |                    |      |

## Notes:

1. 1/10 Duty Cycle, 0.1ms Pulse Width.
2. 2mm below package base.
3. 5mm below package base.
4. Relative humidity levels maintained between 40% and 60% in production area are recommended to avoid the build-up of static electricity – Ref JEDEC/JESD625-A and JEDEC/J-STD-033.

## TECHNICAL DATA

### RELATIVE INTENSITY vs. WAVELENGTH

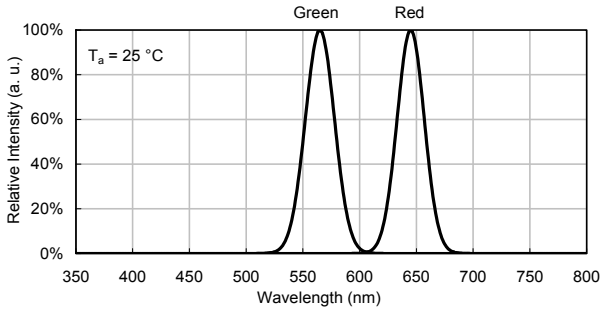

### SPATIAL DISTRIBUTION

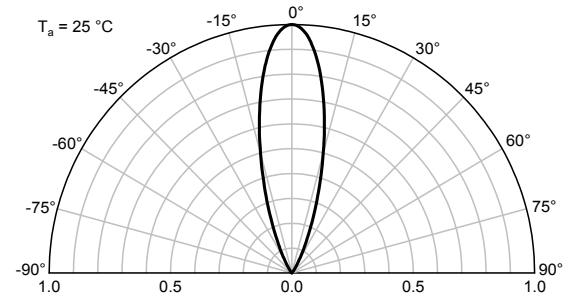

## HYPER RED

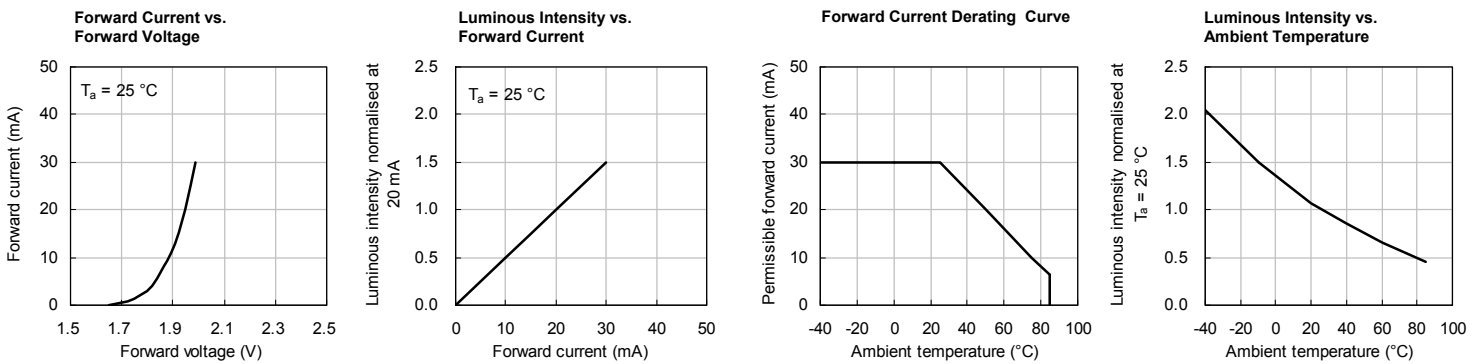

## SUPER BRIGHT GREEN

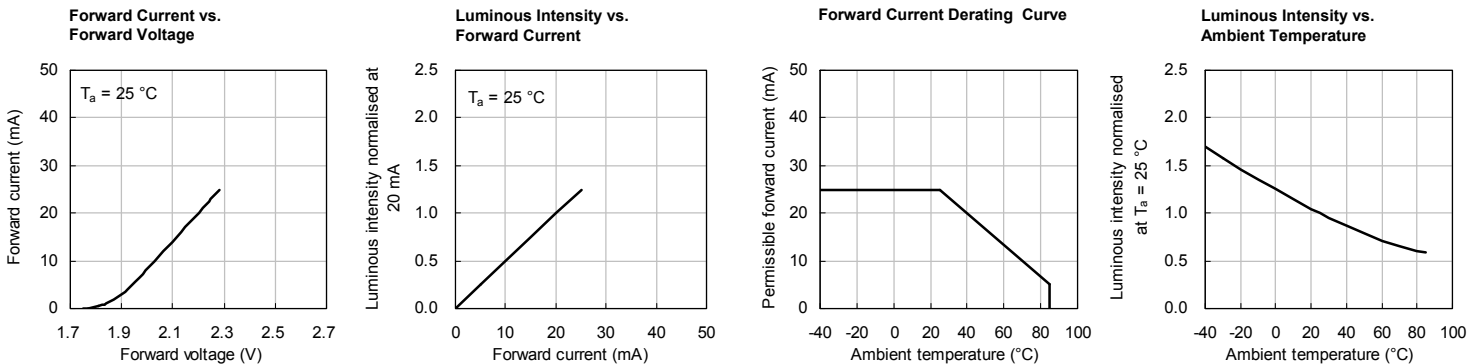

### RECOMMENDED WAVE SOLDERING PROFILE

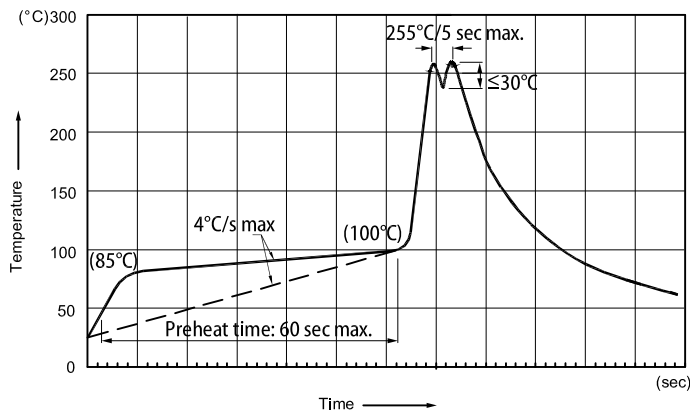

- Notes:
1. Recommend pre-heat temperature of 105°C or less (as measured with a thermocouple attached to the LED pins) prior to immersion in the solder wave with a maximum solder bath temperature of 260°C
  2. Peak wave soldering temperature between 245°C ~ 255°C for 3 sec (5 sec max).
  3. Do not apply stress to the epoxy resin while the temperature is above 85°C.
  4. Fixtures should not incur stress on the component when mounting and during soldering process.
  5. SAC 305 solder alloy is recommended.
  6. No more than one wave soldering pass.

## PACKING & LABEL SPECIFICATIONS

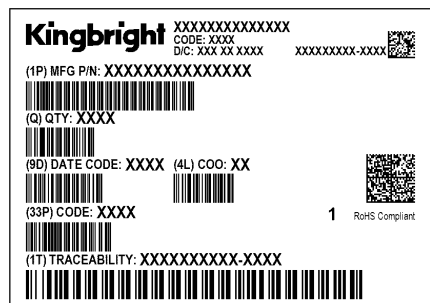
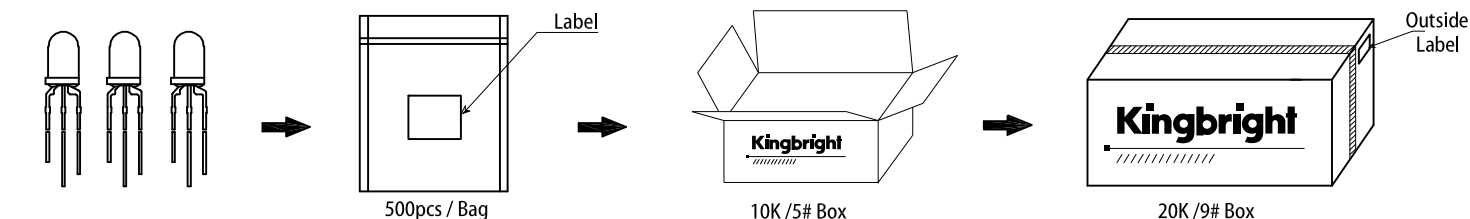

## PRECAUTIONS

### Storage conditions

1. Avoid continued exposure to the condensing moisture environment and keep the product away from rapid transitions in ambient temperature.
2. LEDs should be stored with temperature  $\leq 30^{\circ}\text{C}$  and relative humidity  $< 60\%$ .
3. Product in the original sealed package is recommended to be assembled within 72 hours of opening.  
 Product in opened package for more than a week should be baked for 30 (+10/-0) hours at  $85 \sim 100^{\circ}\text{C}$ .

### LED Mounting Method

1. The lead pitch of the LED must match the pitch of the mounting holes on the PCB during component placement.  
 Lead-forming may be required to insure the lead pitch matches the hole pitch.  
 Refer to the figure below for proper lead forming procedures.

Note 1-3: Do not route PCB trace in the contact area between the leadframe and the PCB to prevent short-circuits.

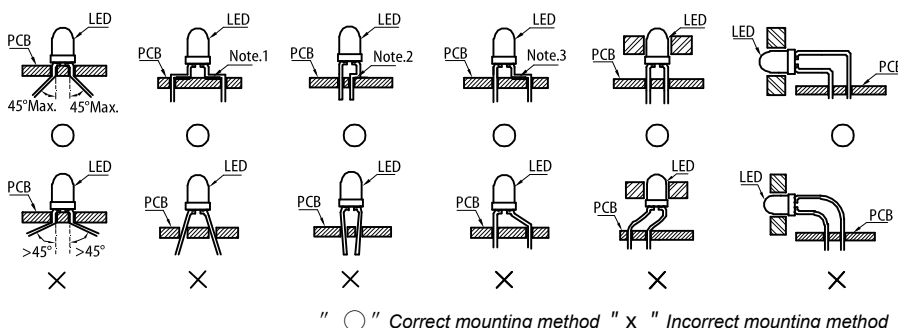

2. When soldering wires to the LED, each wire joint should be separately insulated with heat-shrink tube to prevent short-circuit contact.  
 Do not bundle both wires in one heat shrink tube to avoid pinching the LED leads. Pinching stress on the LED leads may damage the internal structures and cause failure.

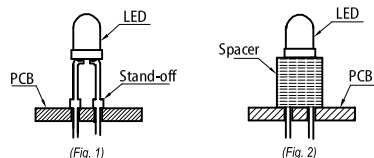
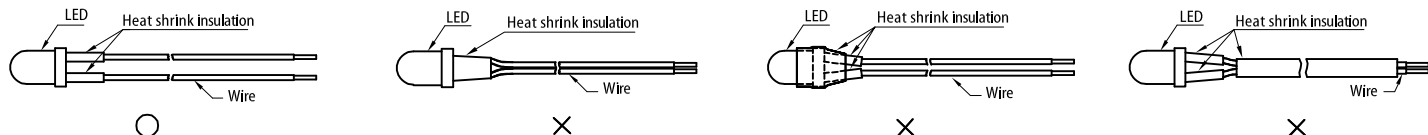

3. Use stand-offs (Fig. 1) or spacers (Fig. 2) to securely position the LED above the PCB.
4. Maintain a minimum of 3mm clearance between the base of the LED lens and the first lead bend (Fig. 3, Fig. 4).
5. During lead forming, use tools or jigs to hold the leads securely so that the bending force will not be transmitted to the LED lens and its internal structures. Do not perform lead forming once the component has been mounted onto the PCB. (Fig. 5)

### Lead Forming Procedures

1. Do not bend the leads more than twice. (Fig. 6)
2. During soldering, component covers and holders should leave clearance to avoid placing damaging stress on the LED during soldering. (Fig. 7)
3. The tip of the soldering iron should never touch the lens epoxy.
4. Through-hole LEDs are incompatible with reflow soldering.
5. If the LED will undergo multiple soldering passes or face other processes where the part may be subjected to intense heat, please check with Kingbright for compatibility.

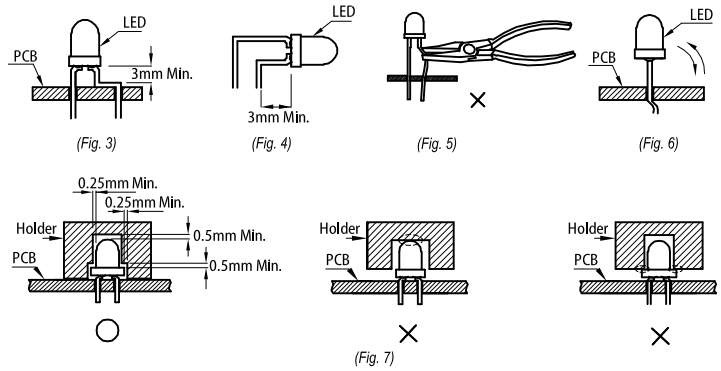

### PRECAUTIONARY NOTES

1. The information included in this document reflects representative usage scenarios and is intended for technical reference only.
2. The part number, type, and specifications mentioned in this document are subject to future change and improvement without notice. Before production usage customer should refer to the latest datasheet for the updated specifications.
3. When using the products referenced in this document, please make sure the product is being operated within the environmental and electrical limits specified in the datasheet. If customer usage exceeds the specified limits, Kingbright will not be responsible for any subsequent issues.
4. The information in this document applies to typical usage in consumer electronics applications. If customer's application has special reliability requirements or have life-threatening liabilities, such as automotive or medical usage, please consult with Kingbright representative for further assistance.
5. The contents and information of this document may not be reproduced or re-transmitted without permission by Kingbright.
6. All design applications should refer to Kingbright application notes available at <http://www.KingbrightUSA.com/ApplicationNotes>

# Mouser Electronics

Authorized Distributor

Click to View Pricing, Inventory, Delivery & Lifecycle Information:

[Kingbright:](#)

[WP59SURKSGW](#)