

10 9 8 7 6 5 4 3 2 1

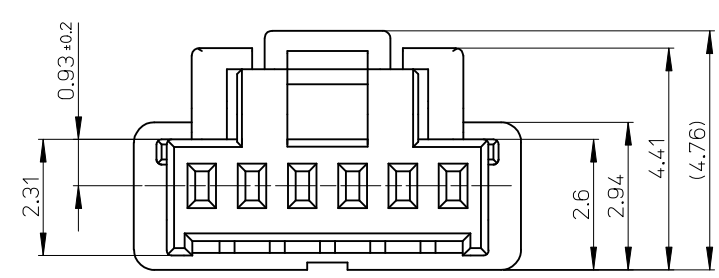

VIEW "D"

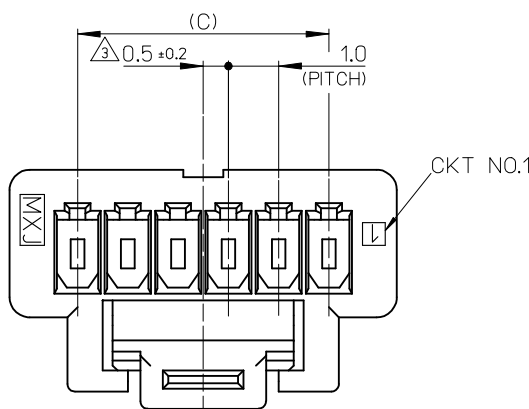
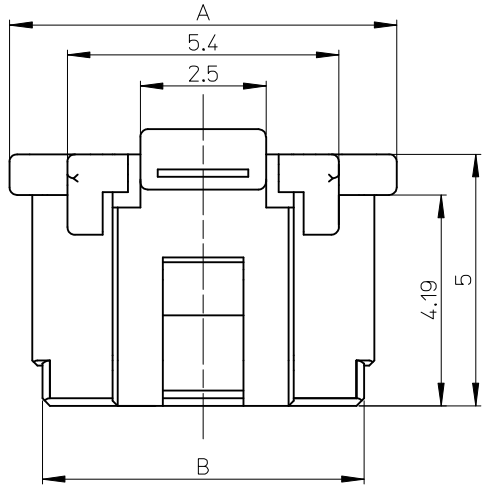

VIEW D

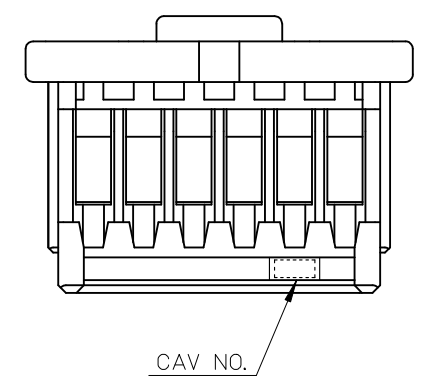
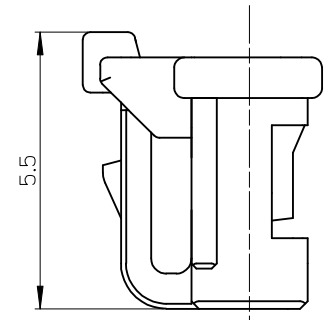

- NOTES.
- 適合ターミナル : 501334-****
APPLICABLE TERMINAL : 501334-****
 - 嵌合相手 : 501331-****
MATE WITH : 501331-****
 - 偶数極に適用
APPLY FOR EVEN CIRCUIT SIZE
 - 2~5極は、SD-501330-001を参照下さい。
REFER TO SD-501330-001 ABOUT 2-5CKT.
 - ELV 及び RoHS適合品
ELV AND RoHS COMPLIANT.
 - 材質
MATERIAL
66ナイロン 66NYLON
ガラス無充填 GLASS FILLED 0%
UL94V-0

※対応可能な極数は、別途お問い合わせ下さい。

14.0	15.4	16.7	501330-15**	15	501330-**0* 501330-**3*
13.0	14.4	15.7	501330-14**	14	
12.0	13.4	14.7	501330-13**	13	
11.0	12.4	13.7	501330-12**	12	
10.0	11.4	12.7	501330-11**	11	
9.0	10.4	11.7	501330-10**	10	
8.0	9.4	10.7	501330-09**	9	
7.0	8.4	9.7	501330-08**	8	
6.0	7.4	8.7	501330-07**	7	
5.0	6.4	7.7	501330-06**	6	
C	B	A	MATERIAL NO.	CKT.	MODEL NO.

REVISED EC NO. J2016-0342 DRW:KMATSUYAMA 2015/10/02 CHKD:KASAKAWA 2015/10/02 APPR:NUKITA 2015/10/02	GENERAL TOLERANCES (UNLESS SPECIFIED)		DIMENSION STYLE MM ONLY		SCALE 10:1	DESIGN UNITS METRIC	THIRD ANGLE PROJECTION
	0.25 UNDER	±0.03	DRAWN BY NYOSHIDA	DATE 2004/07/30	TITLE 1.0 WIRE TO BOARD CONN. 1-ROW RECEPTACLE HOUSING 6-15CKT.		
	0.25 OVER 0.5 UNDER	±0.05	CHECKED BY MYAGI	DATE 2004/07/30			
	0.5 OVER 1.0 UNDER	±0.1	APPROVED BY NUKITA	DATE 2015/10/02			
	1.0 OVER 30 UNDER	±0.25	MATERIAL NO.	SEE TABLE	DOCUMENT NO. SD-501330-002	SHEET NO. 1 OF 2	THIS DRAWING CONTAINS INFORMATION THAT IS PROPRIETARY TO MOLEX INCORPORATED AND SHOULD NOT BE USED WITHOUT WRITTEN PERMISSION
30 OVER	±0.3	DRAFT WHERE APPLICABLE MUST REMAIN WITHIN DIMENSIONS		SIZE A3			

9 8 7 6 5 4 3 2 1

紫 VIOLET	橙 ORANGE	茶 BROWN	緑 GREEN	青 BLUE	黄 YELLOW	赤 RED	黒 BLACK	色 COLOR	
501330-1539	501330-1538	501330-1537	501330-1536	501330-1534	501330-1533	501330-1532	501330-1531	15	501330-***3*
501330-1439	501330-1438	501330-1437	501330-1436	501330-1434	501330-1433	501330-1432	501330-1431	14	
501330-1339	501330-1338	501330-1337	501330-1336	501330-1334	501330-1333	501330-1332	501330-1331	13	
501330-1239	501330-1238	501330-1237	501330-1236	501330-1234	501330-1233	501330-1232	501330-1231	12	
501330-1139	501330-1138	501330-1137	501330-1136	501330-1134	501330-1133	501330-1132	501330-1131	11	
501330-1039	501330-1038	501330-1037	501330-1036	501330-1034	501330-1033	501330-1032	501330-1031	10	
501330-0939	501330-0938	501330-0937	501330-0936	501330-0934	501330-0933	501330-0932	501330-0931	9	
501330-0839	501330-0838	501330-0837	501330-0836	501330-0834	501330-0833	501330-0832	501330-0831	8	
501330-0739	501330-0738	501330-0737	501330-0736	501330-0734	501330-0733	501330-0732	501330-0731	7	
501330-0639	501330-0638	501330-0637	501330-0636	501330-0634	501330-0633	501330-0632	501330-0631	6	
MATERIAL NO.	MATERIAL NO.	MATERIAL NO.	MATERIAL NO.	MATERIAL NO.	MATERIAL NO.	MATERIAL NO.	MATERIAL NO.	CKT.	MODEL NO.

白 WHITE	色 COLOR	
501330-1500	15	501330-***00
501330-1400	14	
501330-1300	13	
501330-1200	12	
501330-1100	11	
501330-1000	10	
501330-0900	9	
501330-0800	8	
501330-0700	7	
501330-0600	6	
MATERIAL NO.	CKT.	MODEL NO.

REVISED EC NO: J2016-0342 DRINKMATSUYAMA 2015/10/02 CHKD:KASAKAWA 2015/10/02 APPR:NUKITA 2015/10/02	GENERAL TOLERANCES (UNLESS SPECIFIED)		DIMENSION STYLE MM ONLY		SCALE 10:1	DESIGN UNITS METRIC	THIRD ANGLE PROJECTION	
	0.25 UNDER	± 0.03	DRAWN BY	DATE	TITLE 1.0 WIRE TO BOARD CONN. 1-ROW RECEPTACLE HOUSING 6-15CKT.			
	0.25 OVER 0.5 UNDER	± 0.05	NYOSHIDA	2004/07/30				
	0.5 OVER 1.0 UNDER	± 0.1	CHECKED BY	DATE	DOCUMENT NO. molex SD-501330-002			
	1.0 OVER 10 UNDER	± 0.2	MYAGI	2004/07/30				
10 OVER 30 UNDER	± 0.25	APPROVED BY	DATE	SHEET NO. 2 OF 2				
30 OVER	± 0.3	NUKITA	2015/10/02					
ANGULAR ±3 °		MATERIAL NO.	SEE TABLE					
DRAFT WHERE APPLICABLE MUST REMAIN WITHIN DIMENSIONS			SIZE A3	THIS DRAWING CONTAINS INFORMATION THAT IS PROPRIETARY TO MOLEX INCORPORATED AND SHOULD NOT BE USED WITHOUT WRITTEN PERMISSION				

10 9 8 7 6 5 4 3 2 1

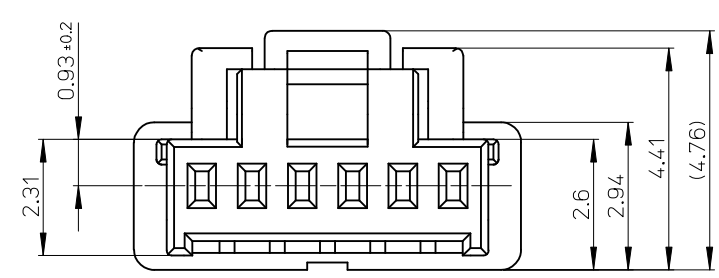
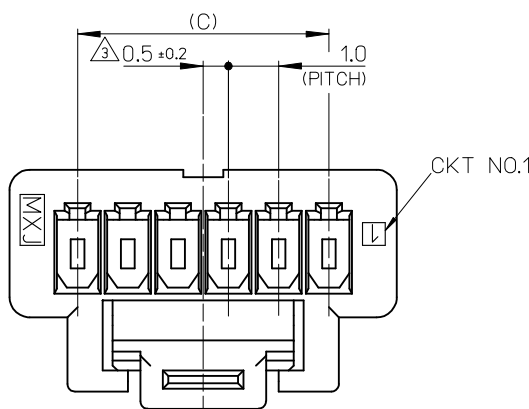

VIEW "D"

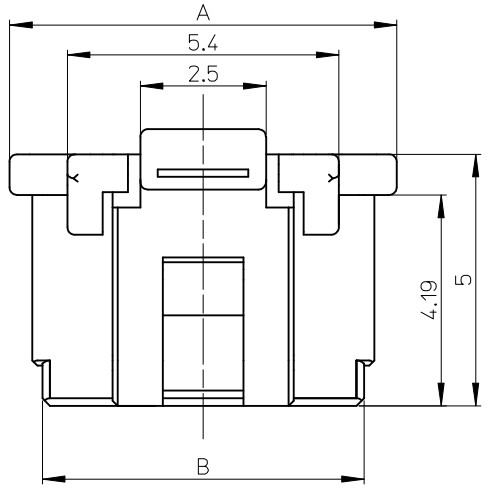

VIEW D

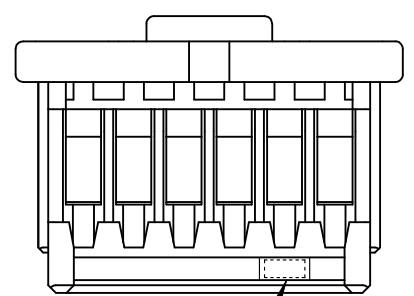
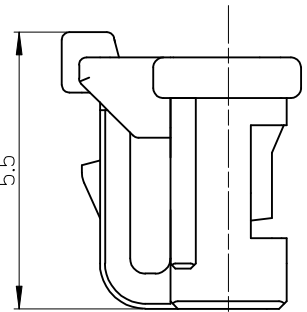

NOTES.

- 適合ターミナル : 501334-****
APPLICABLE TERMINAL : 501334-****
- 嵌合相手 : 501331-****
MATE WITH : 501331-****
- 偶数極に適用
APPLY FOR EVEN CIRCUIT SIZE
- 2~5極は、SD-501330-001を参照下さい。
REFER TO SD-501330-001 ABOUT 2-5CKT.
- ELV 及び RoHS適合品
ELV AND RoHS COMPLIANT.
- 材質
MATERIAL
66ナイロン 66NYLON
ガラス無充填 GLASS FILLED 0%
UL94V-0

※対応可能な極数は、別途お問い合わせ下さい。

14.0	15.4	16.7	501330-15**	15	501330-**0* 501330-**3*
13.0	14.4	15.7	501330-14**	14	
12.0	13.4	14.7	501330-13**	13	
11.0	12.4	13.7	501330-12**	12	
10.0	11.4	12.7	501330-11**	11	
9.0	10.4	11.7	501330-10**	10	
8.0	9.4	10.7	501330-09**	9	
7.0	8.4	9.7	501330-08**	8	
6.0	7.4	8.7	501330-07**	7	
5.0	6.4	7.7	501330-06**	6	
C	B	A	MATERIAL NO.	CKT.	MODEL NO.

REVISED EC NO. J2016-0342 DRW: NIKIMATSUYAMA 2015/10/02 CHKD: KASAKAWA 2015/10/02 APPR: NUKITA 2015/10/02	GENERAL TOLERANCES (UNLESS SPECIFIED)		DIMENSION STYLE MM ONLY		SCALE 10:1	DESIGN UNITS METRIC	THIRD ANGLE PROJECTION
	0.25 UNDER	± 0.03	DRAWN BY NYOSHIDA	DATE 2004/07/30	TITLE 1.0 WIRE TO BOARD CONN. 1-ROW RECEPTACLE HOUSING 6-15CKT.		
	0.25 OVER 0.5 UNDER	± 0.05	CHECKED BY MYAGI	DATE 2004/07/30			
	0.5 OVER 1.0 UNDER	± 0.1	APPROVED BY NUKITA	DATE 2015/10/02			
1.0 OVER 30 UNDER	± 0.25	MATERIAL NO.		DOCUMENT NO.	SHEET NO.		
30 OVER	± 0.3	SEE TABLE		SD-501330-002	1 OF 2		
ANGULAR $\pm 3^\circ$		DRAFT WHERE APPLICABLE MUST REMAIN WITHIN DIMENSIONS		THIS DRAWING CONTAINS INFORMATION THAT IS PROPRIETARY TO MOLEX INCORPORATED AND SHOULD NOT BE USED WITHOUT WRITTEN PERMISSION			

9 8 7 6 5 4 3 2 1

紫 VIOLET	橙 ORANGE	茶 BROWN	緑 GREEN	青 BLUE	黄 YELLOW	赤 RED	黒 BLACK	色 COLOR	
501330-1539	501330-1538	501330-1537	501330-1536	501330-1534	501330-1533	501330-1532	501330-1531	15	501330-***3*
501330-1439	501330-1438	501330-1437	501330-1436	501330-1434	501330-1433	501330-1432	501330-1431	14	
501330-1339	501330-1338	501330-1337	501330-1336	501330-1334	501330-1333	501330-1332	501330-1331	13	
501330-1239	501330-1238	501330-1237	501330-1236	501330-1234	501330-1233	501330-1232	501330-1231	12	
501330-1139	501330-1138	501330-1137	501330-1136	501330-1134	501330-1133	501330-1132	501330-1131	11	
501330-1039	501330-1038	501330-1037	501330-1036	501330-1034	501330-1033	501330-1032	501330-1031	10	
501330-0939	501330-0938	501330-0937	501330-0936	501330-0934	501330-0933	501330-0932	501330-0931	9	
501330-0839	501330-0838	501330-0837	501330-0836	501330-0834	501330-0833	501330-0832	501330-0831	8	
501330-0739	501330-0738	501330-0737	501330-0736	501330-0734	501330-0733	501330-0732	501330-0731	7	
501330-0639	501330-0638	501330-0637	501330-0636	501330-0634	501330-0633	501330-0632	501330-0631	6	
MATERIAL NO.	MATERIAL NO.	MATERIAL NO.	MATERIAL NO.	MATERIAL NO.	MATERIAL NO.	MATERIAL NO.	MATERIAL NO.	CKT.	MODEL NO.

白 WHITE	色 COLOR	
501330-1500	15	501330-***00
501330-1400	14	
501330-1300	13	
501330-1200	12	
501330-1100	11	
501330-1000	10	
501330-0900	9	
501330-0800	8	
501330-0700	7	
501330-0600	6	
MATERIAL NO.	CKT.	MODEL NO.

REVISED EC NO: J2016-0342 DRINKMATSUYAMA 2015/10/02 CHKD:KASAKAWA 2015/10/02 APPR:NUKITA 2015/10/02	GENERAL TOLERANCES (UNLESS SPECIFIED)		DIMENSION STYLE MM ONLY		SCALE 10:1	DESIGN UNITS METRIC	THIRD ANGLE PROJECTION	
	0.25 UNDER	± 0.03	DRAWN BY	DATE	TITLE 1.0 WIRE TO BOARD CONN. 1-ROW RECEPTACLE HOUSING 6-15CKT.			
	0.25 OVER 0.5 UNDER	± 0.05	NYOSHIDA	2004/07/30				
	0.5 OVER 1.0 UNDER	± 0.1	CHECKED BY	DATE	DOCUMENT NO. molex SD-501330-002			
	1.0 OVER 10 UNDER	± 0.2	MYAGI	2004/07/30				
	10 OVER 30 UNDER	± 0.25	APPROVED BY	DATE	SHEET NO. 2 OF 2			
30 OVER	± 0.3	NUKITA	2015/10/02					
ANGULAR ±3 °		MATERIAL NO. SEE TABLE						
DRAFT WHERE APPLICABLE MUST REMAIN WITHIN DIMENSIONS				SIZE A3	THIS DRAWING CONTAINS INFORMATION THAT IS PROPRIETARY TO MOLEX INCORPORATED AND SHOULD NOT BE USED WITHOUT WRITTEN PERMISSION			