

THIS DOCUMENT IS THE PROPERTY OF KEYSTONE ELECTRONICS CORP. AND SHALL NOT BE REPRODUCED, DISTRIBUTED OR USED AS A BASIS FOR MANUFACTURE WITHOUT PRIOR WRITTEN PERMISSION FROM KEYSTONE ELECTRONICS CORP.

ACTUAL SIZE

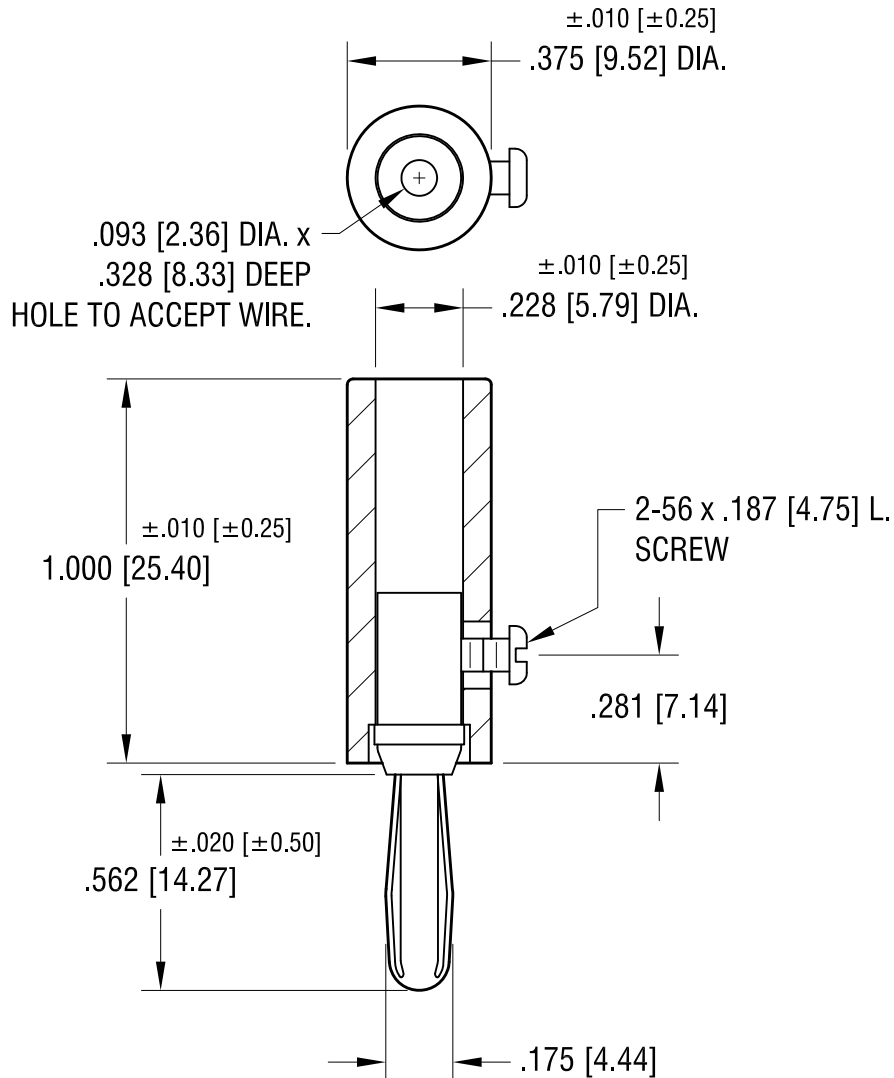

NOTES:

- 1. SPRING: MAT'L - NICKEL SILVER
- BODY: MAT'L - BRASS
- FINISH - NICKEL PLATE
- HANDLE: MAT'L - NYLON

PART NO.	COLOR
6084	RED
6085	BLACK

KEYSTONE ELECTRONICS CORP.			
www.keyelco.com • ASTORIA, N.Y. 11105-2017 • Tel (718) 956-8900			
PART NAME BANANA PLUG, SOLDERLESS CONNECTION			
MATERIAL AS NOTED			
FINISH AS NOTED		DRN BY BOONE	DATE 1.12.06
		APP'D LN	SCALE 2X
TOLERANCES	INCH [MM]	CODE	DWG NO.
DECIMAL	± .005 [± 0.13]	C	6084-6085
ANGULAR	± 1°		
UNLESS OTHERWISE SPECIFIED			

DATE	DESCRIPTION	REV.

Mouser Electronics

Authorized Distributor

Click to View Pricing, Inventory, Delivery & Lifecycle Information:

[Keystone Electronics:](#)

[6084](#)