

For board-to-board	<b>P5K/P5KS</b>
<b>Narrow pitch connectors (0.5mm pitch)</b>	

Mated heights of 3.0 to 9.0 mm supported with “TOUGH CONTACT” construction provides resistant to various environmental conditions.

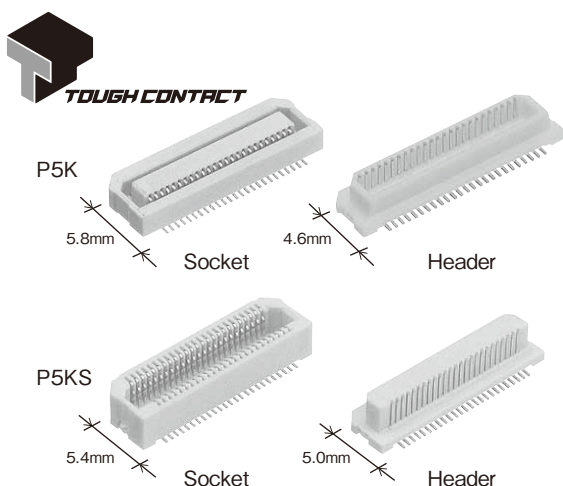

### FEATURES

1. Wide range of mated heights (3.0 to 9.0 mm) is available
2. “TOUGH CONTACT” construction provides high contact reliability design resistant to various environmental conditions.
3. The effective mating length is long and there is enough space for mating.

### APPLICATIONS

Mobile devices and industrial equipment

### DETAILED FEATURES

The effective mating length is long and there is enough space for mating.

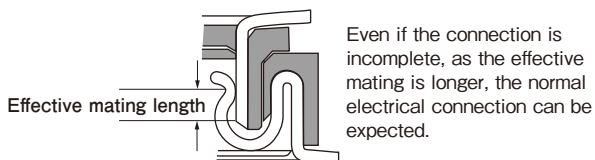

Type	Effective mating length
P5K	0.65 mm
P5KS	1.0 mm

### Automatic mounting

Suction area for automatic mounting machines is employed.

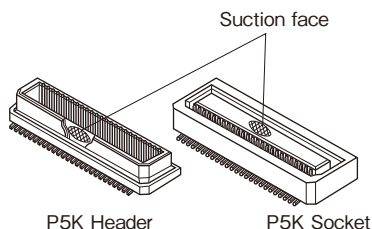

## ORDERING INFORMATION

### P5K (Mated height: 3.0 mm and 3.5 mm)

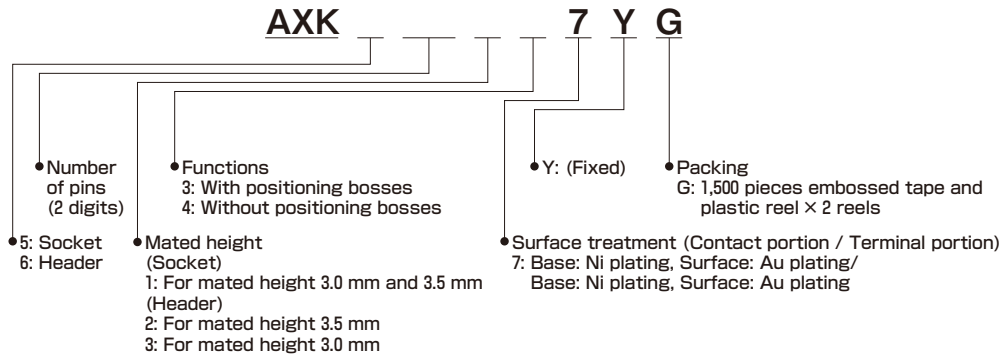

### P5KS (Mated height: 4.0 mm, 4.5 mm, 5.0 mm, 5.5 mm, 6.0 mm, 6.5 mm, 7.0 mm, 8.0 mm and 9.0 mm)

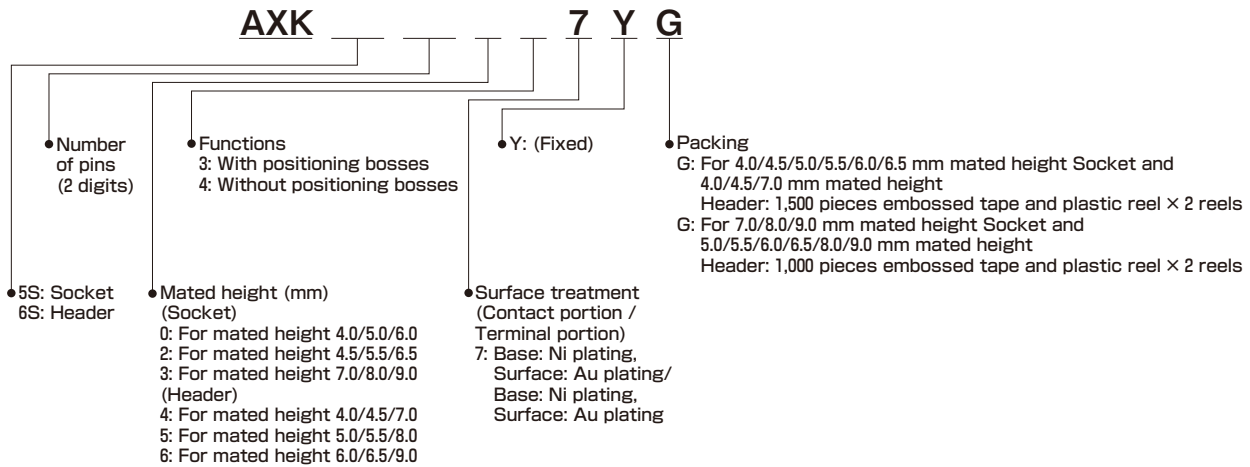

## PRODUCT TYPES

### P5K

Mated height	Number of pins	Part number		Packing	
		Socket	Header	Inner carton (1-reel)	Outer carton
3.0 mm	20	AXK520147YG	AXK620347YG	1,500 pieces	3,000 pieces
	22	AXK522147YG	AXK622347YG		
	30	AXK530147YG	AXK630347YG		
	40	AXK540147YG	AXK640347YG		
	50	AXK550147YG	AXK650347YG		
	60	AXK560147YG	AXK660347YG		
	70	AXK570147YG	AXK670347YG		
	80	AXK580147YG	AXK680347YG		
	100	AXK500147YG	AXK600347YG		
3.5 mm	120	AXK5A2147YG	AXK6A2347YG		
	20	AXK520147YG	AXK620247YG		
	22	AXK522147YG	AXK622247YG		
	30	AXK530147YG	AXK630247YG		
	34	AXK534147YG	AXK634247YG		
	40	AXK540147YG	AXK640247YG		
	50	AXK550147YG	AXK650247YG		
	60	AXK560147YG	AXK660247YG		
	70	AXK570147YG	AXK670247YG		
	80	AXK580147YG	AXK680247YG		
	100	AXK500147YG	AXK600247YG		
	120	AXK5A2147YG	AXK6A2247YG		

Notes: 1. Order unit: For volume production: 1-inner carton (1-reel) units. For samples, please contact our sales office.  
2. The standard type comes without positioning bosses. Connectors with positioning bosses are available for on-demand production.

## P5KS

Mated height	Number of pins	Part number		Packing	
		Socket	Header	Inner carton (1-reel)	Outer carton
4.0 mm	20	AXK5S20047YG	AXK6S20447YG	1,500 pieces	3,000 pieces
	24	AXK5S24047YG	AXK6S24447YG		
	30	AXK5S30047YG	AXK6S30447YG		
	34	AXK5S34047YG	AXK6S34447YG		
	40	AXK5S40047YG	AXK6S40447YG		
	50	AXK5S50047YG	AXK6S50447YG		
	60	AXK5S60047YG	AXK6S60447YG		
	70	AXK5S70047YG	AXK6S70447YG		
	80	AXK5S80047YG	AXK6S80447YG		
	100	AXK5S00047YG	AXK6S00447YG		
4.5 mm	20	AXK5S20247YG	AXK6S20447YG		
	24	AXK5S24247YG	AXK6S24447YG		
	30	AXK5S30247YG	AXK6S30447YG		
	34	AXK5S34247YG	AXK6S34447YG		
	40	AXK5S40247YG	AXK6S40447YG		
	50	AXK5S50247YG	AXK6S50447YG		
	60	AXK5S60247YG	AXK6S60447YG		
	70	AXK5S70247YG	AXK6S70447YG		
	80	AXK5S80247YG	AXK6S80447YG		
	100	AXK5S00247YG	AXK6S00447YG		
5.0 mm	20	AXK5S20047YG	AXK6S20547YG	Socket: 1,500 pieces Header: 1,000 pieces	Socket: 3,000 pieces Header: 2,000 pieces
	24	AXK5S24047YG	AXK6S24547YG		
	30	AXK5S30047YG	AXK6S30547YG		
	34	AXK5S34047YG	AXK6S34547YG		
	40	AXK5S40047YG	AXK6S40547YG		
	50	AXK5S50047YG	AXK6S50547YG		
	60	AXK5S60047YG	AXK6S60547YG		
	70	AXK5S70047YG	AXK6S70547YG		
	80	AXK5S80047YG	AXK6S80547YG		
	100	AXK5S00047YG	AXK6S00547YG		
5.5 mm	20	AXK5S20247YG	AXK6S20547YG		
	24	AXK5S24247YG	AXK6S24547YG		
	30	AXK5S30247YG	AXK6S30547YG		
	34	AXK5S34247YG	AXK6S34547YG		
	40	AXK5S40247YG	AXK6S40547YG		
	50	AXK5S50247YG	AXK6S50547YG		
	60	AXK5S60247YG	AXK6S60547YG		
	70	AXK5S70247YG	AXK6S70547YG		
	80	AXK5S80247YG	AXK6S80547YG		
	100	AXK5S00247YG	AXK6S00547YG		
6.0 mm	20	AXK5S20047YG	AXK6S20647YG		
	30	AXK5S30047YG	AXK6S30647YG		
	40	AXK5S40047YG	AXK6S40647YG		
	50	AXK5S50047YG	AXK6S50647YG		
	60	AXK5S60047YG	AXK6S60647YG		
	70	AXK5S70047YG	AXK6S70647YG		
	80	AXK5S80047YG	AXK6S80647YG		
100	AXK5S00047YG	AXK6S00647YG			

Notes: 1. Order unit: For volume production: 1-inner carton (1-reel) units. For samples, please contact our sales office.

2. The standard type comes without positioning bosses. Connectors with positioning bosses are available for on-demand production.

## Narrow pitch connectors P5K/P5KS (0.5mm pitch)

Mated height	Number of pins	Part number		Packing	
		Socket	Header	Inner carton (1-reel)	Outer carton
6.5 mm	20	AXK5S20247YG	AXK6S20647YG	Socket: 1,500 pieces Header: 1,000 pieces	Socket: 3,000 pieces Header: 2,000 pieces
	30	AXK5S30247YG	AXK6S30647YG		
	40	AXK5S40247YG	AXK6S40647YG		
	50	AXK5S50247YG	AXK6S50647YG		
	60	AXK5S60247YG	AXK6S60647YG		
	70	AXK5S70247YG	AXK6S70647YG		
	100	AXK5S00247YG	AXK6S00647YG		
7.0 mm	20	AXK5S20347YG	AXK6S20447YG	Socket: 1,000 pieces Header: 1,500 pieces	Socket: 2,000 pieces Header: 3,000 pieces
	30	AXK5S30347YG	AXK6S30447YG		
	40	AXK5S40347YG	AXK6S40447YG		
	50	AXK5S50347YG	AXK6S50447YG		
	60	AXK5S60347YG	AXK6S60447YG		
	70	AXK5S70347YG	AXK6S70447YG		
	100	AXK5S00347YG	AXK6S00447YG		
8.0 mm	20	AXK5S20347YG	AXK6S20547YG	1,000 pieces	2,000 pieces
	30	AXK5S30347YG	AXK6S30547YG		
	40	AXK5S40347YG	AXK6S40547YG		
	50	AXK5S50347YG	AXK6S50547YG		
	60	AXK5S60347YG	AXK6S60547YG		
	70	AXK5S70347YG	AXK6S70547YG		
	100	AXK5S00347YG	AXK6S00547YG		
9.0 mm	20	AXK5S20347YG	AXK6S20647YG	1,000 pieces	2,000 pieces
	30	AXK5S30347YG	AXK6S30647YG		
	40	AXK5S40347YG	AXK6S40647YG		
	50	AXK5S50347YG	AXK6S50647YG		
	60	AXK5S60347YG	AXK6S60647YG		
	70	AXK5S70347YG	AXK6S70647YG		
	100	AXK5S00347YG	AXK6S00647YG		

Notes: 1. Order unit: For volume production: 1-inner carton (1-reel) units. For samples, please contact our sales office.  
 2. The standard type comes without positioning bosses. Connectors with positioning bosses are available for on-demand production.

# SPECIFICATIONS

## 1. Characteristics

Item		Specifications			Conditions																		
		(Mated height) 3.0 mm, 3.5 mm	(Mated height) 4.0 mm, 4.5 mm, 5.0 mm, 5.5 mm; 6.0 mm, 6.5 mm	(Mated height) 7.0 mm, 8.0 mm, 9.0 mm																			
Electrical characteristics	Rated current	0.5A/pin contact (Max. 10A at total pin contacts)	0.5A/pin contact (Max. 16A at total pin contacts)																				
	Rated voltage	60V AC/DC																					
	Dielectric strength	150V AC for 1 min.			No short-circuiting or damage at a detection current of 1 mA when the specified voltage is applied for one minute.																		
	Insulation resistance	Min. 1000M $\Omega$			Using 500V DC megger (applied for 1 min.)																		
	Contact resistance	Max. 60m $\Omega$	Max. 80m $\Omega$		Based on the contact resistance measurement method specified by JIS C 5402.																		
Mechanical characteristics	Composite insertion force	Max. 0.785N/pin contact $\times$ pin contacts (initial)																					
	Composite removal force	Min. 0.0588N/pin contact $\times$ pin contacts																					
Environmental characteristics	Ambient temperature	-55 to +85°C			No icing. No condensation.																		
	Soldering heat resistance	The initial specification must be satisfied electrically and mechanically.			Reflow soldering: Peak temperature: 260°C or less (on the surface of the PC board around the connector terminals) Soldering iron: 300°C within 5 sec. 350°C within 3 sec.																		
	Storage temperature	-55 to +85°C (product only) -40 to +50°C (emboss packing)			No icing. No condensation.																		
	Thermal shock resistance (header and socket mated)	5 cycles, insulation resistance min. 100M $\Omega$ , contact resistance max. 60m $\Omega$	5 cycles, insulation resistance min. 100M $\Omega$ , contact resistance max. 80m $\Omega$		Conformed to MIL-STD-202F, method 107G <table border="1"> <thead> <tr> <th>Order</th> <th>Temperature (°C)</th> <th>Time (minutes)</th> </tr> </thead> <tbody> <tr> <td>1</td> <td>-55<math>\frac{0}{3}</math></td> <td>30</td> </tr> <tr> <td>2</td> <td>}</td> <td>Max. 5</td> </tr> <tr> <td>3</td> <td>85<math>\frac{-3}{0}</math></td> <td>30</td> </tr> <tr> <td>4</td> <td>}</td> <td>Max. 5</td> </tr> <tr> <td></td> <td>-55<math>\frac{0}{3}</math></td> <td></td> </tr> </tbody> </table>	Order	Temperature (°C)	Time (minutes)	1	-55 $\frac{0}{3}$	30	2	}	Max. 5	3	85 $\frac{-3}{0}$	30	4	}	Max. 5		-55 $\frac{0}{3}$	
	Order	Temperature (°C)	Time (minutes)																				
	1	-55 $\frac{0}{3}$	30																				
	2	}	Max. 5																				
3	85 $\frac{-3}{0}$	30																					
4	}	Max. 5																					
	-55 $\frac{0}{3}$																						
Humidity resistance (header and socket mated)	120 hours, insulation resistance min. 100M $\Omega$ , contact resistance max. 60m $\Omega$	120 hours, insulation resistance min. 100M $\Omega$ , contact resistance max. 80m $\Omega$		Conformed to IEC60068-2-78 Temperature 40 $\pm$ 2°C, humidity 90 to 95% R.H.																			
Saltwater spray resistance (header and socket mated)	24 hours, insulation resistance min. 100M $\Omega$ , contact resistance max. 60m $\Omega$	24 hours, insulation resistance min. 100M $\Omega$ , contact resistance max. 80m $\Omega$		Conformed to IEC60068-2-11 Temperature 35 $\pm$ 2°C, saltwater concentration 5 $\pm$ 1%																			
H <sub>2</sub> S resistance (header and socket mated)	48 hours, contact resistance max. 60m $\Omega$	48 hours, contact resistance max. 80m $\Omega$		Temperature 40 $\pm$ 2°C, gas concentration 3 $\pm$ 1 ppm, humidity 75 to 80% R.H.																			
Lifetime characteristics	Insertion and removal life	50 times			Repeated insertion and removal speed of max. 200 times/hours																		
Unit weight	P5K Mated height 3.0 mm 30 pins: Socket 0.17 g, Header: 0.09 g P5KS Mated height 4.0 mm 30 pins: Socket 0.18 g, Header: 0.16 g																						

## 2. Material and surface treatment

Part name	Material	Surface treatment
Molded portion	LCP resin (UL94V-0)	—
Contact and Post	Copper alloy	Contact portion: Base: Ni plating Surface: Au plating Terminal portion: Base: Ni plating Surface: Au plating (except the terminal tips) The terminals close to the portion to be soldered have nickel barriers (exposed nickel portions).

# Narrow pitch connectors P5K/P5KS (0.5mm pitch)

## DIMENSIONS (Unit: mm)

The CAD data of the products with a **CAD** mark can be downloaded from: <http://industrial.panasonic.com/ac/e/>

### P5K Socket (Mated height 3.0 mm and 3.5 mm)

**CAD**

#### External dimensions

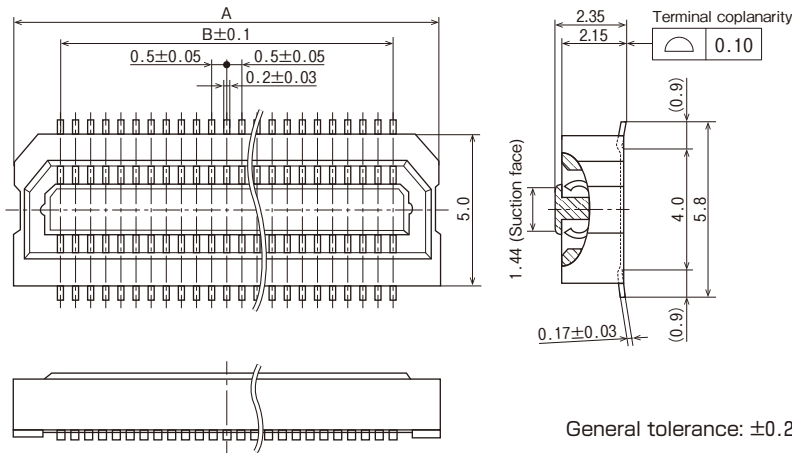

#### Dimension table

Dimensions	A	B
Number of pins		
20	8.20	4.50
22	8.70	5.00
30	10.70	7.00
34	11.70	8.00
40	13.20	9.50
50	15.70	12.00
60	18.20	14.50
70	20.70	17.00
80	23.20	19.50
100	28.20	24.50
120	33.20	29.50

General tolerance: ±0.2

### P5K Header (Mated height 3.0 mm and 3.5 mm)

**CAD**

#### External dimensions

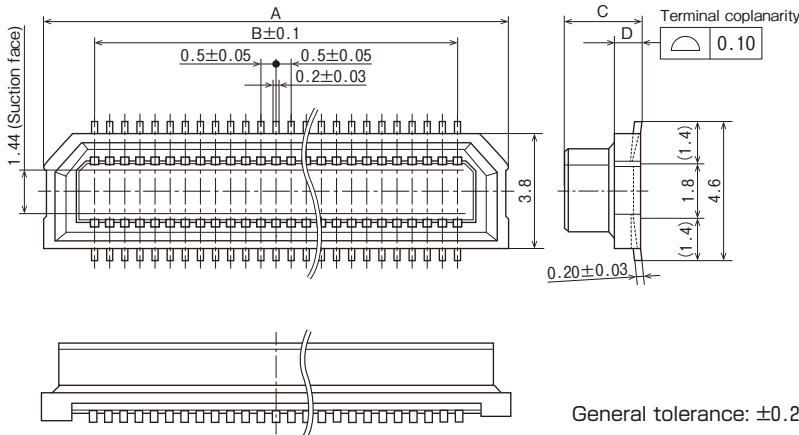

#### Dimension table

Dimensions	A	B
Number of pins		
20	8.20	4.50
22	8.70	5.00
30	10.70	7.00
34	11.70	8.00
40	13.20	9.50
50	15.70	12.00
60	18.20	14.50
70	20.70	17.00
80	23.20	19.50
100	28.20	24.50
120	33.20	29.50

General tolerance: ±0.2

Dimensions	C	D
Mated height		
3.0 mm	2.40	0.85
3.5 mm	2.90	1.35

### Socket and header are mated

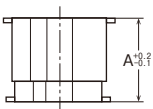

Dimensions	A
Mated height	
3.0 mm	3.0
3.5 mm	3.5

Note: P5KS (mated heights 4.0mm, 4.5mm, 5.0mm, 5.5mm, 6.0mm, 6.5mm, 7.0mm, 8.0mm, and 9.0mm) cannot be mated to this type.

**P5KS Socket (Mated height 4.0 mm, 4.5 mm, 5.0 mm, 5.5 mm, 6.0 mm, 6.5 mm, 7.0 mm, 8.0 mm and 9.0 mm)**

**CAD**

External dimensions

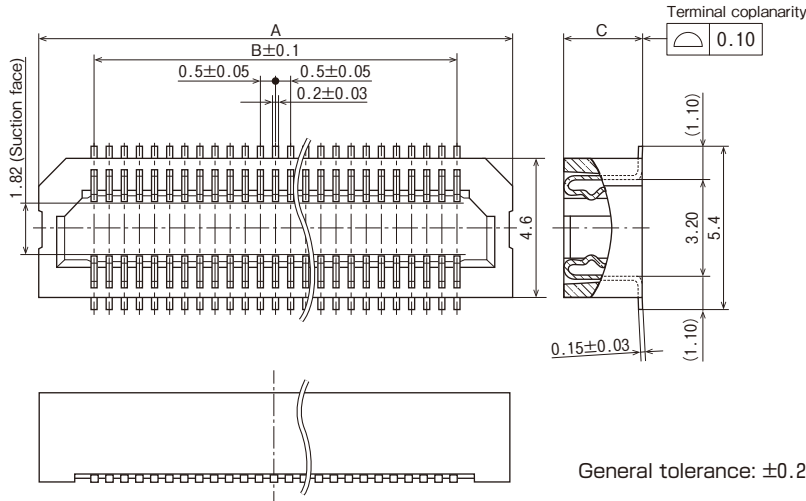

Dimension table

Number of pins	Dimensions	
	A	B
20	8.20	4.50
24	9.20	5.50
30	10.70	7.00
34	11.70	8.00
40	13.20	9.50
50	15.70	12.00
60	18.20	14.50
70	20.70	17.00
80	23.20	19.50
100	28.20	24.50

Mated height	Dimensions	C
	4.0 mm, 5.0 mm, 6.0 mm	
4.5 mm, 5.5 mm, 6.5 mm		3.55
7.0 mm, 8.0 mm, 9.0 mm		6.05

**P5KS Header (Mated height 4.0 mm, 4.5 mm, 5.0 mm, 5.5 mm, 6.0 mm, 6.5 mm, 7.0 mm, 8.0 mm and 9.0mm)**

**CAD**

External dimensions

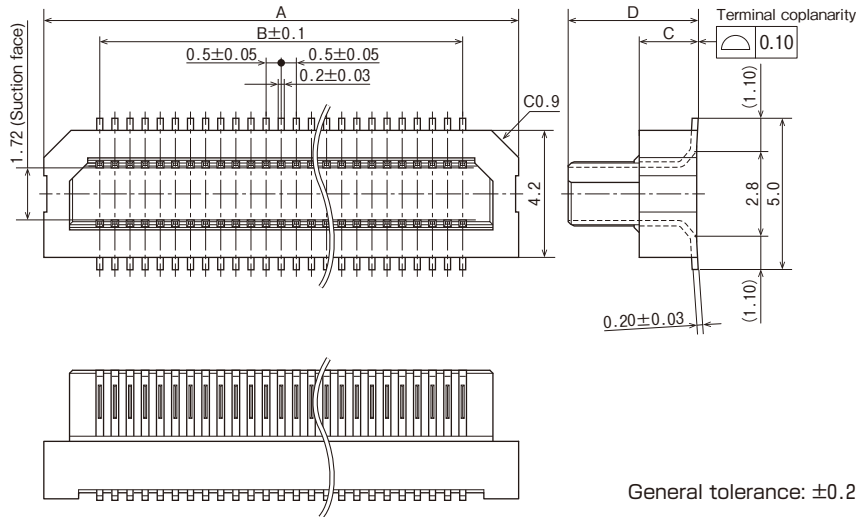

Dimension table

Number of pins	Dimensions	
	A	B
20	8.20	4.50
24	9.20	5.50
30	10.70	7.00
34	11.70	8.00
40	13.20	9.50
50	15.70	12.00
60	18.20	14.50
70	20.70	17.00
80	23.20	19.50
100	28.20	24.50

Mated height	Dimensions	C	D
	4.0 mm, 4.5 mm, 7.0 mm		0.95
5.0 mm, 5.5 mm, 8.0 mm		1.95	4.30
6.0 mm, 6.5 mm, 9.0 mm		2.95	5.30

**Socket and header are mated**



Mated height	Dimensions	A
	4.0 mm	
4.5 mm		4.50
5.0 mm		5.00
5.5 mm		5.50
6.0 mm		6.00
6.5 mm		6.50
7.0 mm		7.00
8.0 mm		8.00
9.0 mm		9.00

Note: P5K (mated heights 3.0mm, 3.5mm) cannot be mated to this type.

## EMBOSSED TAPE DIMENSIONS (unit: mm)

### Specifications for taping

In accordance with JIS C 0806-3:1999. However, not applied to the mounting-hole pitch of some connectors.

### Specifications for the plastic reel

In accordance with EIAJ ET-7200B.

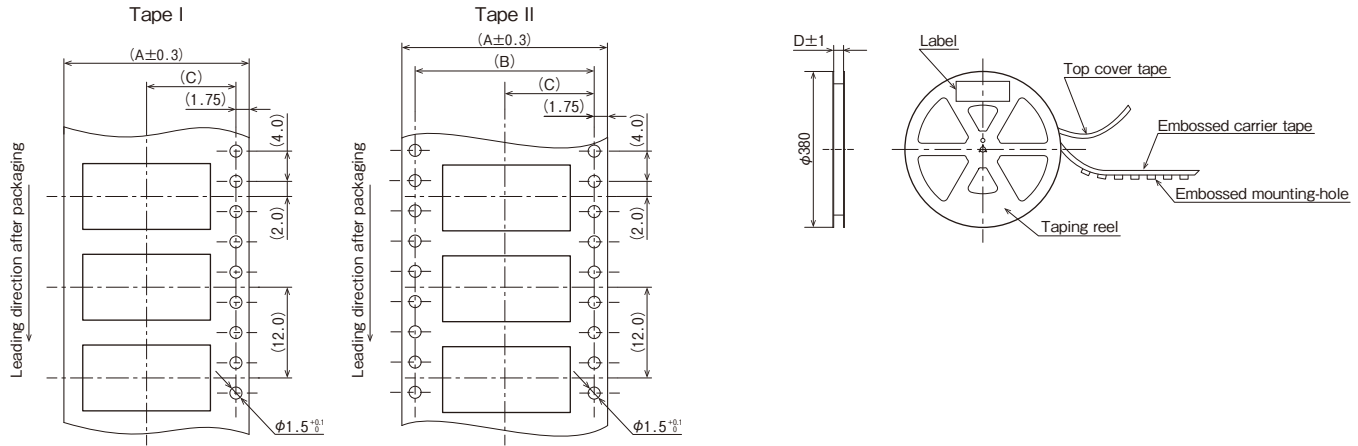

### Dimension table

#### P5K

Type/Mated height	No. of pins	Type of taping	A	B	C	D	Quantity per reel
Socket and header are common 3.0mm, 3.5mm	20 to 50	Tape I	24.0	—	11.5	25.4	1,500 pcs.
	60 to 70	Tape II	32.0	28.4	14.2	33.4	
	80 to 100	Tape II	44.0	40.4	20.2	45.4	
	120	Tape II	56.0	52.4	26.2	57.4	

#### P5KS

Type/Mated height	No. of pins	Type of taping	A	B	C	D	Quantity per reel
Socket 4.0mm, 4.5mm, 5.0mm, 5.5mm, 6.0mm, 6.5mm Header 4.0mm, 4.5mm, 7.0mm	20 to 50	Tape I	24.0	—	11.5	25.4	1,500 pcs.
	60 to 70	Tape II	32.0	28.4	14.2	33.4	
	80 to 100	Tape II	44.0	40.4	20.2	45.4	
Socket 7.0mm, 8.0mm, 9.0mm Header 5.0mm, 5.5mm, 6.0mm, 6.5mm, 8.0mm, 9.0mm	20 to 50	Tape I	24.0	—	11.5	25.4	1,000 pcs.
	60 to 70	Tape II	32.0	28.4	14.2	33.4	
	80 to 100	Tape II	44.0	40.4	20.2	45.4	

### Connector orientation with respect to embossed tape feeding direction

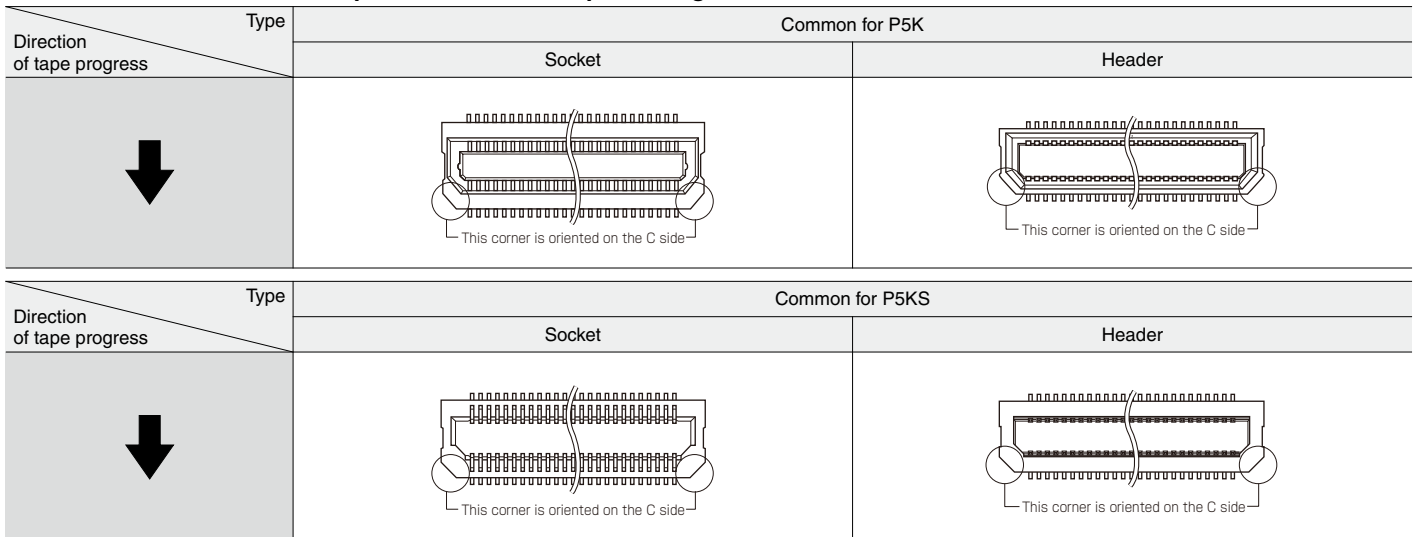



**NOTES** (Unit: mm)

**Prevention of reverse mating**

The socket and header are protected from reverse mating by a molded resin key. Excessive mating force may damage the key, so be sure to match chamfered corners when mating.

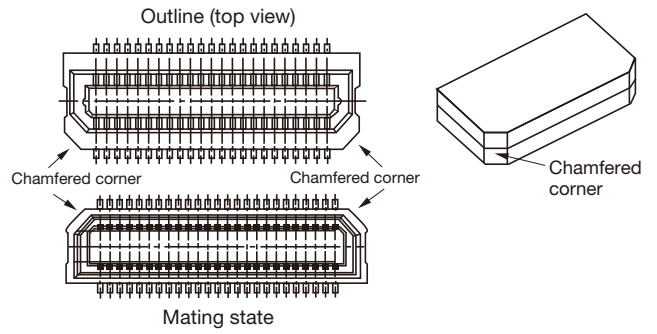

**Design of PC board patterns**

Conduct the recommended foot pattern design, in order to preserve the mechanical strength of terminal solder areas.

**Recommended PC board and metal mask patterns**

Connectors are mounted with high pitch density, intervals of 0.35 mm, 0.4 mm or 0.5 mm. In order to reduce solder and flux rise, solder bridges and other issues make sure the proper levels of solder is used.

The figures are recommended patterns. Please use them as a reference.

**P5K Socket**

Recommended PC board pattern (TOP VIEW)

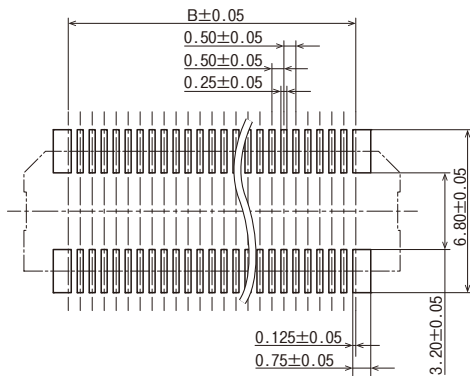

**P5K Header**

Recommended PC board pattern (TOP VIEW)

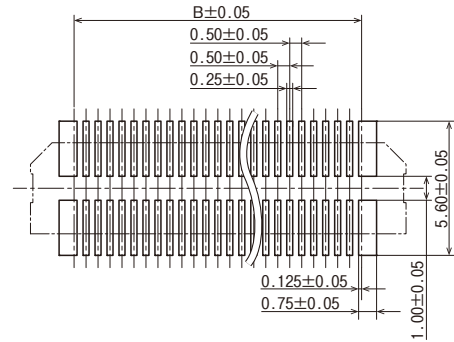

Recommended metal mask pattern  
Metal mask thickness: When 150µm  
(Opening area ratio: 56%)

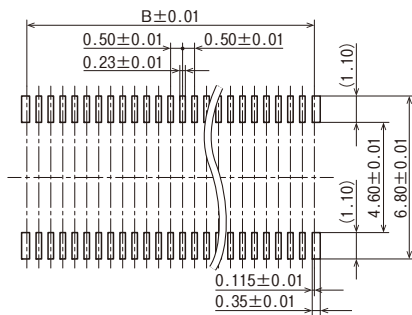

Recommended metal mask pattern  
Metal mask thickness: When 150µm  
(Opening area ratio: 62%)

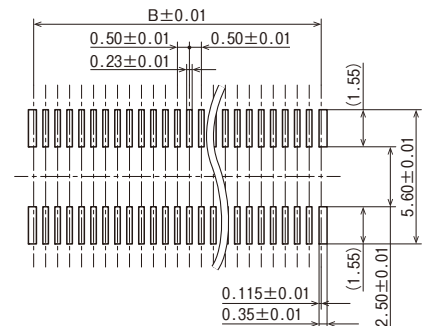

Recommended metal mask pattern  
Metal mask thickness: When 120µm  
(Opening area ratio: 69%)

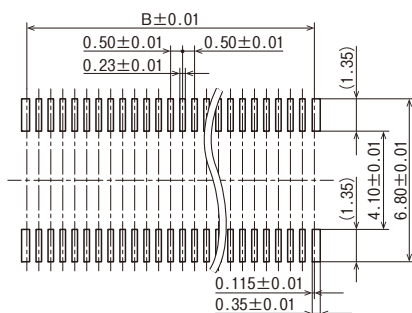

Recommended metal mask pattern  
Metal mask thickness: When 120µm  
(Opening area ratio: 78%)

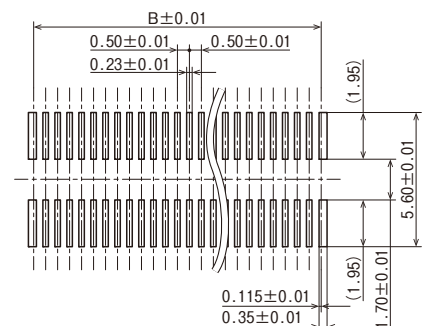

**P5KS Socket**

Recommended PC board pattern  
(TOP VIEW)

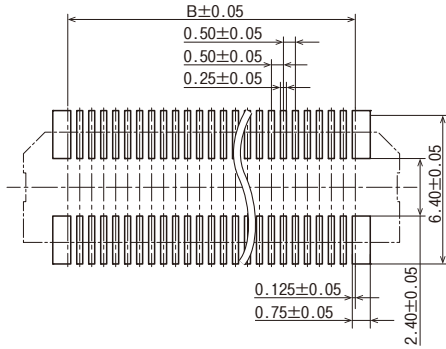

Recommended metal mask pattern  
Metal mask thickness: When 150µm  
(Opening area ratio: 60%)

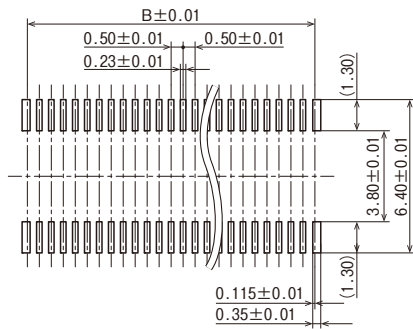

Recommended metal mask pattern  
Metal mask thickness: When 120µm  
(Opening area ratio: 76%)

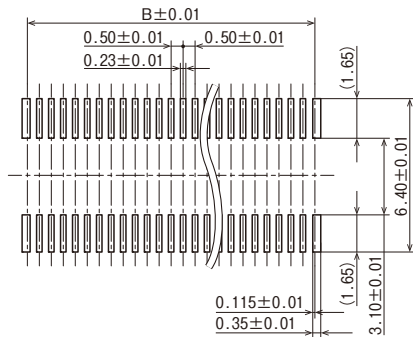

**P5KS Header**

Recommended PC board pattern  
(TOP VIEW)

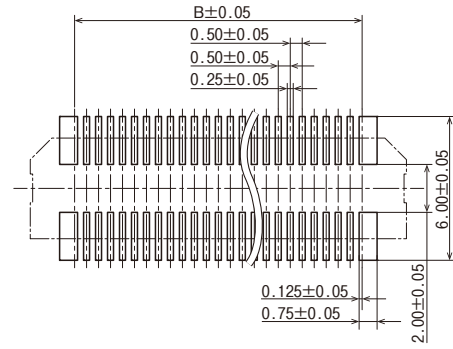

Recommended metal mask pattern  
Metal mask thickness: When 150µm  
(Opening area ratio: 69%)

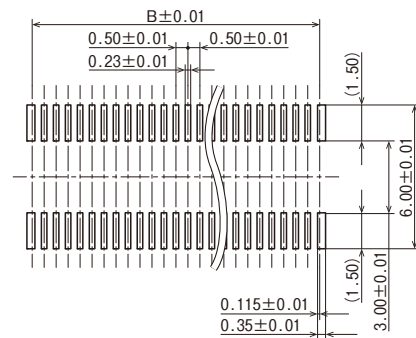

Recommended metal mask pattern  
Metal mask thickness: When 120µm  
(Opening area ratio: 87%)

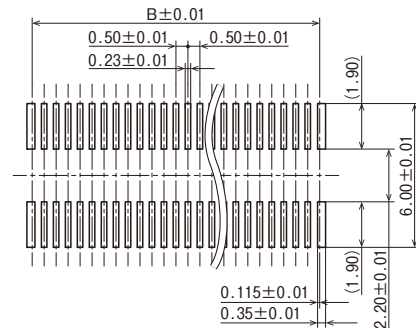

Please refer to the latest product specifications when designing your product.

# Notes on Using Narrow pitch Connectors/ High Current Connectors

## About safety remarks

Observe the following safety remarks to prevent accidents and injuries.

- 1) Do not use these connectors beyond the specification sheets. The usage outside of specified rated current, dielectric strength, and environmental conditions and so on may cause circuitry damage via abnormal heating, smoke, and fire.
- 2) In order to avoid accidents, your thorough specification review is appreciated. Please contact our sales office if your usage is out of the specifications. Otherwise, Panasonic Corporation cannot guarantee the quality and reliability.

- 3) Panasonic Corporation is consistently striving to improve quality and reliability. However, the fact remains that electrical components and devices generally cause failures at a given statistical probability. Furthermore, their durability varies with use environments or use conditions. In this respect, please check for actual electrical components and devices under actual conditions before use. Continued usage in a state of degraded condition may cause the deteriorated insulation, thus result in abnormal heat, smoke or firing. Please carry out safety design and periodic maintenance including redundancy design, design for fire spread prevention, and design for malfunction prevention so that no accidents resulting in injury or death, fire accidents, or social damage will be caused as a result of failure of the products or ending life of the products.

## Regarding the design of devices and PC board patterns

- 1) When using the board to board connectors, do not connect a pair of board with multiple connectors. Otherwise, misaligned connector positions may cause mating failure or product breakage.
- 2) With mounting equipment, there may be up to a  $\pm 0.2$  to 0.3 mm error in positioning. Be sure to design PC boards and patterns while taking into consideration the performance and abilities of the required equipment.
- 3) Some connectors have tabs embossed on the body to aid in positioning. When using these connectors, make sure that the PC board is designed with positioning holes to match these tabs.
- 4) To ensure the required mechanical strength when soldering the connector terminals, make sure the PC board meets recommended PC board pattern design dimensions given.
- 5) PC board  
Control the thicknesses of the cover lay and adhesive to prevent poor soldering. This connector has no stand-off. Therefore, minimize the thickness of the cover lay, etc. so as to prevent the occurrence of poor soldering.
- 6) For all connectors of the narrow pitch series, to prevent the PC board from coming off during vibrations or impacts, and to prevent loads from falling directly on the soldered portions, be sure to design some means to fix the PC board in place.  
Example) Secure in place with screws

- 7) When mounting connectors on a FPC
  - When the connector soldered to FPC is mated or unmated, solder detachment may occur by the force to the terminals. Connector handling is recommended in the condition when the reinforcing plate is attached to the backside of FPC where the connector is mounted. The external dimension of the reinforcing plate is recommended to be larger than the dimension of "Recommended PC board pattern" (extended dimension of one side is approximately 0.5 to 1.0 mm). The materials and thickness of the reinforcing plate are glass epoxy or polyimide (thickness 0.2 to 0.3 mm) or SUS (thickness 0.1 to 0.2 mm).
  - As this connector has temporary locking structure, the connector mating may be separated by the dropping impact depend on the size, weight or bending force of the FPC. Please consider the measures at usage to prevent the mating separation.
- 8) The narrow pitch connector series is designed to be compact and thin. Although ease of handling has been taken into account, take care when mating the connectors, as displacement or angled mating could damage or deform the connector.

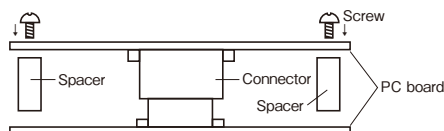

When connecting PC boards, take appropriate measures to prevent the connector from coming off.

## Regarding the selection of the connector placement machine and the mounting procedures

- 1) Select the placement machine taking into consideration the connector height, required positioning accuracy, and packaging conditions.
- 2) Be aware that if the chucking force of the placement machine is too great, it may deform the shape of the connector body or connector terminals.
- 3) Be aware that during mounting, external forces may be applied to the connector contact surfaces and terminals and cause deformations.
- 4) Depending on the size of the connector being used, self alignment may not be possible. In such cases, be sure to carefully position the terminal with the PC board pattern.

- 5) The positioning bosses give an approximate alignment for positioning on the PC board. For accurate positioning of the connector when mounting it to the PC board, we recommend using an automatic positioning machine.
- 6) In case of dry condition, please note the occurrence of static electricity. The product may be adhered to the embossed carrier tape or the cover tape in dry condition. Recommended humidity is from 40 to 60%RH and please remove static electricity by ionizer in manufacturing process.

## Regarding soldering

### Reflow soldering

- 1) Measure the recommended profile temperature for reflow soldering by placing a sensor on the PC board near the connector surface or terminals. (Please refer to the specification for detail because the temperature setting differs by products.)
- 2) As for cream solder printing, screen printing is recommended.
- 3) When setting the screen opening area and PC board foot pattern area, refer the recommended PC board pattern and window size of metal mask on the specification sheet, and make sure that the size of board pattern and metal mask at the base of the terminals are not increased.
- 4) Please pay attentions not to provide too much solder. It makes miss mating because of interference at soldering portion when mating.

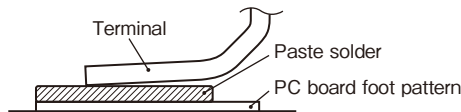

- 5) When mounting on both sides of the PC board and the connector is mounting on the underside, use adhesives or other means to ensure the connector is properly fixed to the PC board. (Double reflow soldering on the same side is possible.)
- 6) The condition of solder or flux rise and wettability varies depending on the type of solder and flux. Solder and flux characteristics should be taken into consideration and also set the reflow temperature and oxygen level.

- 7) Do not use resin-containing solder. Otherwise, the contacts might be firmly fixed.
- 8) Soldering conditions  
Please use the reflow temperature profile conditions recommended below for reflow soldering. Please contact our sales office before using a temperature profile other than that described below (e.g. lead-free solder)

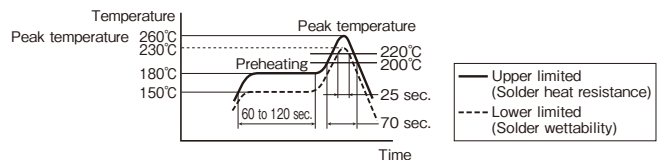

For products other than the ones above, please refer to the latest product specifications.

- 9) The temperature profiles given in this catalog are values measured when using the connector on a resin-based PC board. When performed reflow soldering on a metal board (iron, aluminum, etc.) or a metal table to mount on a FPC, make sure there is no deformation or discoloration of the connector before mounting.
- 10) Please contact our sales office when using a screen-printing thickness other than that recommended.

### Hand soldering

- 1) Set the soldering iron so that the tip temperature is less than that given in the table below.

Table A

Product name	Soldering iron temperature
SMD type connectors all products	300°C within 5 sec. 350°C within 3 sec.

- 2) Do not allow flux to spread onto the connector leads or PC board. This may lead to flux rising up to the connector inside.
- 3) Touch the soldering iron to the foot pattern. After the foot pattern and connector terminal are heated, apply the solder wire so it melts at the end of the connector terminals.

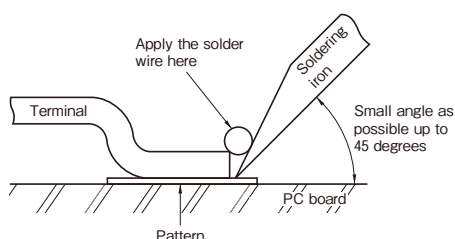

- 4) Be aware that soldering while applying a load on the connector terminals may cause improper operation of the connector.
- 5) Thoroughly clean the soldering iron.
- 6) Flux from the solder wire may get on the contact surfaces during soldering operations. After soldering, carefully check the contact surfaces and clean off any solder before use.
- 7) These connector is low profile type. If too much solder is supplied for hand soldering, It makes miss mating because of interference at soldering portion. Please pay attentions.

## Solder reworking

- 1) Finish reworking in one operation.
- 2) In case of soldering rework of bridges. Do not use supplementary solder flux. Doing so may cause contact problems by flux.
- 3) Keep the soldering iron tip temperature below the temperature given in Table A.

## Handling single components

- 1) Make sure not to drop or allow parts to fall from work bench.
- 2) Excessive force applied to the terminals could cause warping, come out, or weaken the adhesive strength of the solder. Handle with care.
- 3) Do not insert or remove the connector when it is not soldered. Forcibly applied external pressure on the terminals can weaken the adherence of the terminals to the molded part or cause the terminals to lose their evenness.

## Precautions for mating

This product is designed with ease of handling. However, in order to prevent the deformation or damage of contacts and molding, take care and do not mate the connectors as shown right.

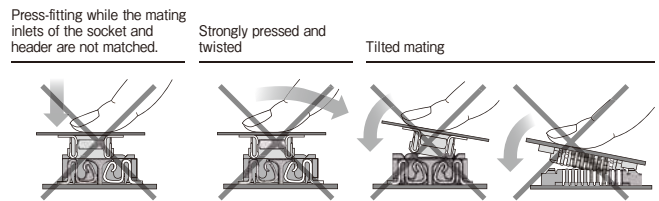

## Cleaning flux from PC board

There is no need to clean this product.  
If cleaning it, pay attention to the following points to prevent the negative effect to the product.

- 1) Keep the cleaning solvent clean and prevent the connector contacts from contamination.
- 2) Some cleaning solvents are strong and they may dissolve the molded part and characters, so pure water passed liquid solvent is recommended.

## Handling the PC board

### Handling the PC board after mounting the connector

When cutting or bending the PC board after mounting the connector, be careful that the soldered sections are subjected to excessive force.

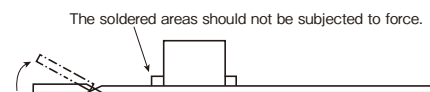

## Storage of connectors

- 1) To prevent problems from voids or air pockets due to heat of reflow soldering, avoid storing the connectors in areas of high humidity.
- 2) Depending on the connector type, the color of the connector may vary from connector to connector depending on when it is produced. Some connectors may change color slightly if subjected to ultraviolet rays during storage. This is normal and will not affect the operation of the connector.
- 3) When storing the connectors with the PC boards assembled and components already set, be careful not to stack them up so the connectors are subjected to excessive forces.
- 4) Avoid storing the connectors in locations with excessive dust. The dust may accumulate and cause improper connections at the contact surfaces.

## Other Notes

- 1) Do not remove or insert the electrified connector (in the state of carrying current or applying voltage).
- 2) Dropping of the products or rough mishandling may bend or damage the terminals and possibly hinder proper reflow soldering.
- 3) Before soldering, try not to insert or remove the connector more than absolutely necessary.
- 4) When coating the PC board after soldering the connector to prevent the deterioration of insulation, perform the coating in such a way so that the coating does not get on the connector.
- 5) There may be variations in the colors of products from different production lots. This is normal.
- 6) The connectors are not meant to be used for switching.
- 7) Product failures due to condensation are not covered by warranty.

## Regarding sample orders to confirm proper mounting

When ordering samples to confirm proper mounting with the placement machine, connectors are delivered in 50-piece units in the condition given right. Consult a sale representative for ordering sample units.

Condition when delivered from manufacturing



Embossed tape amount required for the mounting

Required number of products for sample production (Unit 50 pcs.)

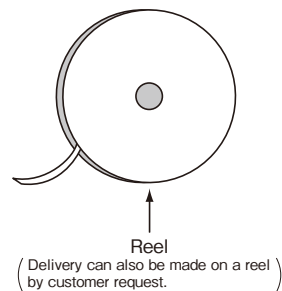

Please refer to the latest product specifications when designing your product.

---

Please contact .....

**Panasonic Corporation**

Electromechanical Control Business Division

■ 1006, Oaza Kadoma, Kadoma-shi, Osaka 571-8506, Japan  
[industrial.panasonic.com/ac/e/](http://industrial.panasonic.com/ac/e/)

**Panasonic**<sup>®</sup>

©Panasonic Corporation 2018

# Mouser Electronics

Authorized Distributor

Click to View Pricing, Inventory, Delivery & Lifecycle Information:

[Panasonic:](#)

[AXK500147BN1](#)