



Is Now Part of



**ON Semiconductor®**

To learn more about ON Semiconductor, please visit our website at  
[www.onsemi.com](http://www.onsemi.com)

Please note: As part of the Fairchild Semiconductor integration, some of the Fairchild orderable part numbers will need to change in order to meet ON Semiconductor's system requirements. Since the ON Semiconductor product management systems do not have the ability to manage part nomenclature that utilizes an underscore (\_), the underscore (\_) in the Fairchild part numbers will be changed to a dash (-). This document may contain device numbers with an underscore (\_). Please check the ON Semiconductor website to verify the updated device numbers. The most current and up-to-date ordering information can be found at [www.onsemi.com](http://www.onsemi.com). Please email any questions regarding the system integration to [Fairchild\\_questions@onsemi.com](mailto:Fairchild_questions@onsemi.com).

ON Semiconductor and the ON Semiconductor logo are trademarks of Semiconductor Components Industries, LLC dba ON Semiconductor or its subsidiaries in the United States and/or other countries. ON Semiconductor owns the rights to a number of patents, trademarks, copyrights, trade secrets, and other intellectual property. A listing of ON Semiconductor's product/patent coverage may be accessed at [www.onsemi.com/site/pdf/Patent-Marking.pdf](http://www.onsemi.com/site/pdf/Patent-Marking.pdf). ON Semiconductor reserves the right to make changes without further notice to any products herein. ON Semiconductor makes no warranty, representation or guarantee regarding the suitability of its products for any particular purpose, nor does ON Semiconductor assume any liability arising out of the application or use of any product or circuit, and specifically disclaims any and all liability, including without limitation special, consequential or incidental damages. Buyer is responsible for its products and applications using ON Semiconductor products, including compliance with all laws, regulations and safety requirements or standards, regardless of any support or applications information provided by ON Semiconductor. "Typical" parameters which may be provided in ON Semiconductor data sheets and/or specifications can and do vary in different applications and actual performance may vary over time. All operating parameters, including "Typicals" must be validated for each customer application by customer's technical experts. ON Semiconductor does not convey any license under its patent rights nor the rights of others. ON Semiconductor products are not designed, intended, or authorized for use as a critical component in life support systems or any FDA Class 3 medical devices or medical devices with a same or similar classification in a foreign jurisdiction or any devices intended for implantation in the human body. Should Buyer purchase or use ON Semiconductor products for any such unintended or unauthorized application, Buyer shall indemnify and hold ON Semiconductor and its officers, employees, subsidiaries, affiliates, and distributors harmless against all claims, costs, damages, and expenses, and reasonable attorney fees arising out of, directly or indirectly, any claim of personal injury or death associated with such unintended or unauthorized use, even if such claim alleges that ON Semiconductor was negligent regarding the design or manufacture of the part. ON Semiconductor is an Equal Opportunity/Affirmative Action Employer. This literature is subject to all applicable copyright laws and is not for resale in any manner.

# LM79XX

## 3-Terminal 1A Negative Voltage Regulator

### Features

- Output Current in Excess of 1A
- Output Voltages of -5, -6, -8, -9, -10, -12, -15, -18 and -24V
- Internal Thermal Overload Protection
- Short Circuit Protection
- Output Transistor Safe Operating Area Compensation

### Description

The LM79XX series of three terminal negative regulators are available in TO-220 package and with several fixed output voltages, making them useful in a wide range of applications. Each type employs internal current limiting, thermal shut down and safe operating area protection, making it essentially indestructible.

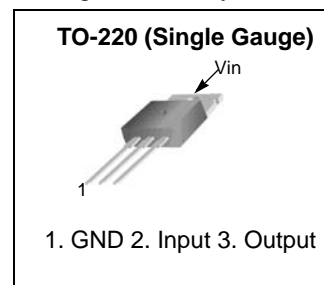

### Internal Block Diagram

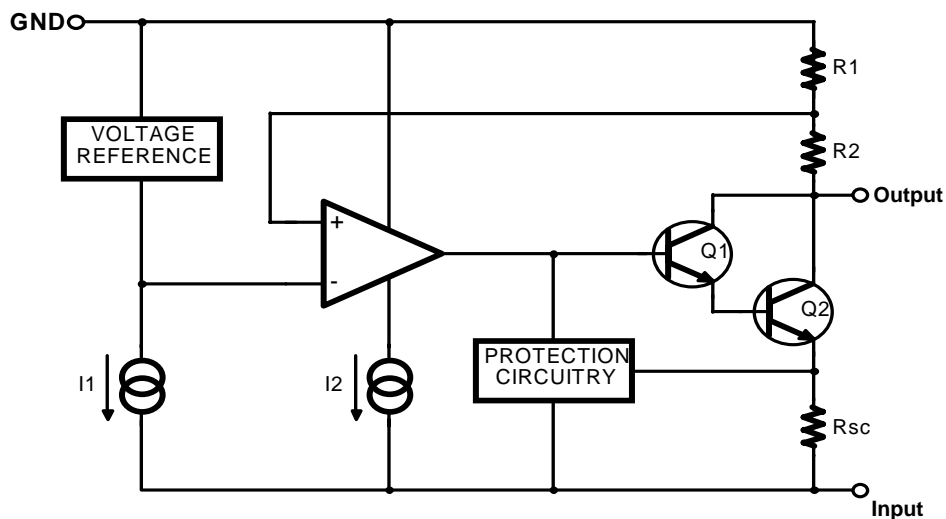

## Absolute Maximum Ratings

Parameter	Symbol	Value	Unit
Input Voltage	$V_I$	-35	V
Thermal Resistance Junction-Case (Note1)	$R_{\theta JC}$	5	°C/W
Thermal Resistance Junction-Air (Note1, 2)	$R_{\theta JA}$	65	
Operating Temperature Range	$T_{OPR}$	0 ~ +125	°C
Storage Temperature Range	$T_{STG}$	-65 ~ +150	°C

### Note:

- Thermal resistance test board  
Size: 76.2mm \* 114.3mm \* 1.6mm(1S0P)  
JEDEC standard: JESD51-3, JESD51-7
- Assume no ambient airflow

## Electrical Characteristics (LM7905)

( $V_I = -10V$ ,  $I_O = 500mA$ ,  $0^\circ C \leq T_J \leq +125^\circ C$ ,  $C_I = 2.2\mu F$ ,  $C_O = 1\mu F$ , unless otherwise specified.)

Parameter	Symbol	Conditions	Min.	Typ.	Max.	Unit	
Output Voltage	$V_O$	$T_J = +25^\circ C$	-4.8	-5.0	-5.2	V	
		$I_O = 5mA$ to 1A, $P_O \leq 15W$ $V_I = -7V$ to -20V	-4.75	-5.0	-5.25		
Line Regulation (Note3)	$\Delta V_O$	$T_J = +25^\circ C$	$V_I = -7V$ to -25V	-	35	100	mV
			$V_I = -8V$ to -12V	-	8	50	
Load Regulation (Note3)	$\Delta V_O$	$T_J = +25^\circ C$ $I_O = 5mA$ to 1.5A	-	10	100	mV	
		$T_J = +25^\circ C$ $I_O = 250mA$ to 750mA	-	3	50		
Quiescent Current	$I_Q$	$T_J = +25^\circ C$	-	3	6	mA	
Quiescent Current Change	$\Delta I_Q$	$I_O = 5mA$ to 1A	-	0.05	0.5	mA	
		$V_I = -8V$ to -25V	-	0.1	0.8		
Temperature Coefficient of $V_D$	$\Delta V_O / \Delta T$	$I_O = 5mA$	-	-0.4	-	mV/°C	
Output Noise Voltage	$V_N$	$f = 10Hz$ to 100kHz $T_A = +25^\circ C$	-	40	-	$\mu V$	
Ripple Rejection	RR	$f = 120Hz$ $\Delta V_I = 10V$	54	60	-	dB	
Dropout Voltage	$V_D$	$T_J = +25^\circ C$ $I_O = 1A$	-	2	-	V	
Short Circuit Current	$I_{SC}$	$T_J = +25^\circ C$ , $V_I = -35V$	-	300	-	mA	
Peak Current	$I_{PK}$	$T_J = +25^\circ C$	-	2.2	-	A	

### Note

- Load and line regulation are specified at constant junction temperature. Changes in  $V_O$  due to heating effects must be taken into account separately. Pulse testing with low duty is used.

**Electrical Characteristics (LM7906)** (Continued)(V<sub>I</sub> = -11V, I<sub>O</sub> = 500mA, 0°C ≤ T<sub>J</sub> ≤ +125°C, C<sub>I</sub> = 2.2μF, C<sub>O</sub> = 1μF, unless otherwise specified.)

Parameter	Symbol	Conditions	Min.	Typ.	Max.	Unit	
Output Voltage	V <sub>O</sub>	T <sub>J</sub> = +25°C	-5.75	-6	-6.25	V	
		I <sub>O</sub> = 5mA to 1A, P <sub>O</sub> ≤ 15W V <sub>I</sub> = -9V to -21V	-5.7	-6	-6.3		
Line Regulation (Note1)	ΔV <sub>O</sub>	T <sub>J</sub> = +25°C	V <sub>I</sub> = -8V to -25V	-	10	120	mV
			V <sub>I</sub> = -9V to -13V	-	5	60	
Load Regulation (Note1)	ΔV <sub>O</sub>	T <sub>J</sub> = +25°C I <sub>O</sub> = 5mA to 1.5A	-	10	120	mV	
		T <sub>J</sub> = +25°C I <sub>O</sub> = 250mA to 750mA	-	3	60		
Quiescent Current	I <sub>Q</sub>	T <sub>J</sub> = +25°C	-	3	6	mA	
Quiescent Current Change	ΔI <sub>Q</sub>	I <sub>O</sub> = 5mA to 1A	-	0.05	0.5	mA	
		V <sub>I</sub> = -8V to -25V	-	0.1	1.3		
Temperature Coefficient of V <sub>D</sub>	ΔV <sub>O</sub> /ΔT	I <sub>O</sub> = 5mA	-	-0.5	-	mV/°C	
Output Noise Voltage	V <sub>N</sub>	f = 10Hz to 100kHz T <sub>A</sub> = +25°C	-	130	-	μV	
Ripple Rejection	RR	f = 120Hz ΔV <sub>I</sub> = 10V	54	60	-	dB	
Dropout Voltage	V <sub>D</sub>	T <sub>J</sub> = +25°C I <sub>O</sub> = 1A	-	2	-	V	
Short Circuit Current	I <sub>SC</sub>	T <sub>J</sub> = +25°C, V <sub>I</sub> = -35V	-	300	-	mA	
Peak Current	I <sub>PK</sub>	T <sub>J</sub> = +25°C	-	2.2	-	A	

**Note**

1. Load and line regulation are specified at constant junction temperature. Changes in V<sub>O</sub> due to heating effects must be taken into account separately. Pulse testing with low duty is used.

**Electrical Characteristics (LM7908)** (Continued)(V<sub>I</sub> = -14V, I<sub>O</sub> = 500mA, 0°C ≤ T<sub>J</sub> ≤ +125°C, C<sub>I</sub> = 2.2μF, C<sub>O</sub> = 1μF, unless otherwise specified.)

Parameter	Symbol	Conditions	Min.	Typ.	Max.	Unit	
Output Voltage	V <sub>O</sub>	T <sub>J</sub> = +25°C	-7.7	-8	-8.3	V	
		I <sub>O</sub> = 5mA to 1A, P <sub>O</sub> ≤ 15W V <sub>I</sub> = -10V to -23V	-7.6	-8	-8.4		
Line Regulation (Note1)	ΔV <sub>O</sub>	T <sub>J</sub> = +25°C	V <sub>I</sub> = -10.5V to -25V	-	10	160	mV
			V <sub>I</sub> = -11V to -17V	-	5	80	
Load Regulation (Note1)	ΔV <sub>O</sub>	T <sub>J</sub> = +25°C I <sub>O</sub> = 5mA to 1.5A	-	12	160	mV	
		T <sub>J</sub> = +25°C I <sub>O</sub> = 250mA to 750mA	-	4	80		
Quiescent Current	I <sub>Q</sub>	T <sub>J</sub> = +25°C	-	3	6	mA	
Quiescent Current Change	ΔI <sub>Q</sub>	I <sub>O</sub> = 5mA to 1A	-	0.05	0.5	mA	
		V <sub>I</sub> = -10.5V to -25V	-	0.1	1		
Temperature Coefficient of V <sub>D</sub>	ΔV <sub>O</sub> /ΔT	I <sub>O</sub> = 5mA	-	-0.6	-	mV/°C	
Output Noise Voltage	V <sub>N</sub>	f = 10Hz to 100kHz T <sub>A</sub> = +25°C	-	175	-	μV	
Ripple Rejection	RR	f = 120Hz ΔV <sub>I</sub> = 10V	54	60	-	dB	
Dropout Voltage	V <sub>D</sub>	T <sub>J</sub> = +25°C I <sub>O</sub> = 1A	-	2	-	V	
Short Circuit Current	I <sub>SC</sub>	T <sub>J</sub> = +25°C, V <sub>I</sub> = -35V	-	300	-	mA	
Peak Current	I <sub>PK</sub>	T <sub>J</sub> = +25°C	-	2.2	-	A	

**Note**

1. Load and line regulation are specified at constant junction temperature. Changes in V<sub>O</sub> due to heating effects must be taken into account separately. Pulse testing with low duty is used.

**Electrical Characteristics (LM7909)** (Continued)(V<sub>I</sub> = -15V, I<sub>O</sub> = 500mA, 0°C ≤ T<sub>J</sub> ≤ +125°C, C<sub>I</sub> = 2.2μF, C<sub>O</sub> = 1μF, unless otherwise specified.)

Parameter	Symbol	Conditions	Min.	Typ.	Max.	Unit	
Output Voltage	V <sub>O</sub>	T <sub>J</sub> = +25°C	-8.7	-9.0	-9.3	V	
		I <sub>O</sub> = 5mA to 1A, P <sub>O</sub> ≤ 15W V <sub>I</sub> = -1.5V to -23V	-8.6	-9.0	-9.4		
Line Regulation (Note1)	ΔV <sub>O</sub>	T <sub>J</sub> = +25°C	V <sub>I</sub> = -11.5V to -26V	-	10	180	mV
			V <sub>I</sub> = -12V to -18V	-	5	90	
Load Regulation (Note1)	ΔV <sub>O</sub>	T <sub>J</sub> = +25°C I <sub>O</sub> = 5mA to 1.5A	-	12	180	mV	
		T <sub>J</sub> = +25°C I <sub>O</sub> = 250mA to 750mA	-	4	90		
Quiescent Current	I <sub>Q</sub>	T <sub>J</sub> = +25°C	-	3	6	mA	
Quiescent Current Change	ΔI <sub>Q</sub>	I <sub>O</sub> = 5mA to 1A	-	0.05	0.5	mA	
		V <sub>I</sub> = -11.5V to -26V	-	0.1	1		
Temperature Coefficient of V <sub>D</sub>	ΔV <sub>O</sub> /ΔT	I <sub>O</sub> = 5mA	-	-0.6	-	mV/°C	
Output Noise Voltage	V <sub>N</sub>	f = 10Hz to 100kHz T <sub>A</sub> = +25°C	-	175	-	μV	
Ripple Rejection	RR	f = 120Hz ΔV <sub>I</sub> = 10V	54	60	-	dB	
Dropout Voltage	V <sub>D</sub>	T <sub>J</sub> = +25°C I <sub>O</sub> = 1A	-	2	-	V	
Short Circuit Current	I <sub>SC</sub>	T <sub>J</sub> = +25°C, V <sub>I</sub> = -35V	-	300	-	mA	
Peak Current	I <sub>PK</sub>	T <sub>J</sub> = +25°C	-	2.2	-	A	

**Note:**

1. Load and line regulation are specified at constant junction temperature. Changes in V<sub>O</sub> due to heating effects must be taken into account separately. Pulse testing with low duty is used.

**Electrical Characteristics (LM7910)** (Continued)(V<sub>I</sub> = -17V, I<sub>O</sub> = 500mA, 0°C ≤ T<sub>J</sub> ≤ +125°C, C<sub>I</sub> = 2.2μF, C<sub>O</sub> = 1μF, unless otherwise specified.)

Parameter	Symbol	Conditions	Min.	Typ.	Max.	Unit	
Output Voltage	V <sub>O</sub>	T <sub>J</sub> = +25°C	-9.6	-10	-10.4	V	
		I <sub>O</sub> = 5mA to 1A, P <sub>d</sub> ≤ 15W V <sub>I</sub> = -12V to -28	-9.5	-10	-10.5		
Line Regulation (Note1)	ΔV <sub>O</sub>	T <sub>J</sub> = +25°C	V <sub>I</sub> = -12.5V to -28V	-	12	200	mV
			V <sub>I</sub> = -14V to -20V	-	6	100	
Load Regulation (Note1)	ΔV <sub>O</sub>	T <sub>J</sub> = +25°C I <sub>O</sub> = 5mA to 1.5A	-	12	200	mV	
		T <sub>J</sub> = +25°C I <sub>O</sub> = 250mA to 750mA	-	4	100		
Quiescent Current	I <sub>Q</sub>	T <sub>J</sub> = +25°C	-	3	6	mA	
Quiescent Current Change	ΔI <sub>Q</sub>	I <sub>O</sub> = 5mA to 1A	-	0.05	0.5	mA	
		V <sub>I</sub> = -12.5V to -28V	-	0.1	1		
Temperature Coefficient of V <sub>O</sub>	ΔV <sub>O</sub> /ΔT	I <sub>O</sub> = 5mA	-	-1	-	mV/°C	
Output Noise Voltage	V <sub>N</sub>	10Hz ≤ f ≤ 100kHz T <sub>A</sub> = +25°C	-	280	-	μV	
Ripple Rejection	RR	f = 120Hz ΔV <sub>I</sub> = 10V	54	60	-	dB	
Dropout Voltage	V <sub>D</sub>	T <sub>J</sub> = +25°C I <sub>O</sub> = 1A	-	2	-	V	
Short Circuit Current	I <sub>SC</sub>	T <sub>J</sub> = +25°C, V <sub>I</sub> = -35V	-	300	-	mA	
Peak Current	I <sub>PK</sub>	T <sub>J</sub> = +25°C	-	2.2	-	A	

**Note:**

1. Load and line regulation are specified at constant junction temperature. Changes in V<sub>O</sub> due to heating effects must be taken into account separately. Pulse testing with low duty is used.

**Electrical Characteristics (LM7912)** (Continued)(V<sub>I</sub> = -19V, I<sub>O</sub> = 500mA, 0°C ≤ T<sub>J</sub> ≤ +125°C, C<sub>I</sub> = 2.2μF, C<sub>O</sub> = 1μF, unless otherwise specified.)

Parameter	Symbol	Conditions	Min.	Typ.	Max.	Unit	
Output Voltage	V <sub>O</sub>	T <sub>J</sub> = +25°C	-11.5	-12	-12.5	V	
		I <sub>O</sub> = 5mA to 1A, P <sub>O</sub> ≤ 15W V <sub>I</sub> = -15.5V to -27V	-11.4	-12	-12.6		
Line Regulation (Note1)	ΔV <sub>O</sub>	T <sub>J</sub> = +25°C	V <sub>I</sub> = -14.5V to -30V	-	12	240	mV
			V <sub>I</sub> = -16V to -22V	-	6	120	
Load Regulation (Note1)	ΔV <sub>O</sub>	T <sub>J</sub> = +25°C I <sub>O</sub> = 5mA to 1.5A	-	12	240	mV	
		T <sub>J</sub> = +25°C I <sub>O</sub> = 250mA to 750mA	-	4	120		
Quiescent Current	I <sub>Q</sub>	T <sub>J</sub> = +25°C	-	3	6	mA	
Quiescent Current Change	ΔI <sub>Q</sub>	I <sub>O</sub> = 5mA to 1A	-	0.05	0.5	mA	
		V <sub>I</sub> = -14.5V to -30V	-	0.1	1		
Temperature Coefficient of V <sub>D</sub>	ΔV <sub>O</sub> /ΔT	I <sub>O</sub> = 5mA	-	-0.8	-	mV/°C	
Output Noise Voltage	V <sub>N</sub>	f = 10Hz to 100kHz T <sub>A</sub> = +25°C	-	200	-	μV	
Ripple Rejection	RR	f = 120Hz ΔV <sub>I</sub> = 10V	54	60	-	dB	
Dropout Voltage	V <sub>D</sub>	T <sub>J</sub> = +25°C I <sub>O</sub> = 1A	-	2	-	V	
Short Circuit Current	I <sub>SC</sub>	T <sub>J</sub> = +25°C, V <sub>I</sub> = -35V	-	300	-	mA	
Peak Current	I <sub>PK</sub>	T <sub>J</sub> = +25°C	-	2.2	-	A	

**Note:**

1. Load and line regulation are specified at constant junction temperature. Changes in V<sub>O</sub> due to heating effects must be taken into account separately. Pulse testing with low duty is used.



**Electrical Characteristics (LM7915)** (Continued)(V<sub>I</sub> = -23V, I<sub>O</sub> = 500mA, 0°C ≤ T<sub>J</sub> ≤ +125°C, C<sub>I</sub> = 2.2μF, C<sub>O</sub> = 1μF, unless otherwise specified.)

Parameter	Symbol	Conditions	Min.	Typ.	Max.	Unit	
Output Voltage	V <sub>O</sub>	T <sub>J</sub> = +25°C	-14.4	-15	-15.6	V	
		I <sub>O</sub> = 5mA to 1A, P <sub>O</sub> ≤ 15W V <sub>I</sub> = -18V to -30V	-14.25	-15	-15.75		
Line Regulation (Note1)	ΔV <sub>O</sub>	T <sub>J</sub> = +25°C	V <sub>I</sub> = -17.5V to -30V	-	12	300	mV
			V <sub>I</sub> = -20V to -26V	-	6	150	
Load Regulation (Note1)	ΔV <sub>O</sub>	T <sub>J</sub> = +25°C I <sub>O</sub> = 5mA to 1.5A		-	12	300	mV
		T <sub>J</sub> = +25°C I <sub>O</sub> = 250mA to 750mA		-	4	150	
Quiescent Current	I <sub>Q</sub>	T <sub>J</sub> = +25°C	-	3	6	mA	
Quiescent Current Change	ΔI <sub>Q</sub>	I <sub>O</sub> = 5mA to 1A		-	0.05	0.5	mA
		V <sub>I</sub> = -17.5V to -30V		-	0.1	1	
Temperature Coefficient of V <sub>D</sub>	ΔV <sub>O</sub> /ΔT	I <sub>O</sub> = 5mA	-	-0.9	-	mV/°C	
Output Noise Voltage	V <sub>N</sub>	f = 10Hz to 100kHz T <sub>A</sub> = +25°C	-	250	-	μV	
Ripple Rejection	RR	f = 120Hz ΔV <sub>I</sub> = 10V	54	60	-	dB	
Dropout Voltage	V <sub>D</sub>	T <sub>J</sub> = +25°C I <sub>O</sub> = 1A	-	2	-	V	
Short Circuit Current	I <sub>SC</sub>	T <sub>J</sub> = +25°C, V <sub>I</sub> = -35V	-	300	-	mA	
Peak Current	I <sub>PK</sub>	T <sub>J</sub> = +25°C	-	2.2	-	A	

**Note:**

1. Load and line regulation are specified at constant junction temperature. Changes in V<sub>O</sub> due to heating effects must be taken into account separately. Pulse testing with low duty is used.

**Electrical Characteristics (LM7918)** (Continued)(V<sub>I</sub> = -27V, I<sub>O</sub> = 500mA, 0°C ≤ T<sub>J</sub> ≤ +125°C, C<sub>I</sub> = 2.2μF, C<sub>O</sub> = 1μF, unless otherwise specified.)

Parameter	Symbol	Conditions	Min.	Typ.	Max.	Unit	
Output Voltage	V <sub>O</sub>	T <sub>J</sub> = +25°C	-17.3	-18	-18.7	V	
		I <sub>O</sub> = 5mA to 1A, P <sub>O</sub> ≤ 15W V <sub>I</sub> = -22.5V to -33V	-17.1	-18	-18.9		
Line Regulation (Note1)	ΔV <sub>O</sub>	T <sub>J</sub> = +25°C	V <sub>I</sub> = -21V to -33V	-	15	360	mV
			V <sub>I</sub> = -24V to -30V	-	8	180	
Load Regulation (Note1)	ΔV <sub>O</sub>	T <sub>J</sub> = +25°C I <sub>O</sub> = 5mA to 1.5A		-	15	360	mV
		T <sub>J</sub> = +25°C I <sub>O</sub> = 250mA to 750mA		-	5	180	
Quiescent Current	I <sub>Q</sub>	T <sub>J</sub> = +25°C	-	3	6	mA	
Quiescent Current Change	ΔI <sub>Q</sub>	I <sub>O</sub> = 5mA to 1A	-	0.05	0.5	mA	
		V <sub>I</sub> = -21V to -33V	-	0.1	1		
Temperature Coefficient of V <sub>D</sub>	ΔV <sub>O</sub> /ΔT	I <sub>O</sub> = 5mA	-	-1	-	mV/°C	
Output Noise Voltage	V <sub>N</sub>	f = 10Hz to 100kHz T <sub>A</sub> = +25°C	-	300	-	μV	
Ripple Rejection	RR	f = 120Hz ΔV <sub>I</sub> = 10V	54	60	-	dB	
Dropout Voltage	V <sub>D</sub>	T <sub>J</sub> = +25°C I <sub>O</sub> = 1A	-	2	-	V	
Short Circuit Current	I <sub>SC</sub>	T <sub>J</sub> = +25°C, V <sub>I</sub> = -35V	-	300	-	mA	
Peak Current	I <sub>PK</sub>	T <sub>J</sub> = +25°C	-	2.2	-	A	

**Note:**

1. Load and line regulation are specified at constant junction temperature. Changes in V<sub>O</sub> due to heating effects must be taken into account separately. Pulse testing with low duty is used.

**Electrical Characteristics (LM7924)** (Continued)(V<sub>I</sub> = -33V, I<sub>O</sub> = 500mA, 0°C ≤ T<sub>J</sub> ≤ +125°C, C<sub>I</sub> = 2.2μF, C<sub>O</sub> = 1μF, unless otherwise specified.)

Parameter	Symbol	Conditions	Min.	Typ.	Max.	Unit	
Output Voltage	V <sub>O</sub>	T <sub>J</sub> = +25°C	-23	-24	-25	V	
		I <sub>O</sub> = 5mA to 1A, P <sub>O</sub> ≤ 15W V <sub>I</sub> = -27V to -38V	-22.8	-24	-25.2		
Line Regulation (Note1)	ΔV <sub>O</sub>	T <sub>J</sub> = +25°C	V <sub>I</sub> = -27V to -38V	-	15	480	mV
			V <sub>I</sub> = -30V to -36V	-	8	180	
Load Regulation (Note1)	ΔV <sub>O</sub>	T <sub>J</sub> = +25°C I <sub>O</sub> = 5mA to 1.5A	-	15	480	mV	
		T <sub>J</sub> = +25°C I <sub>O</sub> = 250mA to 750mA	-	5	240		
Quiescent Current	I <sub>Q</sub>	T <sub>J</sub> = +25°C	-	3	6	mA	
Quiescent Current Change	ΔI <sub>Q</sub>	I <sub>O</sub> = 5mA to 1A	-	0.05	0.5	mA	
		V <sub>I</sub> = -27V to -38V	-	0.1	1		
Temperature Coefficient of V <sub>D</sub>	ΔV <sub>O</sub> /ΔT	I <sub>O</sub> = 5mA	-	-1	-	mV/°C	
Output Noise Voltage	V <sub>N</sub>	f = 10Hz to 100kHz T <sub>A</sub> = +25°C	-	400	-	μV	
Ripple Rejection	RR	f = 120Hz ΔV <sub>I</sub> = 10V	54	60	-	dB	
Dropout Voltage	V <sub>D</sub>	T <sub>J</sub> = +25°C I <sub>O</sub> = 1A	-	2	-	V	
Short Circuit Current	I <sub>SC</sub>	T <sub>J</sub> = +25°C, V <sub>I</sub> = -35V	-	300	-	mA	
Peak Current	I <sub>PK</sub>	T <sub>J</sub> = +25°C	-	2.2	-	A	

**Note:**

1. Load and line regulation are specified at constant junction temperature. Changes in V<sub>O</sub> due to heating effects must be taken into account separately. Pulse testing with low duty is used.

# Typical Performance Characteristics

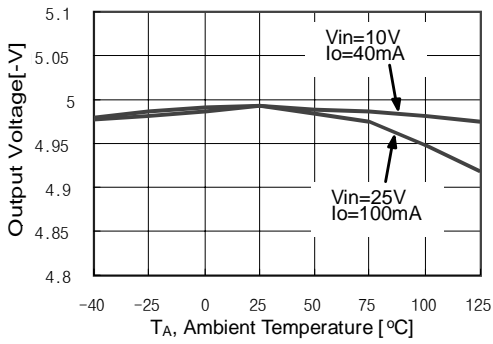

Figure 1. Output Voltage

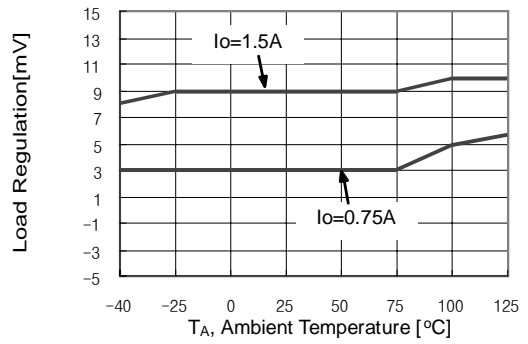

Figure 2. Load Regulation

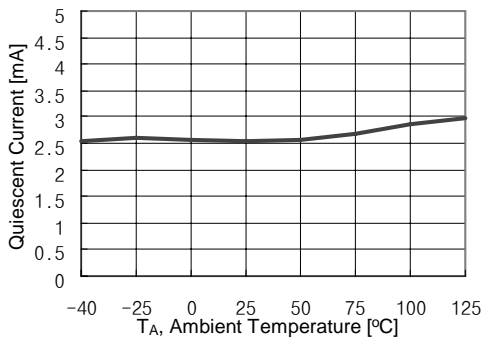

Figure 3. Quiescent Current

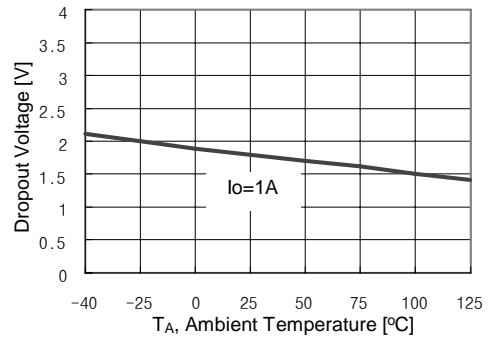

Figure 4. Dropout Voltage

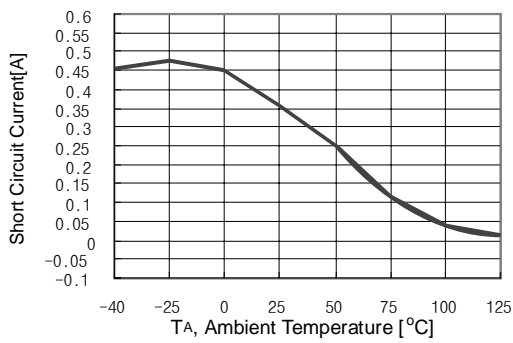

Figure 5. Short Circuit Current

## Typical Applications

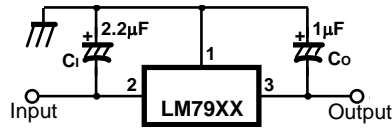

Figure 6. Negative Fixed output regulator

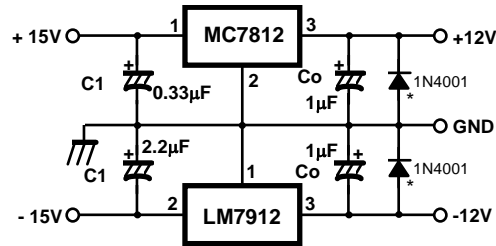

Figure 7. Split power supply ( ± 12V/1A)

**Notes:**

- (1) To specify an output voltage, substitute voltage value for "XX "
- (2) Required for stability. For value given, capacitor must be solid tantalum. If aluminium electronics are used, at least ten times value shown should be selected. C<sub>1</sub> is required if regulator is located an appreciable distance from power supply filter.
- (3) To improve transient response. If large capacitors are used, a high current diode from input to output (1N4001 or similar) should be introduced to protect the device from momentary input short circuit.

# Mechanical Dimensions

## Package

Dimensions in millimeters

### TO-220 [ SINGLE GAUGE ]

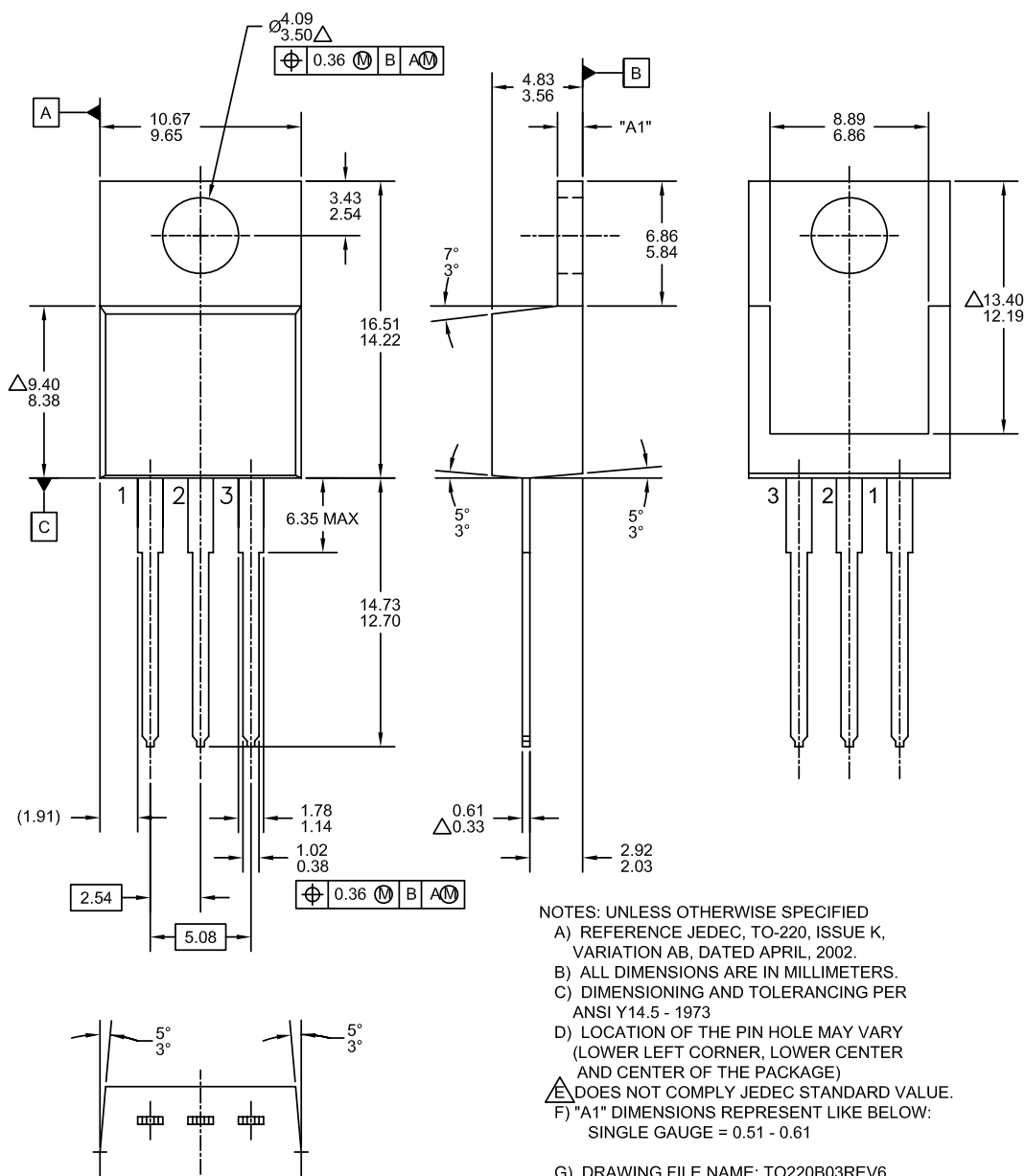

- NOTES: UNLESS OTHERWISE SPECIFIED
- A) REFERENCE JEDEC, TO-220, ISSUE K, VARIATION AB, DATED APRIL, 2002.
  - B) ALL DIMENSIONS ARE IN MILLIMETERS.
  - C) DIMENSIONING AND TOLERANCING PER ANSI Y14.5 - 1973
  - D) LOCATION OF THE PIN HOLE MAY VARY (LOWER LEFT CORNER, LOWER CENTER AND CENTER OF THE PACKAGE)
  - E) DOES NOT COMPLY JEDEC STANDARD VALUE.
  - F) "A1" DIMENSIONS REPRESENT LIKE BELOW:  
SINGLE GAUGE = 0.51 - 0.61
  - G) DRAWING FILE NAME: TO220B03REV6

## Ordering Information

Product Number	Output Voltage Tolerance	Package	Operating Temperature
LM7905CT	±4%	TO-220 (Single Gauge)	0 ~ +125°C
LM7906CT			
LM7908CT			
LM7909CT			
LM7910CT			
LM7912CT			
LM7915CT			
LM7918CT			
LM7924CT			

**DISCLAIMER**

FAIRCHILD SEMICONDUCTOR RESERVES THE RIGHT TO MAKE CHANGES WITHOUT FURTHER NOTICE TO ANY PRODUCTS HEREIN TO IMPROVE RELIABILITY, FUNCTION OR DESIGN. FAIRCHILD DOES NOT ASSUME ANY LIABILITY ARISING OUT OF THE APPLICATION OR USE OF ANY PRODUCT OR CIRCUIT DESCRIBED HEREIN; NEITHER DOES IT CONVEY ANY LICENSE UNDER ITS PATENT RIGHTS, NOR THE RIGHTS OF OTHERS.

**LIFE SUPPORT POLICY**

FAIRCHILD'S PRODUCTS ARE NOT AUTHORIZED FOR USE AS CRITICAL COMPONENTS IN LIFE SUPPORT DEVICES OR SYSTEMS WITHOUT THE EXPRESS WRITTEN APPROVAL OF THE PRESIDENT OF FAIRCHILD SEMICONDUCTOR CORPORATION. As used herein:

1. Life support devices or systems are devices or systems which, (a) are intended for surgical implant into the body, or (b) support or sustain life, and (c) whose failure to perform when properly used in accordance with instructions for use provided in the labeling, can be reasonably expected to result in a significant injury of the user.
2. A critical component in any component of a life support device or system whose failure to perform can be reasonably expected to cause the failure of the life support device or system, or to affect its safety or effectiveness.



ON Semiconductor and  are trademarks of Semiconductor Components Industries, LLC dba ON Semiconductor or its subsidiaries in the United States and/or other countries. ON Semiconductor owns the rights to a number of patents, trademarks, copyrights, trade secrets, and other intellectual property. A listing of ON Semiconductor's product/patent coverage may be accessed at [www.onsemi.com/site/pdf/Patent-Marking.pdf](http://www.onsemi.com/site/pdf/Patent-Marking.pdf). ON Semiconductor reserves the right to make changes without further notice to any products herein. ON Semiconductor makes no warranty, representation or guarantee regarding the suitability of its products for any particular purpose, nor does ON Semiconductor assume any liability arising out of the application or use of any product or circuit, and specifically disclaims any and all liability, including without limitation special, consequential or incidental damages. Buyer is responsible for its products and applications using ON Semiconductor products, including compliance with all laws, regulations and safety requirements or standards, regardless of any support or applications information provided by ON Semiconductor. "Typical" parameters which may be provided in ON Semiconductor data sheets and/or specifications can and do vary in different applications and actual performance may vary over time. All operating parameters, including "Typicals" must be validated for each customer application by customer's technical experts. ON Semiconductor does not convey any license under its patent rights nor the rights of others. ON Semiconductor products are not designed, intended, or authorized for use as a critical component in life support systems or any FDA Class 3 medical devices or medical devices with a same or similar classification in a foreign jurisdiction or any devices intended for implantation in the human body. Should Buyer purchase or use ON Semiconductor products for any such unintended or unauthorized application, Buyer shall indemnify and hold ON Semiconductor and its officers, employees, subsidiaries, affiliates, and distributors harmless against all claims, costs, damages, and expenses, and reasonable attorney fees arising out of, directly or indirectly, any claim of personal injury or death associated with such unintended or unauthorized use, even if such claim alleges that ON Semiconductor was negligent regarding the design or manufacture of the part. ON Semiconductor is an Equal Opportunity/Affirmative Action Employer. This literature is subject to all applicable copyright laws and is not for resale in any manner.

## PUBLICATION ORDERING INFORMATION

### LITERATURE FULFILLMENT:

Literature Distribution Center for ON Semiconductor  
19521 E. 32nd Pkwy, Aurora, Colorado 80011 USA  
**Phone:** 303-675-2175 or 800-344-3860 Toll Free USA/Canada  
**Fax:** 303-675-2176 or 800-344-3867 Toll Free USA/Canada  
**Email:** [orderlit@onsemi.com](mailto:orderlit@onsemi.com)

**N. American Technical Support:** 800-282-9855 Toll Free  
USA/Canada  
**Europe, Middle East and Africa Technical Support:**  
Phone: 421 33 790 2910  
**Japan Customer Focus Center**  
Phone: 81-3-5817-1050

**ON Semiconductor Website:** [www.onsemi.com](http://www.onsemi.com)  
**Order Literature:** <http://www.onsemi.com/orderlit>  
For additional information, please contact your local  
Sales Representative

# Mouser Electronics

Authorized Distributor

Click to View Pricing, Inventory, Delivery & Lifecycle Information:

[ON Semiconductor:](#)

[LM7915CT](#)