

NUMBER C-175151



METRIC

単位: mm DIMENSIONS IN MM. DO NOT SCALE PRINT

PRINT DIST

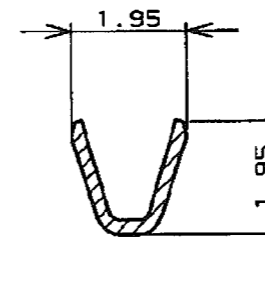
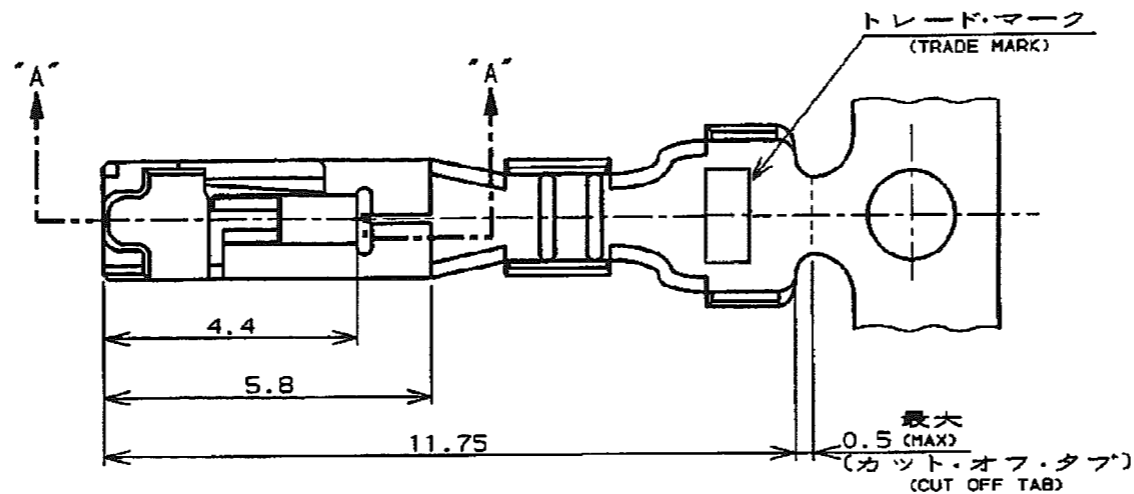

断面 "D"- "D"  
(SECT)

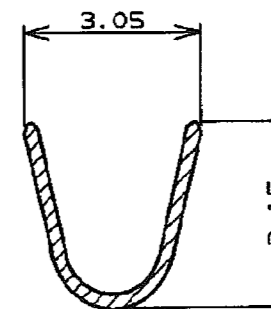

断面 "E"- "E"  
(SECT)

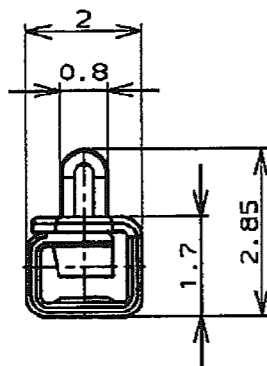

断面 "B"- "B"  
(SECT)

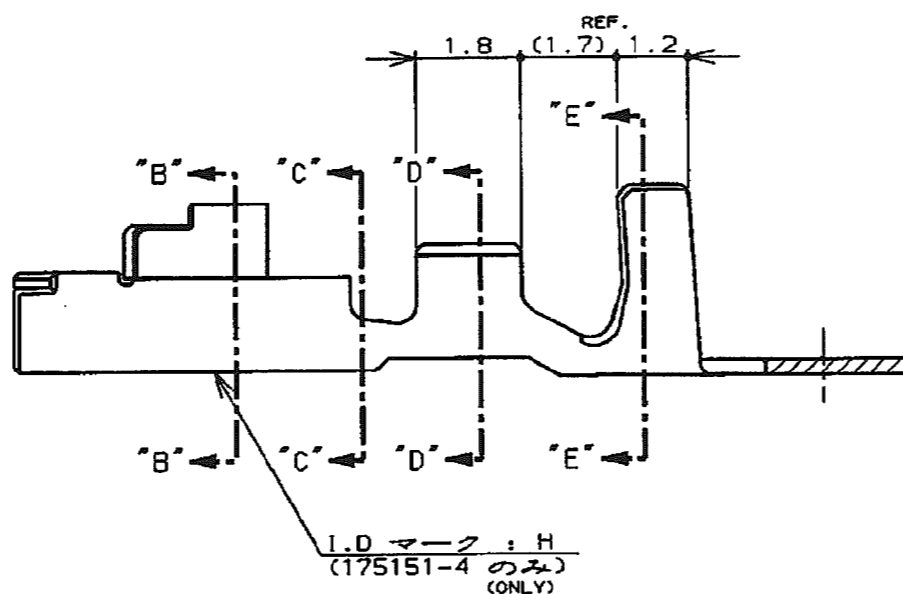

断面 "A"- "A"  
(SECT) (175151-1, -2)

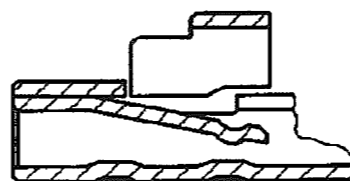

断面 "A"- "A"  
(SECT) (175151-4)

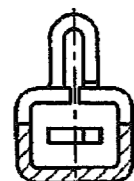

断面 "C"- "C"  
(SECT)

L.D マーク : H  
(175151-4 のみ)  
(ONLY)

注記 :

- 適用規格  
製品規格 : 108-5302  
取付適用規格 : 114-5142
- 取扱説明書 : IS-503J

NOTES:

- APPLICABLE SPEC  
PRODUCT SPEC : 108-5302  
APPLICATION SPEC : 114-5142
- INSTRUTION SHEET : IS-503J

	NYE: 502H-20-UV 1L7"カトオ化処理 (APPLIED LUBRICANT OIL)	錫めつき黄銅 (PRE TINNED BRASS)	175151-5
175155-4	---	錫めつき黄銅合金 (PRE TINNED COPPER ALLOY)	175151-4
175155-2	---	錫めつき黄銅 (PRE TINNED BRASS)	175151-2
175155-1	---	錫めつき黄銅合金 (PRE TINNED COPPER ALLOY)	175151-1
バラ状端子型番 (L.P P/N)	仕上 (FINISH)	材料 (MATERIAL)	型番 (P/N)



適合電線断面積 (WIRE RANGE) 0.12~0.35mm <sup>2</sup> (AWG#26~22)	被覆外径 (INSULATION DIA.) 1.2~2 mmφ	名称 (NAME) リセクタクル・コンタクト、アンプ・ユニバーサル・パワー・コネクタ (REC CONTACT AMP UNIVERSAL POWER CONN.)
材料 (MATERIAL) 表参照 (SEE TABLE)	仕上 (FINISH) 表参照 (SEE TABLE)	一般公差 (GENERAL TOLERANCE) 10以下: ±0.2 10~30以下: ±0.25 30~100以下: ±0.3 角 度: ±3°
DR. 8. JUN '95 N. NAGASHIMA	DE. 8. JUN '95 M. SHINDO	LOC B J
CHK. 8. JUN '95 M. SHINDO	APP. 8. JUN '95 Y. KASHIWA	番号 (No.) C-175151
F1 REVISED PER ECO-11-005030	RK HMR 01APR11	尺度 (SCALE) ---
LTR 変更 (REVISION RECORD)	DR CHK DATE	REV. F1 SHEET 1 OF 1

(CUSTOMER DRAWING) 参 考 区 画

# Mouser Electronics

Authorized Distributor

Click to View Pricing, Inventory, Delivery & Lifecycle Information:

[TE Connectivity:](#)

[175151-5](#)