



Is Now Part of



ON Semiconductor®

To learn more about ON Semiconductor, please visit our website at
www.onsemi.com

Please note: As part of the Fairchild Semiconductor integration, some of the Fairchild orderable part numbers will need to change in order to meet ON Semiconductor's system requirements. Since the ON Semiconductor product management systems do not have the ability to manage part nomenclature that utilizes an underscore (_), the underscore (_) in the Fairchild part numbers will be changed to a dash (-). This document may contain device numbers with an underscore (_). Please check the ON Semiconductor website to verify the updated device numbers. The most current and up-to-date ordering information can be found at www.onsemi.com. Please email any questions regarding the system integration to Fairchild_questions@onsemi.com.

ON Semiconductor and the ON Semiconductor logo are trademarks of Semiconductor Components Industries, LLC dba ON Semiconductor or its subsidiaries in the United States and/or other countries. ON Semiconductor owns the rights to a number of patents, trademarks, copyrights, trade secrets, and other intellectual property. A listing of ON Semiconductor's product/patent coverage may be accessed at www.onsemi.com/site/pdf/Patent-Marking.pdf. ON Semiconductor reserves the right to make changes without further notice to any products herein. ON Semiconductor makes no warranty, representation or guarantee regarding the suitability of its products for any particular purpose, nor does ON Semiconductor assume any liability arising out of the application or use of any product or circuit, and specifically disclaims any and all liability, including without limitation special, consequential or incidental damages. Buyer is responsible for its products and applications using ON Semiconductor products, including compliance with all laws, regulations and safety requirements or standards, regardless of any support or applications information provided by ON Semiconductor. "Typical" parameters which may be provided in ON Semiconductor data sheets and/or specifications can and do vary in different applications and actual performance may vary over time. All operating parameters, including "Typicals" must be validated for each customer application by customer's technical experts. ON Semiconductor does not convey any license under its patent rights nor the rights of others. ON Semiconductor products are not designed, intended, or authorized for use as a critical component in life support systems or any FDA Class 3 medical devices or medical devices with a same or similar classification in a foreign jurisdiction or any devices intended for implantation in the human body. Should Buyer purchase or use ON Semiconductor products for any such unintended or unauthorized application, Buyer shall indemnify and hold ON Semiconductor and its officers, employees, subsidiaries, affiliates, and distributors harmless against all claims, costs, damages, and expenses, and reasonable attorney fees arising out of, directly or indirectly, any claim of personal injury or death associated with such unintended or unauthorized use, even if such claim alleges that ON Semiconductor was negligent regarding the design or manufacture of the part. ON Semiconductor is an Equal Opportunity/Affirmative Action Employer. This literature is subject to all applicable copyright laws and is not for resale in any manner.



FAN3121 / FAN3122

Single 9-A High-Speed, Low-Side Gate Driver

Features

- Industry-Standard Pin-out with Enable Input
- 4.5-V to 18-V Operating Range
- 11.4 A Peak Sink at $V_{DD} = 12\text{ V}$
- 9.7-A Sink / 7.1-A Source at $V_{OUT} = 6\text{ V}$
- Inverting Configuration (FAN3121) and Non-Inverting Configuration (FAN3122)
- Internal Resistors Turn Driver Off If No Inputs
- 23-ns / 19-ns Typical Rise/Fall Times (10 nF Load)
- 18 ns to 23 ns Typical Propagation Delay Time
- Choice of TTL or CMOS Input Thresholds
- MillerDrive™ Technology
- Available in Thermally Enhanced 3x3 mm 8-Lead MLP or 8-Lead SOIC Package (Pb-Free Finish)
- Rated from -40°C to $+125^{\circ}\text{C}$
- Automotive Qualified to AEC-Q100 (F085 Versions)

Applications

- Synchronous Rectifier Circuits
- High-Efficiency MOSFET Switching
- Switch-Mode Power Supplies
- DC-to-DC Converters
- Motor Control
- Automotive-Qualified Systems (F085 Versions)

Description

The FAN3121 and FAN3122 MOSFET drivers are designed to drive N-channel enhancement MOSFETs in low-side switching applications by providing high peak current pulses. The drivers are available with either TTL input thresholds (FAN312xT) or V_{DD} -proportional CMOS input thresholds (FAN312xC). Internal circuitry provides an under-voltage lockout function by holding the output low until the supply voltage is within the operating range.

FAN312x drivers incorporate the MillerDrive™ architecture for the final output stage. This bipolar / MOSFET combination provides the highest peak current during the Miller plateau stage of the MOSFET turn-on / turn-off process.

The FAN3121 and FAN3122 drivers implement an enable function on pin 3 (EN), previously unused in the industry-standard pin-out. The pin is internally pulled up to V_{DD} for active HIGH logic and can be left open for standard operation.

The commercial FAN3121/22 is available in a 3x3 mm 8-lead thermally-enhanced MLP package or an 8-lead SOIC package. The AEC-Q100 automotive-qualified versions are available in the 8-lead SOIC package.

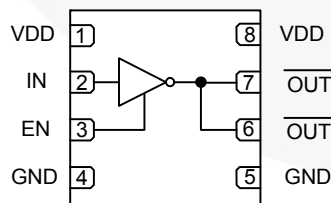

Figure 1. FAN3121 Pin Configuration

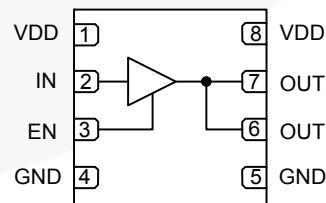

Figure 2. FAN3122 Pin Configuration

Ordering Information

| Part Number | Logic | Input Threshold | Package | Packing Method | Quantity per Reel |
|--------------------------------|---------------------------------|-----------------|--------------|----------------|-------------------|
| FAN3121CMPX | Inverting Channels + Enable | CMOS | 3x3 mm MLP-8 | Tape & Reel | 3,000 |
| FAN3121CMX | | | SOIC-8 | Tape & Reel | 2,500 |
| FAN3121CMX_F085 ⁽¹⁾ | | | SOIC-8 | Tape & Reel | 2,500 |
| FAN3121TMPX | | TTL | 3x3 mm MLP-8 | Tape & Reel | 3,000 |
| FAN3121TMX | | | SOIC-8 | Tape & Reel | 2,500 |
| FAN3121TMX_F085 ⁽¹⁾ | | | SOIC-8 | Tape & Reel | 2,500 |
| FAN3122CMPX | Non-Inverting Channels + Enable | CMOS | 3x3 mm MLP-8 | Tape & Reel | 3,000 |
| FAN3122CMX | | | SOIC-8 | Tape & Reel | 2,500 |
| FAN3122CMX_F085 ⁽¹⁾ | | | SOIC-8 | Tape & Reel | 2,500 |
| FAN3122TMPX | | TTL | 3x3 mm MLP-8 | Tape & Reel | 3,000 |
| FAN3122TMX | | | SOIC-8 | Tape & Reel | 2,500 |
| FAN3122TMX_F085 ⁽¹⁾ | | | SOIC-8 | Tape & Reel | 2,500 |

For additional information on Fairchild's Eco Status, please visit: http://www.fairchildsemi.com/company/green/rohs_green.html

Note:

1. Qualified to AEC-Q100.

Package Outlines

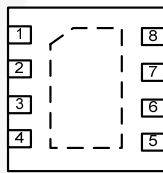

Figure 3. 3x3 mm MLP-8 (Top View)

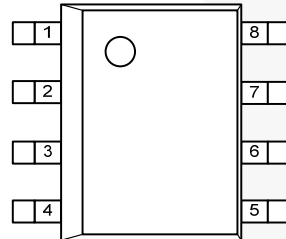

Figure 4. SOIC-8 (Top View)

Thermal Characteristics⁽²⁾

| Package | Θ_{JL} ⁽³⁾ | Θ_{JT} ⁽⁴⁾ | Θ_{JA} ⁽⁵⁾ | Ψ_{JB} ⁽⁶⁾ | Ψ_{JT} ⁽⁷⁾ | Units |
|---|------------------------------|------------------------------|------------------------------|----------------------------|----------------------------|-------|
| 8-Lead 3x3 mm Molded Leadless Package (MLP) | 1.2 | 64 | 42 | 2.8 | 0.7 | °C/W |
| 8-Pin Small Outline Integrated Circuit (SOIC) | 38 | 29 | 87 | 41 | 2.3 | °C/W |

Notes:

2. Estimates derived from thermal simulation; actual values depend on the application.
3. Θ_{JL} (Θ_{JL}): Thermal resistance between the semiconductor junction and the bottom surface of all the leads (including any thermal pad) that are typically soldered to a PCB.
4. Θ_{JT} (Θ_{JT}): Thermal resistance between the semiconductor junction and the top surface of the package, assuming it is held at a uniform temperature by a top-side heatsink.
5. Θ_{JA} (Θ_{JA}): Thermal resistance between junction and ambient, dependent on the PCB design, heat sinking, and airflow. The value given is for natural convection with no heatsink, as specified in JEDEC standards JESD51-2, JESD51-5, and JESD51-7, as appropriate.
6. Ψ_{JB} (Ψ_{JB}): Thermal characterization parameter providing correlation between semiconductor junction temperature and an application circuit board reference point for the thermal environment defined in Note 5. For the MLP-8 package, the board reference is defined as the PCB copper connected to the thermal pad and protruding from either end of the package. For the SOIC-8 package, the board reference is defined as the PCB copper adjacent to pin 6.
7. Ψ_{JT} (Ψ_{JT}): Thermal characterization parameter providing correlation between the semiconductor junction temperature and the center of the top of the package for the thermal environment defined in Note 5.

Pin Definitions

| FAN3121 | FAN3122 | Name | Description |
|---------|---------|-------------------------|---|
| 3 | 3 | EN | Enable Input. Pull pin LOW to inhibit driver. EN has logic thresholds for both TTL and CMOS IN thresholds. |
| 4, 5 | 4, 5 | GND | Ground. Common ground reference for input and output circuits. |
| 2 | 2 | IN | Input. |
| | 6, 7 | OUT | Gate Drive Output. Held LOW unless required input is present and V_{DD} is above the UVLO threshold. |
| 6, 7 | | $\overline{\text{OUT}}$ | Gate Drive Output (inverted from the input). Held LOW unless required input is present and V_{DD} is above the UVLO threshold. |
| 1, 8 | 1, 8 | V_{DD} | Supply Voltage. Provides power to the IC. |
| | | P1 | Thermal Pad (MLP only). Exposed metal on the bottom of the package; may be left floating or connected to GND; NOT suitable for carrying current. |

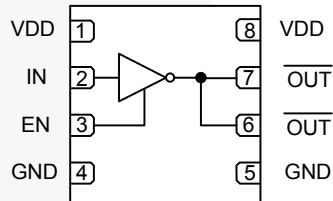

Figure 5. FAN3121 Pin Assignments (Repeated)

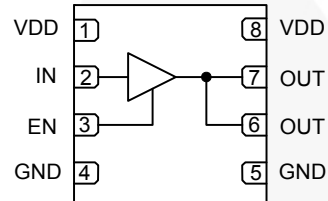

Figure 6. FAN3122 Pin Assignments (Repeated)

Output Logic

| FAN3121 | | |
|------------------|------------------|-------------------------|
| EN | IN | $\overline{\text{OUT}}$ |
| 0 | 0 | 0 |
| 0 | 1 ⁽⁸⁾ | 0 |
| 1 ⁽⁸⁾ | 0 | 1 |
| 1 ⁽⁸⁾ | 1 ⁽⁸⁾ | 0 |

| FAN3122 | | |
|------------------|------------------|-----|
| EN | IN | OUT |
| 0 | 0 ⁽⁸⁾ | 0 |
| 0 | 1 | 0 |
| 1 ⁽⁸⁾ | 0 ⁽⁸⁾ | 0 |
| 1 ⁽⁸⁾ | 1 | 1 |

Note:

8. Default input signal if no external connection is made.

Block Diagram

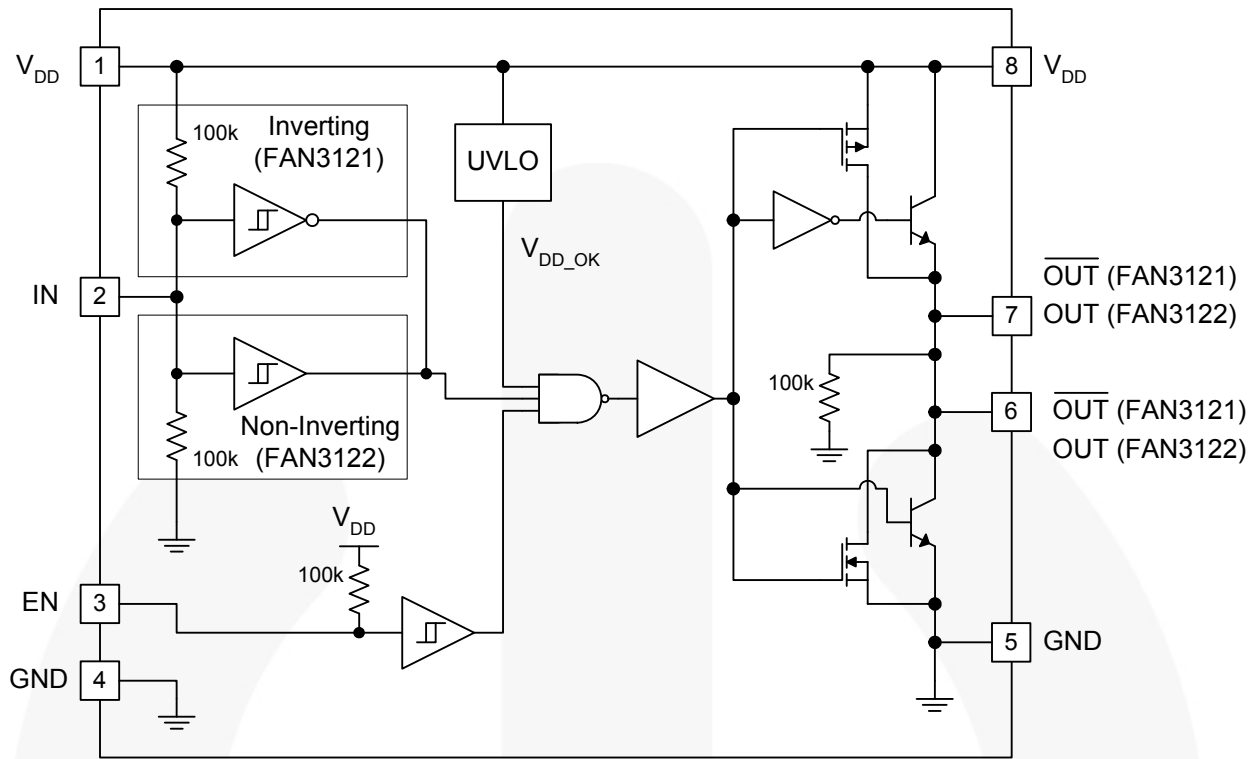

Figure 7. Block Diagram

Absolute Maximum Ratings

Stresses exceeding the absolute maximum ratings may damage the device. The device may not function or be operable above the recommended operating conditions and stressing the parts to these levels is not recommended. In addition, extended exposure to stresses above the recommended operating conditions may affect device reliability. The absolute maximum ratings are stress ratings only.

| Symbol | Parameter | Min. | Max. | Unit |
|-----------|---|-----------|----------------|------|
| V_{DD} | V_{DD} to GND | -0.3 | 20.0 | V |
| V_{EN} | EN to GND | GND - 0.3 | $V_{DD} + 0.3$ | V |
| V_{IN} | IN to GND | GND - 0.3 | $V_{DD} + 0.3$ | V |
| V_{OUT} | OUT to GND | GND - 0.3 | $V_{DD} + 0.3$ | V |
| T_L | Lead Soldering Temperature (10 Seconds) | | +260 | °C |
| T_J | Junction Temperature | -55 | +150 | °C |
| T_{STG} | Storage Temperature | -65 | +150 | °C |

Recommended Operating Conditions

The Recommended Operating Conditions table defines the conditions for actual device operation. Recommended operating conditions are specified to ensure optimal performance to the datasheet specifications. Fairchild does not recommend exceeding them or designing to Absolute Maximum Ratings.

| Symbol | Parameter | Min. | Max. | Unit |
|----------|-------------------------------|------|----------|------|
| V_{DD} | Supply Voltage Range | 4.5 | 18.0 | V |
| V_{EN} | Enable Voltage EN | 0 | V_{DD} | V |
| V_{IN} | Input Voltage IN | 0 | V_{DD} | V |
| T_A | Operating Ambient Temperature | -40 | +125 | °C |

Electrical Characteristics

Unless otherwise noted, $V_{DD}=12\text{ V}$ and $T_J=-40^\circ\text{C}$ to $+125^\circ\text{C}$. Currents are defined as positive into the device and negative out of the device.

| Symbol | Parameter | Conditions | Min. | Typ. | Max. | Unit |
|--|--|-----------------------|------|------|------|---------------|
| Supply | | | | | | |
| V_{DD} | Operating Range | | 4.5 | | 18.0 | V |
| I_{DD} | Supply Current, Inputs / EN Not Connected | TTL | | 0.65 | 0.90 | mA |
| | | CMOS ⁽⁹⁾ | | 0.58 | 0.85 | |
| V_{ON} | Device Turn-On Voltage (UVLO) | | 3.5 | 4.0 | 4.3 | V |
| V_{OFF} | Device Turn-Off Voltage (UVLO) | | 3.30 | 3.75 | 4.10 | V |
| FAN3121_F085, FAN3122_F085 (Automotive-Qualified Versions) | | | | | | |
| V_{DD} | Operating Range | | 4.5 | | 18.0 | V |
| I_{DD} | Supply Current, Inputs / EN Not Connected | TTL | | 0.65 | 1.00 | mA |
| | | CMOS ⁽⁹⁾ | | 0.58 | 0.85 | |
| V_{ON} | Device Turn-On Voltage (UVLO) | | 3.5 | 4.0 | 4.3 | V |
| V_{OFF} | Device Turn-Off Voltage (UVLO) ⁽¹³⁾ | | 3.25 | 3.75 | 4.15 | V |
| Inputs (TTL, FAN312xT)⁽¹⁰⁾ | | | | | | |
| V_{IL_T} | INx Logic Low Threshold | | 0.8 | 1.0 | | V |
| V_{IH_T} | INx Logic High Threshold | | | 1.7 | 2.0 | V |
| V_{HYS_T} | TTL Logic Hysteresis Voltage | | 0.40 | 0.70 | 0.85 | V |
| FAN3121TMX, FAN3122TMX | | | | | | |
| I_{IN+} | Non-Inverting Input Current | IN from 0 to V_{DD} | -1 | | 175 | μA |
| I_{IN-} | Inverting Input Current | IN from 0 to V_{DD} | -175 | | 1 | μA |
| FAN3121TMX_F085, FAN3122TMX_F085 (Automotive-Qualified Versions) | | | | | | |
| I_{INX_T} | Non-inverting Input Current ⁽¹³⁾ | IN=0 V | -1.5 | | 1.5 | μA |
| I_{INX_T} | Non-inverting Input Current ⁽¹³⁾ | IN= V_{DD} | 90 | 120 | 175 | μA |
| I_{INX_T} | Inverting Input Current ⁽¹³⁾ | IN=0 V | -175 | -120 | -90 | μA |
| I_{INX_T} | Inverting Input Current ⁽¹³⁾ | IN= V_{DD} | -1.5 | | 1.5 | μA |
| Inputs (CMOS, FAN312xC)⁽¹⁰⁾ | | | | | | |
| V_{IL_C} | INx Logic Low Threshold | | 30 | 38 | | $\%V_{DD}$ |
| V_{IH_C} | INx Logic High Threshold | | | 55 | 70 | $\%V_{DD}$ |
| V_{HYS_C} | CMOS Logic Hysteresis Voltage | | 12 | 17 | 24 | $\%V_{DD}$ |
| FAN3121CMX, FAN3122CMX | | | | | | |
| I_{IN+} | Non-Inverting Input Current | IN from 0 to V_{DD} | -1 | | 175 | μA |
| I_{IN-} | Inverting Input Current | IN from 0 to V_{DD} | -175 | | 1 | μA |
| FAN3121CMX_F085, FAN3122CMX_F085 (Automotive-Qualified Versions) | | | | | | |
| I_{INX_C} | Non-Inverting Input Current ⁽¹³⁾ | IN=0 V | -1.5 | | 1.5 | μA |
| I_{INX_C} | Non-Inverting Input Current ⁽¹³⁾ | IN= V_{DD} | 90 | 120 | 175 | μA |
| I_{INX_C} | Inverting Input Current ⁽¹³⁾ | IN=0 V | -175 | -120 | -90 | μA |
| I_{INX_C} | Inverting Input Current ⁽¹³⁾ | IN= V_{DD} | -1.5 | | 1.5 | μA |

Continued on the following page...

Electrical Characteristics (Continued)

Unless otherwise noted, $V_{DD}=12\text{ V}$ and $T_J=-40^\circ\text{C}$ to $+125^\circ\text{C}$. Currents are defined as positive into the device and negative out of the device.

| Symbol | Parameter | Conditions | Min. | Typ. | Max. | Unit |
|--|---|--|------|------|------|------------|
| ENABLE (FAN3121, FAN3122) | | | | | | |
| V_{ENL} | Enable Logic Low Threshold | EN from 5 V to 0 V | 1.2 | 1.6 | 2.0 | V |
| V_{ENH} | Enable Logic High Threshold | EN from 0 V to 5 V | 1.8 | 2.2 | 2.6 | V |
| V_{HYS_T} | TTL Logic Hysteresis Voltage | | 0.2 | 0.6 | 0.8 | V |
| R_{PU} | Enable Pull-up Resistance | | 68 | 100 | 134 | k Ω |
| t_{D1}, t_{D2} | Propagation Delay, CMOS EN ⁽¹¹⁾ | | 8 | 17 | 27 | ns |
| t_{D1}, t_{D2} | Propagation Delay, TTL EN ⁽¹¹⁾ | | 14 | 21 | 33 | ns |
| ENABLE (FAN3121_F085, FAN3122_F085) (Automotive-Qualified Versions) | | | | | | |
| V_{ENL} | Enable Logic Low Threshold | EN from 5 V to 0 V | 1.2 | 1.6 | 2.0 | V |
| V_{ENH} | Enable Logic High Threshold | EN from 0 V to 5 V | 1.8 | 2.2 | 2.6 | V |
| V_{HYS_T} | TTL Logic Hysteresis Voltage | | 0.20 | 0.60 | 0.85 | V |
| R_{PU} | Enable Pull-up Resistance | | 68 | 100 | 134 | k Ω |
| t_{D1}, t_{D2} | Propagation Delay, CMOS EN ⁽¹¹⁾ | | 6 | 17 | 35 | ns |
| t_{D1}, t_{D2} | Propagation Delay, TTL EN ⁽¹¹⁾ | | 8 | 22 | 34 | ns |
| Outputs | | | | | | |
| I_{SINK} | OUT Current, Mid-Voltage, Sinking ⁽¹²⁾ | OUT at $V_{DD}/2$, $C_{LOAD}=1.0\ \mu\text{F}$, $f=1\ \text{kHz}$ | | 9.7 | | A |
| I_{SOURCE} | OUT Current, Mid-Voltage, Sourcing ⁽¹²⁾ | OUT at $V_{DD}/2$, $C_{LOAD}=1.0\ \mu\text{F}$, $f=1\ \text{kHz}$ | | 7.1 | | A |
| I_{PK_SINK} | OUT Current, Peak, Sinking ⁽¹²⁾ | $C_{LOAD}=1.0\ \mu\text{F}$, $f=1\ \text{kHz}$ | | 11.4 | | A |
| I_{PK_SOURCE} | OUT Current, Peak, Sourcing ⁽¹²⁾ | $C_{LOAD}=1.0\ \mu\text{F}$, $f=1\ \text{kHz}$ | | 10.6 | | A |
| t_{RISE} | Output Rise Time ⁽¹¹⁾ | $C_{LOAD}=10\ \text{nF}$ | 18 | 23 | 29 | ns |
| t_{FALL} | Output Fall Time ⁽¹¹⁾ | $C_{LOAD}=10\ \text{nF}$ | 11 | 19 | 27 | ns |
| t_{D1}, t_{D2} | Output Propagation Delay, CMOS Inputs ⁽¹¹⁾ | 0 – 12 V_{IN} , 1 V/ns Slew Rate | 9 | 18 | 28 | ns |
| t_{D1}, t_{D2} | Output Propagation Delay, TTL Inputs ⁽¹¹⁾ | 0 – 5 V_{IN} , 1 V/ns Slew Rate | 9 | 23 | 35 | ns |
| I_{RVS} | Output Reverse Current Withstand ⁽¹²⁾ | | 1500 | | | mA |
| FAN3121_F085, FAN3122_F085 (Automotive-Qualified Versions) | | | | | | |
| t_{RISE} | Output Rise Time ⁽¹¹⁾ CMOS Inputs | $C_{LOAD}=10\ \text{nF}$ | 12 | 23 | 31 | ns |
| t_{FALL} | Output Fall Time ⁽¹¹⁾ CMOS Inputs | $C_{LOAD}=10\ \text{nF}$ | 12 | 19 | 27 | ns |
| t_{RISE} | Output Rise Time ⁽¹¹⁾ TTL Inputs | $C_{LOAD}=10\ \text{nF}$ | 18 | 23 | 36 | ns |
| t_{FALL} | Output Fall Time ⁽¹¹⁾ TTL Inputs | $C_{LOAD}=10\ \text{nF}$ | 10 | 19 | 28 | ns |
| t_{D1}, t_{D2} | Output Propagation Delay, CMOS Inputs ⁽¹³⁾ | 0 – 12 V_{IN} , 1 V/ns Slew Rate | 6 | 18 | 35 | ns |
| t_{D1}, t_{D2} | Output Propagation Delay, TTL Inputs ⁽¹¹⁾ | 0 – 5 V_{IN} , 1 V/ns Slew Rate | 9 | 23 | 36 | ns |
| V_{OH} | High Level Output Voltage ⁽¹³⁾ | $V_{OH}=V_{DD}-V_{OUT}$, $I_{OUT}=-1\ \text{mA}$ | | 15 | 35 | mV |
| V_{OL} | Low Level Output Voltage ⁽¹³⁾ | $I_{OUT}=1\ \text{mA}$ | | 10 | 25 | mV |

Notes:

9. Lower supply current due to inactive TTL circuitry.
10. EN inputs have modified TTL thresholds; refer to the ENABLE section.
11. See *Timing Diagrams of Figure 8 and Figure 9*.
12. Not tested in production.
13. Automotive-qualified F085 version specifications.

Timing Diagrams

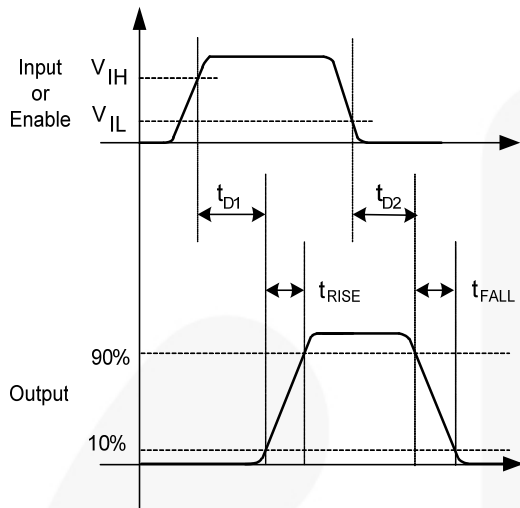

Figure 8. Non-Inverting

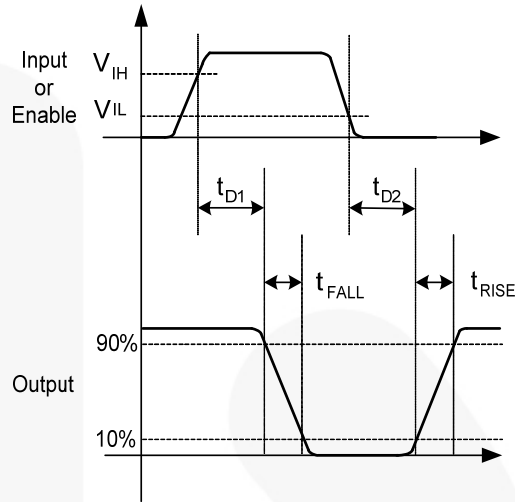

Figure 9. Inverting

Typical Performance Characteristics

Typical characteristics are provided at 25°C and $V_{DD}=12\text{ V}$ unless otherwise noted.

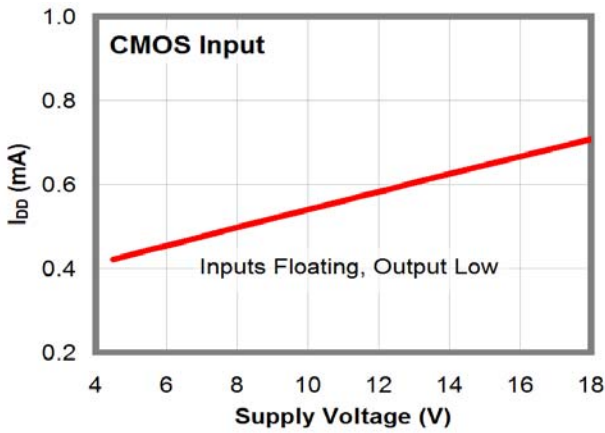

Figure 10. I_{DD} (Static) vs. Supply Voltage⁽¹⁴⁾

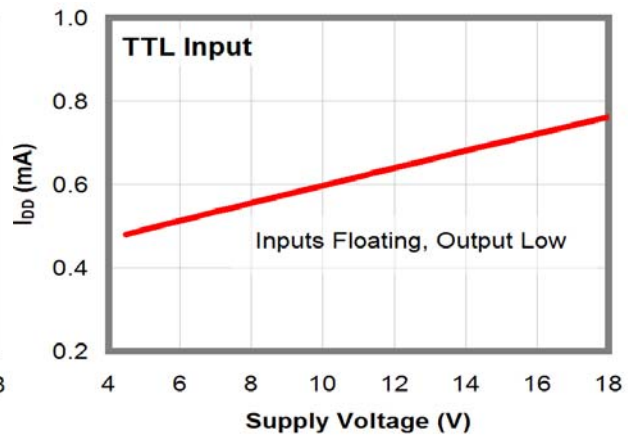

Figure 11. I_{DD} (Static) vs. Supply Voltage⁽¹⁴⁾

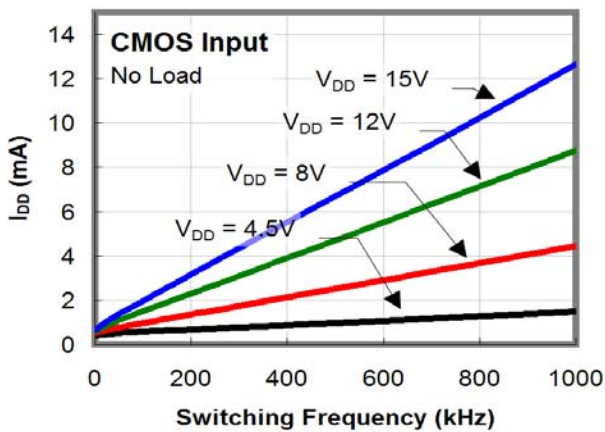

Figure 12. I_{DD} (No-Load) vs. Frequency

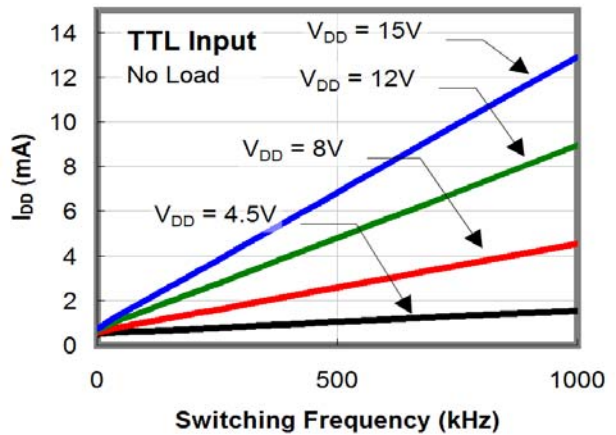

Figure 13. I_{DD} (No-Load) vs. Frequency

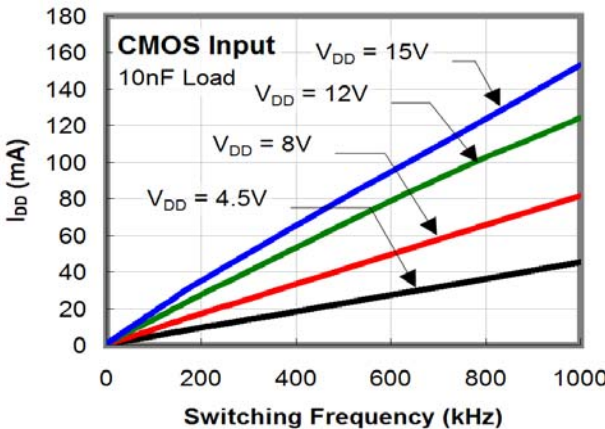

Figure 14. I_{DD} (10 nF Load) vs. Frequency

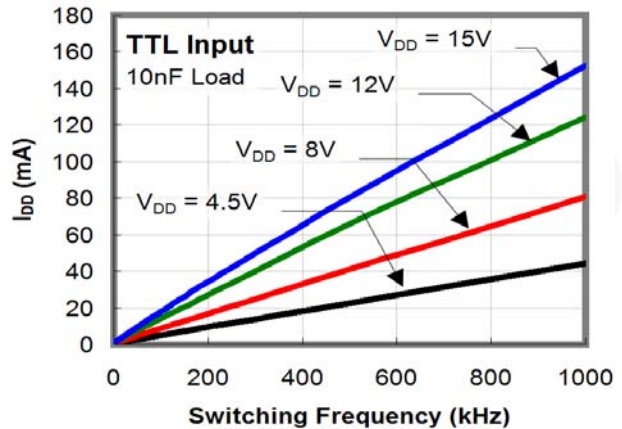

Figure 15. I_{DD} (10 nF Load) vs. Frequency

Typical Performance Characteristics

Typical characteristics are provided at 25°C and $V_{DD}=12\text{ V}$ unless otherwise noted.

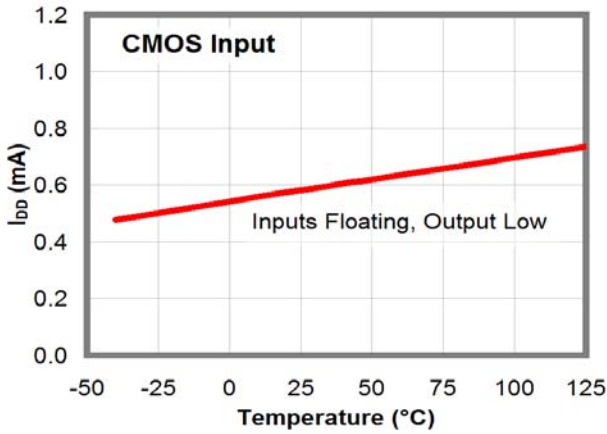

Figure 16. I_{DD} (Static) vs. Temperature⁽¹⁴⁾

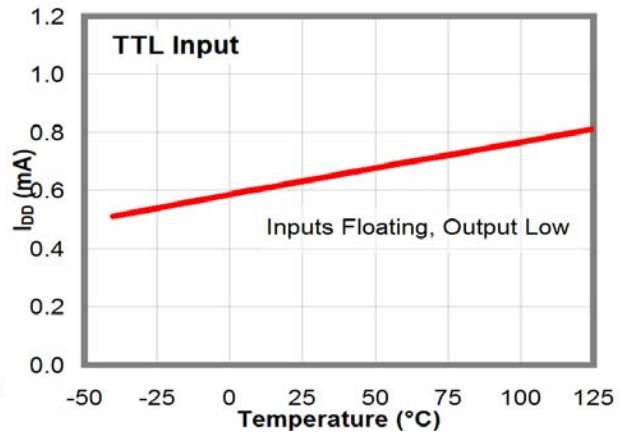

Figure 17. I_{DD} (Static) vs. Temperature⁽¹⁴⁾

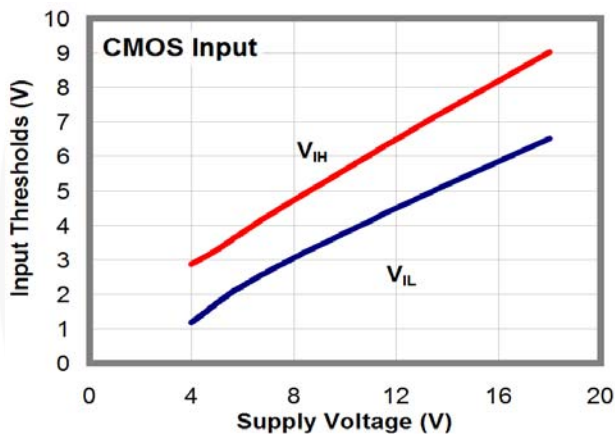

Figure 18. Input Thresholds vs. Supply Voltage

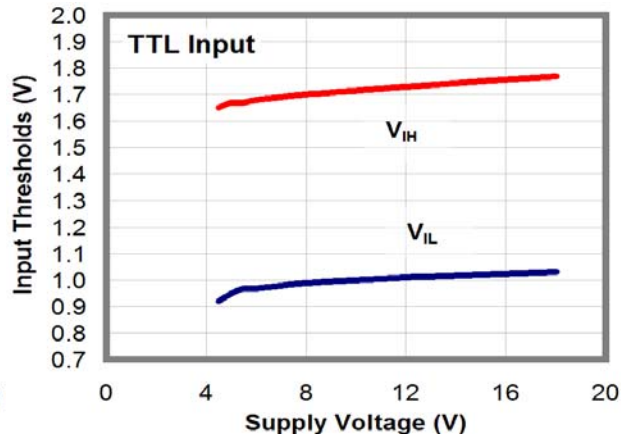

Figure 19. Input Thresholds vs. Supply Voltage

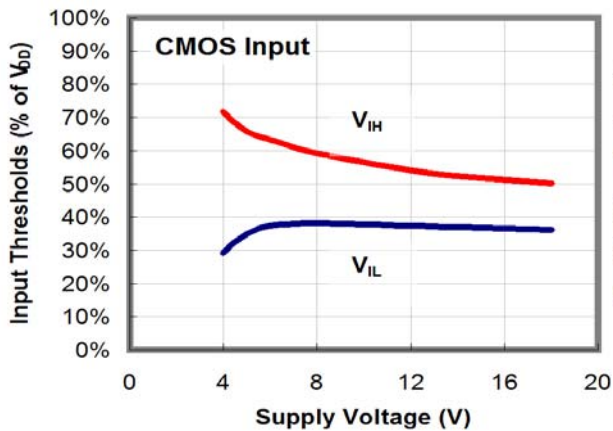

Figure 20. Input Thresholds % vs. Supply Voltage

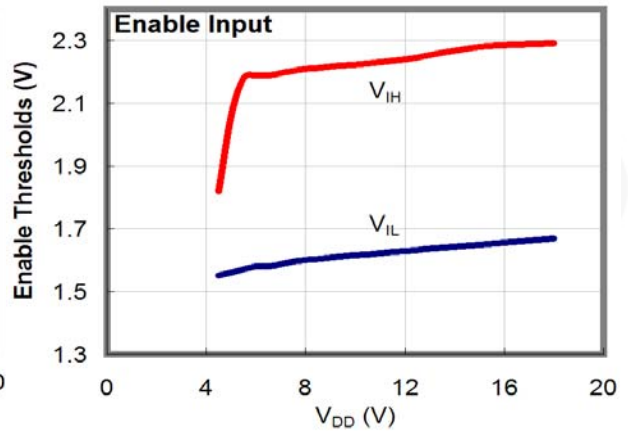

Figure 21. Enable Thresholds vs. Supply Voltage

Typical Performance Characteristics

Typical characteristics are provided at 25°C and $V_{DD}=12\text{ V}$ unless otherwise noted.

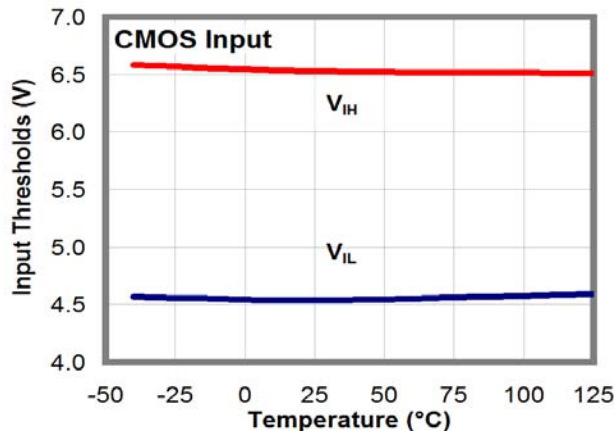

Figure 22. CMOS Input Thresholds vs. Temperature

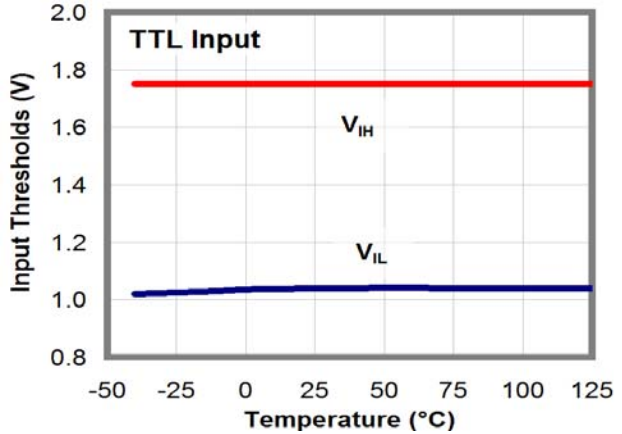

Figure 23. TTL Input Thresholds vs. Temperature

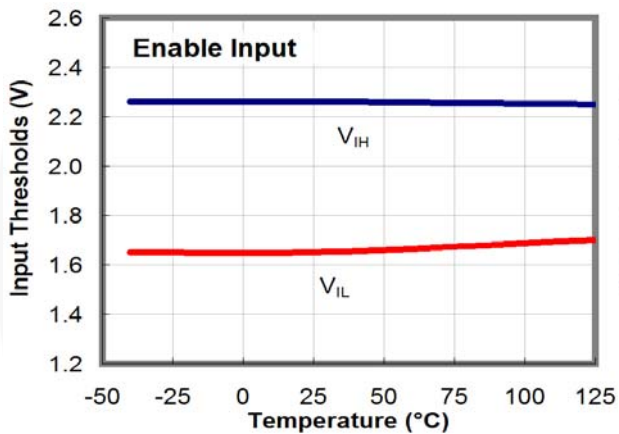

Figure 24. Enable Thresholds vs. Temperature

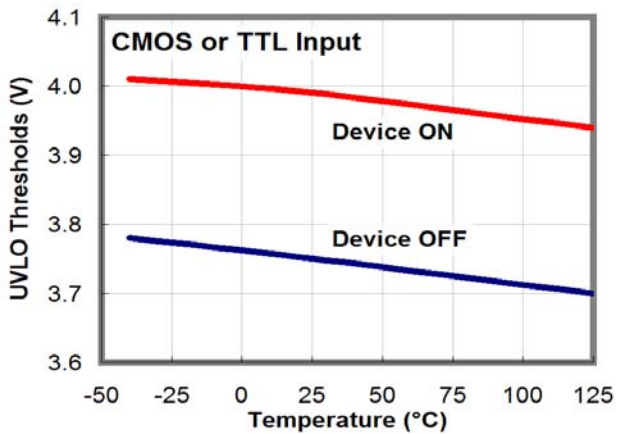

Figure 25. UVLO Thresholds vs. Temperature

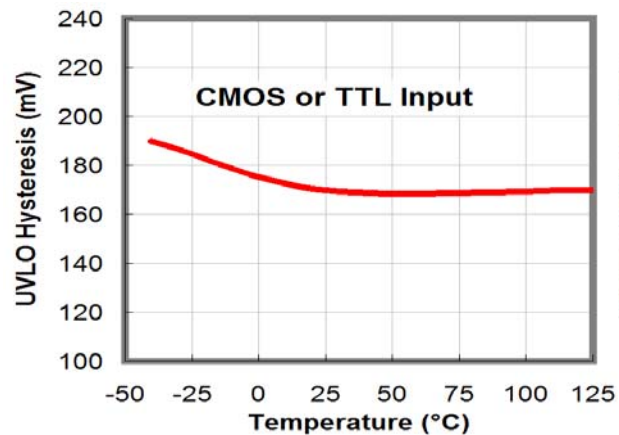

Figure 26. UVLO Hysteresis vs. Temperature

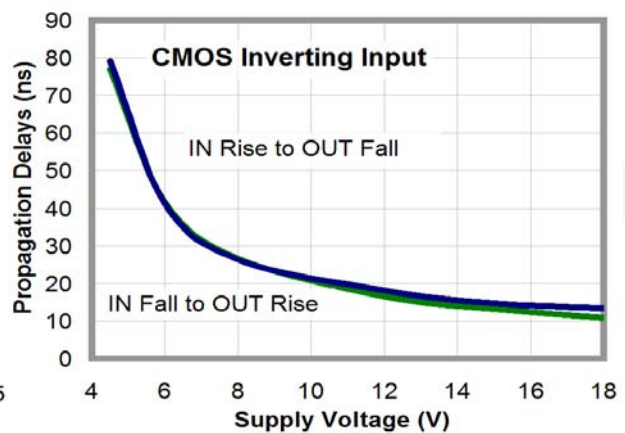

Figure 27. Propagation Delay vs. Supply Voltage

Typical Performance Characteristics

Typical characteristics are provided at 25°C and $V_{DD}=12\text{ V}$ unless otherwise noted.

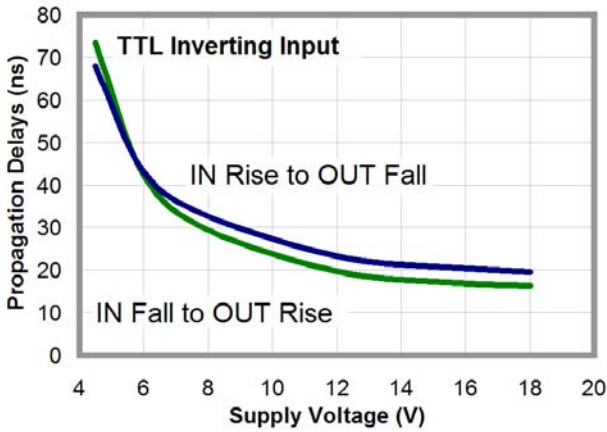

Figure 28. Propagation Delay vs. Supply Voltage

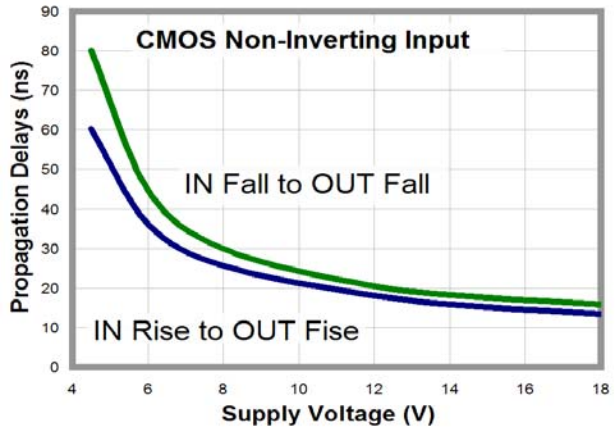

Figure 29. Propagation Delay vs. Supply Voltage

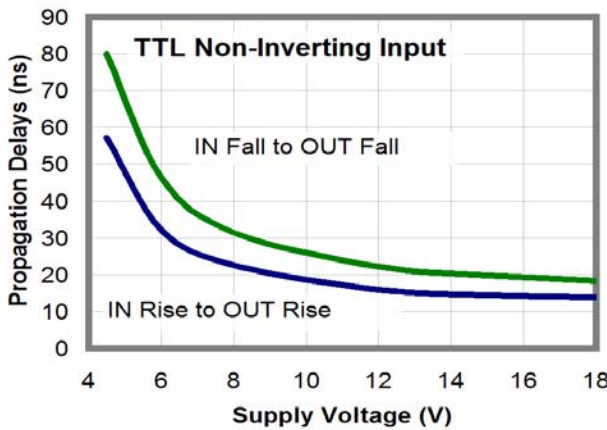

Figure 30. Propagation Delay vs. Supply Voltage

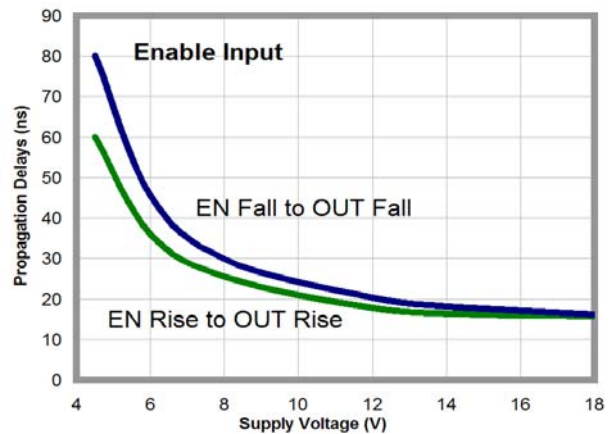

Figure 31. Propagation Delay vs. Supply Voltage

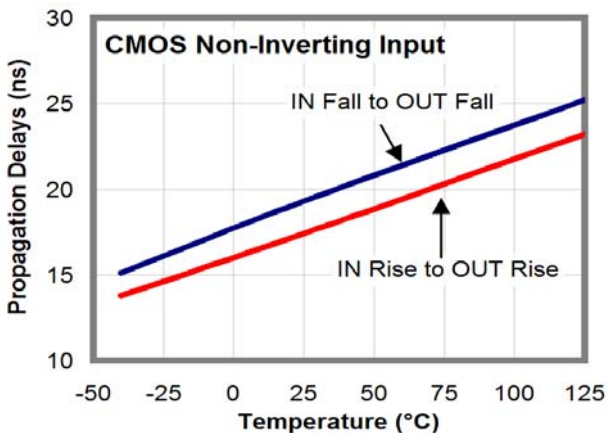

Figure 32. Propagation Delays vs. Temperature

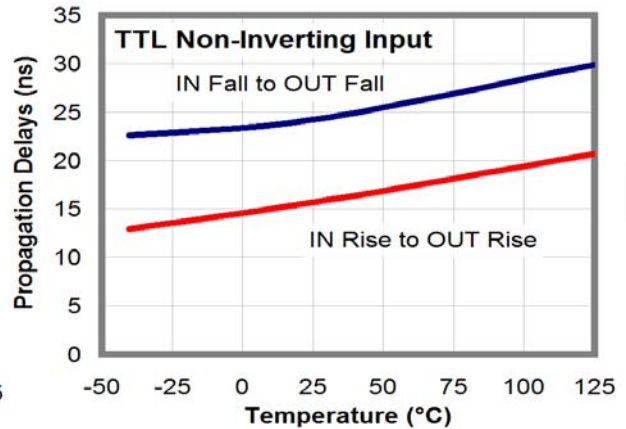

Figure 33. Propagation Delays vs. Temperature

Typical Performance Characteristics

Typical characteristics are provided at 25°C and $V_{DD}=12\text{ V}$ unless otherwise noted.

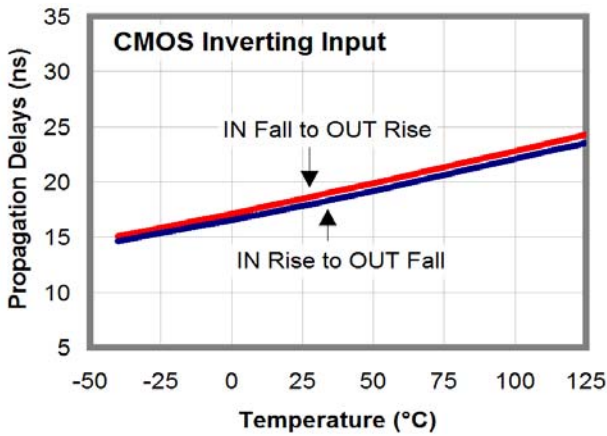

Figure 34. Propagation Delays vs. Temperature

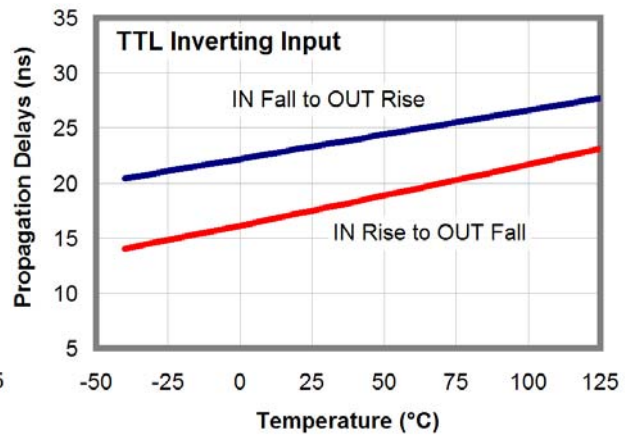

Figure 35. Propagation Delays vs. Temperature

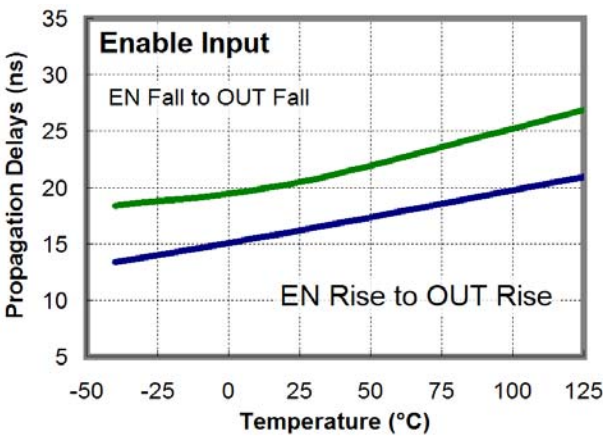

Figure 36. Propagation Delays vs. Temperature

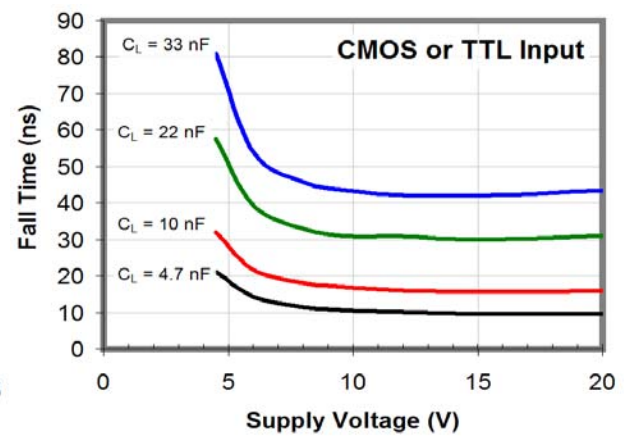

Figure 37. Fall Time vs. Supply Voltage

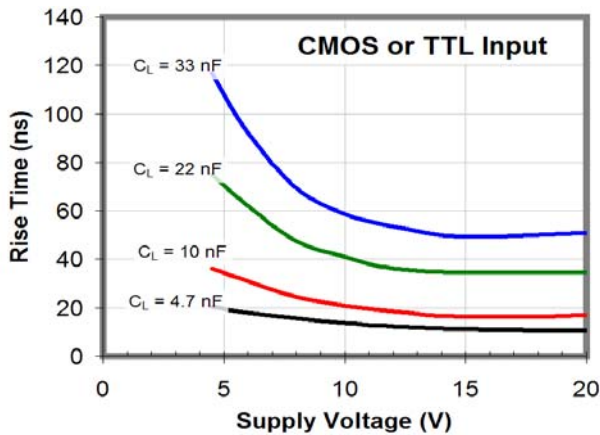

Figure 38. Rise Time vs. Supply Voltage

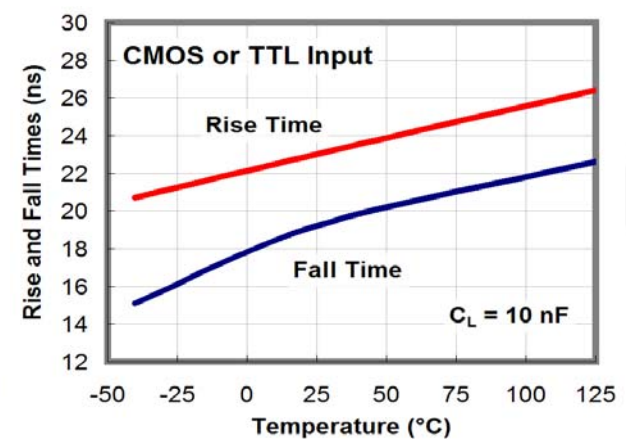

Figure 39. Rise and Fall Time vs. Temperature

Typical Performance Characteristics

Typical characteristics are provided at 25°C and $V_{DD}=12\text{ V}$ unless otherwise noted.

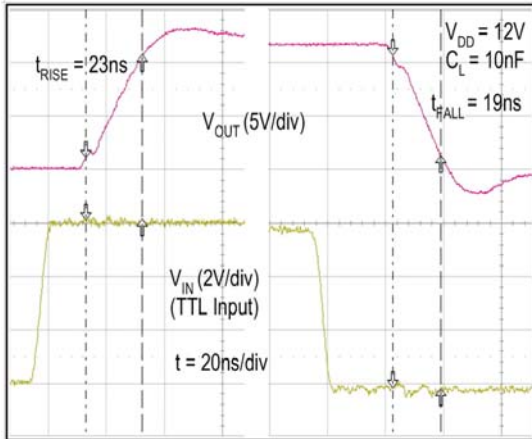

Figure 40. Rise / Fall Waveforms with 10 nF Load

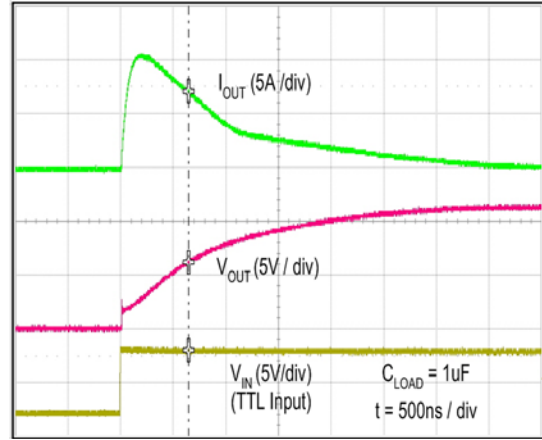

Figure 41. Quasi-Static Source Current with $V_{DD}=12\text{V}$ ⁽¹⁵⁾

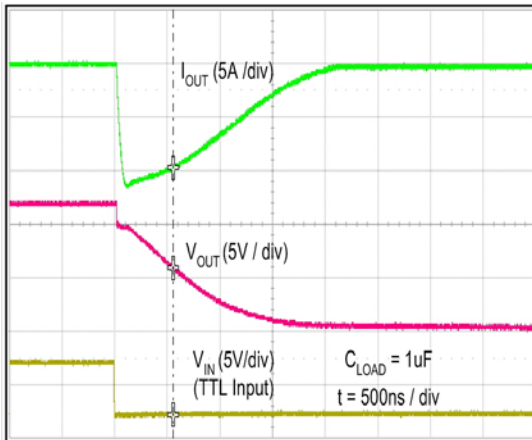

Figure 42. Quasi-Static Sink Current with $V_{DD}=12\text{ V}$ ⁽¹⁵⁾

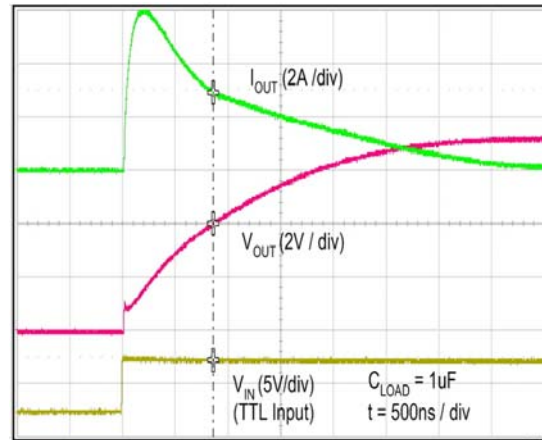

Figure 43. Quasi-Static Source Current with $V_{DD}=8\text{ V}$ ⁽¹⁵⁾

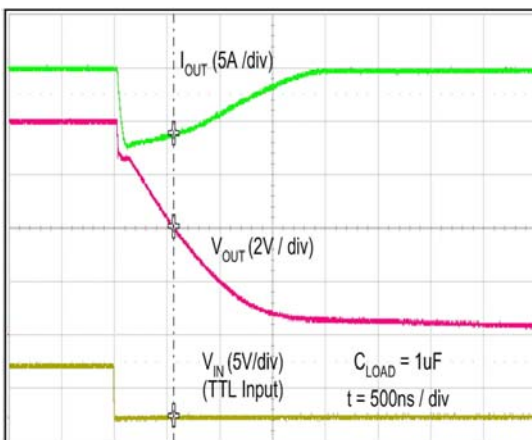

Figure 44. Quasi-Static Sink Current with $V_{DD}=8\text{ V}$ ⁽¹⁵⁾

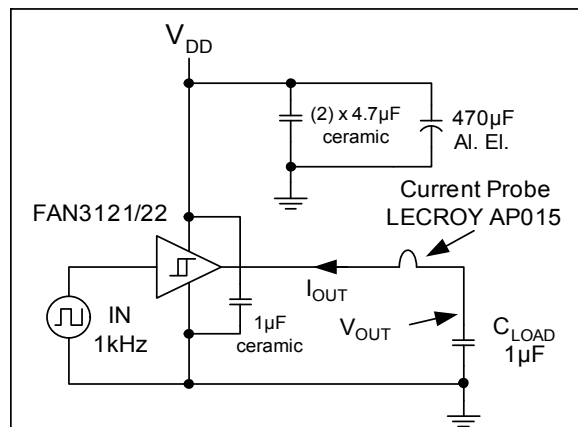

Figure 45. Quasi-Static I_{OUT} / V_{OUT} Test Circuit

Notes:

14. For any inverting inputs pulled LOW, non-inverting inputs pulled HIGH, or outputs driven HIGH; static I_{DD} increases by the current flowing through the corresponding pull-up/down resistor, shown in Figure 7.
15. The initial spike in each current waveform is a measurement artifact caused by the stray inductance of the current-measurement loop.

Applications Information

The FAN3121 and FAN3122 family offers versions in either TTL or CMOS input configuration. In the FAN3121T and FAN3122T, the input thresholds meet industry-standard TTL-logic thresholds independent of the V_{DD} voltage, and there is a hysteresis voltage of approximately 0.7 V. These levels permit the inputs to be driven from a range of input logic signal levels for which a voltage over 2 V is considered logic HIGH. The driving signal for the TTL inputs should have fast rising and falling edges with a slew rate of 6 V/ μ s or faster, so the rise time from 0 to 3.3 V should be 550 ns or less.

The FAN3121 and FAN3122 output can be enabled or disabled using the EN pin with a very rapid response time. If EN is not externally connected, an internal pull-up resistor enables the driver by default. The EN pin has logic thresholds for parts with either TTL or CMOS IN thresholds.

In the FAN3121C and FAN3122C, the logic input thresholds are dependent on the V_{DD} level and, with V_{DD} of 12 V, the logic rising edge threshold is approximately 55% of V_{DD} and the input falling edge threshold is approximately 38% of V_{DD} . The CMOS input configuration offers a hysteresis voltage of approximately 17% of V_{DD} . The CMOS inputs can be used with relatively slow edges (approaching DC) if good decoupling and bypass techniques are incorporated in the system design to prevent noise from violating the input voltage hysteresis window. This allows setting precise timing intervals by fitting an R-C circuit between the controlling signal and the IN pin of the driver. The slow rising edge at the IN pin of the driver introduces a delay between the controlling signal and the OUT pin of the driver.

Static Supply Current

In the I_{DD} (static) Typical Performance Characteristics, the curves are produced with all inputs / enables floating (OUT is LOW) and indicates the lowest static I_{DD} current for the tested configuration. For other states, additional current flows through the 100 k Ω resistors on the inputs and outputs, as shown in the block diagram (see Figure 7). In these cases, the actual static I_{DD} current is the value obtained from the curves, plus this additional current.

MillerDrive™ Gate-Drive Technology

FAN312x gate drivers incorporate the MillerDrive™ architecture shown in Figure 46. For the output stage, a combination of bipolar and MOS devices provide large currents over a wide range of supply voltage and temperature variations. The bipolar devices carry the bulk of the current as OUT swings between 1/3 to 2/3 V_{DD} and the MOS devices pull the output to the HIGH or LOW rail.

The purpose of the Miller Drive™ architecture is to speed up switching by providing high current during the Miller plateau region when the gate-drain capacitance of the MOSFET is being charged or discharged as part of the turn-on / turn-off process.

For applications with zero voltage switching during the MOSFET turn-on or turn-off interval, the driver supplies high peak current for fast switching, even though the Miller plateau is not present. This situation often occurs in synchronous rectifier applications because the body diode is generally conducting before the MOSFET is switched on.

The output pin slew rate is determined by V_{DD} voltage and the load on the output. It is not user adjustable, but a series resistor can be added if a slower rise or fall time at the MOSFET gate is needed.

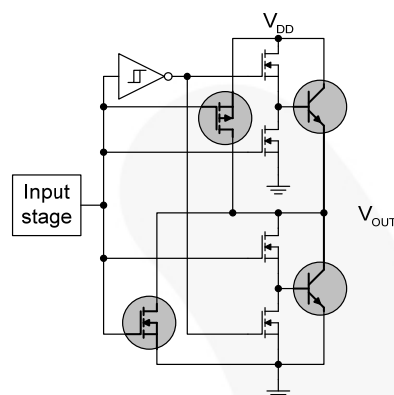

Figure 46. Miller Drive™ Output Architecture

Under-Voltage Lockout (UVLO)

The FAN312x startup logic is optimized to drive ground-referenced N-channel MOSFETs with an under-voltage lockout (UVLO) function to ensure that the IC starts in an orderly fashion. When V_{DD} is rising, yet below the 4.0 V operational level, this circuit holds the output low, regardless of the status of the input pins. After the part is active, the supply voltage must drop 0.25 V before the part shuts down. This hysteresis helps prevent chatter when low V_{DD} supply voltages have noise from the power switching. This configuration is not suitable for driving high-side P-channel MOSFETs because the low output voltage of the driver would turn the P-channel MOSFET on with V_{DD} below 4.0 V.

V_{DD} Bypassing and Layout Considerations

The FAN3121 and FAN3122 are available in either 8-lead SOIC or MLP packages. In either package, the V_{DD} pins 1 and 8 and the GND pins 4 and 5 should be connected together on the PCB.

In typical FAN312x gate-driver applications, high-current pulses are needed to charge and discharge the gate of a power MOSFET in time intervals of 50 ns or less. A bypass capacitor with low ESR and ESL should be connected directly between the V_{DD} and GND pins to provide these large current pulses without causing unacceptable ripple on the V_{DD} supply. To meet these requirements in a small size, a ceramic capacitor of 1 μ F or larger is typically used, with a dielectric material such as X7R, to limit the change in capacitance over the temperature and / or voltage application ranges.

Figure 47 shows the pulsed gate drive current path when the gate driver is supplying gate charge to turn the MOSFET on. The current is supplied from the local bypass capacitor C_{BYP} and flows through the driver to the MOSFET gate and to ground. To reach the high peak currents possible with the FAN312x family, the resistance and inductance in the path should be minimized. The localized C_{BYP} acts to contain the high peak current pulses within this driver-MOSFET circuit, preventing them from disturbing the sensitive analog circuitry in the PWM controller.

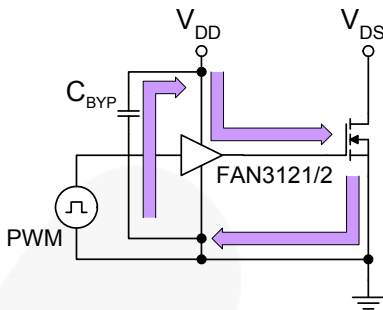

Figure 47. Current Path for MOSFET Turn-On

Figure 48 shows the path the current takes when the gate driver turns the MOSFET off. Ideally, the driver shunts the current directly to the source of the MOSFET in a small circuit loop. For fast turn-off times, the resistance and inductance in this path should be minimized.

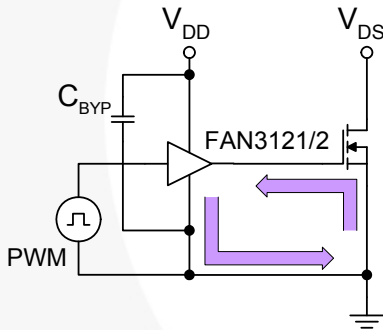

Figure 48. Current Path for MOSFET Turn-Off

Operational Waveforms

At power up, the FAN3121 inverting driver shown in Figure 49 holds the output LOW until the V_{DD} voltage reaches the UVLO turn-on threshold, as indicated in Figure 50. This facilitates proper startup control of low-side N-channel MOSFETs.

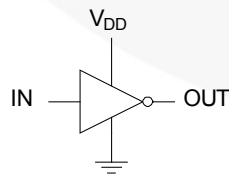

Figure 49. Inverting Configuration

The OUT pulses' magnitude follows V_{DD} magnitude with the output polarity inverted from the input until steady-state V_{DD} is reached.

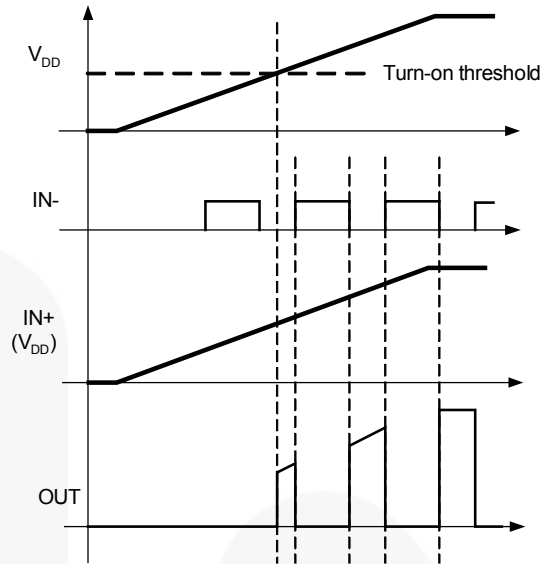

Figure 50. Inverting Startup Waveforms

At power up, the FAN3122 non-inverting driver, shown in Figure 51, holds the output LOW until the V_{DD} voltage reaches the UVLO turn-on threshold, as indicated in Figure 52. The OUT pulses magnitude follow V_{DD} magnitude until steady-state V_{DD} is reached.

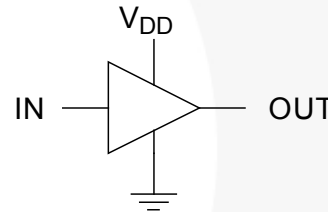

Figure 51. Non-Inverting Driver

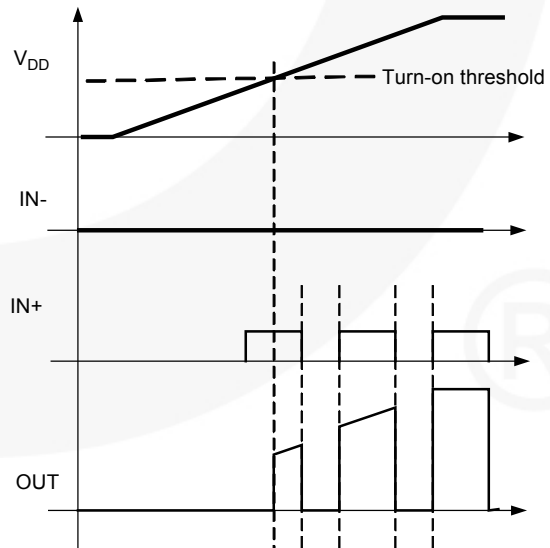

Figure 52. Non-Inverting Startup Waveforms

Thermal Guidelines

Gate drivers used to switch MOSFETs and IGBTs at high frequencies can dissipate significant amounts of power. It is important to determine the driver power dissipation and the resulting junction temperature in the application to ensure that the part is operating within acceptable temperature limits.

The total power dissipation in a gate driver is the sum of two components, P_{GATE} and $P_{DYNAMIC}$:

$$P_{TOTAL} = P_{GATE} + P_{DYNAMIC} \quad (1)$$

Gate Driving Loss: The most significant power loss results from supplying gate current (charge per unit time) to switch the load MOSFET on and off at the switching frequency. The power dissipation that results from driving a MOSFET at a specified gate-source voltage, V_{GS} , with gate charge, Q_G , at switching frequency, f_{SW} , is determined by:

$$P_{GATE} = Q_G \cdot V_{GS} \cdot f_{SW} \quad (2)$$

Dynamic Pre-drive / Shoot-through Current: A power loss resulting from internal current consumption under dynamic operating conditions, including pin pull-up / pull-down resistors, can be obtained using the "IDD (No-Load) vs. Frequency" graphs in Typical Performance Characteristics to determine the current $I_{DYNAMIC}$ drawn from V_{DD} under actual operating conditions:

$$P_{DYNAMIC} = I_{DYNAMIC} \cdot V_{DD} \quad (3)$$

Once the power dissipated in the driver is determined, the driver junction rise with respect to circuit board can be evaluated using the following thermal equation, assuming Ψ_{JB} was determined for a similar thermal design (heat sinking and air flow):

$$T_J = P_{TOTAL} \cdot \Psi_{JB} + T_B \quad (4)$$

where:

T_J = driver junction temperature;

Ψ_{JB} = (psi) thermal characterization parameter relating temperature rise to total power dissipation; and

T_B = board temperature in location as defined in the Thermal Characteristics table.

In a full-bridge synchronous rectifier application, shown in Figure 53, each FAN3122 drives a parallel combination of two high-current MOSFETs, (such as FDMS8660S). The typical gate charge for each SR MOSFET is 70 nC with $V_{GS} = V_{DD} = 9$ V. At a switching frequency of 300 kHz, the total power dissipation is:

$$P_{GATE} = 2 \cdot 70 \text{ nC} \cdot 9 \text{ V} \cdot 300 \text{ kHz} = 0.378 \text{ W} \quad (5)$$

$$P_{DYNAMIC} = 2 \text{ mA} \cdot 9 \text{ V} = 18 \text{ mW} \quad (6)$$

$$P_{TOTAL} = 0.396 \text{ W} \quad (7)$$

The SOIC-8 has a junction-to-board thermal characterization parameter of $\Psi_{JB} = 42^\circ\text{C/W}$. In a system application, the localized temperature around the device is a function of the layout and construction of the PCB along with airflow across the surfaces. To ensure reliable operation, the maximum junction temperature of the device must be prevented from exceeding the maximum rating of 150°C ; with 80% derating, T_J would be limited to 120°C . Rearranging Equation 4 determines the board temperature required to maintain the junction temperature below 120°C :

$$T_{B,MAX} = T_J - P_{TOTAL} \cdot \Psi_{JB} \quad (8)$$

$$T_{B,MAX} = 120^\circ\text{C} - 0.396 \text{ W} \cdot 42^\circ\text{C/W} = 104^\circ\text{C} \quad (9)$$

For comparison, replace the SOIC-8 used in the previous example with the 3x3 mm MLP package with $\Psi_{JB} = 2.8^\circ\text{C/W}$. The 3x3 mm MLP package can operate at a PCB temperature of 118°C , while maintaining the junction temperature below 120°C . This illustrates that the physically smaller MLP package with thermal pad offers a more conductive path to remove the heat from the driver. Consider tradeoffs between reducing overall circuit size with junction temperature reduction for increased reliability.

Typical Application Diagrams

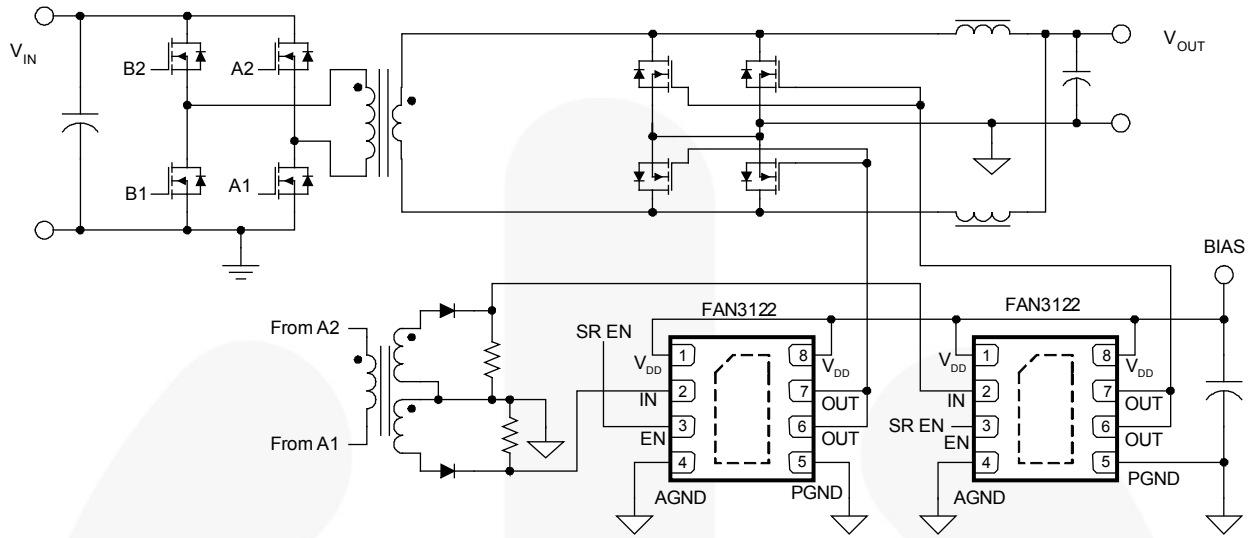

Figure 53. Full-Bridge Synchronous Rectification

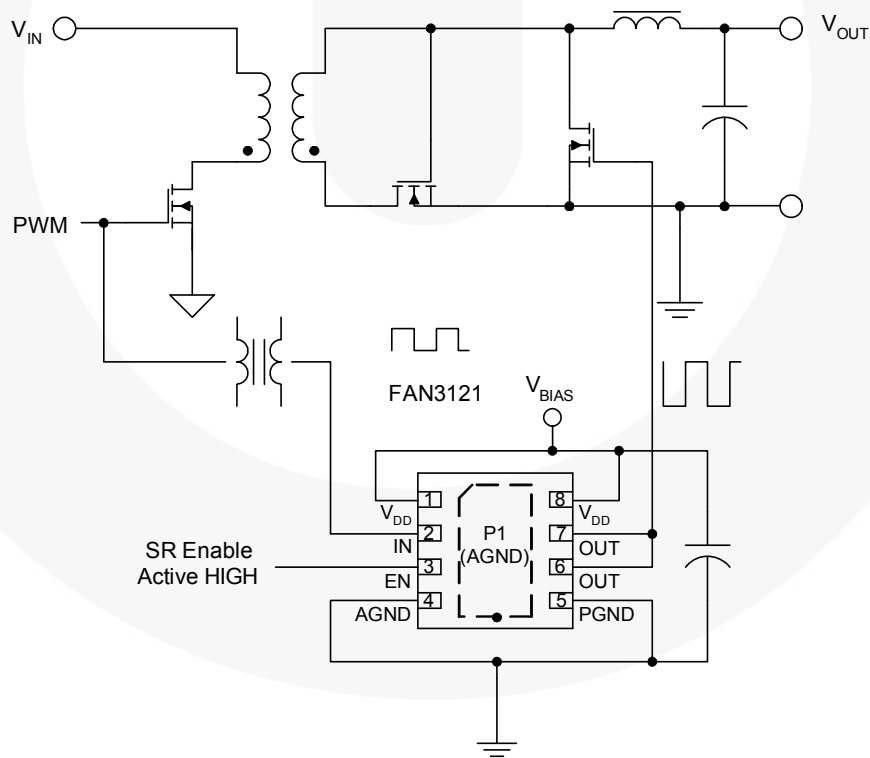

Figure 54. Hybrid Synchronous Rectification in a Forward Converter

Table 1. Related Products

| Part Number | Type | Gate Drive ⁽¹⁶⁾ (Sink/Src) | Input Threshold | Logic | Package ⁽¹⁸⁾ |
|-----------------|-------------------|--|--------------------------|---|-------------------------|
| FAN3111C | Single 1 A | +1.1 A / -0.9 A | CMOS | Single Channel of Dual-Input/Single-Output | SOT23-5, MLP6 |
| FAN3111E | Single 1 A | +1.1 A / -0.9 A | External ⁽¹⁷⁾ | Single Non-Inverting Channel with External Reference | SOT23-5, MLP6 |
| FAN3100C | Single 2 A | +2.5 A / -1.8 A | CMOS | Single Channel of Two-Input/One-Output | SOT23-5, MLP6 |
| FAN3100T | Single 2 A | +2.5 A / -1.8 A | TTL | Single Channel of Two-Input/One-Output | SOT23-5, MLP6 |
| FAN3180 | Single 2 A | +2.4 A / -1.6 A | TTL | Single Non-Inverting Channel + 3.3 V LDO | SOT23-5 |
| FAN3216T | Dual 2 A | +2.4 A / -1.6 A | TTL | Dual Inverting Channels | SOIC8 |
| FAN3217T | Dual 2 A | +2.4 A / -1.6 A | TTL | Dual Non-Inverting Channels | SOIC8 |
| FAN3226C | Dual 2 A | +2.4 A / -1.6 A | CMOS | Dual Inverting Channels + Dual Enable | SOIC8, MLP8 |
| FAN3226T | Dual 2 A | +2.4 A / -1.6 A | TTL | Dual Inverting Channels + Dual Enable | SOIC8, MLP8 |
| FAN3227C | Dual 2 A | +2.4 A / -1.6 A | CMOS | Dual Non-Inverting Channels + Dual Enable | SOIC8, MLP8 |
| FAN3227T | Dual 2 A | +2.4 A / -1.6 A | TTL | Dual Non-Inverting Channels + Dual Enable | SOIC8, MLP8 |
| FAN3228C | Dual 2 A | +2.4 A / -1.6 A | CMOS | Dual Channels of Two-Input/One-Output | SOIC8, MLP8 |
| FAN3228T | Dual 2A | +2.4 A / -1.6 A | TTL | Dual Channels of Two-Input/One-Output | SOIC8, MLP8 |
| FAN3229C | Dual 2 A | +2.4 A / -1.6 A | CMOS | Dual Channels of Two-Input/One-Output | SOIC8, MLP8 |
| FAN3229T | Dual 2 A | +2.4 A / -1.6 A | TTL | Dual Channels of Two-Input/One-Output | SOIC8, MLP8 |
| FAN3268T | Dual 2 A | +2.4 A / -1.6 A | TTL | 20 V Non-Inverting Channel (NMOS) and Inverting Channel (PMOS) + Dual Enables | SOIC8 |
| FAN3278T | Dual 2 A | +2.4 A / -1.6 A | TTL | 30 V Non-Inverting Channel (NMOS) and Inverting Channel (PMOS) + Dual Enables | SOIC8 |
| FAN3223C | Dual 4 A | +4.3 A / -2.8 A | CMOS | Dual Inverting Channels + Dual Enable | SOIC8, MLP8 |
| FAN3213T | Dual 4 A | +4.3 A / -2.8 A | TTL | Dual Inverting Channels | SOIC8 |
| FAN3214T | Dual 4 A | +4.3 A / -2.8 A | TTL | Dual Non-Inverting Channels | SOIC8 |
| FAN3223T | Dual 4 A | +4.3 A / -2.8 A | TTL | Dual Inverting Channels + Dual Enable | SOIC8, MLP8 |
| FAN3224C | Dual 4 A | +4.3 A / -2.8 A | CMOS | Dual Non-Inverting Channels + Dual Enable | SOIC8, MLP8 |
| FAN3224T | Dual 4 A | +4.3 A / -2.8 A | TTL | Dual Non-Inverting Channels + Dual Enable | SOIC8, MLP8 |
| FAN3225C | Dual 4 A | +4.3 A / -2.8 A | CMOS | Dual Channels of Two-Input/One-Output | SOIC8, MLP8 |
| FAN3225T | Dual 4 A | +4.3 A / -2.8 A | TTL | Dual Channels of Two-Input/One-Output | SOIC8, MLP8 |
| FAN3121C | Single 9 A | +9.7 A / -7.1 A | CMOS | Single Inverting Channel + Enable | SOIC8, MLP8 |
| FAN3121T | Single 9 A | +9.7 A / -7.1 A | TTL | Single Inverting Channel + Enable | SOIC8, MLP8 |
| FAN3122C | Single 9 A | +9.7 A / -7.1 A | CMOS | Single Non-Inverting Channel + Enable | SOIC8, MLP8 |
| FAN3122T | Single 9 A | +9.7 A / -7.1 A | TTL | Single Non-Inverting Channel + Enable | SOIC8, MLP8 |
| FAN3240 | Dual 12 A | > +12.0 A | TTL | Dual-Coil Relay Driver, Timing Config. 0 | SOIC8 |
| FAN3241 | Dual 12 A | > +12.0 A | TTL | Dual-Coil Relay Driver, Timing Config. 1 | SOIC8 |

Notes:16. Typical currents with OUT at 6 V and $V_{DD} = 12$ V.

17. Thresholds proportional to an externally supplied reference voltage.

18. Automotive-qualified F085 versions are only offered in SOIC8 packages.

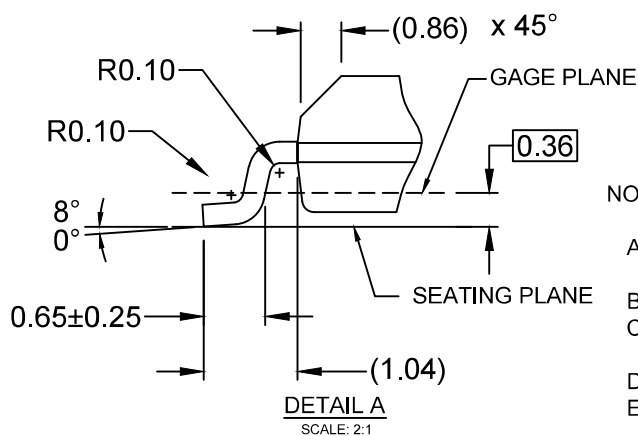
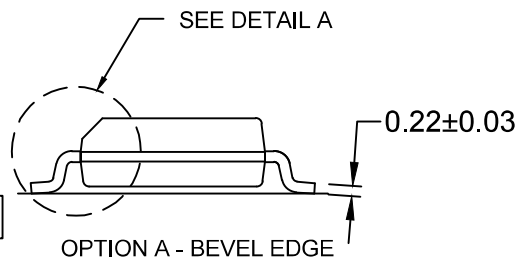
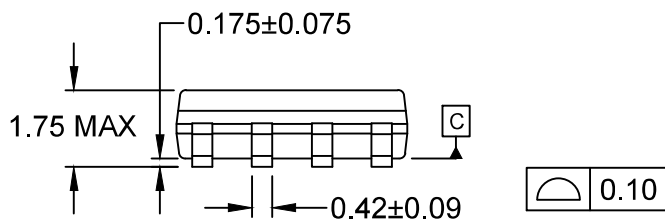
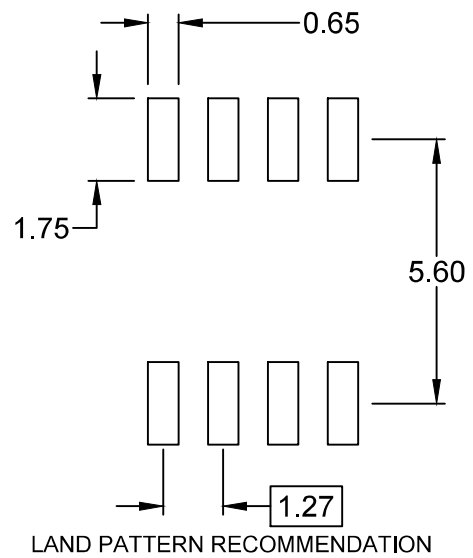
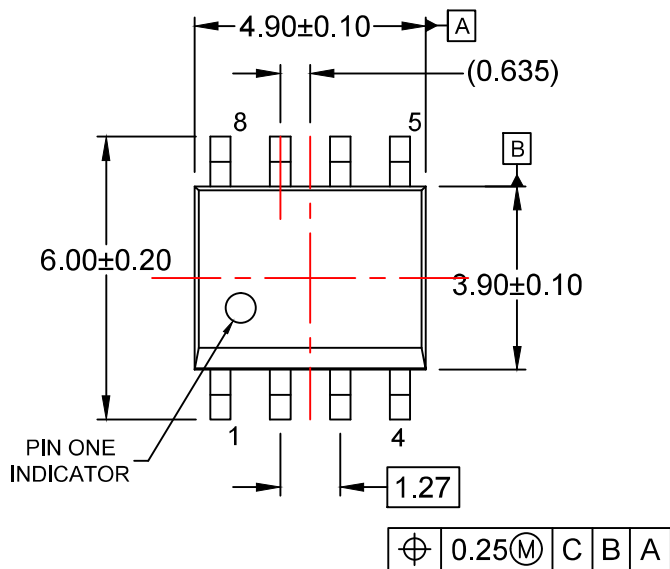

NOTES:

- A) THIS PACKAGE CONFORMS TO JEDEC MS-012, VARIATION AA.
- B) ALL DIMENSIONS ARE IN MILLIMETERS.
- C) DIMENSIONS DO NOT INCLUDE MOLD FLASH OR BURRS.
- D) LANDPATTERN STANDARD: SOIC127P600X175-8M
- E) DRAWING FILENAME: M08Arev16



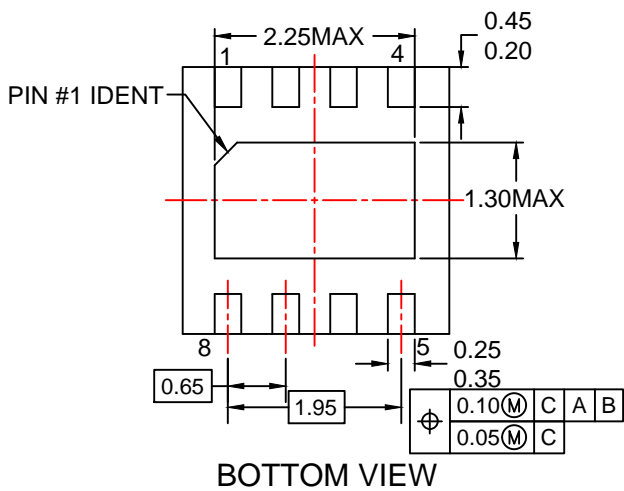
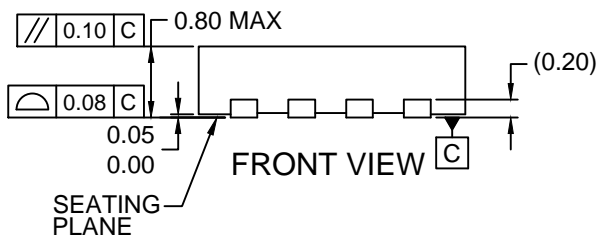
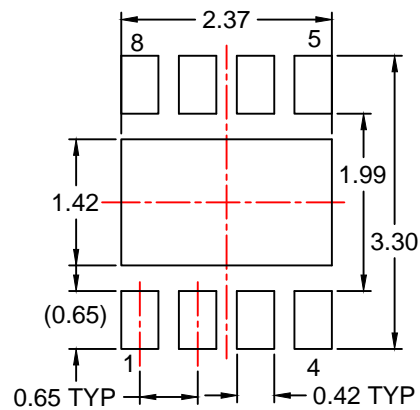
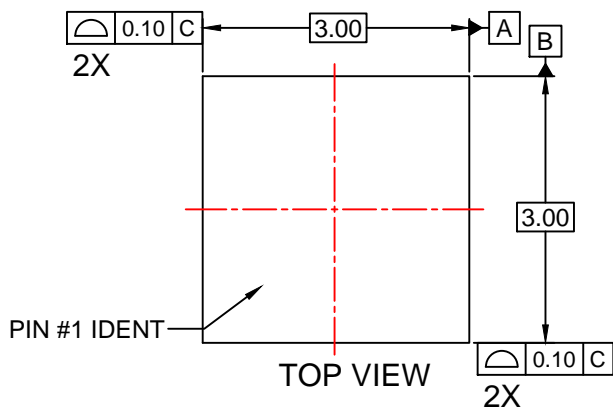

NOTES:

- A. CONFORMS TO JEDEC REGISTRATION MO-229, VARIATION VEEC, DATED 11/2001.
- B. DIMENSIONS ARE IN MILLIMETERS.
- C. DIMENSIONS AND TOLERANCES PER ASME Y14.5M, 2009.
- D. LAND PATTERN RECOMMENDATION IS EXISTING INDUSTRY LAND PATTERN.
- E. DRAWING FILENAME: MKT-MLP08Drev3



ON Semiconductor and  are trademarks of Semiconductor Components Industries, LLC dba ON Semiconductor or its subsidiaries in the United States and/or other countries. ON Semiconductor owns the rights to a number of patents, trademarks, copyrights, trade secrets, and other intellectual property. A listing of ON Semiconductor's product/patent coverage may be accessed at www.onsemi.com/site/pdf/Patent-Marking.pdf. ON Semiconductor reserves the right to make changes without further notice to any products herein. ON Semiconductor makes no warranty, representation or guarantee regarding the suitability of its products for any particular purpose, nor does ON Semiconductor assume any liability arising out of the application or use of any product or circuit, and specifically disclaims any and all liability, including without limitation special, consequential or incidental damages. Buyer is responsible for its products and applications using ON Semiconductor products, including compliance with all laws, regulations and safety requirements or standards, regardless of any support or applications information provided by ON Semiconductor. "Typical" parameters which may be provided in ON Semiconductor data sheets and/or specifications can and do vary in different applications and actual performance may vary over time. All operating parameters, including "Typicals" must be validated for each customer application by customer's technical experts. ON Semiconductor does not convey any license under its patent rights nor the rights of others. ON Semiconductor products are not designed, intended, or authorized for use as a critical component in life support systems or any FDA Class 3 medical devices or medical devices with a same or similar classification in a foreign jurisdiction or any devices intended for implantation in the human body. Should Buyer purchase or use ON Semiconductor products for any such unintended or unauthorized application, Buyer shall indemnify and hold ON Semiconductor and its officers, employees, subsidiaries, affiliates, and distributors harmless against all claims, costs, damages, and expenses, and reasonable attorney fees arising out of, directly or indirectly, any claim of personal injury or death associated with such unintended or unauthorized use, even if such claim alleges that ON Semiconductor was negligent regarding the design or manufacture of the part. ON Semiconductor is an Equal Opportunity/Affirmative Action Employer. This literature is subject to all applicable copyright laws and is not for resale in any manner.

PUBLICATION ORDERING INFORMATION

LITERATURE FULFILLMENT:

Literature Distribution Center for ON Semiconductor
19521 E. 32nd Pkwy, Aurora, Colorado 80011 USA
Phone: 303-675-2175 or 800-344-3860 Toll Free USA/Canada
Fax: 303-675-2176 or 800-344-3867 Toll Free USA/Canada
Email: orderlit@onsemi.com

N. American Technical Support: 800-282-9855 Toll Free
USA/Canada
Europe, Middle East and Africa Technical Support:
Phone: 421 33 790 2910
Japan Customer Focus Center
Phone: 81-3-5817-1050

ON Semiconductor Website: www.onsemi.com
Order Literature: <http://www.onsemi.com/orderlit>
For additional information, please contact your local
Sales Representative

Mouser Electronics

Authorized Distributor

Click to View Pricing, Inventory, Delivery & Lifecycle Information:

[ON Semiconductor:](#)

[FAN3122CMPX](#) [FAN3122CMX](#)