

PRODUCT NO.	PIN NUMBER						DIM "A"	PCB THICKNESS		PRODUCT NO.	PIN NUMBER						DIM "A"	PCB THICKNESS		PRODUCT NO.	PIN NUMBER						DIM "A"	PCB THICKNESS				
	ROW #	6	5	4	3	2					1	ROW #	6	5	4	3					2	1	ROW #	6	5	4				3	2	1
88949-X02 88949-X02LF	D	✓			✓		2.90	1.6		88949-X22LF	D					NO	2.90	1.6		88949-X32LF	D	✓				✓	2.90	1.6				
	C	✓			✓						C		✓			NO							C	NO						NO		
	B	✓			✓						B		✓			NO							B	NO						NO		
	A	✓			✓						A		✓			NO							A	✓						✓		
88949-X12 88949-X12LF	D	✓			✓		3.53	2.4																								
	C	✓			✓								✓																			
	B	✓			✓								✓																			
	A	✓			✓								✓																			

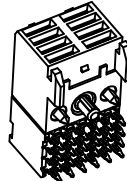

PLATING CONTACT AREA:	
DASH NR:	PERFORMANCE LEVEL
-1YY	TELCORDIA CO
-2YY	CUSTOMER SPECIAL
-3YY	CUSTOMER SPECIAL
-9YY	TELCORDIA CO
-1YYLF	TELCORDIA CO
-2YYLF	CUSTOMER SPECIAL
-3YYLF	CUSTOMER SPECIAL
-9YYLF	TELCORDIA CO

PRESS-FIT HOLES CHART	
HOLE DIAMETER AFTER PLATING	0.65-0.80
DRILLED HOLE	0.81-0.86
COPPER PLATING	0.025 MIN.
SnPb PLATING	0.005-0.015

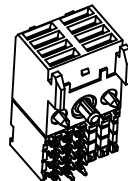
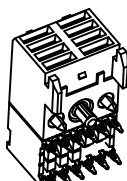
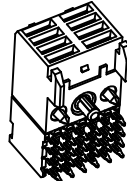
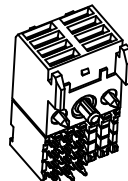
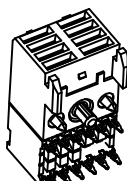
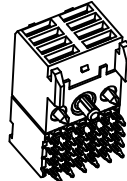
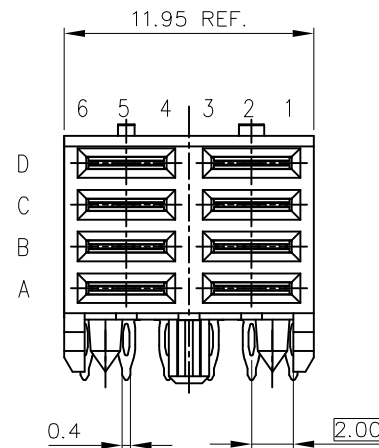
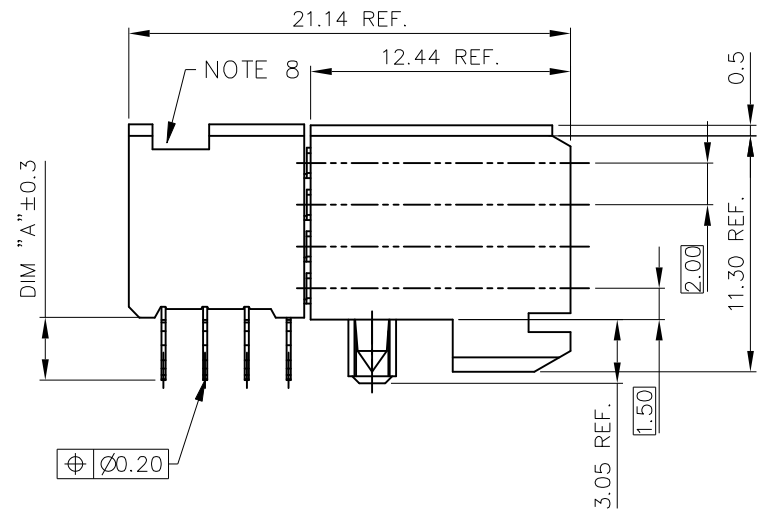
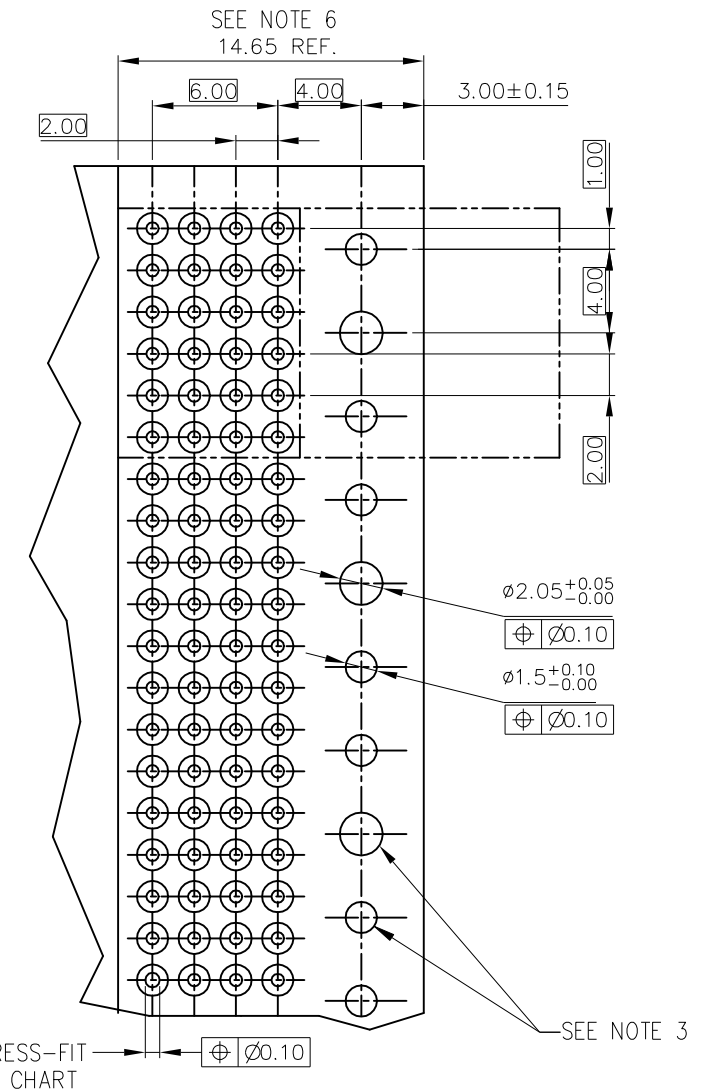

- NOTES:
- BODY MATERIAL: LIQUID CRYSTAL POLYMER 30% GLASS, FLAME RETARDANT ACC. UL 94-V0.
 - TERMINAL MATERIAL: PHOSPHOR BRONZE.
 - INDICATED HOLES ARE UNPLATED.
 - PLATING OF COMPLIANT SECTION 0.5-1.5 um SnPb 85-97 OR 0.5-1.5 um PURE Sn FOR LEAD FREE.
 - PRODUCT MARKING : PARTNUMBER & BATCH ID.
 - SET BACK FOR PRESS BLOCK.
 - SEE TA-941 FOR APPLICATION TOOLING.
 - TOP SURFACE OF PRESS BLOCK MAY EXTEND UP TO 0.4MM HIGHER THAN HOUSING. THIS MAY AFFECT THE TAIL LENGTH BEFORE APPLICATION TO A BOARD.
 - THIS PRODUCT MEETS EUROPEAN UNION DIRECTIVES AND OTHER COUNTRY REGULATIONS AS DESCRIBED IN GS-22-008 .
 - THE HOUSING WILL WITHSTAND EXPOSURE TO 260DEGREE PEAK TEMPERATURE FOR 10 SECONDS IN A WAVE SOLDER APPLICATION.
 - PRODUCT SPECIFICATION: GS-12-453.
 - APPLICATION SPECIFICATION: GS-20-001.
 - FOR THE PRODUCT WITH 30u" GOLD PLATING IN TERMINAL, THEY CAN BE REPLACED BY 30 GXT PLATING.

mat'l. code				surface ISO 1302 ✓		tolerance ISO 406/ISO 110		projection		product family METRAL(tm) HPL559		
ltr	ecn no	dr	date	tolerances unless otherwise specified		mm		title		R/A PRESS-FIT POWER RECEPTACLE ASSY.-12MM		
D	V61180	EPK	8/28/96	angles	.0±.3		scale 1:1		dwg no 88949 sheet1 of 1 size A4			
E	V00849	JWS	5/31/00	linear	.00±.13		Amphenol FCI		type Product Customer Drawing			
F	DG04-0107	CLu	041228	0°±2°	.000±.051							
G	DG07-0458	Cenh	11/15/07	dr	STU STONER	921029						
H	DG08-0171	TER	8/26/08	eng	R.DOUTRICH	921029						
J	EXL-N-23443	NICK	3/4/16	chr	STU STONER	921029						
K	ELX-N-26608	MZ	3/28/17	app	STU STONER	921029						
sheet index	revision	K										
	sheet	1										

Mouser Electronics

Authorized Distributor

Click to View Pricing, Inventory, Delivery & Lifecycle Information:

[FCI / Amphenol:](#)

[88949-102](#) [88949-202LF](#) [88949-202](#) [88949-112](#)