

2.4 GHz – 2.5 GHz FlexNotch 2 dBi Antenna w/U.FL Cable, 100mm



ORDERING INFORMATION

Order Number	Description
001-0015	2.4 GHz FlexNotch Antenna w/U.FL Cable, 100mm
001-0023	2.4GHz FlexNotch Antenna w/ MHF4L Cable, 100mm

Table 1 Orderable Part Numbers

KEY FEATURES

- Can be installed on flat or curved surfaces.
- Quick and easy Installation
- Adhesive holds to surface during humidity exposure and hot/cold cycles
- Simple custom options with trimming length.
- Flexible, ultra-low profile
- RoHS Compliant

The information in this document is subject to change without notice.

SPECIFICATIONS

Specification	Value
Peak Gain	+2 dBi
Average Gain	>-1.6 dBi
Impedance	50 ohms
Type	Flexible Notch
Polarization	Linear
VSWR	< 2.5:1, 2400 - 2480 MHz
Frequency	2400 – 2480 MHz
Weight	0.85g
Size	32.0mm × 21.08mm
Antenna Color	Clear Yellow
Adhesive	3M 100MP
Operating Temp	-40°C to +85°C
Connector Height	MHF1 (U.FL): 2.5mm Max
	MHF4L: 1.4mm Max

Table 2 Specifications

PHYSICAL DIMENSIONS (MM)

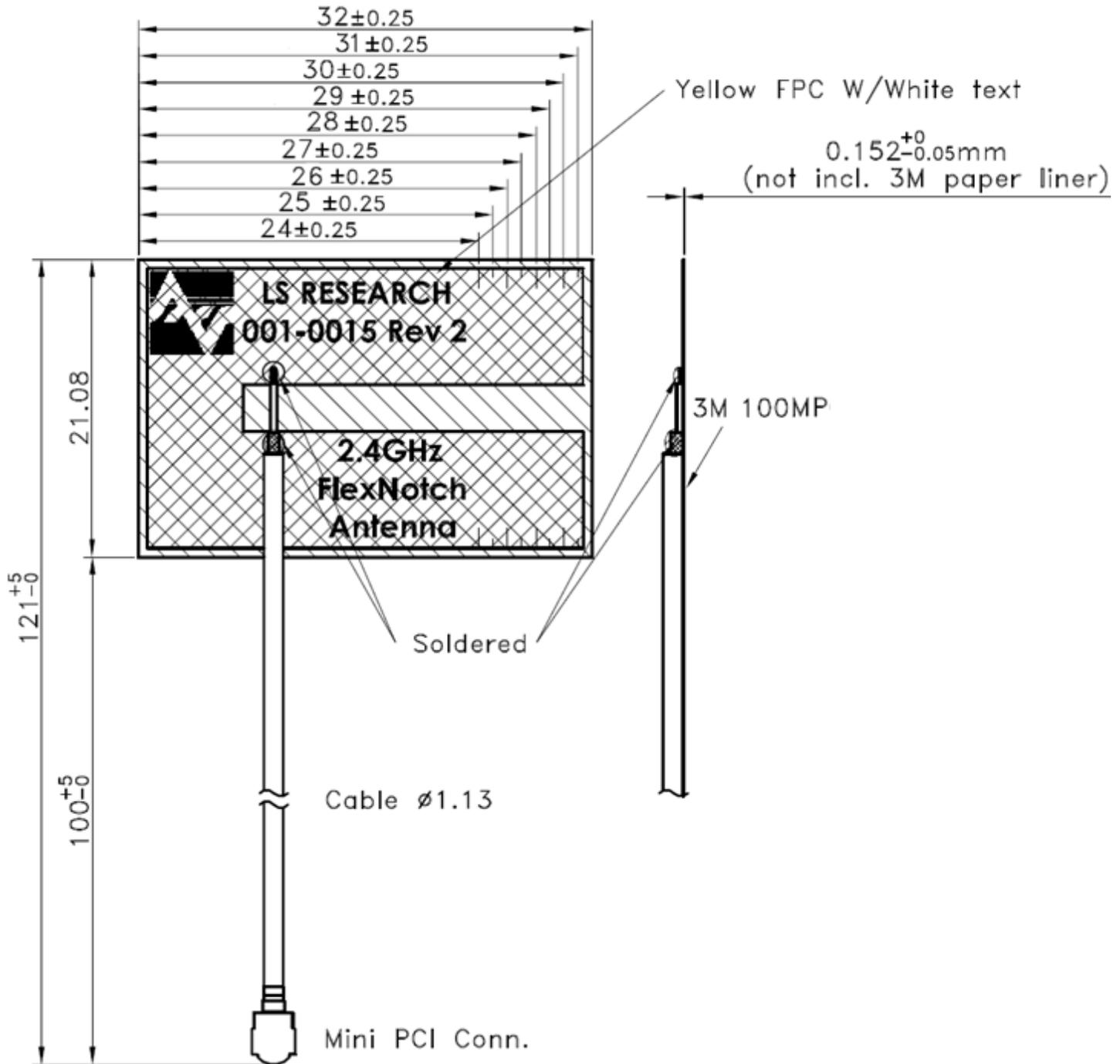

Figure 1 Physical Dimensions

TEST SETUP

Antenna measurements such as VSWR were measured with an Agilent E5071C Vector Network Analyzer. Radiation patterns were measured with an Agilent 5181A Signal Generator and Agilent E4445A Spectrum Analyzer in a 3-meter Anechoic Chamber.

Flat surface measurements were done with the antenna centered on a 1.5 mm thick plate of Polycarbonate.

FLAT SURFACE ANTENNA MEASUREMENTS

VSWR

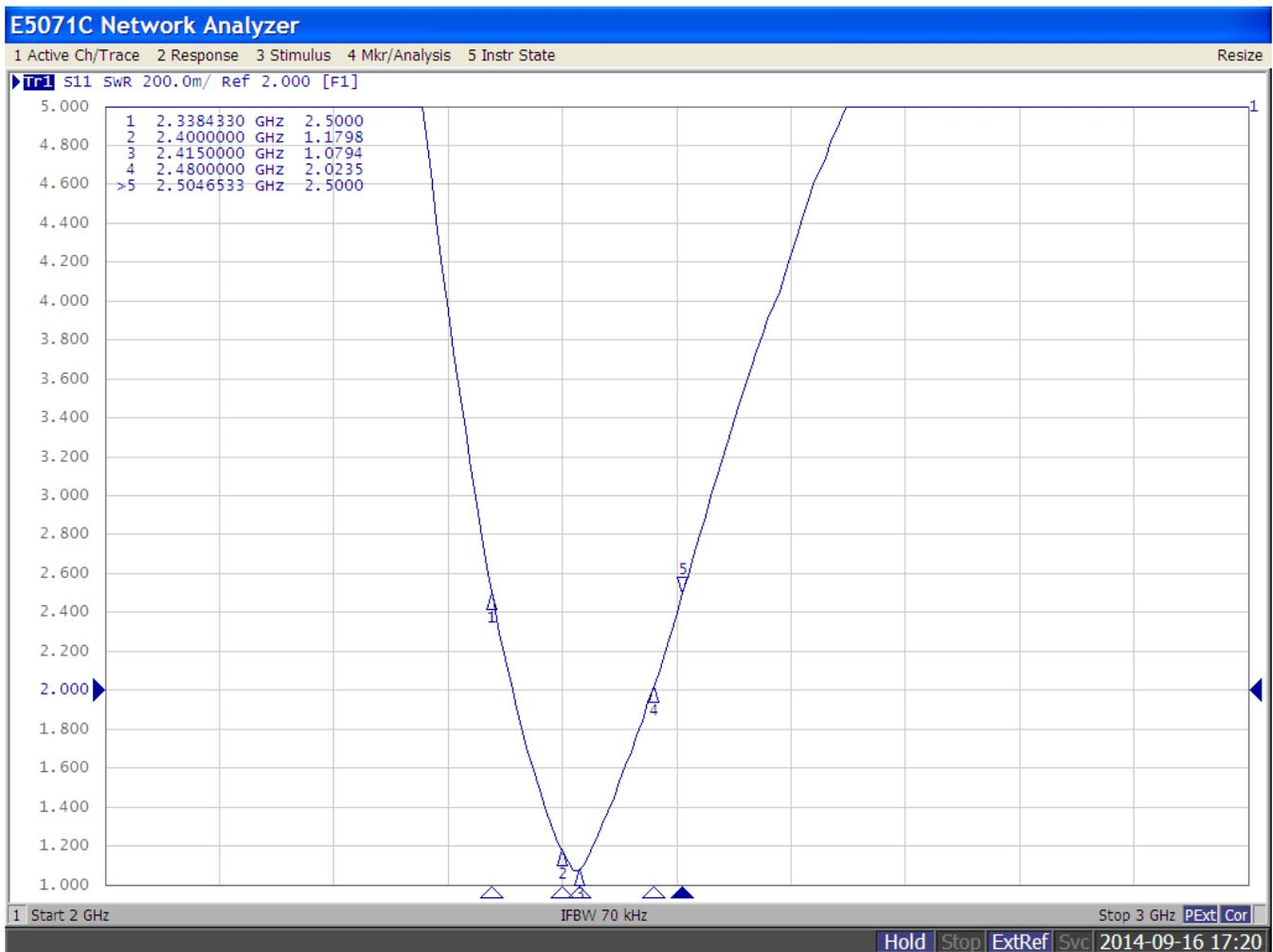

Figure 2 Antenna VSWR measured on a 1.5 mm thick plate of Polycarbonate

FLAT SURFACE ANTENNA RADIATION PERFORMANCE

FlexNotch centered on a 1.5 mm thick plate of Polycarbonate

Antenna Measurement Set-Up

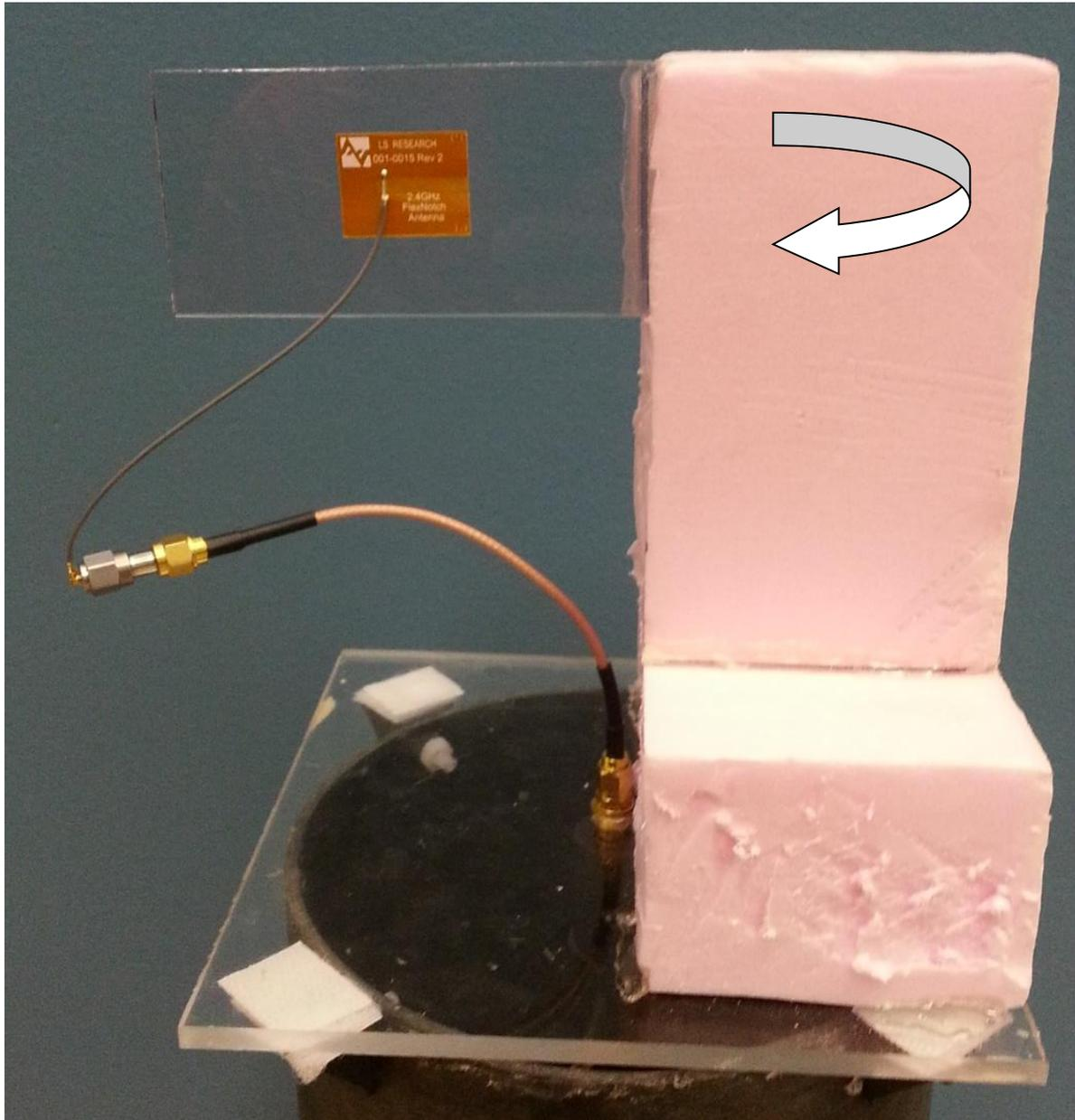

Figure 3 Horizontal Orientation Measurement

Horizontal Orientation at 2440 MHz:

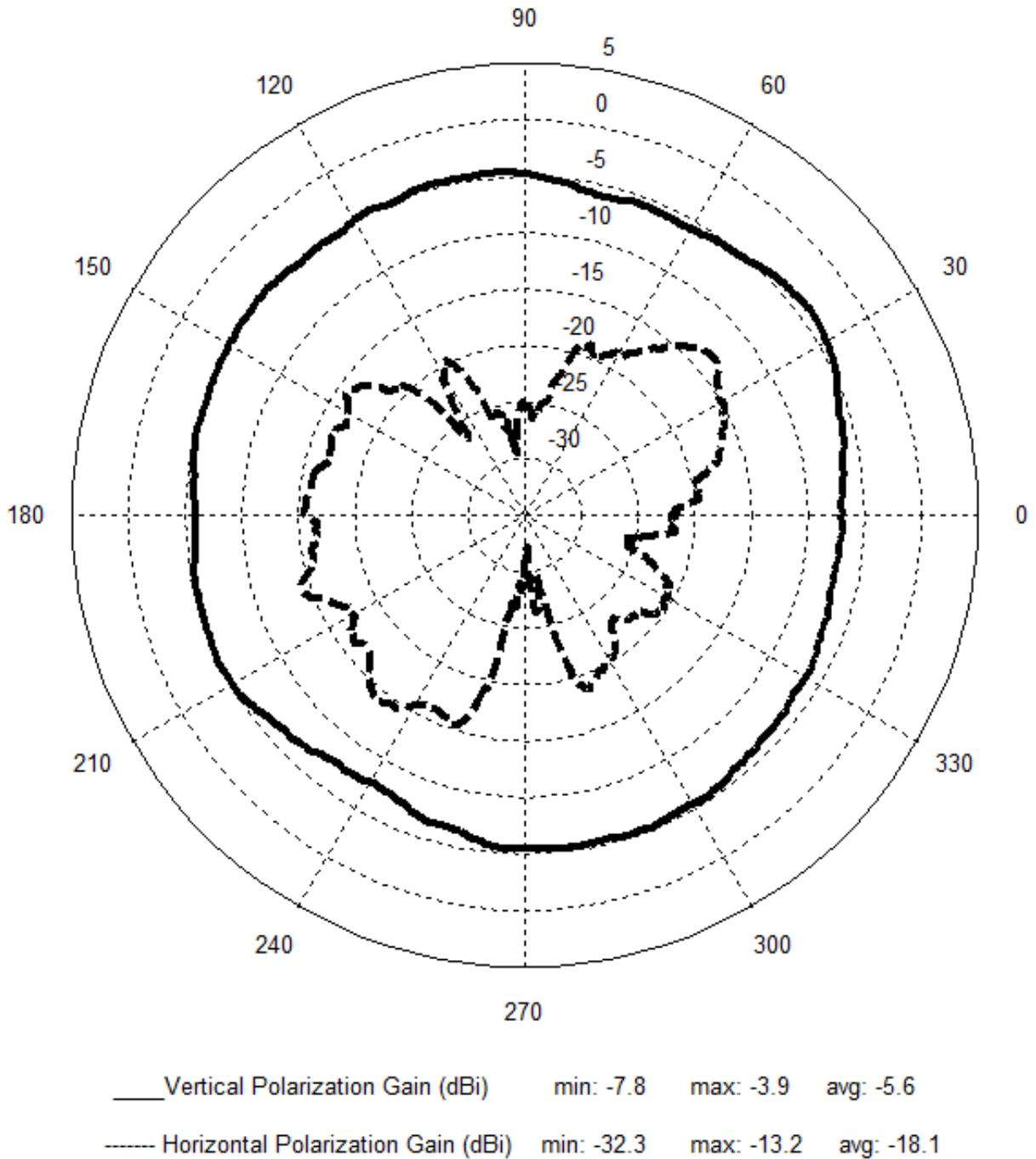

Figure 4 Horizontal Orientation Pattern

The information in this document is subject to change without notice.

Antenna Measurement Set-Up

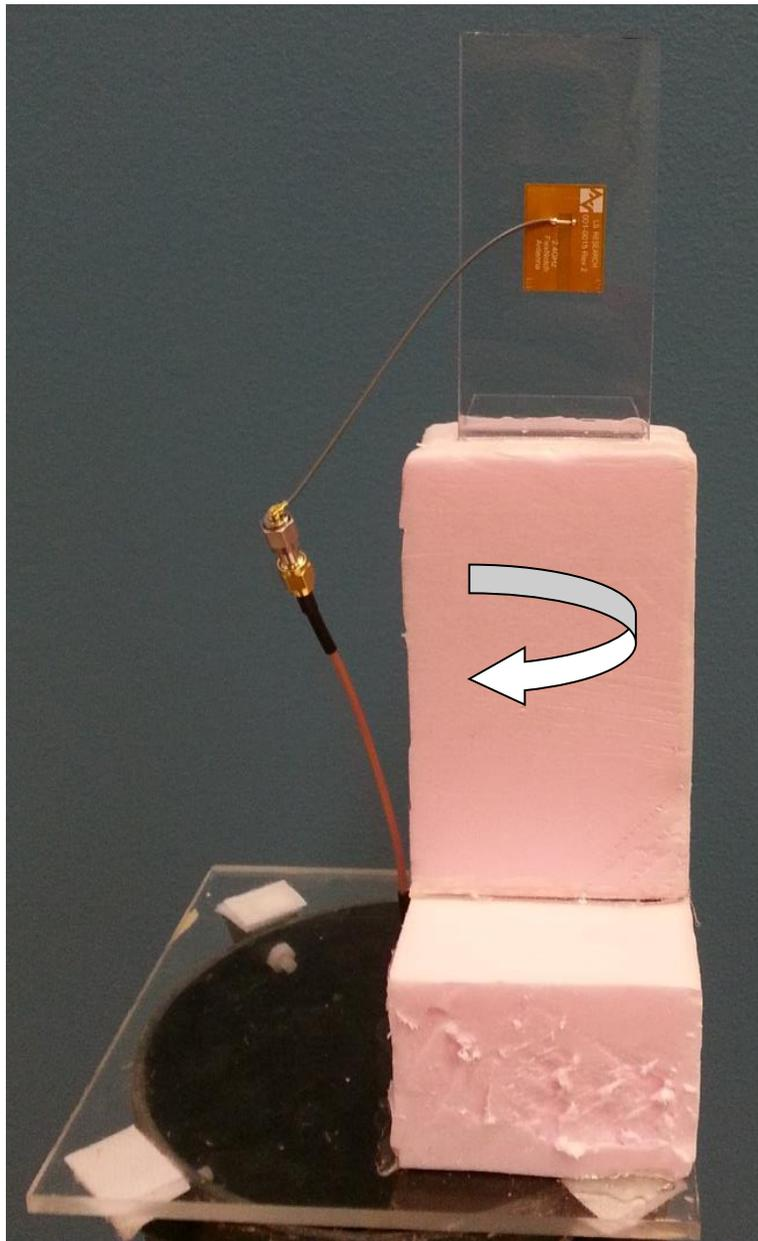

Figure 5 Vertical Orientation Measurement

Vertical Orientation at 2440 MHz:

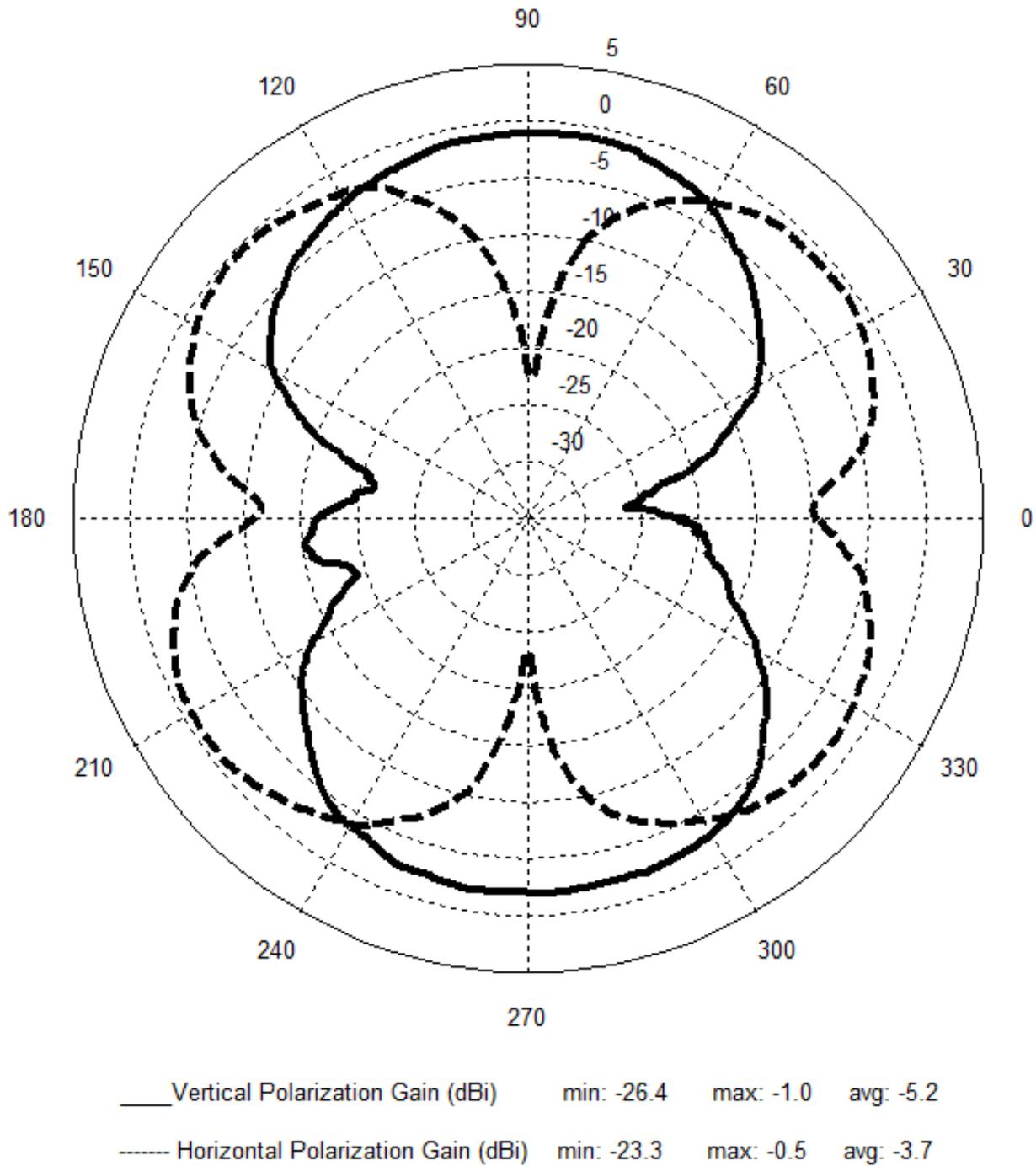

Figure 6 Vertical Orientation Pattern

Antenna Measurement Set-Up

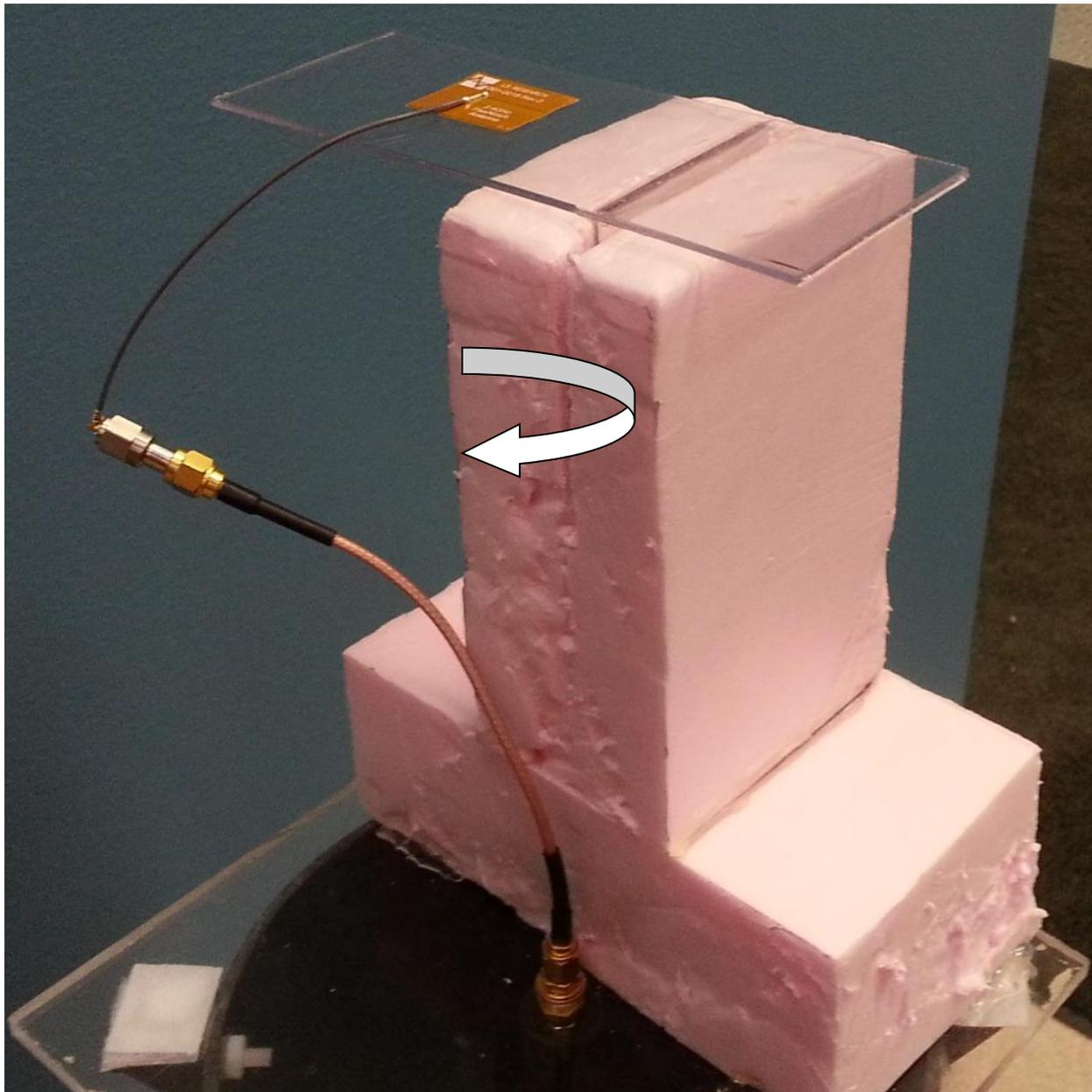

Figure 7 Flat Orientation Measurement

Flat Orientation at 2440 MHz:

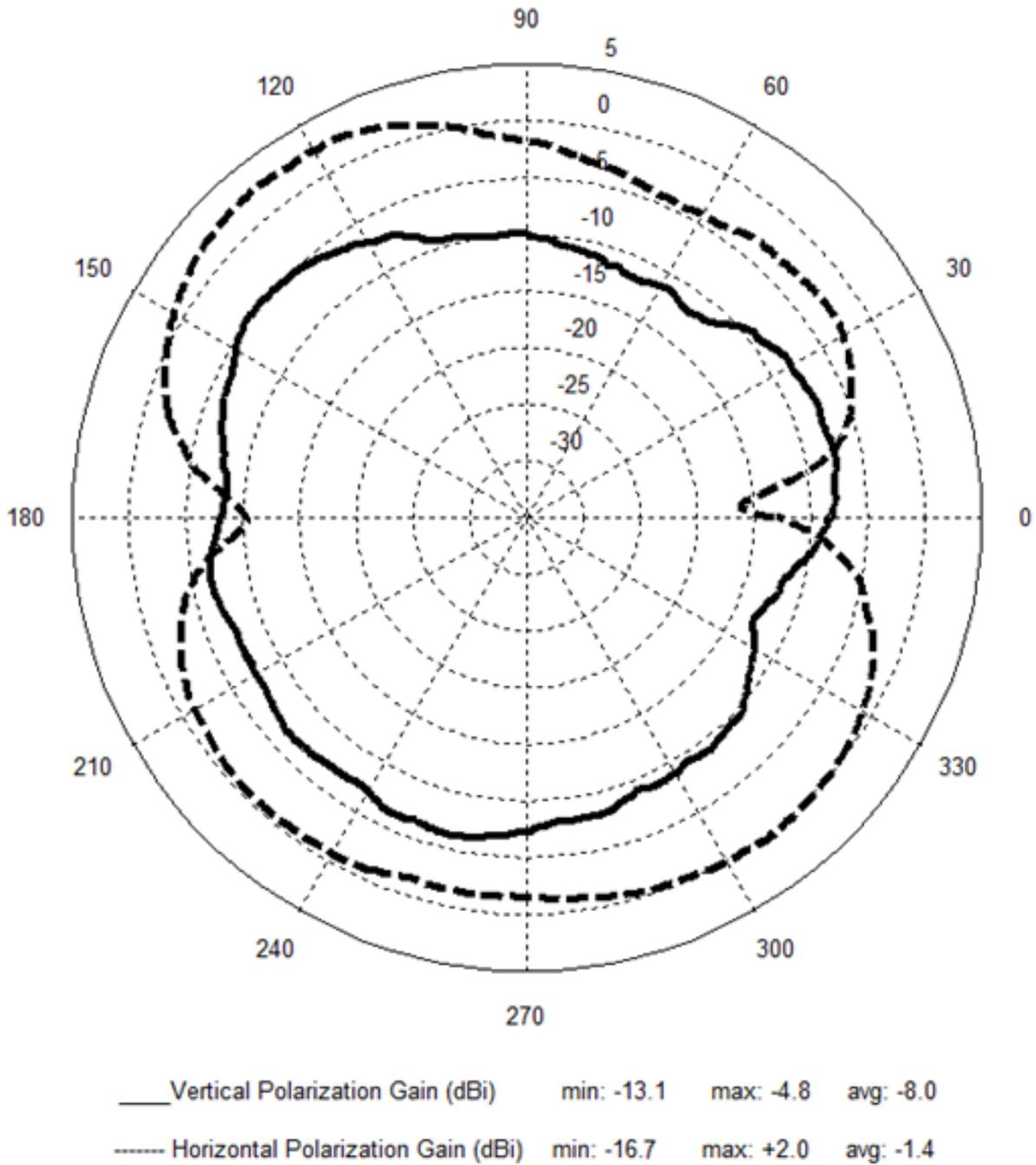

Figure 8 Flat Orientation Pattern

OPTIMAL INSTALLATION GUIDE

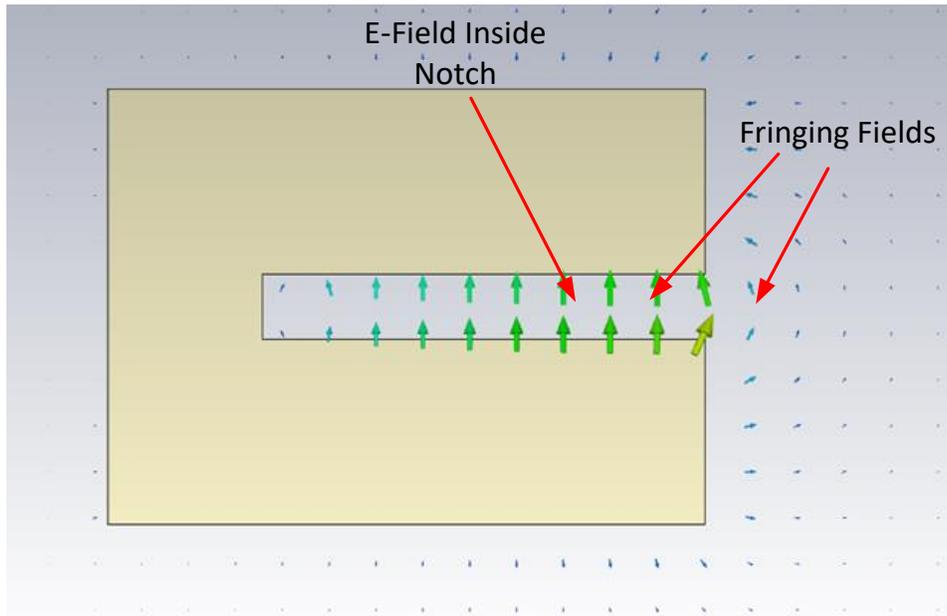

Figure 9 E-Field Radiation from FlexNotch, Taken from CST Simulation

The FlexNotch should be kept clear of any non-metal objects (such as plastics) on top of it by at least 5 mm (see **Figure 10**). Similarly, all four sides of the FlexNotch should be kept clear of any non-metal object by at least 1 mm (See **Figure 11** and **Figure 12**). Mounting the FlexNotch in a situation that does not allow for these clearance recommendations may change the gain characteristics stated in the datasheet, which could impact overall range of the wireless system.

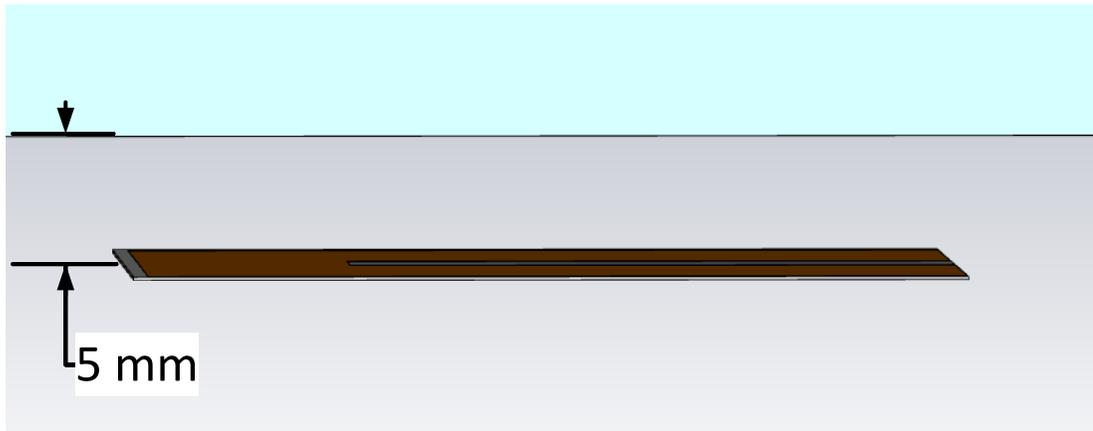

Figure 10 Above FlexNotch Clearance

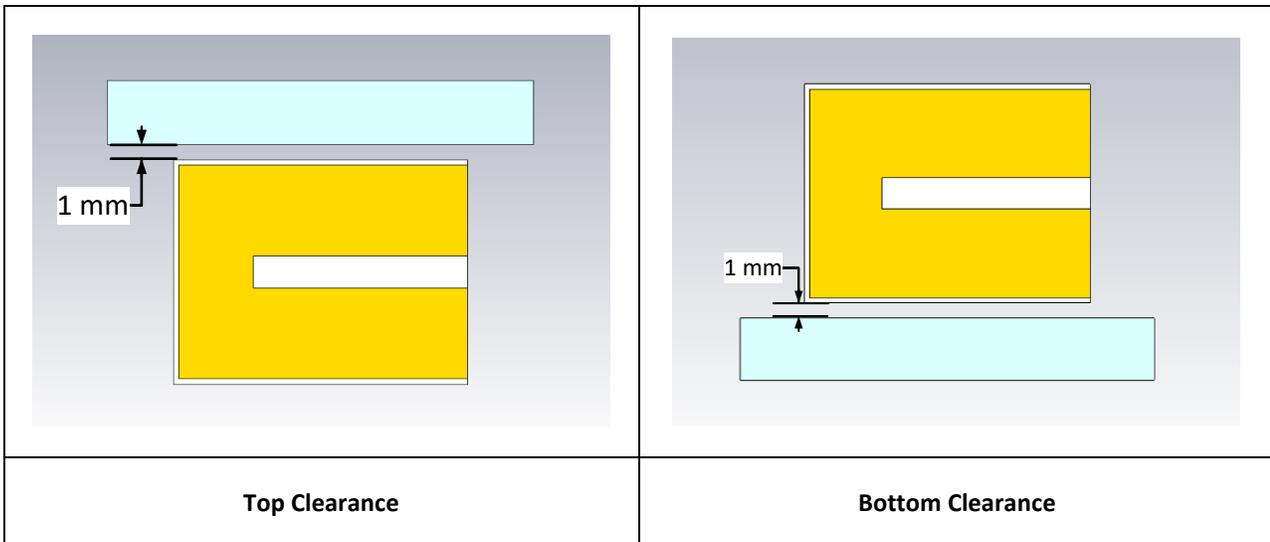

Figure 11 Top and Bottom Clearance

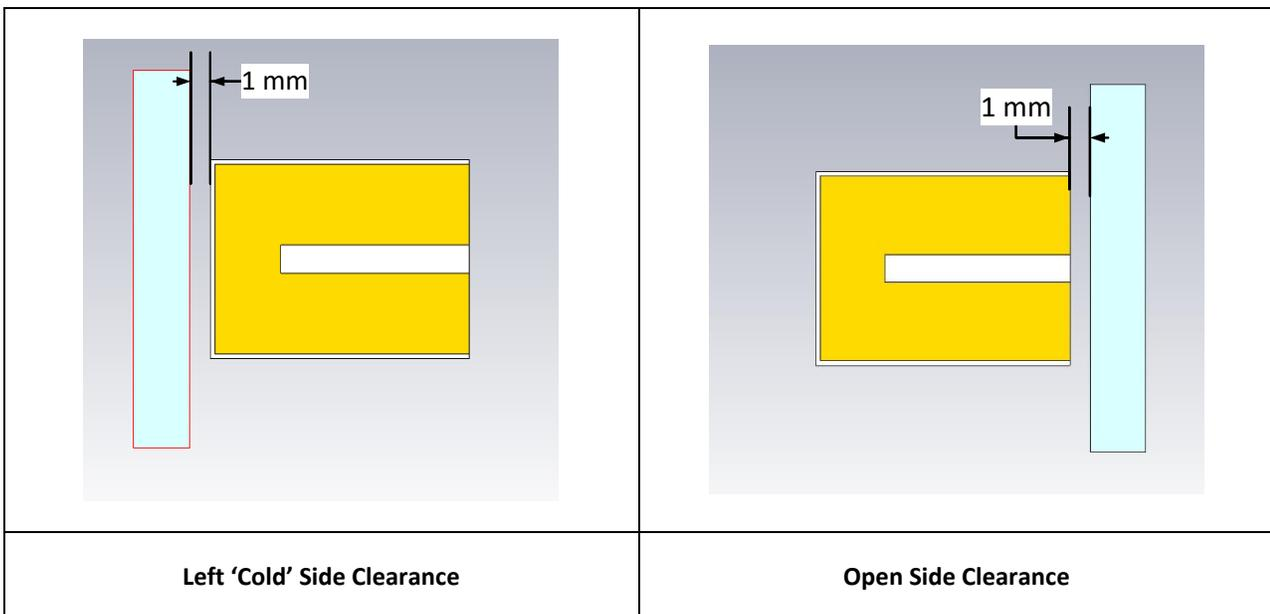

Figure 12 Open Side Clearance

The ideal material for the FlexNotch to be mounted on is 1.5 mm thick polycarbonate; this will result in maximum performance. If the FlexNotch is mounted on a different material, the tuning will change. This can cause a decrease in performance. LSR can retune the FlexNotch for specific implementations and different materials on request.

The coaxial cable feeding the FlexNotch should be routed away from the antenna. Do not run the coaxial cable above the FlexNotch or near the open end of the notch. The cable should be routed perpendicular to the side of the FlexNotch (this is the way the cable comes assembled), around the cold side, or away from the ground wall. All three of these options are shown in **Figure 13**.

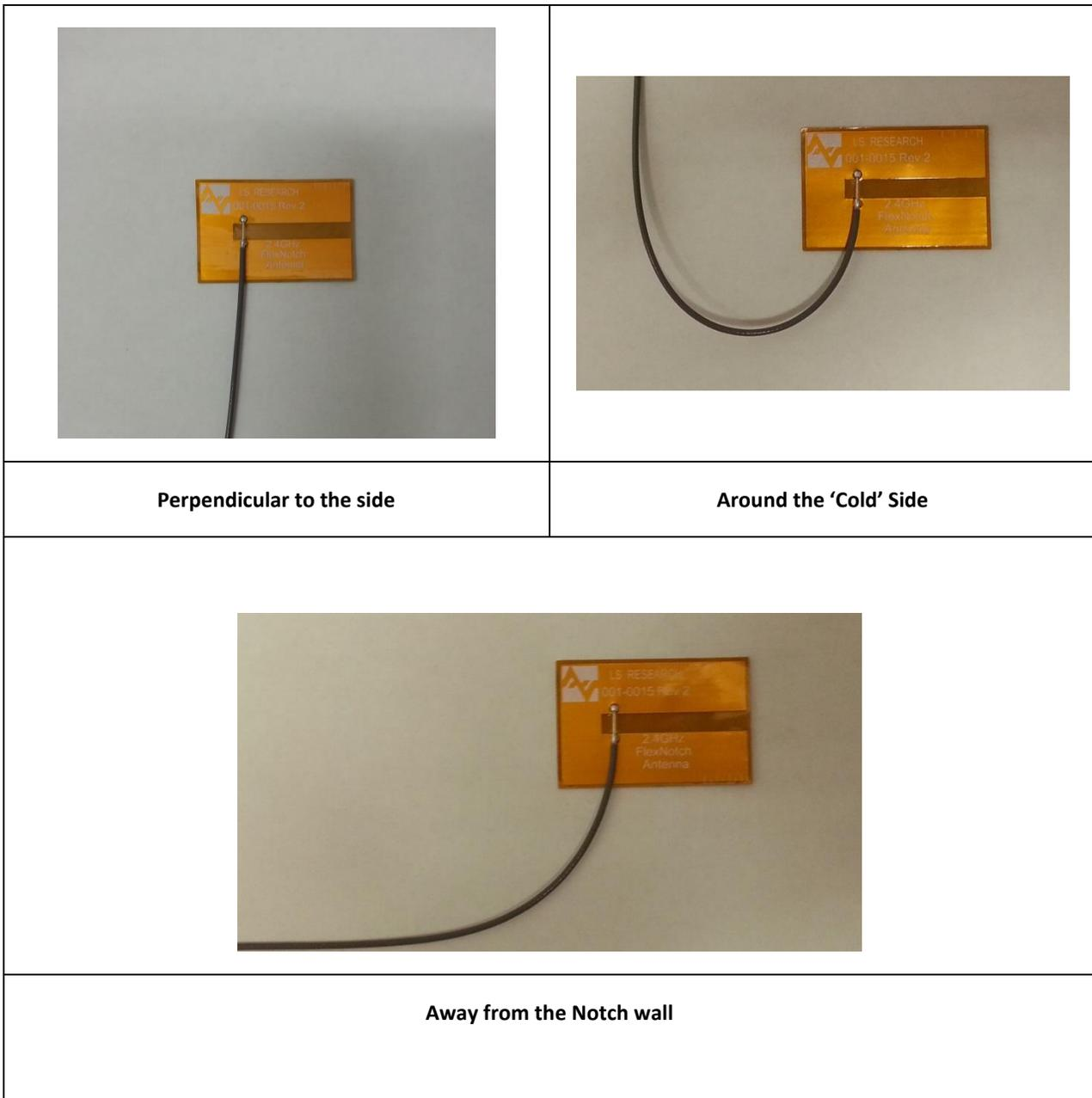

Figure 13 Recommended Cable Routing

As with any antenna, care should be taken not to place conductive materials or objects near the antenna. The radiated fields from the antenna will induce currents on the conductive surface; as a result those currents then produce their own radiation. These re-radiating fields from the metal will interfere with the fields radiating from the FlexNotch (this is true for any antenna). Other objects, such as an LCD display, placed in close proximity to the antenna may not affect its tuning but it can distort the radiation pattern. Materials that absorb electromagnetic fields should be kept away from the antenna to maximize performance. Common things to keep in mind when placing the antenna:

Wire Routing

Speakers – these generate magnetic fields

Metal Chassis and Frames

Battery Location

Proximity to Human Body

Display Screen – these will absorb radiation

Paint – do not use metallic coating or flakes

Flex Limits of the FlexNotch

One of the unique features of the FlexNotch is its ability to flex. However, due to the adhesive there are limits as to how much the antenna can be flexed and remain secured to the device. The FlexNotch should not be flexed in a convex position with a radius less than 16 mm. Going smaller than this may result in the antenna peeling off the surface over time. Should a tighter radius of curvature be required, it is recommended you contact LSR Design Services for assistance.



Figure 14 Convex Mounted

The FlexNotch should not be flexed in a concave position with a radius less than 16 mm. Similar to the restrictions on the convex position, potential exists for the adhesive to peel off over time if the FlexNotch is bent beyond a 16 mm radius. If a tighter radius of curvature is required, it is recommended you contact LSR for assistance. The FlexNotch is not designed to be twisted or crumpled. The adhesive back should lay flush with the surface it is mounted on.

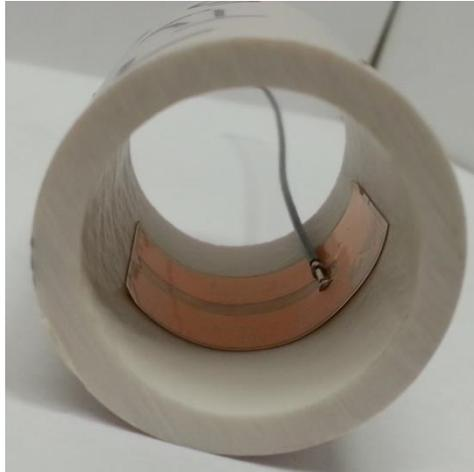

Figure 15 Concave Mounted

Mounting on Metal and Body Loaded Applications

The FlexNotch can tolerate being near conductive surfaces. A 1 mm clearance should be observed between the top, bottom, and cold sides of the FlexNotch from any metal (see **Figure 11**). Metal should be kept away from the open end of the FlexNotch by at least 10 mm. However, any metal in close proximity to the open end will disrupt the radiation pattern and could cause a decrease in antenna gain.

Keep any metal above the FlexNotch away by at least 10 mm; this will prevent the antenna from detuning. However, this will still cause some distortion of the radiation pattern. **Do NOT mount the FlexNotch on a metal surface.**

These same guidelines also apply to body worn applications.

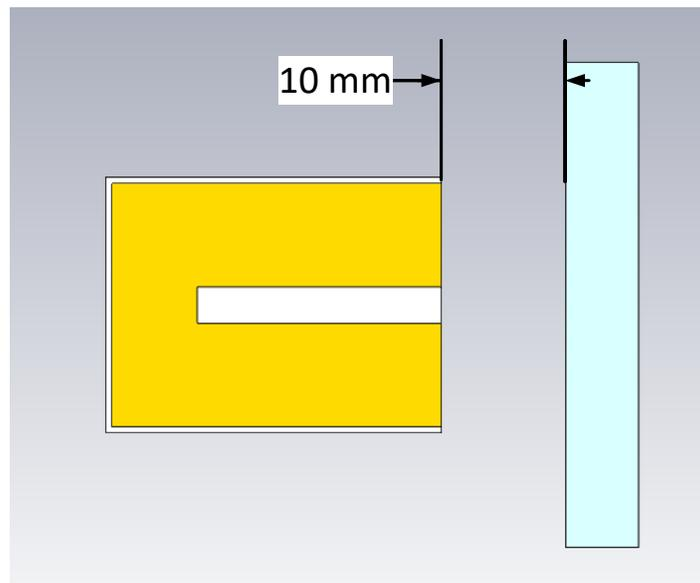

Figure 16 Open Side Metal Clearance

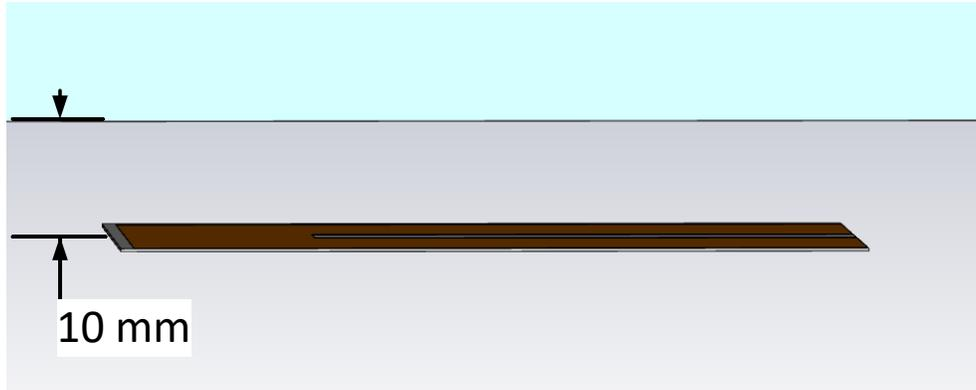

Figure 17 Above Notch Metal Clearance

CUSTOMER SPECIFIC TUNING

LSR will assist with custom tuning of the antenna for your specific end product. Simply send LSR a sample of your enclosure or platform, and LSR will tune an antenna for you. LSR will send the results back indicating which trim mark the antenna should be cut to, to optimize performance. You then trim the antennas at time of assembly to the indicated hash mark and stick to your product.

001-0023 (MHF4L Connector)

Rev 1: Initial Production Release

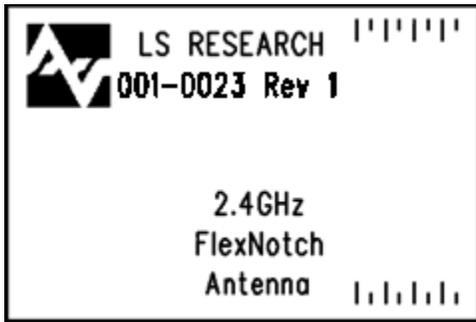

Rev 2: Changed Supplier – Color Change to Antenna

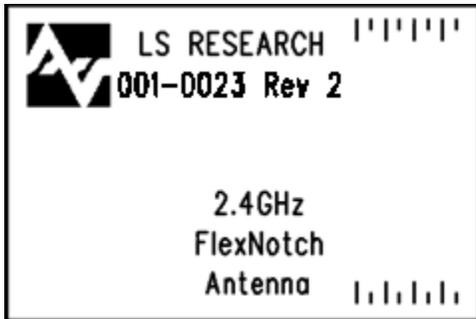

CONTACTING LSR

Headquarters	LS Research, LLC W66 N220 Commerce Court Cedarburg, WI 53012-2636 USA Tel: 1(262) 375-4400 Fax: 1(262) 375-4248
Website	www.lsr.com
Technical Support	forum.lsr.com
Sales Contact	sales@lsr.com

© Copyright 2018 Laird. All Rights Reserved. Patent pending. Any information furnished by Laird and its agents is believed to be accurate and reliable. All specifications are subject to change without notice. Responsibility for the use and application of Laird materials or products rests with the end user since Laird and its agents cannot be aware of all potential uses. Laird makes no warranties as to non-infringement nor as to the fitness, merchantability, or sustainability of any Laird materials or products for any specific or general uses. Laird, Laird Technologies, Inc., or any of its affiliates or agents shall not be liable for incidental or consequential damages of any kind. All Laird products are sold pursuant to the Laird Terms and Conditions of Sale in effect from time to time, a copy of which will be furnished upon request. When used as a tradename herein, Laird means Laird Limited due to the acquisition by Advent or one or more subsidiaries of Laird Limited. Laird™, Laird Technologies™, corresponding logos, and other marks are trademarks or registered trademarks of Laird. Other marks may be the property of third parties. Nothing herein provides a license under any Laird or any third party intellectual property right.

The information in this document is subject to change without notice.

Mouser Electronics

Authorized Distributor

Click to View Pricing, Inventory, Delivery & Lifecycle Information:

[Laird:](#)

[001-0015](#)