

LOC	DIST	REVISIONS					
E	B	P	LTR	DESCRIPTION	DATE	DWN	APVD
			BA	NEW RELEASE	06-AUG-09	SM	St.P

FOR FURTHER INFORMATION SEE DATA SHEET FOR
CRG SERIES-THICK FILM CHIP RESISTORS

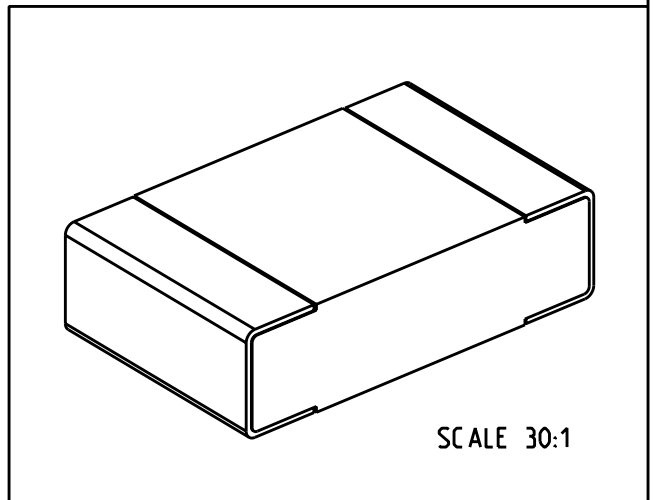

RoHS Compliant



2009

RELEASED FOR PUBLICATION

THIS DRAWING IS UNPUBLISHED.

BY TYCO ELECTRONICS CORPORATION. ALL RIGHTS RESERVED.

© COPYRIGHT 2009

DIMENSIONS:		DWN	06-AUG-09	MATERIAL	-	FINISH	-
mm		CHK	06-AUG-09	Tyco Electronics Corporation Dorcan, Swindon, SN3 5HH			
TOLERANCES UNLESS OTHERWISE SPECIFIED:		APVD	06-AUG-09				
0 PLC	± 0.5	PRODUCT SPEC	-	NAME			
1 PLC	± 0.2	APPLICATION SPEC	-	THICK FILM CHIP RESISTORS			
2 PLC	± 0.1	WEIGHT	-	SIZE	CAGE CODE	DRAWING NO	RESTRICTED TO
3 PLC	± -			A 4	00779	C- 1623292	-
4 PLC	± -			CUSTOMER DRAWING			
ANGLES	± 5°			SCALE	40:1	SHEET	1 OF 1
				REV BA			

Mouser Electronics

Authorized Distributor

Click to View Pricing, Inventory, Delivery & Lifecycle Information:

[TE Connectivity:](#)

[CRG0805F8K2](#)