

## SPECIFICATION

- Part No. : **PA.25A**
- Product Name : Anam Hexa-Band Cellular SMT Antenna  
GSM / CDMA / DCS / PCS / WCDMA / UMTS /  
HSDPA / GPRS / EDGE  
800 MHz to 2200 MHz
- Features : Compact High Efficiency Antenna  
Surface Mount Device  
Dims: 35\*5\*6mm  
RoHS Compliant



## **1. Introduction**

This ceramic multiband cellular antenna uses high grade ceramics which have been developed in Taoglas through years of expertise in delivering the right materials for high performance antennas. Taoglas designers, through constant research and development have been able to “fit” 6 bands in a small area, while also achieving high efficiency. The PA.25 is a unique SMT solution which is delivered on tape and reel. For very detailed integration information additional to this specification please download our comprehensive PA.25 integration application note from our website.

## 2. Specification Table

ELECTRICAL		
Standard	4G/3G/2G	
Operation Frequency (MHz)	824-960	1710-2170
Peak Gain (dBi)	2.00	3.51
Average Gain (dBi)	-1.55	-2.39
Efficiency (%)	70.43	58.16
VSWR	<3:1	
Impedance	50Ω	
Polarization	Linear	
Radiation Properties	Omnidirectional	
Max Input Power	5 W	

- The antenna was tested on a 110\*40mm ground plane and covered by 2mm thick ABS plastic.
- Actual Antenna Electrical performance will depend on customer ground plane size.

MECHANICAL	
Dimensions	35*5*6mm
Material	Ceramic
Termination	Ag (environmental-friendly Pb free)
Weight	3g
EVB Connector	SMA(F)
ENVIRONMENTAL	
Operation Temperature	-40°C to 85°C
Storage Temperature	-40°C to 105°C
Relative Humidity	Non-condensing 65°C 95% RH
RoHs Compliant	Yes

## 3. Test Configuration

### 3.1. Test Setup

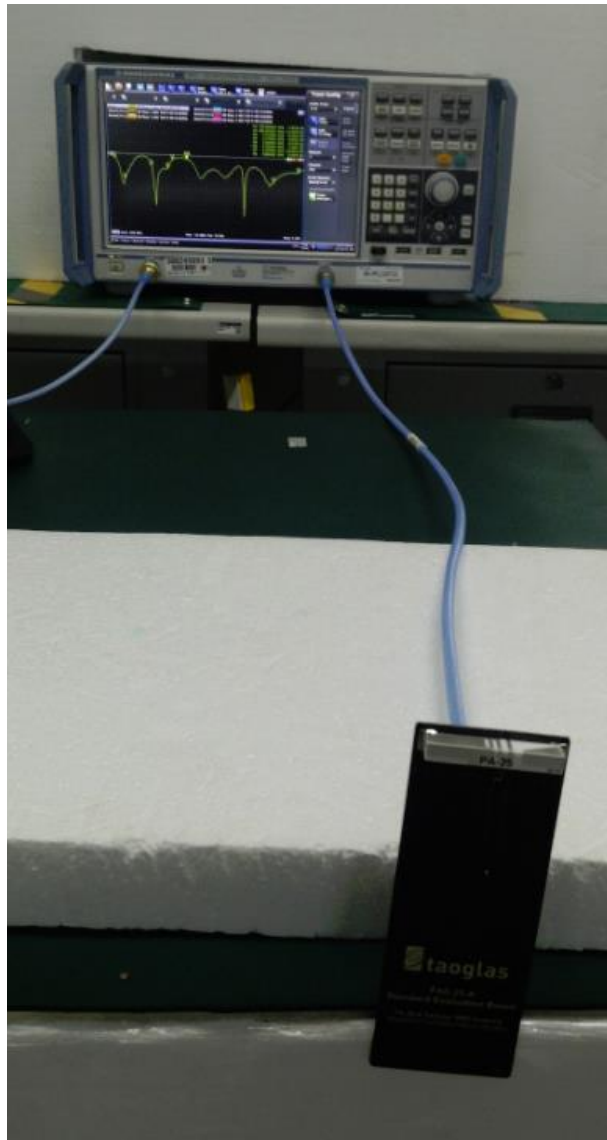

In free space

### 3.2. Return Loss

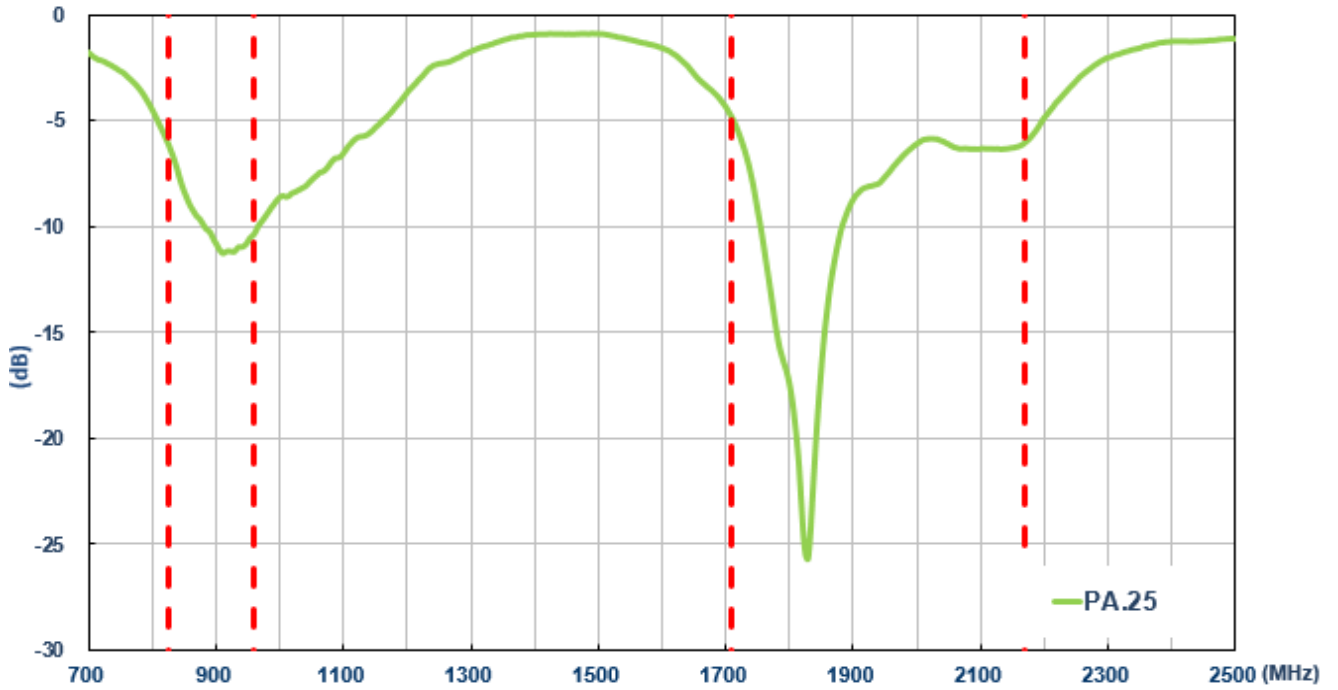

### 3.3. Efficiency

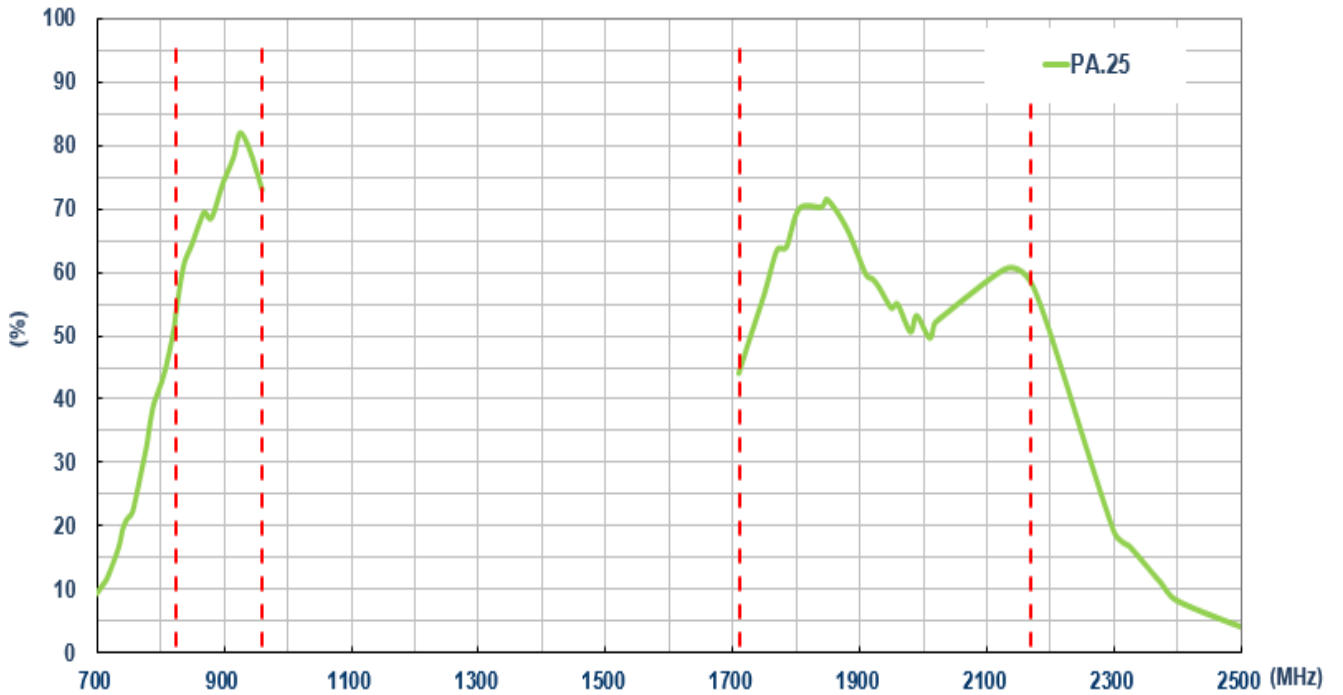

### 3.4. Peak Gain

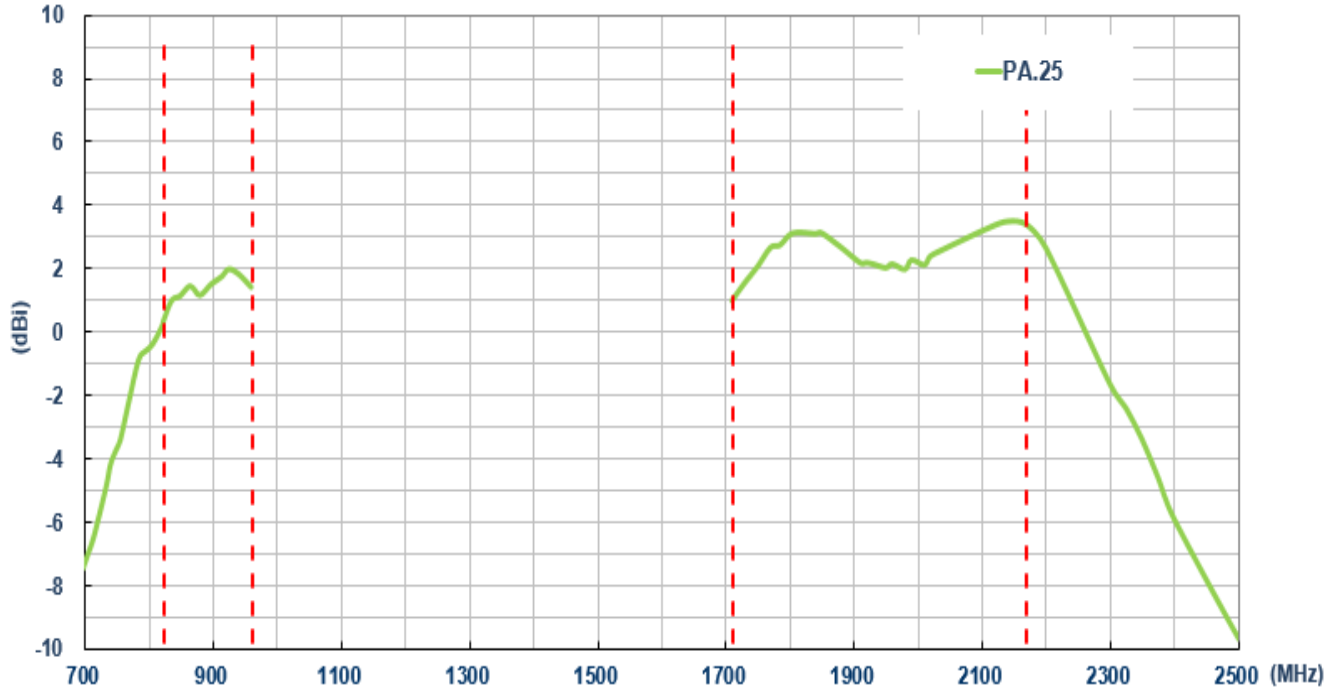

### 3.5. Average Gain

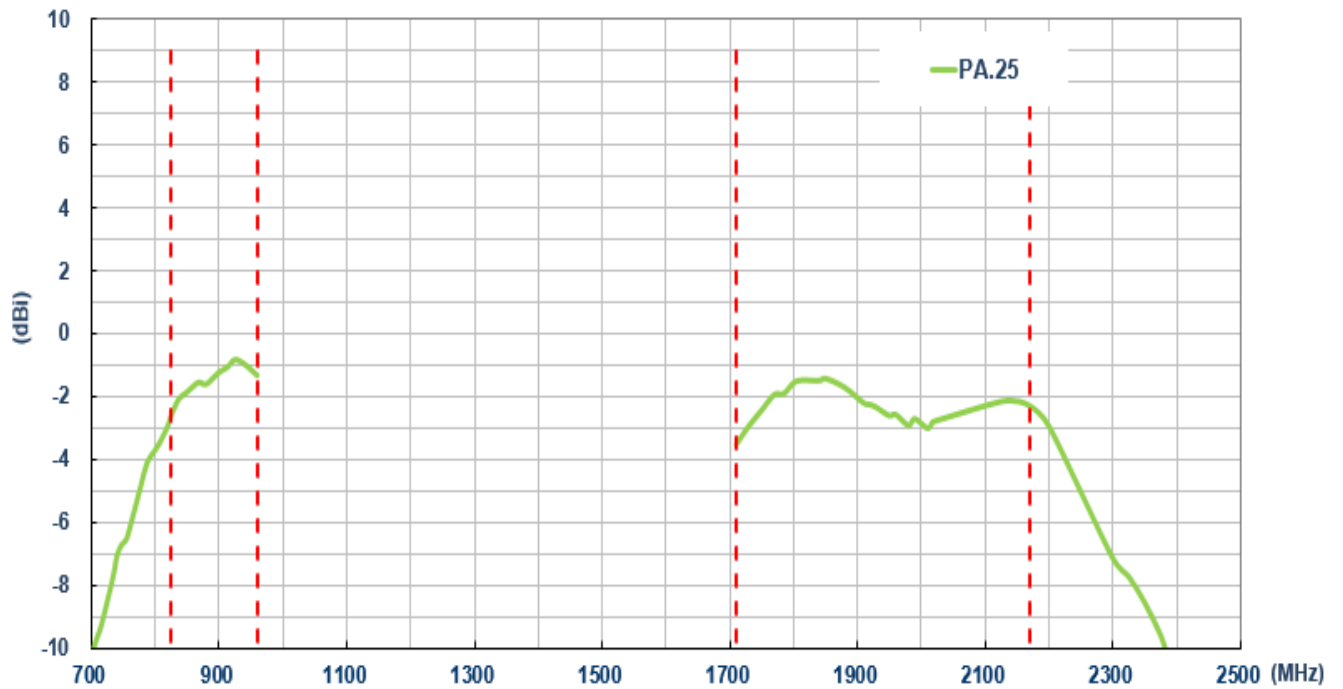

## 4. Radiation Pattern

### 4.1. Test Setup

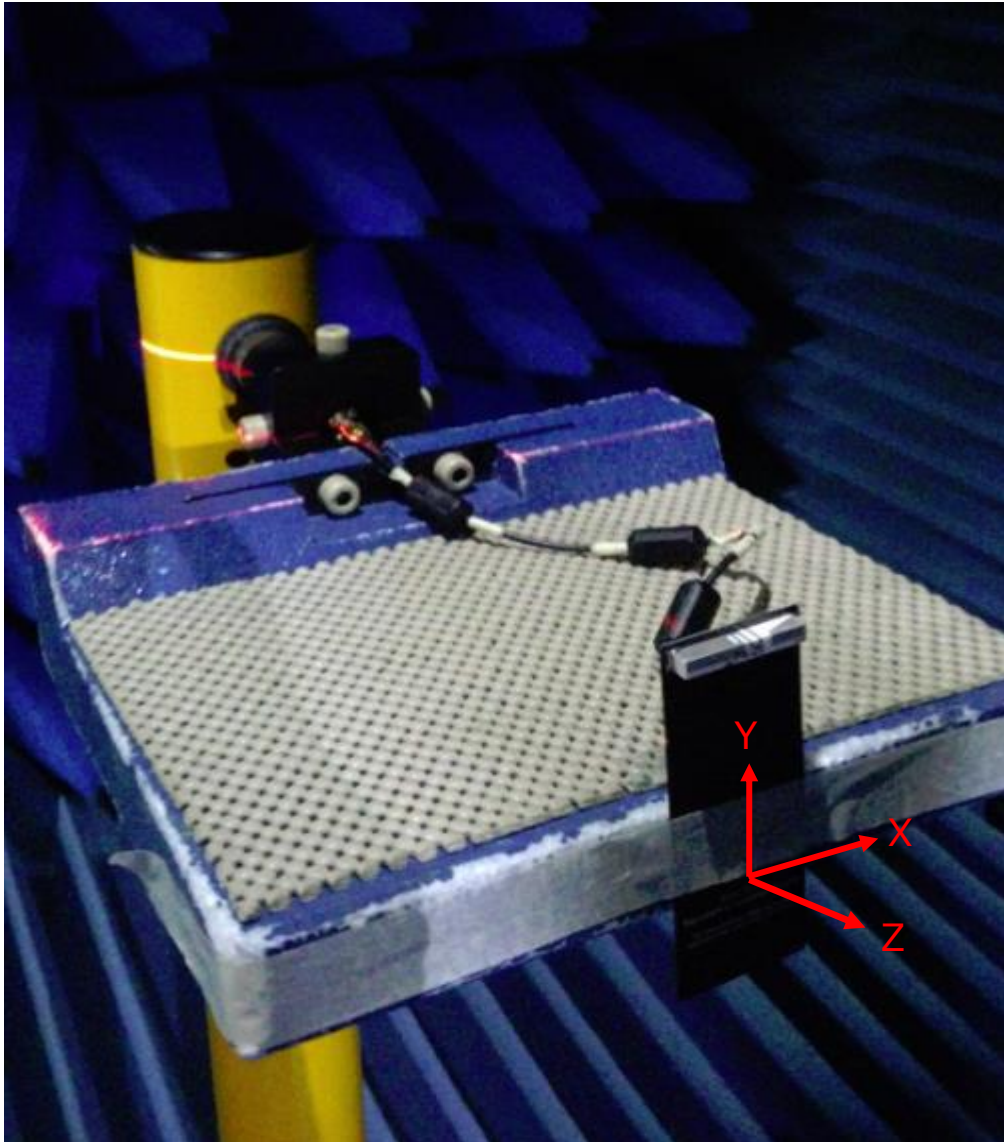

In free space

## 4.2. 2D Radiation Patterns

### 4.2.1. 824MHz – 960MHz

XY Plane

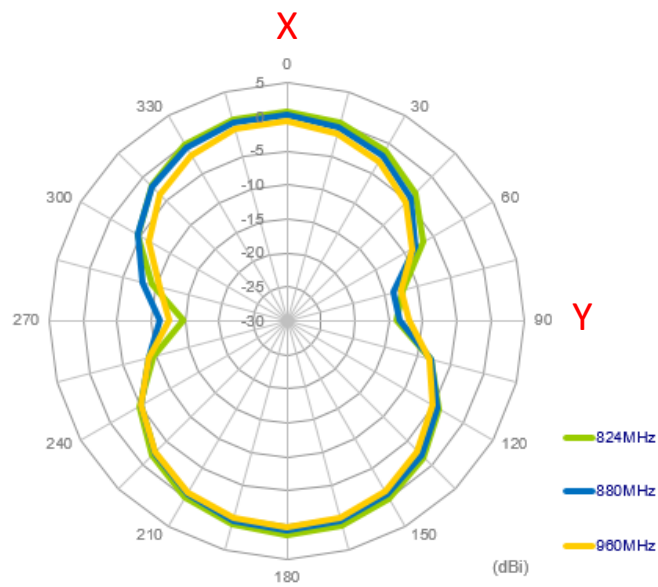

XZ Plane

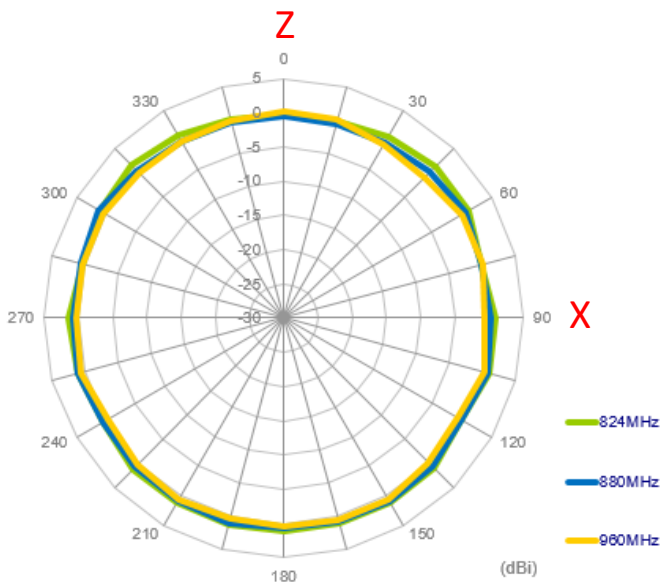

YZ Plane

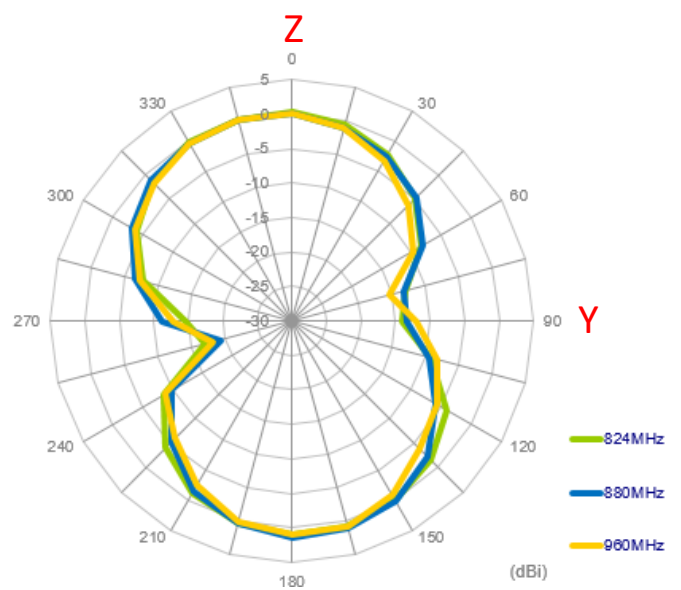



### 4.2.2. 1710MHz – 2170MHz

XY Plane

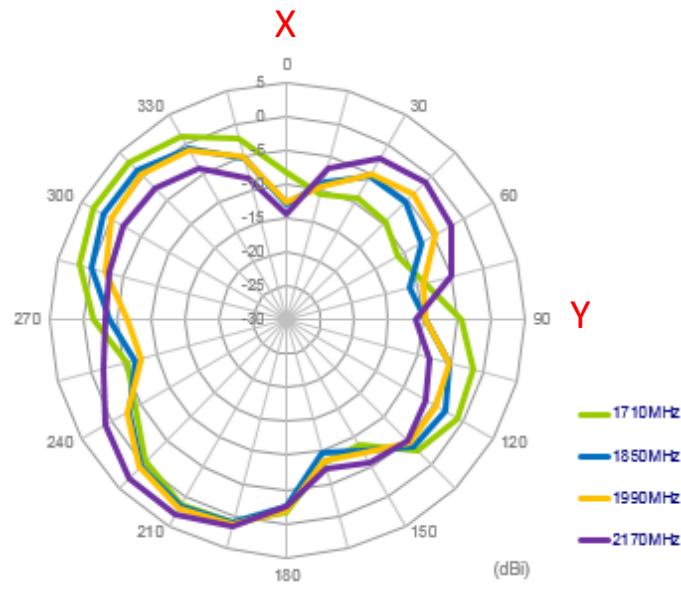

XZ Plane

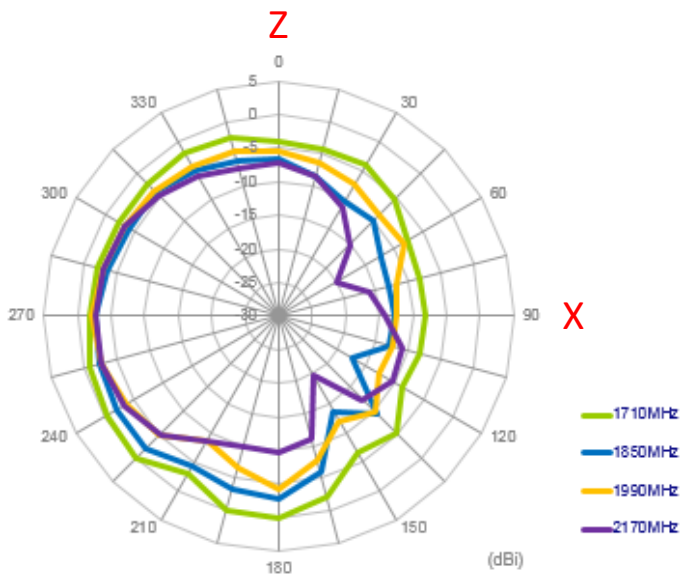

YZ Plane

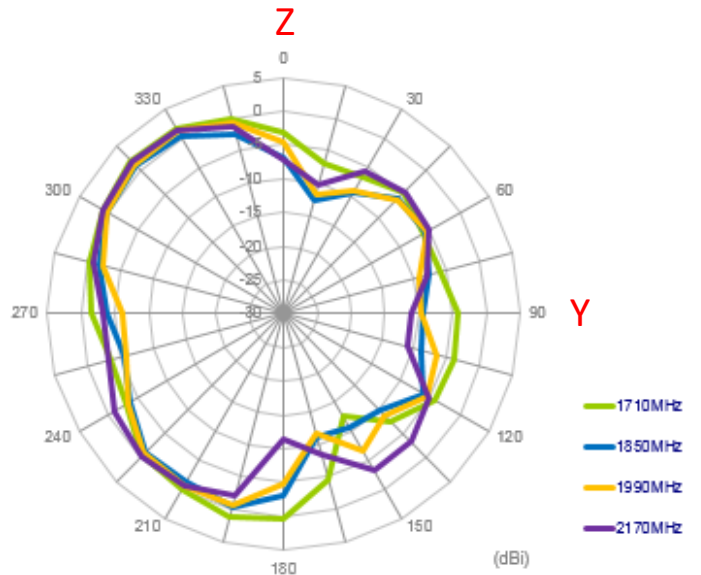

### 4.2.3. 3D Radiation Patterns

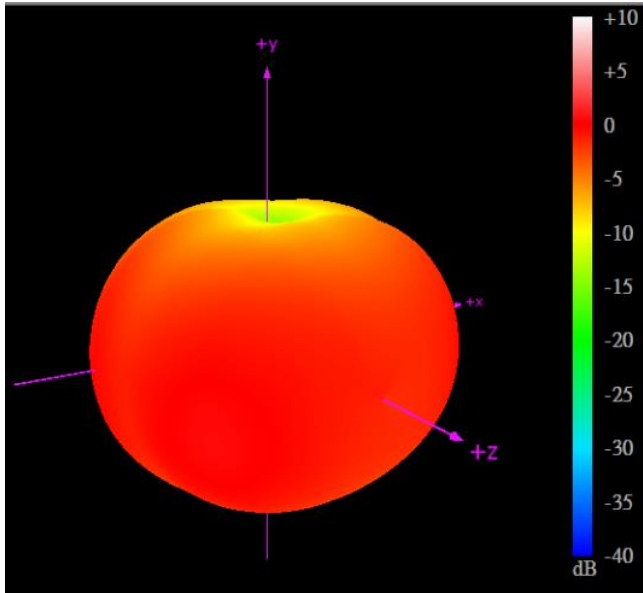

824MHz

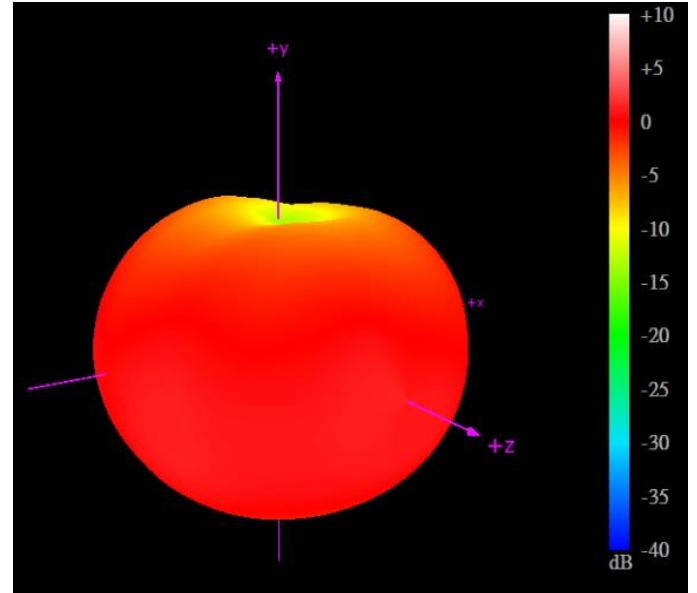

960MHz

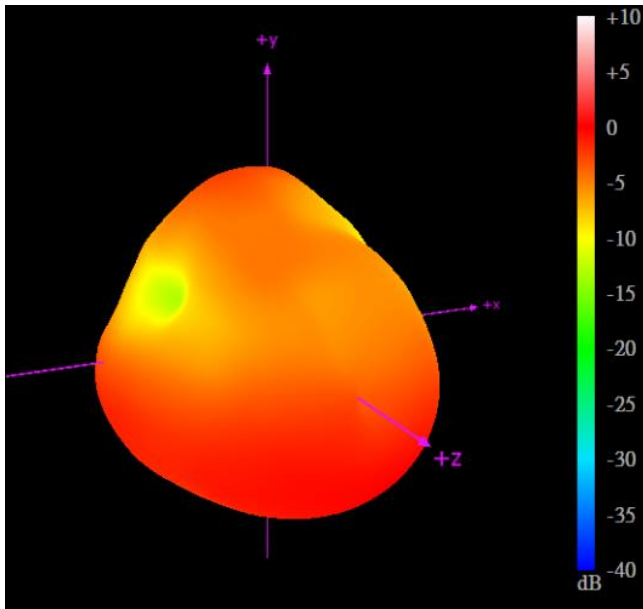

1710MHz

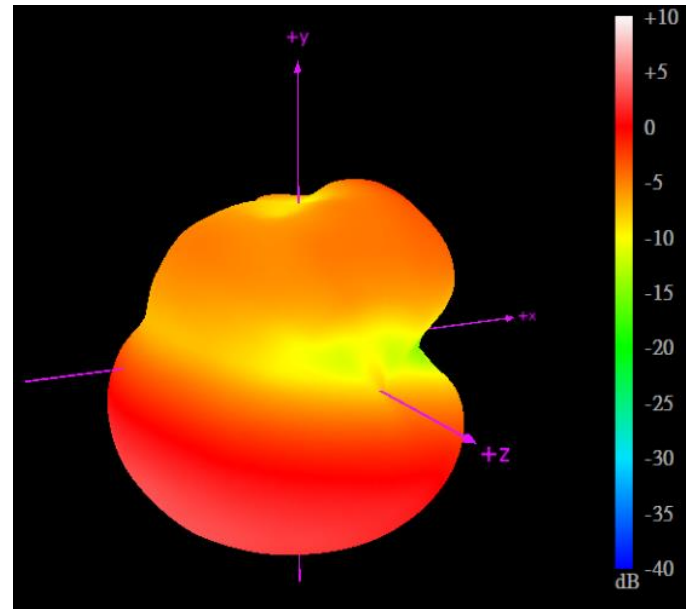

1850MHz

## 5. Mechanical Drawings (Unit: mm)

### 5.1. Antenna Dimensions

3D View

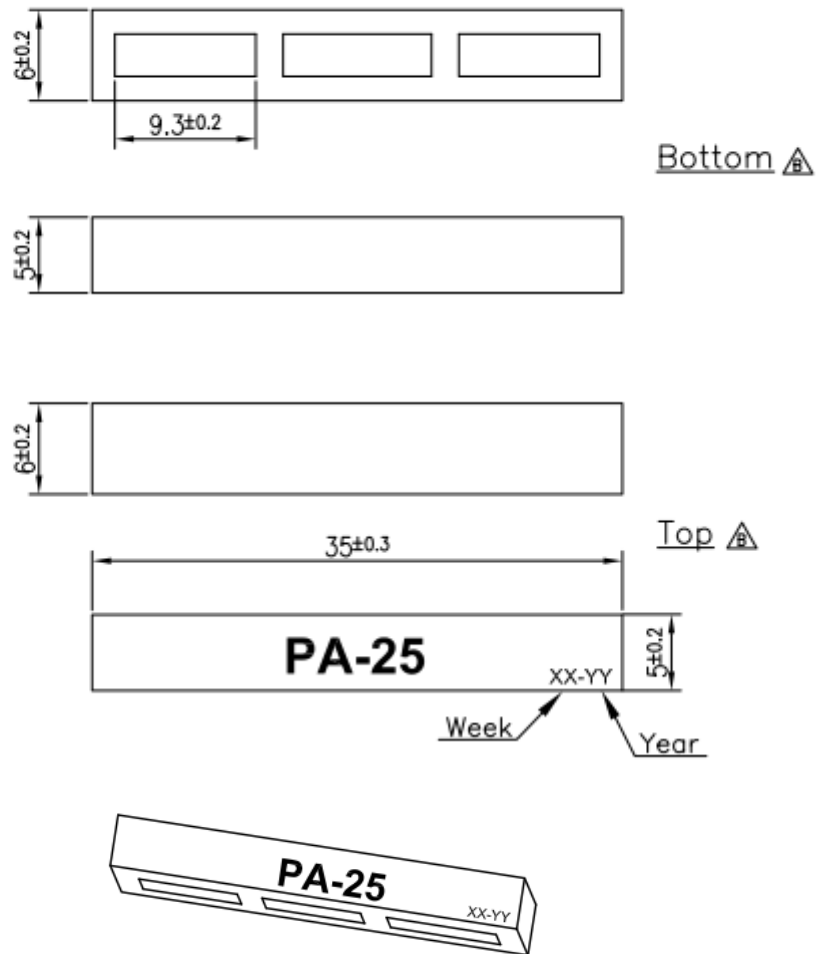

3D View

## 5.2. Antenna Footprint

Footprint  
0.8t PCB

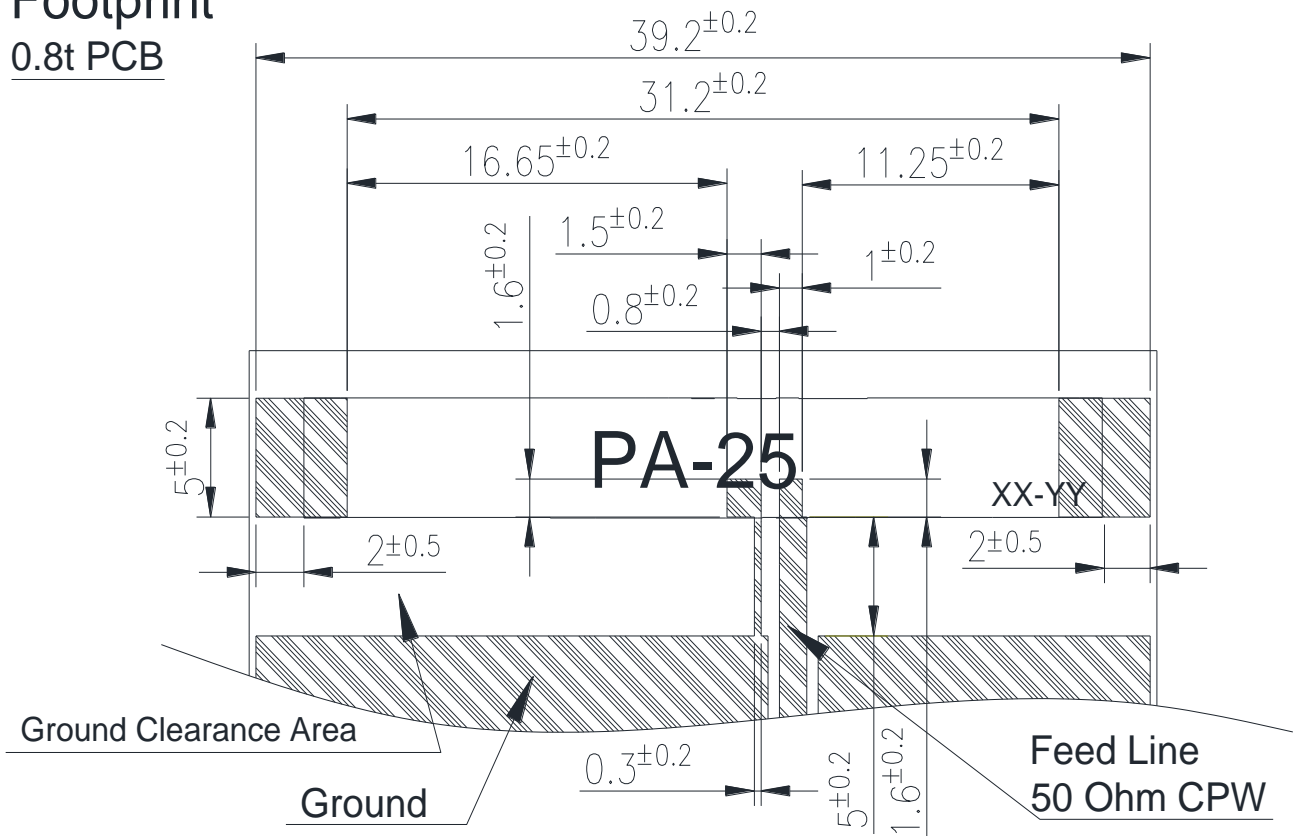

## 6. EVB Drawing (Unit: mm)

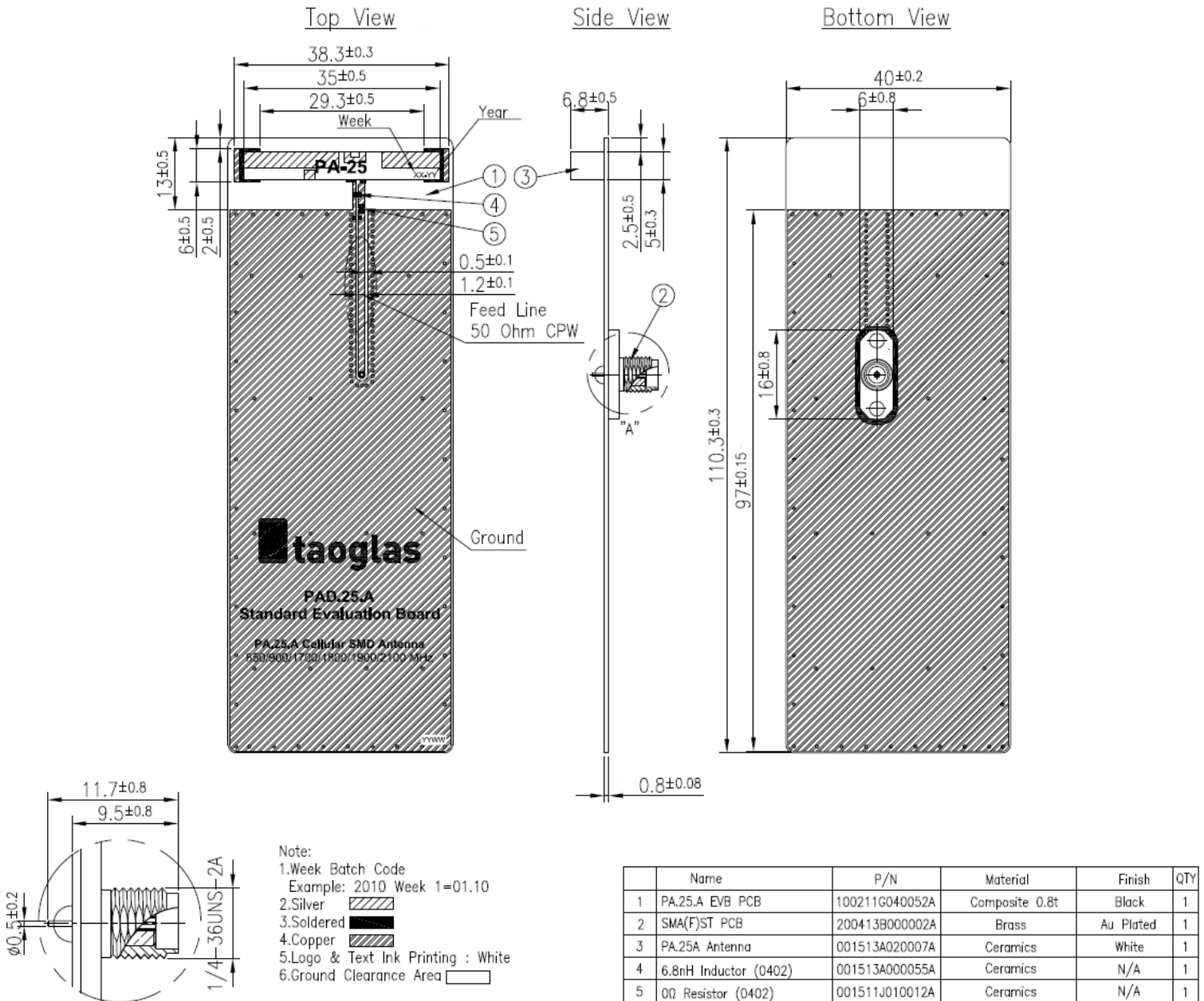

## 7. Transmission Line and Matching Component

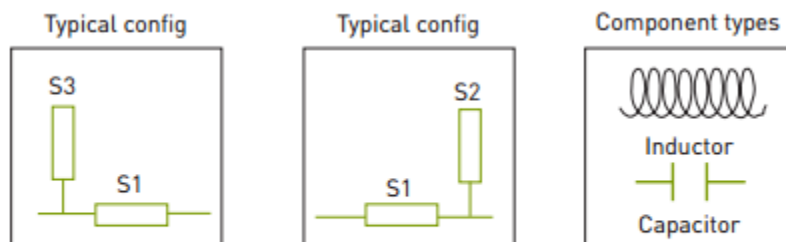
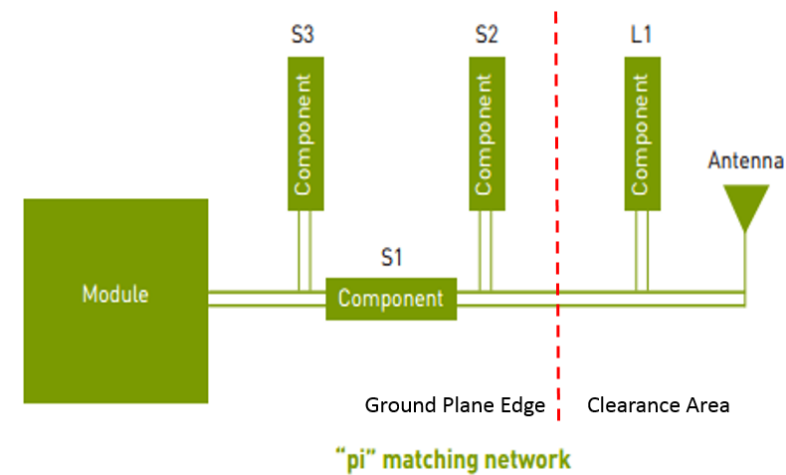

**"L" and "Inverted-L" matching network**

A matching component (L1 in the above drawing) in parallel with the PA.26A is required for the antenna to have optimal performance on the evaluation board, located outside of the ground plane in the space specified in the above drawings.

Additional matching components may be necessary for your device, so we recommend incorporating extra component footprints, forming a "pi" network, between the cellular module and the edge of the ground plane.

## 8. Recommended Reflow Temperature Profile

The PA.25 can be assembled following either Sn-Pb or Pb-Free assembly processes. The recommended soldering temperatures are as follows:

Phase	Profile Features	Sn-Pb Assembly	Pb-Free Assembly (SnAgCu)
Ramp-Up	Avg Ramp-Up Rate (T <sub>smax</sub> to T <sub>p</sub> )	3°C/second (max)	3°C/second (max)
Preheat	Temperature Min (T <sub>smin</sub> ) Temperature Max (T <sub>smax</sub> ) Time (t <sub>smin</sub> to t <sub>smax</sub> )	100°C 150°C 60-120 seconds	150°C 200°C 60-120 seconds
Reflow	Temperature (T <sub>L</sub> ) Total Time Above T <sub>L</sub> b(t <sub>L</sub> )	183°C 60-150 seconds	217°C 60-150 seconds
Peak	Temperature (T <sub>p</sub> ) Time (t <sub>p</sub> )	235°C 10-30 seconds	260°C 20-40 seconds
Ramp-Down	Rate	6°C/second (max)	6°C/second (max)
Time from 25°C to peak Temperature		6 minutes max	8 minutes max

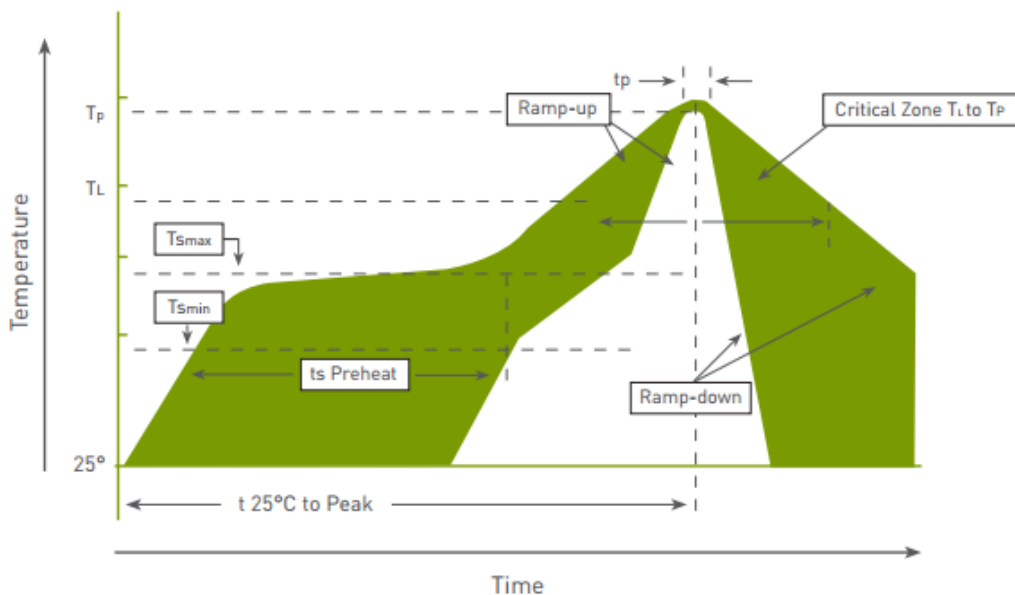

Temperature profile – (green area) for the assembly process in reflow ovens

## 9. Packaging (Units: mm)

450 pc PA.25.A  
 1 reel per small inner box  
 Dimensions - 330\*55mm  
 Weight - 2000g

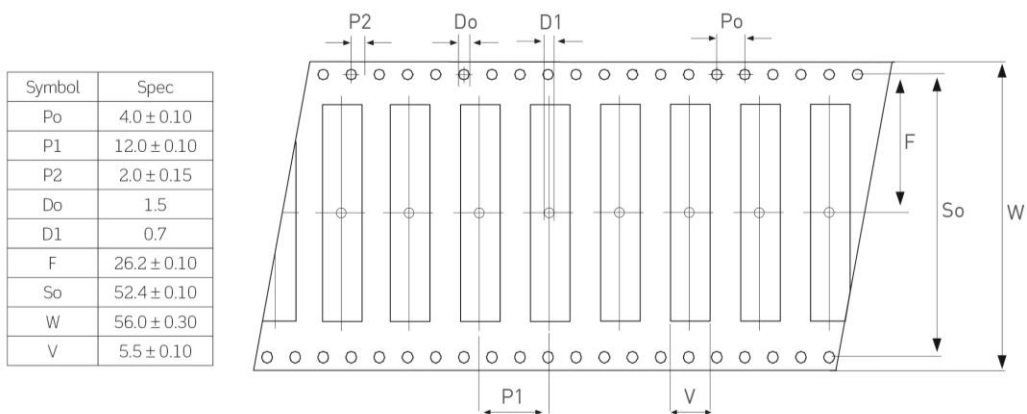
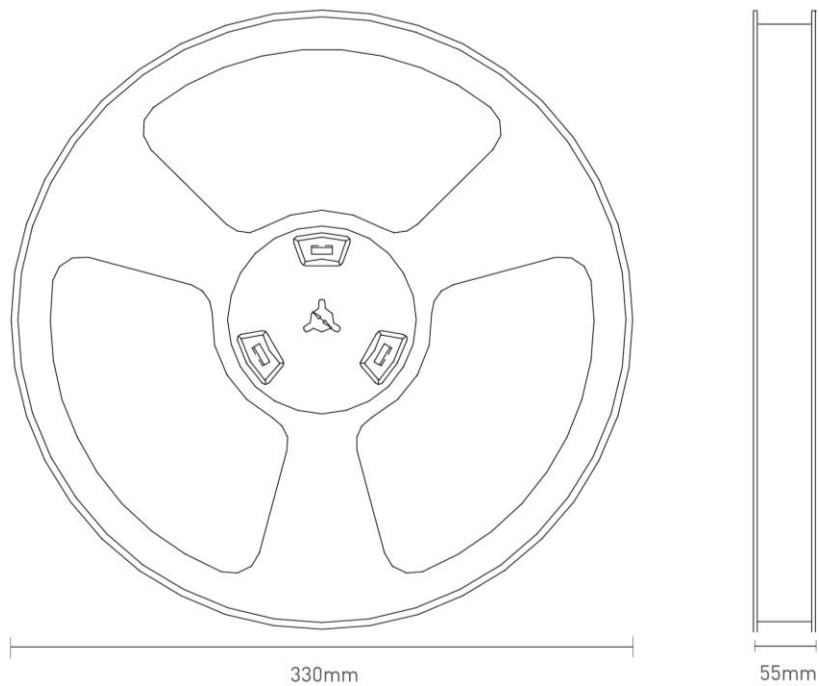



450 pc PA.25.A  
 1 reel in small inner box  
 Dimensions - 350\*350\*70  
 Weight - 2.2Kg

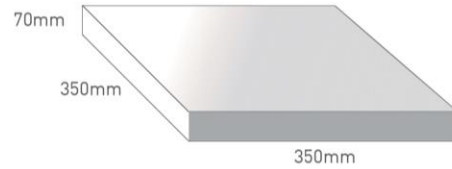

3 boxes / 1350 pcs in one carton  
 Carton Dimensions - 370\*360\*275mm  
 Weight -7.3Kg

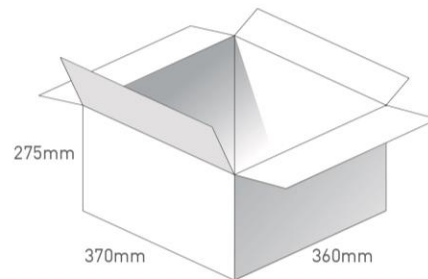

Pallet Dimensions 1200\*1000\*1320mm  
 24 Cartons per Pallet  
 6 Cartons per layer  
 4 Layers

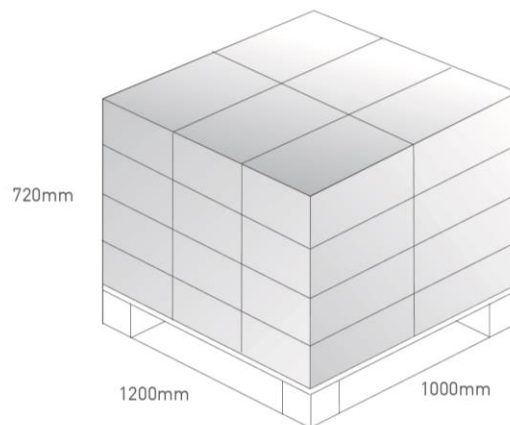

Taoglas makes no warranties based on the accuracy or completeness of the contents of this document and reserves the right to make changes to specifications and product descriptions at any time without notice. Taoglas reserves all rights to this document and the information contained herein.

Reproduction, use or disclosure to third parties without express permission is strictly prohibited.

Copyright © Taoglas Ltd.