

## Dual 250 mA Output, UltraLow Noise, High PSRR, Low-Dropout Linear Regulator with Integrated SVS

### FEATURES

- Dual 250 mA High-Performance RF LDOs
- Integrated Supply Voltage Supervisor Monitors  $V_{OUT2}$
- Available in Fixed and Adjustable Voltage Options (1.2 V to 5.5 V)
- High PSRR: 65 dB at 10 kHz
- UltraLow Noise: 32  $\mu\text{Vrms}$
- Fast Start-Up Time: 60  $\mu\text{s}$
- Stable with 2.2  $\mu\text{F}$  Ceramic Capacitor
- Excellent Load/Line Transient Response
- Very Low Dropout Voltage: 125 mV at 250 mA
- Independent Enable Pins
- Thermal Shutdown and Independent Current Limit
- Available in Thermally-Enhanced SON Package: 3mm x 3mm x 1mm

### APPLICATIONS

- Cellular and Cordless Phones
- Wireless PDA/Handheld Products
- PCMCIA/Wireless LAN Applications
- Digital Camera/Camcorder/Internet Audio
- DSP/FPGA/ASIC/Controllers and Processors

### DESCRIPTION

The TPS713xx family of low-dropout (LDO) voltage regulators is tailored to noise-sensitive and RF applications. These products feature dual 250 mA LDOs with ultralow noise, high power-supply rejection ratio (PSRR), and fast transient and start-up response. These devices also feature an integrated supply voltage supervisor (SVS) that monitors the voltage at OUT2 and will assert if the voltage falls to 95% (typical) of the measured output. Each regulator output is stable with low-cost 2.2  $\mu\text{F}$  ceramic output capacitors and features very low dropout voltages (125 mV typical at 250 mA). Each regulator achieves fast start-up times (approximately 60  $\mu\text{s}$  with a 0.001  $\mu\text{F}$  bypass capacitor) while consuming very low quiescent current (300  $\mu\text{A}$  typical with both outputs enabled). When the device is placed in standby mode, the supply current is reduced to less than 0.3  $\mu\text{A}$  typical. Each regulator exhibits approximately 32  $\mu\text{Vrms}$  of output voltage noise with  $V_{OUT} = 2.8 \text{ V}$  and a 0.01  $\mu\text{F}$  noise reduction (NR) capacitor. Applications with analog components that are noise-sensitive, such as portable RF electronics, will benefit from high PSRR, low noise, and fast line and load transient features. The TPS713xx family is offered in a thin 3mm x 3mm SON package and is fully specified from  $-40^\circ\text{C}$  to  $+125^\circ\text{C}$  ( $T_J$ ).

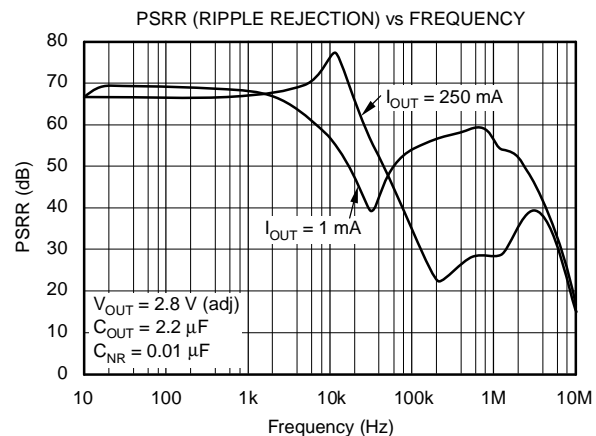
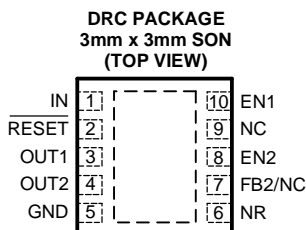

Please be aware that an important notice concerning availability, standard warranty, and use in critical applications of Texas Instruments semiconductor products and disclaimers thereto appears at the end of this data sheet.



This integrated circuit can be damaged by ESD. Texas Instruments recommends that all integrated circuits be handled with appropriate precautions. Failure to observe proper handling and installation procedures can cause damage.

ESD damage can range from subtle performance degradation to complete device failure. Precision integrated circuits may be more susceptible to damage because very small parametric changes could cause the device not to meet its published specifications.

### ORDERING INFORMATION<sup>(1)</sup>

PRODUCT	VOLTAGE (T <sub>J</sub> )		PACKAGE-LEAD (DESIGNATOR)	SPECIFIED TEMPERATURE RANGE (T <sub>J</sub> )	PACKAGE MARKING	ORDERING NUMBER	TRANSPORT MEDIA, QUANTITY
	V <sub>OUT1</sub>	V <sub>OUT2</sub>					
TPS71319	1.8 V	Adjustable	SON-10 (DRC)	-40°C to +125°C	ARP	TPS71319DRCT	Tape and Reel, 250
						TPS71319DRCR	Tape and Reel, 3000
TPS71334	3.3 V	Adjustable	SON-10 (DRC)	-40°C to +125°C	ARO	TPS71334DRCT	Tape and Reel, 250
						TPS71334DRCR	Tape and Reel, 3000

(1) For the most current package and ordering information, see the Package Ordering Addendum located at the end of this data sheet.

### ABSOLUTE MAXIMUM RATINGS

over operating junction temperature range unless otherwise noted<sup>(1)</sup>

	TPS713xx	UNIT
V <sub>IN</sub> range	-0.3 to 6.0	V
V <sub>RESET</sub> range	-0.3 to V <sub>IN</sub> + 0.3	V
V <sub>EN1</sub> , V <sub>EN2</sub> range	-0.3 to V <sub>IN</sub> + 0.3	V
V <sub>OUT</sub> range	-0.3 to 6.0	V
Peak output current	Internally limited	
Output short-circuit duration	Indefinite	
Continuous total power dissipation	See Dissipation Ratings Table	
Junction temperature range, T <sub>J</sub>	-40 to +150	°C
Storage temperature range	-65 to +150	°C
ESD rating, HBM	2	kV
ESD rating, CDM	500	V

(1) Stresses beyond those listed under *absolute maximum ratings* may cause permanent damage to the device. These are stress ratings only, and functional operation of the device at these or any other conditions beyond those indicated under the Electrical Characteristics is not implied. Exposure to absolute maximum rated conditions for extended periods may affect device reliability.

### POWER DISSIPATION RATINGS

BOARD	PACKAGE	R <sub>θJC</sub>	R <sub>θJA</sub>	DERATING FACTOR ABOVE T <sub>A</sub> = 25°C	T <sub>A</sub> ≤ 25°C POWER RATING	T <sub>A</sub> = 70°C POWER RATING	T <sub>A</sub> = 85°C POWER RATING
High-K <sup>(1)</sup>	DRC	48	52	19 mW/°C	1.92 W	1.06 W	0.77 W

(1) The JEDEC High-K (2s2p) board design used to derive this data was a 3 inch x 3 inch, multilayer board with 1-ounce internal power and ground planes and 2-ounce copper traces on the top and bottom of the board.

## ELECTRICAL CHARACTERISTICS

Over operating temperature range ( $T_J = -40^\circ\text{C}$  to  $+125^\circ\text{C}$ ),  $V_{IN}$  = highest  $V_{OUT(nom)}$  + 1.0 V or 2.7 V (whichever is greater),  $I_{OUT} = 1$  mA,  $V_{EN1,2} = 1.2$  V,  $C_{OUT} = 10$   $\mu\text{F}$ ,  $C_{NR} = 0.01$   $\mu\text{F}$ , and adjustable LDOs are tested at  $V_{OUT} = 3.0$  V, unless otherwise noted. Typical values are at  $T_J = 25^\circ\text{C}$ .

PARAMETER		TEST CONDITIONS	MIN	TYP	MAX	UNIT	
$V_{IN}$	Input voltage range <sup>(1)</sup>		2.7		5.5	V	
$V_{FB}$	Internal reference (adjustable LDOs)		1.200	1.225	1.250	V	
$V_{OUT}$	Output voltage range (adjustable LDOs)		$V_{FB}$	5.5 - $V_{DO}$		V	
	Accuracy <sup>(1)</sup>	Nominal	$T_J = 25^\circ\text{C}$ , $I_{OUT} = 0$ mA		-1.5	+1.5	%
Over $V_{IN}$ , $I_{OUT}$ , and T		$V_{OUT} + 1.0 \text{ V} \leq V_{IN} \leq 5.5 \text{ V}$ , $0 \mu\text{A} \leq I_{OUT} \leq 250 \text{ mA}$		-3	$\pm 1$	+3	
$\Delta V_{OUT}/\Delta V_{IN}$	Line regulation <sup>(1)</sup>	$V_{OUT} + 1.0 \text{ V} \leq V_{IN} \leq 5.5 \text{ V}$		0.05		%/V	
$\Delta V_{OUT}/\Delta I_{OUT}$	Load regulation	$0 \mu\text{A} \leq I_{OUT} \leq 250 \text{ mA}$		0.8		%/mA	
$V_{DO}$	Dropout voltage <sup>(2)</sup> ( $V_{IN} = V_{OUT(nom)} - 0.1\text{V}$ )	2.8 V, 2.85 V Adjustable	$I_{OUT1} = I_{OUT2} = 250 \text{ mA}$		125	230	mV
$I_{CL}$	Output current limit	$V_{OUT} = 0.9 \times V_{OUT(nom)}$		400	600	800	mA
$I_{GND}$	Ground pin current	One LDO enabled	$I_{OUT} = 1$ mA (enabled channel)		190	250	$\mu\text{A}$
		Both LDOs enabled	$I_{OUT1} = I_{OUT2} = 1$ mA to 250 mA		300	600	
$I_{SHDN}$	Shutdown current <sup>(3)</sup>	$V_{EN} \leq 0.4 \text{ V}$ , $0 \text{ V} \leq V_{IN} \leq 5.5 \text{ V}$ , <b>RESET</b> open		0.3	2.0	$\mu\text{A}$	
$I_{FB}$	FB pin current (adjustable LDOs)			0.1	1	$\mu\text{A}$	
$V_n$	Output noise voltage, BW = 10 Hz - 100 kHz	No $C_{NR}$ , $I_{OUT} = 250$ mA		$80.0 \times V_{OUT}$		$\mu\text{V}_{rms}$	
		$C_{NR} = 0.01$ $\mu\text{F}$ , $I_{OUT} = 250$ mA		$11.8 \times V_{OUT}$			
PSRR	Power-supply rejection ratio (ripple rejection)	$f = 100$ Hz, $I_{OUT} = 250$ mA		65		dB	
		$f = 10$ kHz, $I_{OUT} = 250$ mA		65			
$t_{STR}$	Startup time	$V_{OUT} = 2.85 \text{ V}$ , $R_L = 30\Omega$ , $C_{NR} = 0.001$ $\mu\text{F}$		60		$\mu\text{s}$	
$V_{IH}$	Enable threshold high (EN1, EN2)			1.2	$V_{IN}$	V	
$V_{IL}$	Enable threshold low (EN1, EN2)			0	0.4	V	
$I_{EN}$	Enable pin current (EN1, EN2)	$V_{IN} = V_{EN} = 5.5 \text{ V}$		-1	1	$\mu\text{A}$	
	Minimum $V_{IN}$ for valid <b>RESET</b>	$I_{RESET} = 10$ $\mu\text{A}$		0.6		V	
$V_{RESET, LO}$	<b>RESET</b> output low voltage	$I_{RESET} = 1$ mA			0.4	V	
$I_{LKG, RESET}$	<b>RESET</b> leakage current	$V_{IN} = V_{RESET} = 5.5 \text{ V}$		10	500	nA	
$V_{IT}$	<b>RESET</b> threshold voltage	$V_{OUT2}$ falling <sup>(4)</sup>		92.5	97.5	% $V_{OUT}$	
$V_{HYS}$	<b>RESET</b> threshold hysteresis	$V_{OUT2}$ rising <sup>(4)</sup>		0.5		% $V_{OUT}$	
$T_D$	<b>RESET</b> delay time			50	100	200	ms
$T_P$	<b>RESET</b> propagation delay			10		$\mu\text{s}$	
$T_{SD}$	Thermal shutdown temperature	Shutdown	Temp increasing		+160	$^\circ\text{C}$	
		Reset	Temp decreasing		+140		
UVLO	Under-voltage lockout threshold	$V_{IN}$ rising		2.25	2.65	V	
	Under-voltage lockout hysteresis	$V_{IN}$ falling		100		mV	

(1) Minimum  $V_{IN} = V_{OUT} + V_{DO}$  or 2.7 V, whichever is greater.

(2)  $V_{DO}$  is not measured for 1.8 V regulators since minimum  $V_{IN} = 2.7$  V.

(3) For the adjustable version, this applies only after  $V_{IN}$  is applied; then  $V_{EN}$  transitions from high to low.

(4) **RESET** threshold and hysteresis is a percentage of the measured output.

FUNCTIONAL BLOCK DIAGRAM

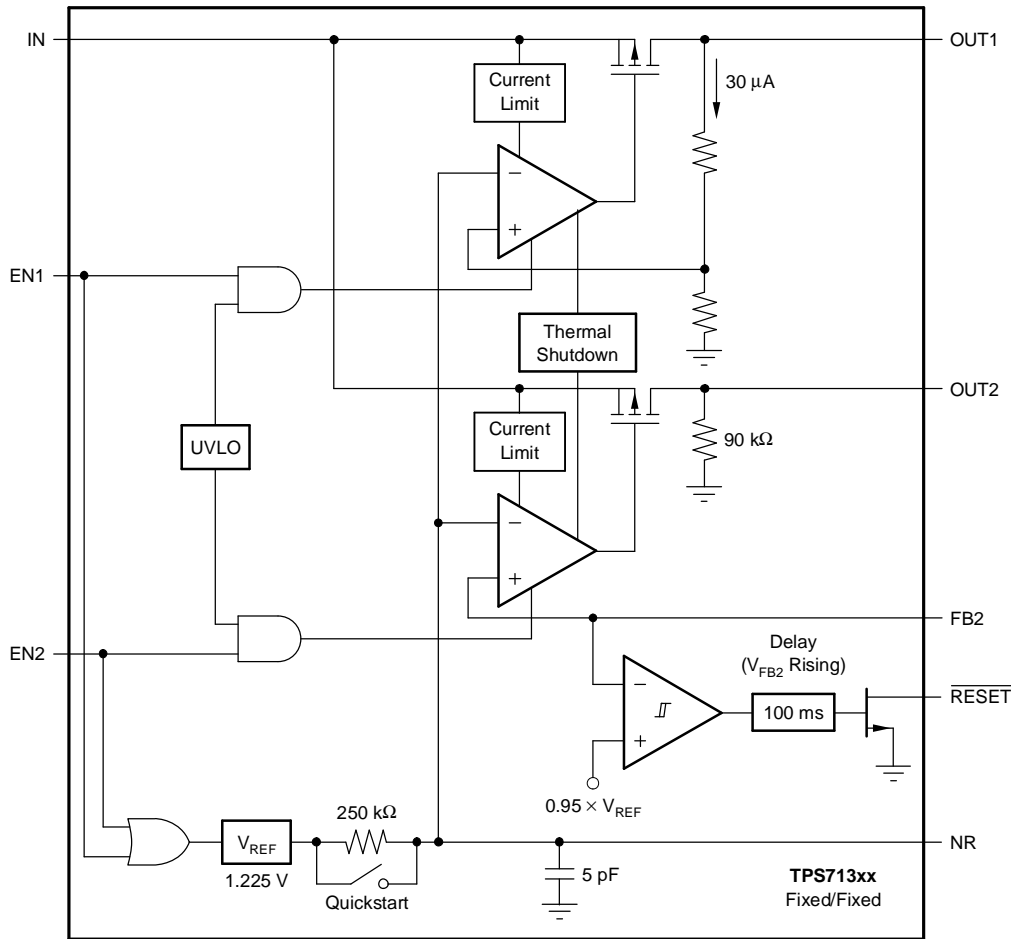

Table 1. TERMINAL FUNCTIONS

TERMINAL		DESCRIPTION
NAME	DRC	
IN	1	Unregulated input supply. A 0.1 μF capacitor should be connected from IN to GND.
GND	5, Pad	Ground
OUT1	3	Output of the regulator. A small 2.2 μF ceramic capacitor is required from this pin to ground to assure stability.
OUT2	4	Same as OUT1 but for LDO2.
EN1	10	Driving the enable pin (EN) high turns on LDO1. Driving this pin low puts LDO1 into shutdown mode, reducing operating current. The enable pin should be connected to IN if not used.
EN2	8	Same as EN1 but controls LDO2.
NC	9	No connection.
FB2/NC	7	Feedback for CH2 adjustable version; no connection for non-adjustable CH2.
NR	6	Noise reduction pin; connect an external bypass capacitor to reduce LDO output noise.
RESET	2	Open-drain reset output; monitors OUT2. A 10 kΩ to 1 MΩ pull-up resistor is suitable for most applications. The open-drain RESET pull-up voltage should not exceed V <sub>DD</sub> + 0.3 V.

### TYPICAL CHARACTERISTICS

For all voltage versions at  $T_J = 25^\circ\text{C}$ ,  $V_{IN} = V_{OUT(nom)} + 1\text{ V}$ ,  $I_{OUT} = 1\text{ mA}$ ,  $V_{EN} = 1.2\text{ V}$ ,  $C_{OUT} = 2.2\text{ }\mu\text{F}$ , and  $C_{NR} = 0.01\text{ }\mu\text{F}$ , unless otherwise noted.

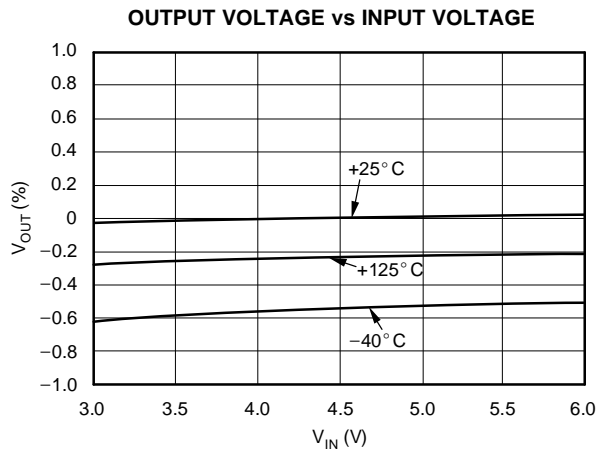

Figure 1.

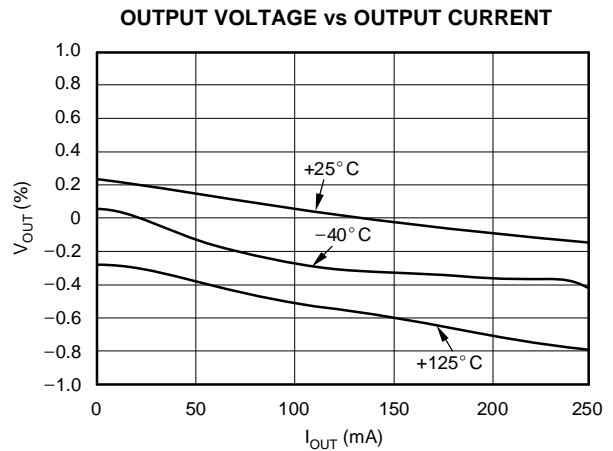

Figure 2.

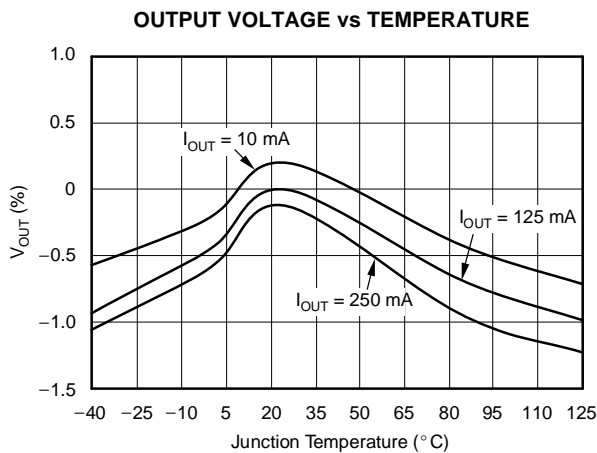

Figure 3.

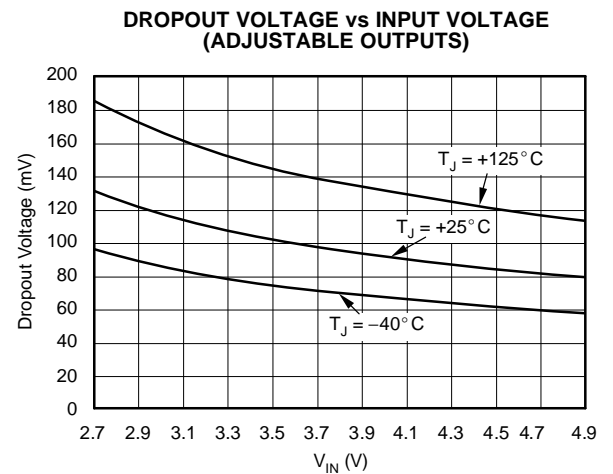

Figure 4.

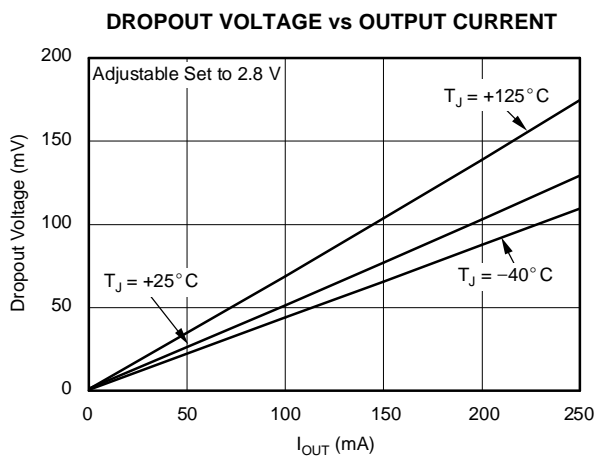

Figure 5.

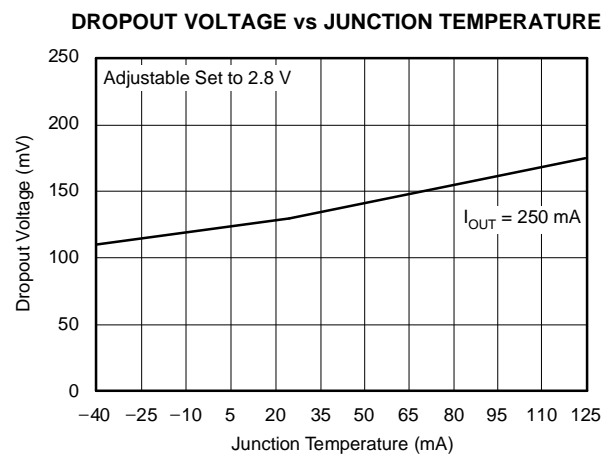

Figure 6.

**TYPICAL CHARACTERISTICS (continued)**

For all voltage versions at  $T_J = 25^\circ\text{C}$ ,  $V_{IN} = V_{OUT(nom)} + 1\text{ V}$ ,  $I_{OUT} = 1\text{ mA}$ ,  $V_{EN} = 1.2\text{ V}$ ,  $C_{OUT} = 2.2\text{ }\mu\text{F}$ , and  $C_{NR} = 0.01\text{ }\mu\text{F}$ , unless otherwise noted.

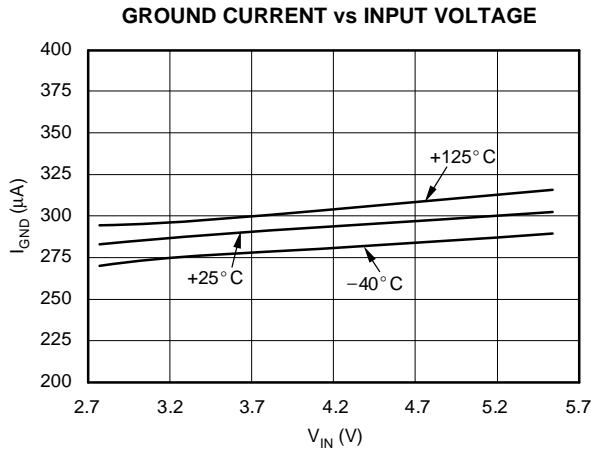

Figure 7.

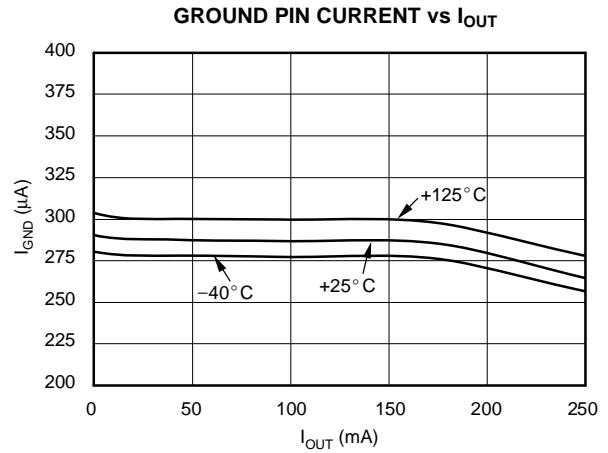

Figure 8.

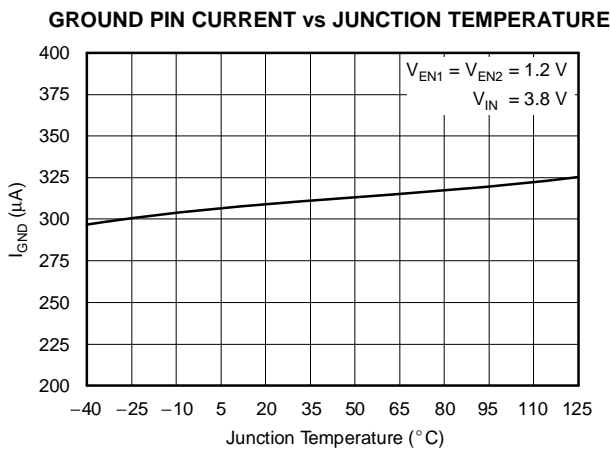

Figure 9.

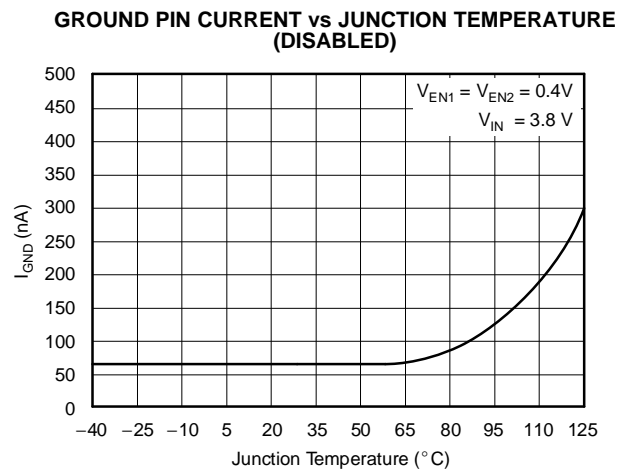

Figure 10.

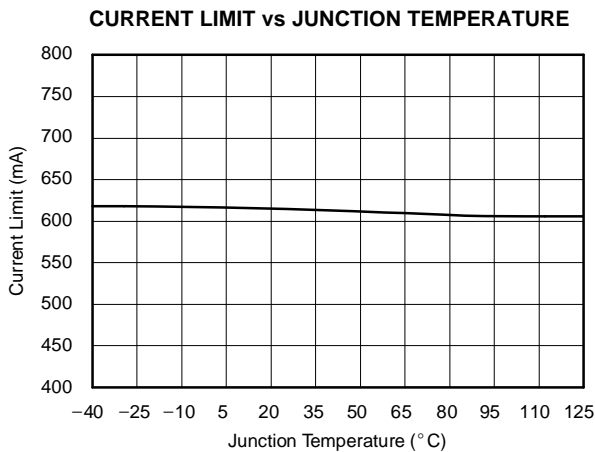

Figure 11.

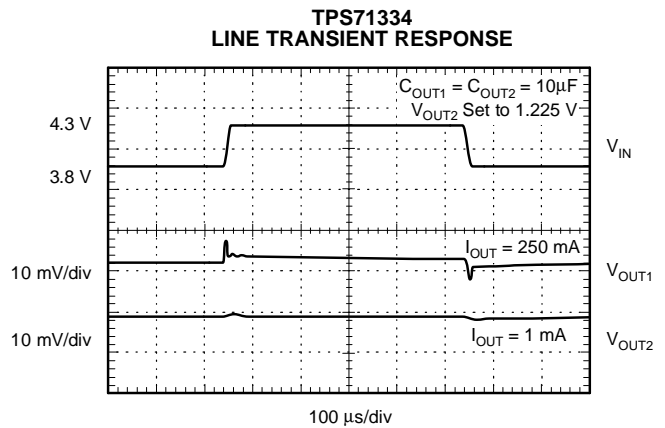

Figure 12.

## TYPICAL CHARACTERISTICS (continued)

For all voltage versions at  $T_J = 25^\circ\text{C}$ ,  $V_{IN} = V_{OUT(nom)} + 1\text{ V}$ ,  $I_{OUT} = 1\text{ mA}$ ,  $V_{EN} = 1.2\text{ V}$ ,  $C_{OUT} = 2.2\text{ }\mu\text{F}$ , and  $C_{NR} = 0.01\text{ }\mu\text{F}$ , unless otherwise noted.

TPS71334  
LOAD TRANSIENT RESPONSE  
AND  $V_{OUT2}$  CROSSTALK

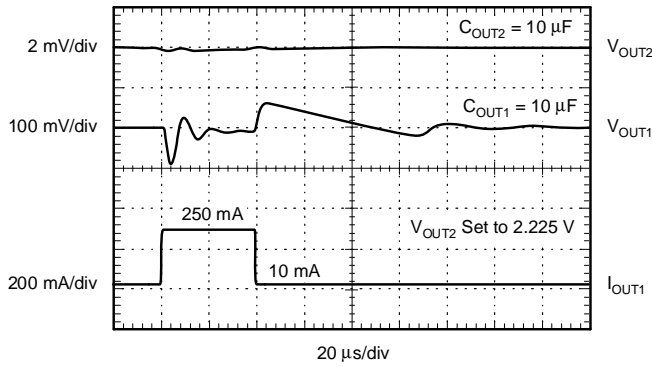

Figure 13.

TPS71334  
CHANNEL-TO-CHANNEL ISOLATION vs FREQUENCY

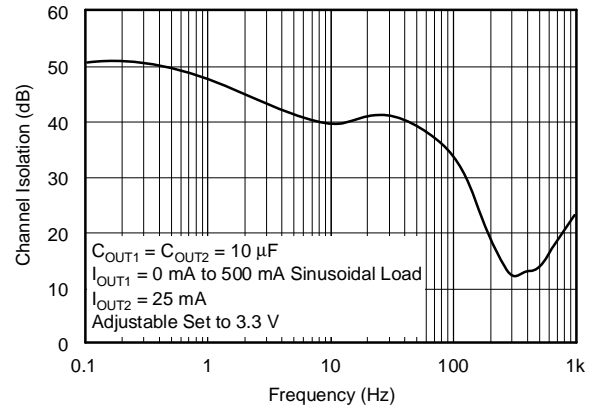

Figure 14.

TPS71334  
TURN-ON/OFF RESPONSE  
AND  $V_{OUT2}$  CROSSTALK

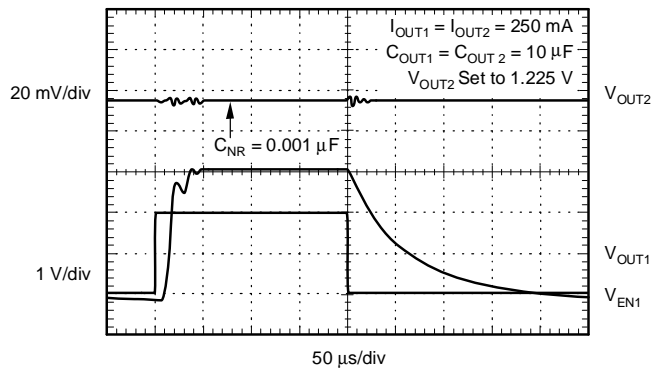

Figure 15.

TPS71334  
POWER-UP/POWER-DOWN

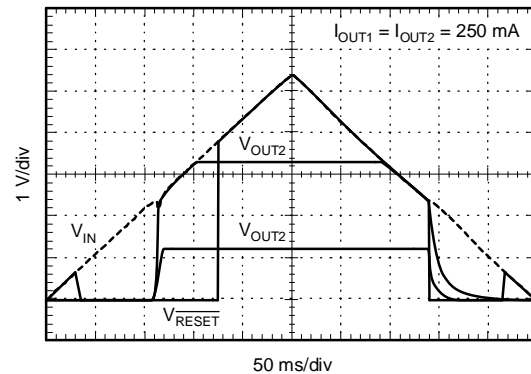

Figure 16.

TOTAL NOISE vs  $C_{NR}$

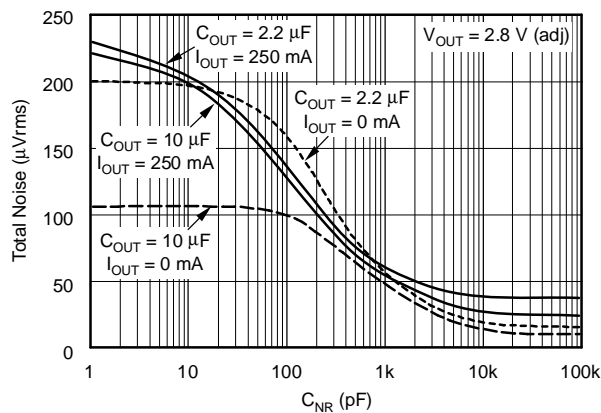

Figure 17.

NOISE SPECTRAL DENSITY  
 $C_{OUT} = 2.2\text{ }\mu\text{F}$

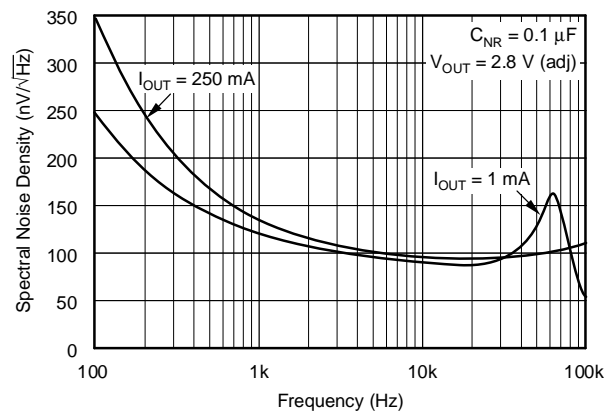

Figure 18.

**TYPICAL CHARACTERISTICS (continued)**

For all voltage versions at  $T_J = 25^\circ\text{C}$ ,  $V_{IN} = V_{OUT(nom)} + 1\text{ V}$ ,  $I_{OUT} = 1\text{ mA}$ ,  $V_{EN} = 1.2\text{ V}$ ,  $C_{OUT} = 2.2\text{ }\mu\text{F}$ , and  $C_{NR} = 0.01\text{ }\mu\text{F}$ , unless otherwise noted.

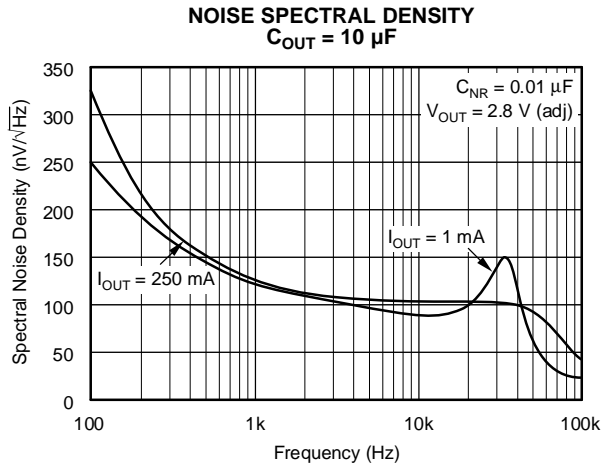

Figure 19.

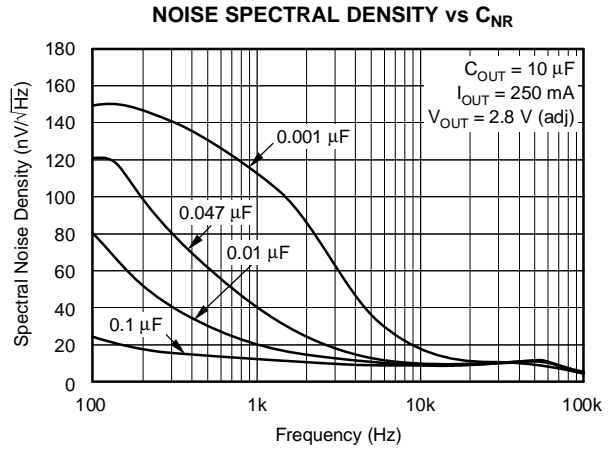

Figure 20.

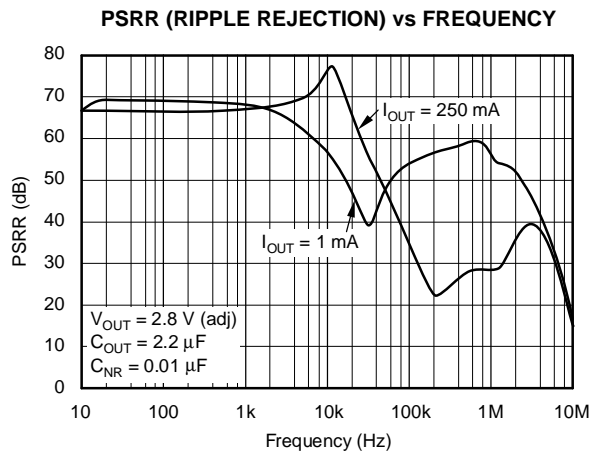

Figure 21.

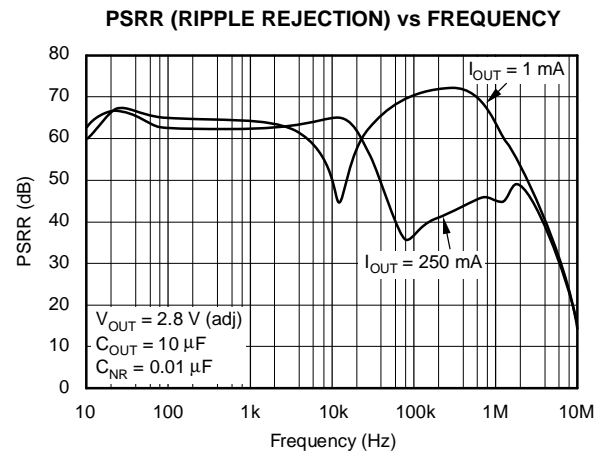

Figure 22.

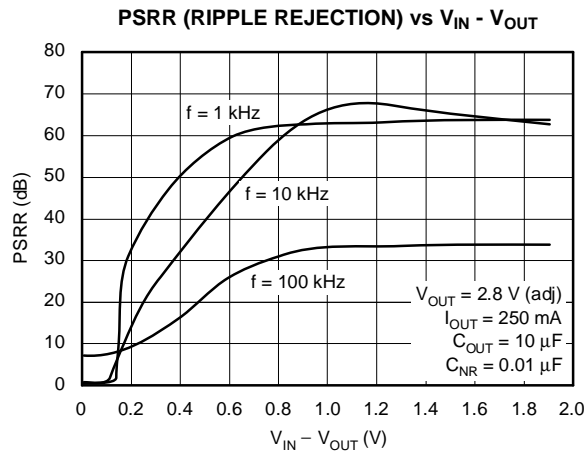
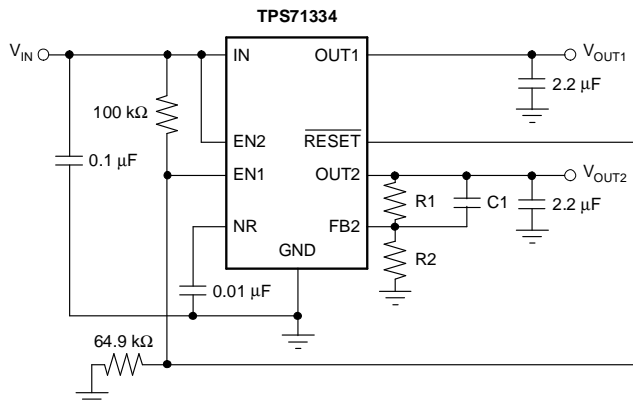

Figure 23.



## APPLICATION INFORMATION

The TPS713xx family of dual low-dropout (LDO) regulators has been optimized for use in noise-sensitive battery-operated equipment. The device features extremely low dropout, high PSRR, ultralow output noise, and low quiescent current (190  $\mu\text{A}$  typically per channel). When both outputs are disabled, the supply currents are reduced to less than 2  $\mu\text{A}$ . A typical application circuit with sequencing is shown in Figure 24.



**Figure 24. Typical Application Circuit (with output sequencing)**

### INPUT AND OUTPUT CAPACITOR REQUIREMENTS

A 0.1  $\mu\text{F}$  or larger ceramic input bypass capacitor, connected between IN and GND and located close to the TPS713xx, is required for stability. It improves transient response, noise rejection, and ripple rejection. A higher-value input capacitor may be necessary if large, fast-rise-time load transients are anticipated and the device is located several inches from the power source.

The TPS713xx requires an output capacitor connected between the outputs and GND to stabilize the internal control loops. The minimum recommended output capacitor is 2.2  $\mu\text{F}$ . If an output voltage of

1.8 V or less is chosen, the minimum recommended output capacitor is 4.7  $\mu\text{F}$ . Any ceramic capacitor that meets the minimum output capacitor requirements is suitable. Capacitors with higher ESR may be used, provided the worst-case ESR is less than 1  $\Omega$ .

### OUTPUT NOISE

The internal voltage reference is a key source of noise in an LDO regulator. The TPS713xx has an NR pin that is connected to the voltage reference through a 250 k $\Omega$  internal resistor. The 250 k $\Omega$  internal resistor, in conjunction with an external ceramic bypass capacitor connected to the NR pin, creates a low-pass filter to reduce the voltage reference noise and, therefore, the noise at the regulator output. To achieve a fast startup, the 250 k $\Omega$  internal resistor is shorted for 400  $\mu\text{s}$  after the device is enabled.

Because the primary noise source is the internal voltage reference, the output noise will be greater for higher output voltage versions. For the case where no noise reduction capacitor is used, the typical noise ( $\mu\text{Vrms}$ ) over 10 Hz to 100 kHz is 30 times the output voltage. If a 0.01  $\mu\text{F}$  capacitor is used from the NR pin to ground, the noise ( $\mu\text{Vrms}$ ) drops to 11.8 times the output voltage. For example, the TPS71334 with the adjustable output set to 2.8 V exhibits only 33  $\mu\text{Vrms}$  of output voltage noise using a 0.01  $\mu\text{F}$  ceramic bypass capacitor and a 2.2  $\mu\text{F}$  ceramic output capacitor.

### STARTUP CHARACTERISTICS

To minimize startup overshoot, the TPS713xx will initially target an output voltage that is approximately 80% of the final value. To avoid a delayed startup time, noise reduction capacitors of 0.01  $\mu\text{F}$  or less are recommended. Larger noise reduction capacitors will cause the output to hold at 80% until the voltage on the noise reduction capacitor exceeds 80% of the bandgap voltage. The typical startup time with a 0.001  $\mu\text{F}$  noise reduction capacitor is 60  $\mu\text{s}$ . Once one of the output voltages is present, the startup time of the other output will not be affected by the noise reduction capacitor.

## PROGRAMMING THE TPS71202 ADJUSTABLE LDO REGULATOR

The output voltage of the TPS71202 dual adjustable regulator is programmed using an external resistor divider, as shown in Figure 24. The output voltage is calculated using Equation 1:

$$V_{OUT} = V_{REF} \times \left(1 + \frac{R1}{R2}\right) \quad (1)$$

where  $V_{REF} = 1.225$  V (the internal reference voltage).

Resistors R2 and R4 should be chosen for approximately a 40  $\mu$ A divider current. Lower value resistors can be used for improved noise performance, but will consume more power. Higher values should be avoided because leakage current at FB increases the output voltage error. The recommended design procedure is to choose R2 = 30.1 k $\Omega$  to set the divider current at 40  $\mu$ A, and then calculate R1 using Equation 2:

$$R1 = \left(\frac{V_{OUT}}{V_{REF}} - 1\right) \times R2 \quad (2)$$

To improve the stability and noise performance of the adjustable version, a small compensation capacitor can be placed between OUT and FB.

For voltages  $\leq 1.8$  V, the value of this capacitor should be 100 pF. For voltages  $> 1.8$  V, the approximate value of this capacitor can be calculated as Equation 3:

$$C1 = \frac{(3 \times 10^5) \times (R1 + R2)}{(R1 \times R2)} \text{ (pF)} \quad (3)$$

The suggested value of this capacitor for several resistor ratios is shown in Figure 25. If this capacitor is not used (such as in a unity-gain configuration) or if an output voltage  $\leq 1.8$  V is chosen, then the minimum recommended output capacitor is 4.7  $\mu$ F instead of 2.2  $\mu$ F.

## DROPOUT VOLTAGE

The TPS713xx uses a PMOS pass transistor to achieve extremely low dropout. When  $(V_{IN} - V_{OUT})$  is less than the dropout voltage ( $V_{DO}$ ), the PMOS pass device is in its linear region of operation and the input-to-output resistance is the  $R_{DS, ON}$  of the PMOS pass element. Dropout voltages at lower currents can be approximated by calculating the effective  $R_{DS, ON}$  of the pass element and multiplying that resistance by the load current.  $R_{DS, ON}$  of the pass element can be obtained by dividing the dropout voltage by the rated output current. For the TPS71334, the  $R_{DS, ON}$  of the pass element is 84 m $\Omega$ . The dropout voltage of the TPS713xx will be less for higher output voltage versions. This is because the PMOS pass element will have lower on-resistance due to increased gate drive.

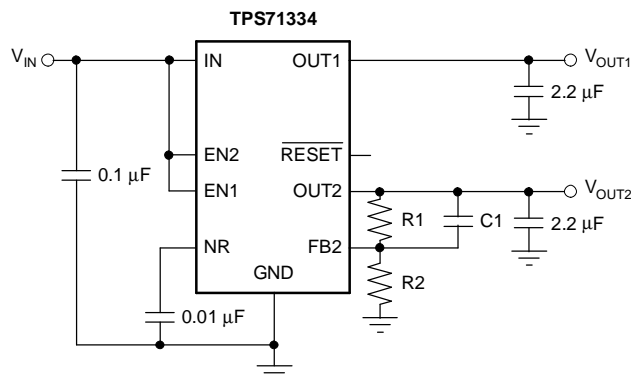

Output Voltage Programming Guide

V <sub>OUT2</sub>	R1	R2	C1
1.225 V	Short	Open	Open
1.5 V	7.15 k $\Omega$	30.1 k $\Omega$	100 pF
2.5 V	31.6 k $\Omega$	30.1 k $\Omega$	22 pF
3.0 V	43.2 k $\Omega$	30.1 k $\Omega$	15 pF
3.3 V	49.9 k $\Omega$	30.1 k $\Omega$	15 pF
4.75 V	86.6 k $\Omega$	30.1 k $\Omega$	15 pF

Figure 25. TPS71334 Adjustable LDO Regulator Programming

## SUPERVISOR DESCRIPTION

The TPS713xx has an on-chip supply voltage supervisor (SVS) that monitors the voltage at OUT2. The  $\overline{\text{RESET}}$  output will assert if  $V_{\text{OUT2}}$  is below the reset threshold ( $V_{\text{IT}}$ ). When OUT2 exceeds the reset threshold plus hysteresis ( $V_{\text{HYS}}$ ), the  $\overline{\text{RESET}}$  output will remain low for the specified delay time ( $t_{\text{D}}$ ). When OUT2 is disabled by EN2 or the input voltage is below the under-voltage lockout (UVLO), the reset signal is automatically asserted. The functionality of the reset circuit is shown in Figure 26 and Table 2.

The output accuracy or output divider resistor tolerances have minimal effect on the relative  $V_{\text{IT}}$  threshold accuracy. The reset threshold  $V_{\text{IT}}$  will scale accordingly to the actual output voltage. The  $\overline{\text{RESET}}$

output will remain unasserted during transients shorter than the reset circuit propagation delay ( $T_{\text{P}}$ ). Even with a 2.2  $\mu\text{F}$  output capacitor, typical load transient conditions will not cause  $\overline{\text{RESET}}$  to falsely assert.

The  $\overline{\text{RESET}}$  pin requires an external resistor to pull the pin high during the unasserted state. A 10 k $\Omega$  to 1 M $\Omega$  resistor is suitable for most applications. If the resistance is too low, the pin may not pull low enough to be recognized as a valid logic signal. If the pull-up resistor is too large, the reset pin leakage may cause the device not to pull high enough in the unasserted state. The pull-up voltage for the  $\overline{\text{RESET}}$  pin should not exceed  $V_{\text{IN}} + 0.3 \text{ V}$ ; doing so will turn on internal ESD protection devices and may damage the device.

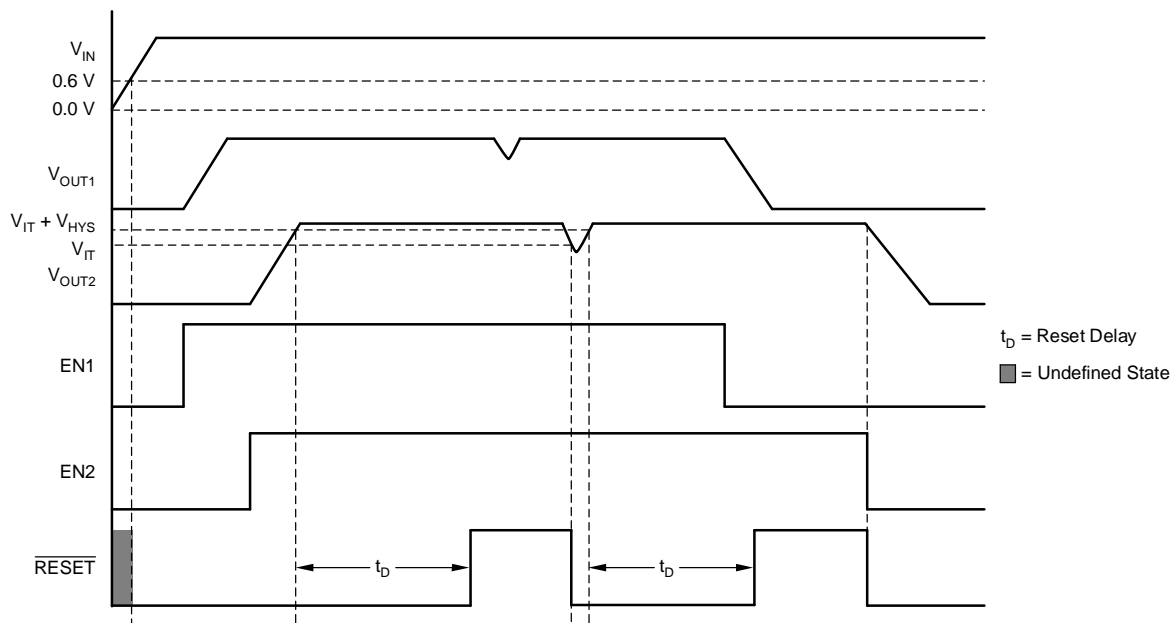

Figure 26.  $\overline{\text{RESET}}$  Timing Diagram

Table 2. Reset Pin Truth Table

EN2	UVLO Asserted	$V_{\text{OUT2}}$	$\overline{\text{RESET}}$ Asserted
X <sup>(1)</sup>	Yes	X	Yes
Low	X	X	Yes
High	No	$V_{\text{OUT2}} > V_{\text{IT}}$	No
High	No	$V_{\text{OUT2}} < V_{\text{IT}}$	Yes

(1) X = don't care.

## TRANSIENT RESPONSE

As with any regulator, increasing the size of the output capacitor will reduce over/undershoot magnitude but increase duration of the transient response. In the adjustable version, the addition of a capacitor,  $C_{FB}$ , from the output to the feedback pin will also improve stability and transient response. The transient response of the TPS713xx is enhanced with an active pull-down that engages when the output is over-voltaged. The active pull-down decreases the output recovery time when the load is removed. Figure 14 in the Typical Characteristics section shows the output transient response.

## SHUTDOWN

Both enable pins are active high and are compatible with standard TTL-CMOS levels. The device is only completely disabled when both EN1 and EN2 are logic low. In this state, the LDO is completely off and the ground pin current drops to approximately 100 nA. With one output disabled, the ground pin current is slightly greater than half the nominal value. When shutdown capability is not required, the enable pins should be connected to the input supply.

## INTERNAL CURRENT LIMIT

The TPS713xx internal current limit helps protect the regulator during fault conditions. During current limit, the output will source a fixed amount of current that is largely independent of the output voltage.

The TPS713xx PMOS-pass transistors have a built-in back diode that conducts reverse current when the input voltage drops below the output voltage (that is, during power-down). Current is conducted from the output to the input and is not internally limited. If extended reverse voltage operation is anticipated, external limiting may be appropriate.

## THERMAL PROTECTION

Thermal protection disables both outputs when the junction temperature of either channel rises to approximately +160°C, allowing the device to cool. When the junction temperature cools to approximately +140°C, the output circuitry is again enabled.

Depending on power dissipation, thermal resistance, and ambient temperature, the thermal protection circuit may cycle on and off. This limits the dissipation of the regulator, protecting it from damage due to overheating.

Any tendency to activate the thermal protection circuit indicates excessive power dissipation or an inadequate heatsink. For reliable operation, junction temperature should be limited to +125°C maximum. To estimate the margin of safety in a complete design (including heatsink), increase the ambient temperature until the thermal protection is triggered; use worst-case loads and signal conditions. For good reliability, thermal protection should trigger at least +35°C above the maximum expected ambient condition of your application. This produces a worst-case junction temperature of +125°C at the highest expected ambient temperature and worst-case load.

The internal protection circuitry of the TPS713xx was designed to protect against overload conditions. It was not intended to replace proper heatsinking. Continuously running the TPS713xx into thermal shutdown will degrade device reliability.

## POWER DISSIPATION

The ability to remove heat from the die is different for each package type, presenting different considerations in the PCB layout. The PCB area around the device that is free of other components moves the heat from the device to the ambient air. Performance data for a JEDEC high-K board is shown in the Dissipation Ratings table. Using heavier copper will increase the effectiveness in removing heat from the device. The addition of plated through-holes to heat-dissipating layers will also improve the heat-sink effectiveness.

Power dissipation depends on input voltage and load conditions. Power dissipation is equal to the product of the output current times the voltage drop across the output pass element ( $V_{IN}$  to  $V_{OUT}$ ):

$$P_D = (V_{IN} - V_{OUT}) \times I_{OUT} \quad (4)$$

Power dissipation can be minimized by using the lowest possible input voltage necessary to assure the required output voltage.

**PACKAGING INFORMATION**

Orderable Device	Status (1)	Package Type	Package Drawing	Pins	Package Qty	Eco Plan (2)	Lead/Ball Finish (6)	MSL Peak Temp (3)	Op Temp (°C)	Device Marking (4/5)	Samples
TPS71319DRCR	ACTIVE	VSON	DRC	10	3000	Green (RoHS & no Sb/Br)	NIPDAU	Level-2-260C-1 YEAR	-40 to 125	ARP	<a href="#">Samples</a>
TPS71319DRCT	ACTIVE	VSON	DRC	10	250	Green (RoHS & no Sb/Br)	NIPDAU	Level-2-260C-1 YEAR	-40 to 125	ARP	<a href="#">Samples</a>
TPS71334DRCR	ACTIVE	VSON	DRC	10	3000	Green (RoHS & no Sb/Br)	NIPDAU	Level-2-260C-1 YEAR	-40 to 125	ARO	<a href="#">Samples</a>
TPS71334DRCT	ACTIVE	VSON	DRC	10	250	Green (RoHS & no Sb/Br)	NIPDAU	Level-2-260C-1 YEAR	-40 to 125	ARO	<a href="#">Samples</a>

(1) The marketing status values are defined as follows:

**ACTIVE:** Product device recommended for new designs.

**LIFEBUY:** TI has announced that the device will be discontinued, and a lifetime-buy period is in effect.

**NRND:** Not recommended for new designs. Device is in production to support existing customers, but TI does not recommend using this part in a new design.

**PREVIEW:** Device has been announced but is not in production. Samples may or may not be available.

**OBSOLETE:** TI has discontinued the production of the device.

(2) **RoHS:** TI defines "RoHS" to mean semiconductor products that are compliant with the current EU RoHS requirements for all 10 RoHS substances, including the requirement that RoHS substance do not exceed 0.1% by weight in homogeneous materials. Where designed to be soldered at high temperatures, "RoHS" products are suitable for use in specified lead-free processes. TI may reference these types of products as "Pb-Free".

**RoHS Exempt:** TI defines "RoHS Exempt" to mean products that contain lead but are compliant with EU RoHS pursuant to a specific EU RoHS exemption.

**Green:** TI defines "Green" to mean the content of Chlorine (Cl) and Bromine (Br) based flame retardants meet JS709B low halogen requirements of <=1000ppm threshold. Antimony trioxide based flame retardants must also meet the <=1000ppm threshold requirement.

(3) MSL, Peak Temp. - The Moisture Sensitivity Level rating according to the JEDEC industry standard classifications, and peak solder temperature.

(4) There may be additional marking, which relates to the logo, the lot trace code information, or the environmental category on the device.

(5) Multiple Device Markings will be inside parentheses. Only one Device Marking contained in parentheses and separated by a "-" will appear on a device. If a line is indented then it is a continuation of the previous line and the two combined represent the entire Device Marking for that device.

(6) Lead/Ball Finish - Orderable Devices may have multiple material finish options. Finish options are separated by a vertical ruled line. Lead/Ball Finish values may wrap to two lines if the finish value exceeds the maximum column width.

**Important Information and Disclaimer:**The information provided on this page represents TI's knowledge and belief as of the date that it is provided. TI bases its knowledge and belief on information provided by third parties, and makes no representation or warranty as to the accuracy of such information. Efforts are underway to better integrate information from third parties. TI has taken and

continues to take reasonable steps to provide representative and accurate information but may not have conducted destructive testing or chemical analysis on incoming materials and chemicals. TI and TI suppliers consider certain information to be proprietary, and thus CAS numbers and other limited information may not be available for release.

In no event shall TI's liability arising out of such information exceed the total purchase price of the TI part(s) at issue in this document sold by TI to Customer on an annual basis.

**TAPE AND REEL INFORMATION**

**QUADRANT ASSIGNMENTS FOR PIN 1 ORIENTATION IN TAPE**

\*All dimensions are nominal

Device	Package Type	Package Drawing	Pins	SPQ	Reel Diameter (mm)	Reel Width W1 (mm)	A0 (mm)	B0 (mm)	K0 (mm)	P1 (mm)	W (mm)	Pin1 Quadrant
TPS71319DRCR	VSON	DRC	10	3000	330.0	12.4	3.3	3.3	1.1	8.0	12.0	Q2
TPS71319DRCT	VSON	DRC	10	250	180.0	12.4	3.3	3.3	1.1	8.0	12.0	Q2
TPS71334DRCR	VSON	DRC	10	3000	330.0	12.4	3.3	3.3	1.1	8.0	12.0	Q2
TPS71334DRCT	VSON	DRC	10	250	180.0	12.4	3.3	3.3	1.1	8.0	12.0	Q2

**TAPE AND REEL BOX DIMENSIONS**

\*All dimensions are nominal

Device	Package Type	Package Drawing	Pins	SPQ	Length (mm)	Width (mm)	Height (mm)
TPS71319DRCR	VSON	DRC	10	3000	367.0	367.0	35.0
TPS71319DRCT	VSON	DRC	10	250	210.0	185.0	35.0
TPS71334DRCR	VSON	DRC	10	3000	367.0	367.0	35.0
TPS71334DRCT	VSON	DRC	10	250	210.0	185.0	35.0



## GENERIC PACKAGE VIEW

DRC 10

VSON - 1 mm max height

PLASTIC SMALL OUTLINE - NO LEAD

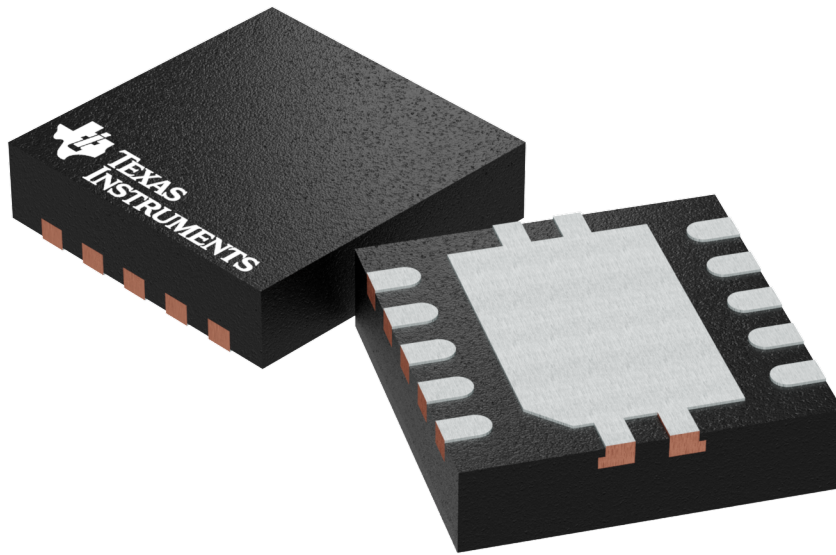

Images above are just a representation of the package family, actual package may vary.  
Refer to the product data sheet for package details.

4204102-3/M

# DRC0010K



# PACKAGE OUTLINE

VSON - 1 mm max height

PLASTIC SMALL OUTLINE - NO LEAD

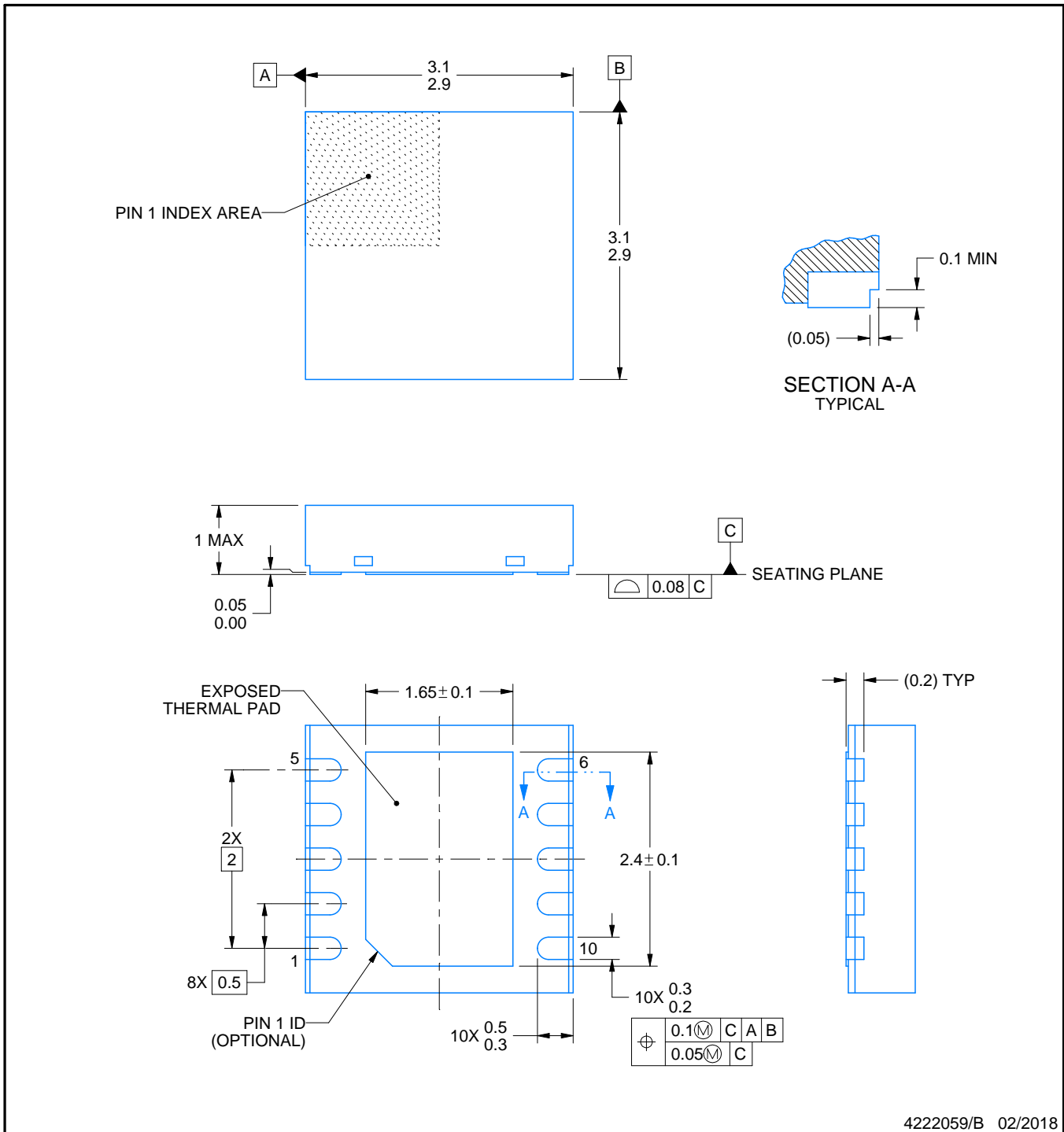

4222059/B 02/2018

**NOTES:**

1. All linear dimensions are in millimeters. Any dimensions in parenthesis are for reference only. Dimensioning and tolerancing per ASME Y14.5M.
2. This drawing is subject to change without notice.
3. The package thermal pad must be soldered to the printed circuit board for thermal and mechanical performance.

# EXAMPLE BOARD LAYOUT

DRC0010K

VSON - 1 mm max height

PLASTIC SMALL OUTLINE - NO LEAD

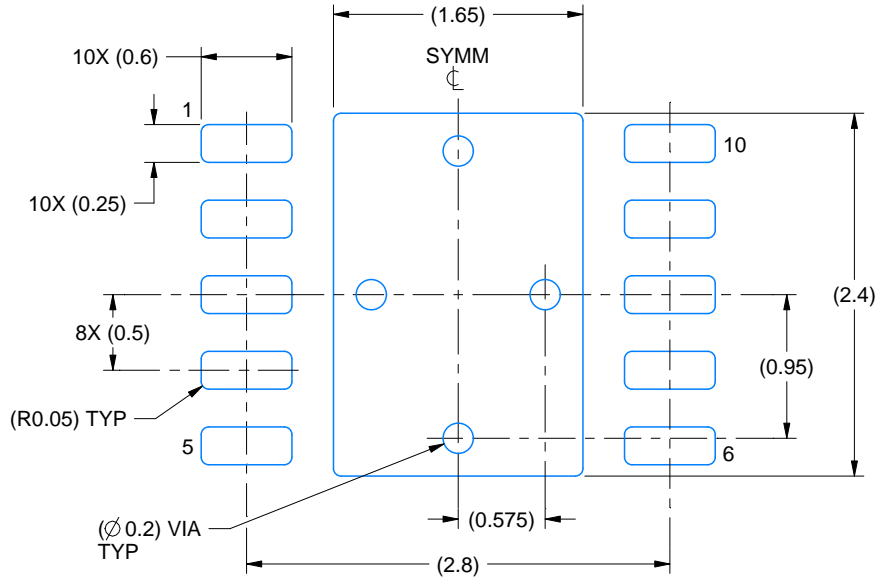

LAND PATTERN EXAMPLE  
EXPOSED METAL SHOWN  
SCALE:20X

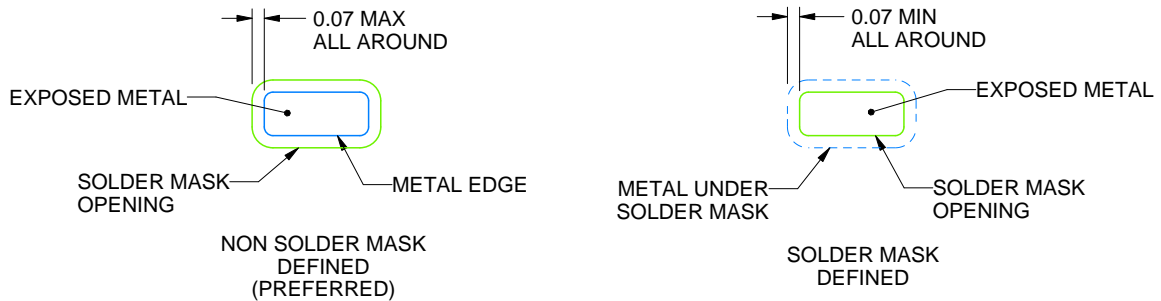

SOLDER MASK DETAILS

4222059/B 02/2018

NOTES: (continued)

4. This package is designed to be soldered to a thermal pad on the board. For more information, see Texas Instruments literature number SLUA271 ([www.ti.com/lit/slua271](http://www.ti.com/lit/slua271)).

# EXAMPLE STENCIL DESIGN

DRC0010K

VSON - 1 mm max height

PLASTIC SMALL OUTLINE - NO LEAD

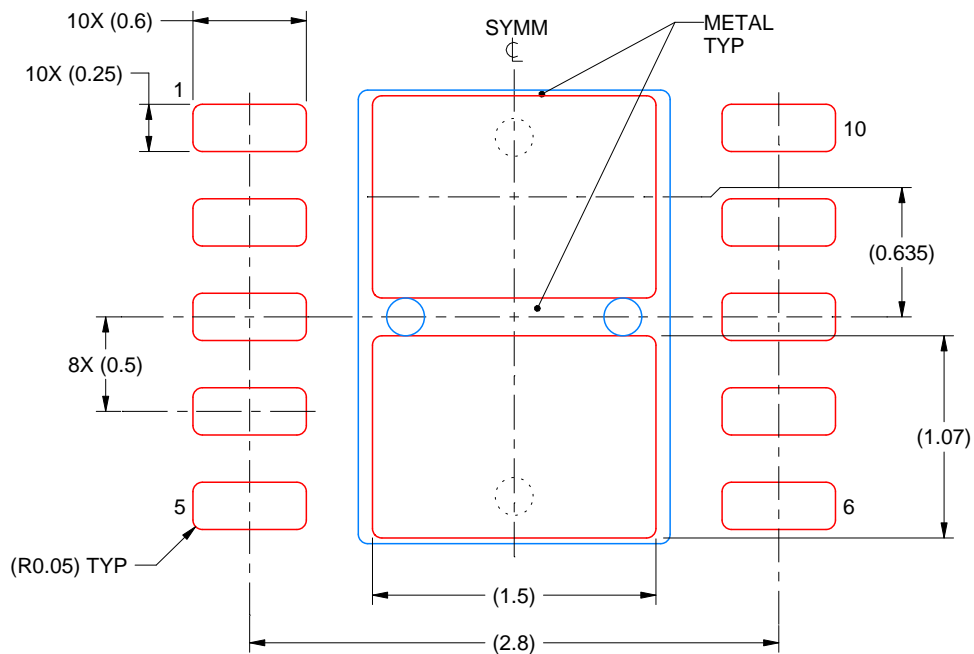

SOLDER PASTE EXAMPLE  
BASED ON 0.125 mm THICK STENCIL

EXPOSED PAD  
81% PRINTED SOLDER COVERAGE BY AREA  
SCALE:25X

4222059/B 02/2018

NOTES: (continued)

5. Laser cutting apertures with trapezoidal walls and rounded corners may offer better paste release. IPC-7525 may have alternate design recommendations.

## IMPORTANT NOTICE AND DISCLAIMER

TI PROVIDES TECHNICAL AND RELIABILITY DATA (INCLUDING DATASHEETS), DESIGN RESOURCES (INCLUDING REFERENCE DESIGNS), APPLICATION OR OTHER DESIGN ADVICE, WEB TOOLS, SAFETY INFORMATION, AND OTHER RESOURCES "AS IS" AND WITH ALL FAULTS, AND DISCLAIMS ALL WARRANTIES, EXPRESS AND IMPLIED, INCLUDING WITHOUT LIMITATION ANY IMPLIED WARRANTIES OF MERCHANTABILITY, FITNESS FOR A PARTICULAR PURPOSE OR NON-INFRINGEMENT OF THIRD PARTY INTELLECTUAL PROPERTY RIGHTS.

These resources are intended for skilled developers designing with TI products. You are solely responsible for (1) selecting the appropriate TI products for your application, (2) designing, validating and testing your application, and (3) ensuring your application meets applicable standards, and any other safety, security, or other requirements. These resources are subject to change without notice. TI grants you permission to use these resources only for development of an application that uses the TI products described in the resource. Other reproduction and display of these resources is prohibited. No license is granted to any other TI intellectual property right or to any third party intellectual property right. TI disclaims responsibility for, and you will fully indemnify TI and its representatives against, any claims, damages, costs, losses, and liabilities arising out of your use of these resources.

TI's products are provided subject to TI's Terms of Sale ([www.ti.com/legal/termsofsale.html](http://www.ti.com/legal/termsofsale.html)) or other applicable terms available either on [ti.com](http://ti.com) or provided in conjunction with such TI products. TI's provision of these resources does not expand or otherwise alter TI's applicable warranties or warranty disclaimers for TI products.

Mailing Address: Texas Instruments, Post Office Box 655303, Dallas, Texas 75265  
Copyright © 2020, Texas Instruments Incorporated