

Overview

The KEMET SS Coils, SS11VL Type AC line filters are offered in a wide variety of sizes and specifications.

Applications

- Consumer Electronics
- Common mode choke

Benefits

- Wide variety of sizes and specifications
- Super low profile: 20.5 mm maximum
- Inductances up to 82 mH
- Rated Currents up to 3 A
- DC Resistances as low as 0.06 Ω

**Part Number System**

SS	11	VL-	R	03	550
Series	Core Size (mm)	Core Orientation	Core Type	Rated Current AC (A)	Inductance (H) Minimum
SS	11 = 11.0 mm	VL- = Vertical	Blank = Standard R = High permeability	0x = 0.x A xx = x.x A Examples: 03 = 0.3 A 13 = 1.3 A	xx0 = xx mH 0xx = x.x mH Examples: 550 = 55 mH 024 = 2.4 mH

Dimensions – Millimeters

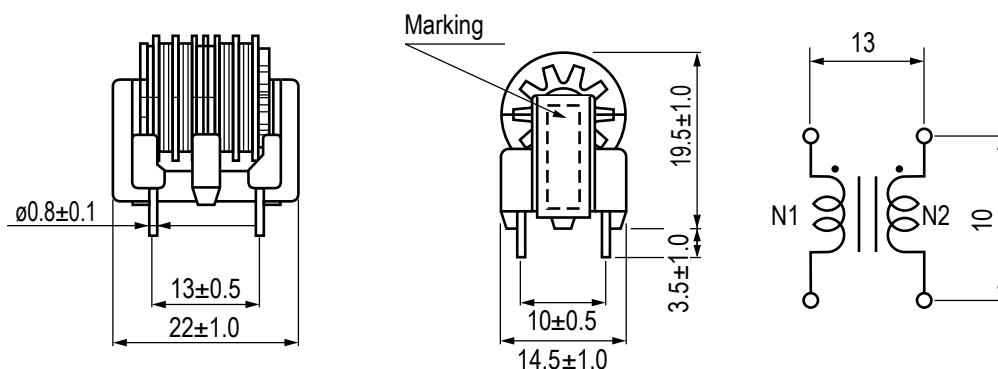

Environmental Compliance

All KEMET AC Line Filters are RoHS Compliant.



Table 1 – Ratings & Part Number Reference

Part Number	Rated Current AC (A)	Inductance (mH) Minimum	DC Resistance/ Line (Ω) Maximum	Temperature Rise (K) Maximum	Marking	Weight (g) Approximate
SS11VL-03550	0.3	55.0	4.10	45	03 Lot No.	10.5
SS11VL-04350	0.4	35.0	2.60	45	04 Lot No.	10.7
SS11VL-05230	0.5	23.0	1.80	45	05 Lot No.	10.5
SS11VL-06180	0.6	18.0	1.30	45	06 Lot No.	11.1
SS11VL-07120	0.7	12.0	0.90	45	07 Lot No.	10.8
SS11VL-08083	0.8	8.3	0.74	45	08 Lot No.	9.8
SS11VL-10062	1.0	6.2	0.44	45	10 Lot No.	11.1
SS11VL-11050	1.1	5.0	0.40	45	11 Lot No.	10.7
SS11VL-13035	1.3	3.5	0.28	45	13 Lot No.	10.5
SS11VL-17024	1.7	2.4	0.19	45	17 Lot No.	10.8
SS11VL-22013	2.2	1.3	0.12	45	22 Lot No.	10.4
SS11VL-30006	3.0	0.6	0.06	45	30 Lot No.	9.6
SS11VL-R03820	0.3	82.0	4.10	45	R03 Lot No.	10.5
SS11VL-R04520	0.4	52.0	2.60	45	R04 Lot No.	10.7
SS11VL-R05350	0.5	35.0	1.80	45	R05 Lot No.	10.5
SS11VL-R06270	0.6	27.0	1.30	45	R06 Lot No.	11.1
SS11VL-R07190	0.7	19.0	0.90	45	R07 Lot No.	10.8
SS11VL-R08125	0.8	12.5	0.74	45	R08 Lot No.	9.8
SS11VL-R10093	1.0	9.3	0.44	45	R10 Lot No.	11.1
SS11VL-R11076	1.1	7.6	0.40	45	R11 Lot No.	10.7
SS11VL-R13052	1.3	5.2	0.28	45	R13 Lot No.	10.5
SS11VL-R17036	1.7	3.6	0.19	45	R17 Lot No.	10.8
SS11VL-R22020	2.2	2.0	0.12	45	R22 Lot No.	10.4
SS11VL-R30009	3.0	0.9	0.06	45	R30 Lot No.	9.6

Specifications

Item	SS11VL
Rated Voltage	250 VAC
Withstanding Voltage	2,400 VAC (2 seconds, between lines)
Insulation Resistance	> 100 MΩ at 500 VDC (between lines)
Thermal Class	E (120°C)
Operating Temperature Range	-25°C to T (T = 120 – temperature rise)
Inductance Measurement Condition	1 kHz, 1 V, KC530

Frequency Characteristics

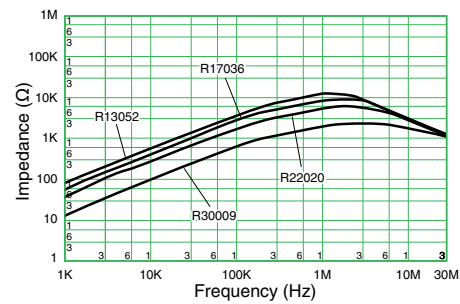
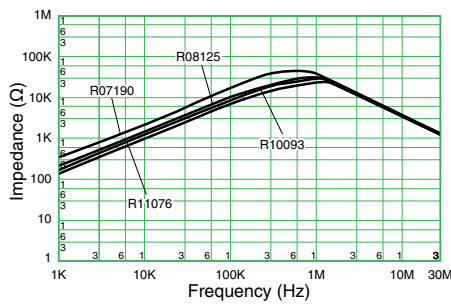
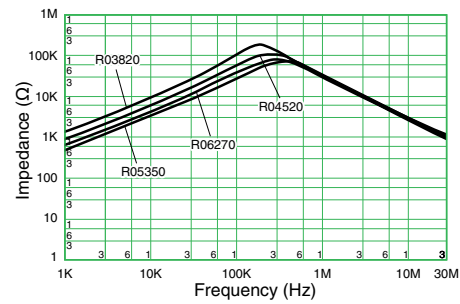
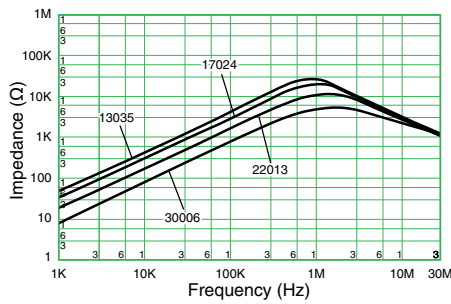
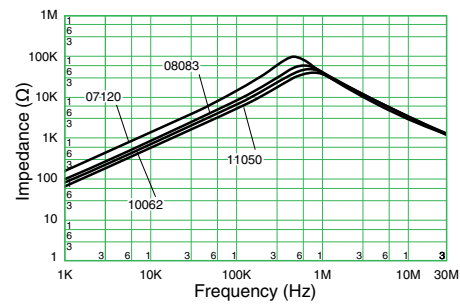
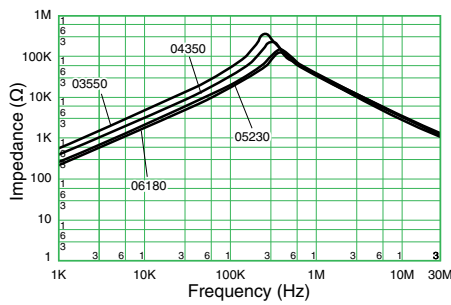

Notes on Use

Shelf Life

- Use within 6 months. If the product is used after a storage period of 6 months or longer, confirm its solderability before use.

Storage Condition

- Avoid storage in high temperature and high humidity environment, as such condition may deteriorate the solderability of external electrode.
- Avoid storage in atmosphere containing toxic gases or acid (e.g., sulphur and chlorine), as such gas may deteriorate the solderability of external electrode.
- Avoid storage near strong magnetic field, as such condition may magnetize the product.

KEMET Electronics Corporation Sales Offices

For a complete list of our global sales offices, please visit www.kemet.com/sales.

Disclaimer

All product specifications, statements, information and data (collectively, the "Information") in this datasheet are subject to change. The customer is responsible for checking and verifying the extent to which the Information contained in this publication is applicable to an order at the time the order is placed. All Information given herein is believed to be accurate and reliable, but it is presented without guarantee, warranty, or responsibility of any kind, expressed or implied.

Statements of suitability for certain applications are based on KEMET Electronics Corporation's ("KEMET") knowledge of typical operating conditions for such applications, but are not intended to constitute – and KEMET specifically disclaims – any warranty concerning suitability for a specific customer application or use. The Information is intended for use only by customers who have the requisite experience and capability to determine the correct products for their application. Any technical advice inferred from this Information or otherwise provided by KEMET with reference to the use of KEMET's products is given gratis, and KEMET assumes no obligation or liability for the advice given or results obtained.

Although KEMET designs and manufactures its products to the most stringent quality and safety standards, given the current state of the art, isolated component failures may still occur. Accordingly, customer applications which require a high degree of reliability or safety should employ suitable designs or other safeguards (such as installation of protective circuitry or redundancies) in order to ensure that the failure of an electrical component does not result in a risk of personal injury or property damage.

Although all product-related warnings, cautions and notes must be observed, the customer should not assume that all safety measures are indicated or that other measures may not be required.

KEMET is a registered trademark of KEMET Electronics Corporation.

Mouser Electronics

Authorized Distributor

Click to View Pricing, Inventory, Delivery & Lifecycle Information:

KEMET:

[SS11VL-R22020](#) [SS11VL-R17036](#) [SS11VL-R13052](#) [SS11VL-07120](#) [SS11VL-17024](#) [SS11VL-R11076](#) [SS11VL-10062](#) [SS11VL-R30009](#) [SS11VL-13035](#) [SS11VL-R10093](#) [SS11VL-R08125](#) [SS11VL-R07190](#) [SS11VL-08083](#) [SS11VL-05230](#) [SS11VL-06180](#) [SS11VL-R06270](#) [SS11VL-R03820](#) [SS11VL-04350](#) [SS11VL-R05350](#) [SS11VL-R04520](#) [SS11VL-03550](#) [SS11VL-30006](#) [SS11VL-22013](#) [SS11VL-11050](#)