

PLEASE CHECK WWW.MOLEX.COM FOR LATEST PART INFORMATION

Part Number: [0532530870](#)
Status: **Active**
Description: 2.00mm Pitch Micro-Latch Wire-to-Board Header, Vertical, Square Pin, Three-sided Shroud, 8 Circuits

Documents:

3D Model	Packaging Specification SPK-53253-001-001 (PDF)
Drawing (PDF)	RoHS Certificate of Compliance (PDF)
Product Specification PS-51065-016-001 (PDF)	Product Literature (PDF)

General

Product Family	PCB Headers
Series	53253
Application	Signal, Wire-to-Board
Product Literature Order No	987651-8983
Product Name	Micro-Latch
UPC	756054354063

Physical

Breakaway	No
Circuits (Loaded)	8
Circuits (maximum)	8
Durability (mating cycles max)	30
First Mate / Last Break	No
Glow-Wire Capable	No
Lock to Mating Part	Yes
Material - Metal	Brass
Material - Plating Mating	Tin
Material - Plating Termination	Tin
Material - Resin	Nylon
Net Weight	269.100/mg
Number of Rows	1
Orientation	Vertical
PC Tail Length	3.50mm
PCB Locator	No
PCB Retention	Yes
PCB Thickness - Recommended	1.60mm
Packaging Type	Tray
Pitch - Mating Interface	2.00mm
Plating min - Mating	1.016µm
Plating min - Termination	1.016µm
Polarized to Mating Part	Yes
Polarized to PCB	No
Shrouded	Partial
Stackable	No
Surface Mount Compatible (SMC)	No
Temperature Range - Operating	-40° to +105°C
Termination Interface: Style	Through Hole

Electrical

Current - Maximum per Contact	2.0A
Voltage - Maximum	125V

Material Info

Reference - Drawing Numbers

Packaging Specification	SPK-53253-001-001
Product Specification	PS-51065-016-001

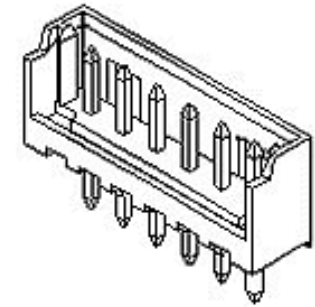

Series image - Reference only

EU ELV

Not Relevant

EU RoHS

Compliant

REACH SVHC

Not Contained Per -
ED/61/2018 (27 June
2018)

Halogen-Free

Status

Not Low-Halogen

Need more information on product environmental compliance?

Email productcompliance@molex.com
Please visit the [Contact Us](#) section for any non-product compliance questions.

China ROHS	Green Image
ELV	Not Relevant
Prop65	Compliant
RoHS Phthalates	Not Contained

Search Parts in this Series

[53253](#) Series

Mates With

[51065](#) Crimp Housing, [50212](#) Crimp Terminal

This document was generated on 09/10/2018

PLEASE CHECK WWW.MOLEX.COM FOR LATEST PART INFORMATION

Mouser Electronics

Authorized Distributor

Click to View Pricing, Inventory, Delivery & Lifecycle Information:

[Molex:](#)

[53253-0870](#)