



Dynamic Series Connectors

RoHS
Ready 



EVERY CONNECTION COUNTS

Dynamic Series List

Series	Family images	Name of Series		Electrical Performance				Pitch (mm)	Wire Range (AWG)			
		Spec. Name	Description	Maximum Current Rating (A)	Maximum Voltage Rating (V AC/DC)	Withstanding Voltage (V AC/1 minute)	Durability (Cycles)					
1000 (P10 - 24)		1100S	Standard	3	125	700	50 (Gold 0.38u) 30 (Tin)	2.0	30 - 22			
		1100D	Standard									
		1200S	High Voltage	5	250	1100		2.5	30 - 18			
		1200D	High Voltage									
		1500T	Module Type									
1900	Spring Clamp Type	4	150	1100	3.5	24 - 20						
2000 (P.25 - 33, P.89, P.92)		2100S	Standard Type	5	250	1500	500 (Gold 0.38u)	2.5	28 - 18			
		2100D	Standard Type									
		2100M	Multiposition Drawer	2.6				24	D-2 (3.2) D-3 (7.5)	D-2 (28 - 18) D-3 (28 - 14)		
		2600D	Hybrid Power/Signal									
		2800	HTS Modular/Multi-frame	5							3.0	28 - 18
3000 (P.34 - 61, P.90, P.92)		3100S	Standard Type	15	250	1500	500 (Gold 0.38u, 0.76u) 1000 (Tin)	3.81	28 - 14			
		3100D	Standard Type					3.81				
		3100M	Modular Type		3.81							
		3200S	High Voltage Type		600	2200		5.08				
		3200M	High Voltage Type					5.08				
		3200T	High Voltage Type		5.08							
		3400F	Skyscraper		250	1500		3.81				
		3500D	Modular Type		600	2200		5.08				
		3700	For Motors		250	1500		3.81				
		3800	HTS Module		600	2200		5.2				
		3900	Spring Clamp		14.5	300		1500		500	7.5	22 - 14
		*3950	Spring Clamp		14.5	300		1500		500	7.5	22 - 14
		4000 (P.62 - 68, P.90, P.92)			4200S	Standard Type		24		600	2500	25 (Gold 0.38u)
4200M	Modular Type			24	600	2500	6.35					
4800	HTS Modular/Multi-frame			24	600	2500	6.35					
5000 (P.69 - 84, P.90, P.92)		5200S	Standard	30	630	3000	50 (Gold 0.76u) 25 (Gold 0.38u) 25 (Silver) 50 (Gold 0.76u) 25 (Gold 0.38u)	10.16	16 - 8			
		5200S	Cable Clamp									
		5200D	Cable Clamp									
		5200M	High Voltage	45				25 (Silver)	20 - 8			
		5200Ma	High Current									
		5300S	Reversed Housing	30				50 (Gold 0.76u) 25 (Gold 0.38u)	16 - 8			
		5300D	Reversed Housing									
		5800	HTS Module	42				600	3000	25 (Gold)	13.10	16 - 8
		5900	Spring Clamp									
DZ-5200	Board to Board	20	250		2200	5.08	-					
DZ-5200	Board to Board	30	600	4000	15 (Gold)	10.16						
7000 (P.94 - 99)		7100	Standard Type	65	630	3000	20 (Silver)	16.0	16 - 6			
		7300	Reverse Type									
Special Products		Dynamic Pneumatic Connector		Refer the Product Specification 108-78406				8.5	Ø4.6 (Tube)			
		Multiple Enclosure Connector		Refer the catalog								

Dynamic Series List

Number of Position (Pos)	Number of Row (row)	Housing Types										Safety Standards UL CSA TUV	Product Specification	Application Specification		
		Wire to Wire		Wire to Board				DIN Rail	Tap	Junction Box	Drawer				Board to Board	
		Free Hanging	Panel Mount	DIP		SMT										
4,8,10	1	-	-	-	o	-	o	-	-	-	-	-	-	o	108-78268 (Gold Plating) 108-78298 (Tin Plating)	114-5377
10,18,20,22,24,26,28,30,32,34,50,44	2	o	o	o	o	o	o	-	-	-	-	-	-	o		
2	1	o	-	o	-	-	-	-	-	-	-	-	-	o		
4,6,8,10,12,16,20	2	o	o	o	o	o	-	-	-	-	-	-	-	o		
3,6,9,12,34,36	3	o	o	o	o	-	-	o	-	o	-	-	-	o		
8,12,16,22,30,38	2	-	o	o	-	-	-	-	-	-	-	-	-	o		
3	1	o	o	g	o	-	-	-	-	-	-	-	-	o	108-5619 (S/D) 108-5659 (M)	114-5897
6,8,12,16,20	2	o	o	o	o	-	-	-	-	-	-	-	-	o		
50	2	o	o	-	o	-	-	-	-	-	o	-	x			
D-2 (36) D-3 (12)	D-2 (2) D-3 (1)	-	-	o	-	-	-	-	-	-	-	-	-	x	108-78301	
30	6	o	o	-	-	-	-	-	-	-	-	-	-	x	108-78284	114-5258
3,4,5,6,8,10,6x3(Tap)	1,3(Tap)	o	o	o	o	o	o	-	o	-	-	-	-	o	108-5349	114-5148
6,8,10,12,16,20	2	o	o	o	o	-	-	-	-	-	-	-	o	o		
6	1x2			o	o	-	-	-	-	-	-	-	-	o		
2,3,4,5,6,4x6(Tap)	1,6(Tap)	o	o	o	o	o	o	-	o	-	-	-	-	o		
6,10,12,20	2	o	o	o	o	-	-	-	-	-	-	-	o	o		
9	3	-	-	-	o	-	-	-	-	-	-	-	-	o		
12,20	4	-	-	-	o	-	-	-	-	-	-	-	-	o		
2,4,6,10,12,20	2	o	o	o	o	-	-	-	-	-	-	-	-	o		
6	1	-	o	-	-	-	-	-	-	-	-	-	-	o		
12	4	o	o	-	-	-	-	-	-	-	-	-	-	o		
3,7,10	1	-	-	-	o	-	-	-	-	-	-	-	-	o		
3,6,11	1	-	-	-	o	-	-	-	-	-	-	-	-	o		
2,3,4	1	o	o	o	o	-	-	-	-	-	-	-	-	o	108-78182	114-5369
6	1x2	o	o	-	-	-	-	-	-	-	-	-	-	o		
8	2	o	o	-	-	-	-	-	-	-	-	-	-	o		
2,3,4,6	1	o	o	o	o	-	-	-	-	-	-	-	-	o	108-5453	114-5206
3		-	-	-	o	-	-	-	-	-	-	-	-	o		
4	2	o	-	-	-	-	-	-	-	-	-	-	-	o		
4,6,8,4x5(Tap)	1,2	o	o	-	o	-	-	o	o	-	-	-	-	o		
2,4	2	-	-	-	o	-	-	-	-	-	-	-	-	o		
3	1	-	o	-	-	-	-	-	-	-	-	-	-	o		
4	2	-	o	-	-	-	-	-	-	-	-	-	-	o		
4	2	o	o	-	-	-	-	-	-	-	-	-	-	o	108-5453	-
4,6	1	-	-	-	o	-	-	-	-	-	-	-	-	o	108-140022	
5,7	1	-	-	-	-	-	-	-	-	-	-	-	-	x	108-78470	114-5452
3,4		-	-	-	-	-	-	-	-	-	-	-	-	x		
4	2	o	o	-	o	-	-	-	-	-	-	-	-	x	108-78470	114-5452
		o	o	-	-	-	-	-	-	-	-	-	-	x		
2,8	1,2	o	o	-	-	-	-	-	-	-	-	-	-	-	108-78406	-
15,24,32	4,8	-	o	-	-	-	-	-	-	-	-	-	-	-	108-78417	114-5377

Contact Features (Example of the D-3000 Series)

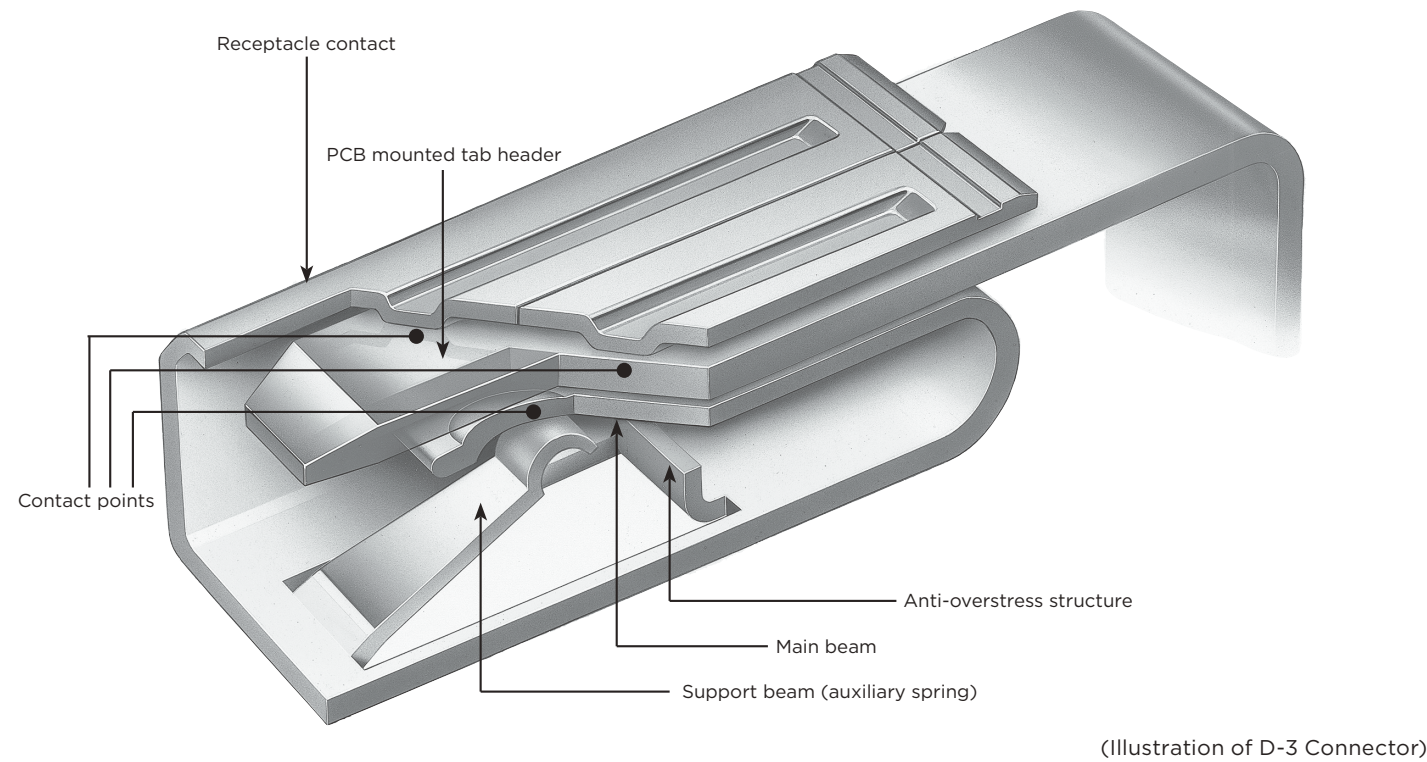

Contact Pressure Adjustment Method

- Gold-plated and tin-plated contacts are available. Adjustable gaps for the auxiliary spring (at positions of A-C) to get the optimum contact pressure. For gold-plated product, both high Contact Pressure and standard contact pressure are available in accordance with the intended use
- Anti-overstress structure prevents damage to the main beam which might be caused by insertion of foreign objects or twisting (Receptacle contact type of D-2 S, M/D-3 S, M, L, 2L, 3L/D-5 S, M)

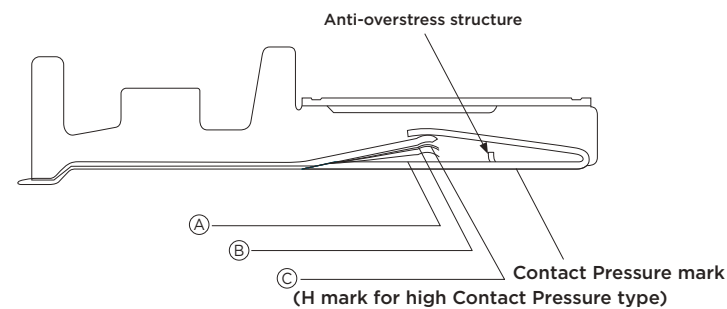

Plating	Type	Contact Pressure	Position	Contact Pressure mark	Applicable unit	Specifications	Application	Mating Cycles
Gold-plated	Standard Contact Pressure	Around 1.47N	A	—	1-100	Standard	Used for signal/current Multipolar direction and High mating cycles circuits	500
	High Contact Pressure	Around 2.45N	B	H	1-20	Vibration/High current	Used for signal/Power supply/Motor, Applications for high-vibration ion	500
Tin-plated	High Contact Pressure	Around 3.92N	C	H	1-10	High Current	Used for Signal/Power supply Circuits low mating cycles	100

Contact Features (Example of D-3000 Series)

Tab/Receptacle Contact

Male side is tab, while female side is receptacle contact so as to avoid twisting. (Refer to Figure on the left) Highly reliable 3-point contacts are used.

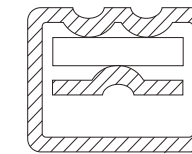

Housing Lance

The housing lance is used to secure the contact in place. The lance ensures the contact stays secure in the housing and helps prevent damage during contact mating. In addition to these protective features the housing lance produces an audible "click" ensuring the contact is securely locked in the housing. The contact can still be easily removed securely with specialized tooling.

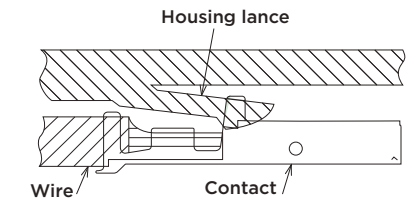

Confirmation Marks

- Contact Pressure marks....."H" mark on the bottom of the contact for high contact-pressure product (Standard Contact pressure for those without the marks) (Only for D-3 connector)
- Plating marks.....To show clearly types and thickness of the plating, following numbers will be marked on the side of the contact. This number is consistent with the additional number of contact's part model number.
 - 2.....Gold plating 0.38Qm Thickness
 - 3.....Gold plating 0.76Qm Thickness
 - 5.....Tin plating
- Shared marks on the contact and the tool to avoid misuse of hand tools and extraction tools, wire range marks (SS, S, M, L) will be used from different the contact size marks (D-1/D-2/D-3/D-4/D-5)

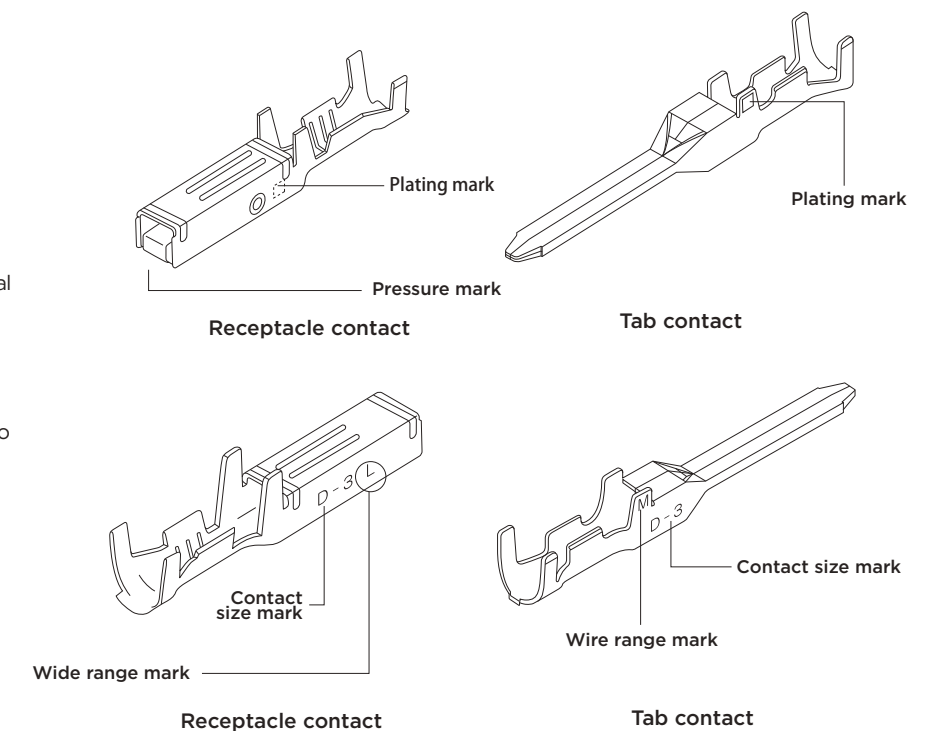

Wire range marks

D-1	S	AWG#30-28	D-4	M	AWG#16-14
	M	AWG#28-22		L	AWG#14-12
	L	AWG#28-22	D-5/D5α	SS	AWG#20-16
	2L	WG#22-18		S	AWG#16-14
D-2	S	AWG#28-24		M	AWG#12-10
	M	AWG#22-18		L	AWG#8
D-3	S	AWG#28-24			
	M	AWG#24-20			
	L	AWG#20-16			
	2L	AWG#16-14			
	2L	AWG#16-14			

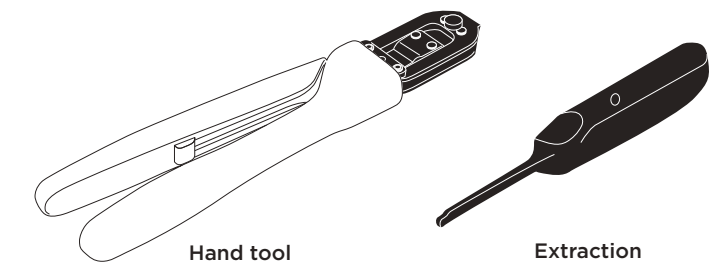

Housing Features (Example of D-3000 Series)

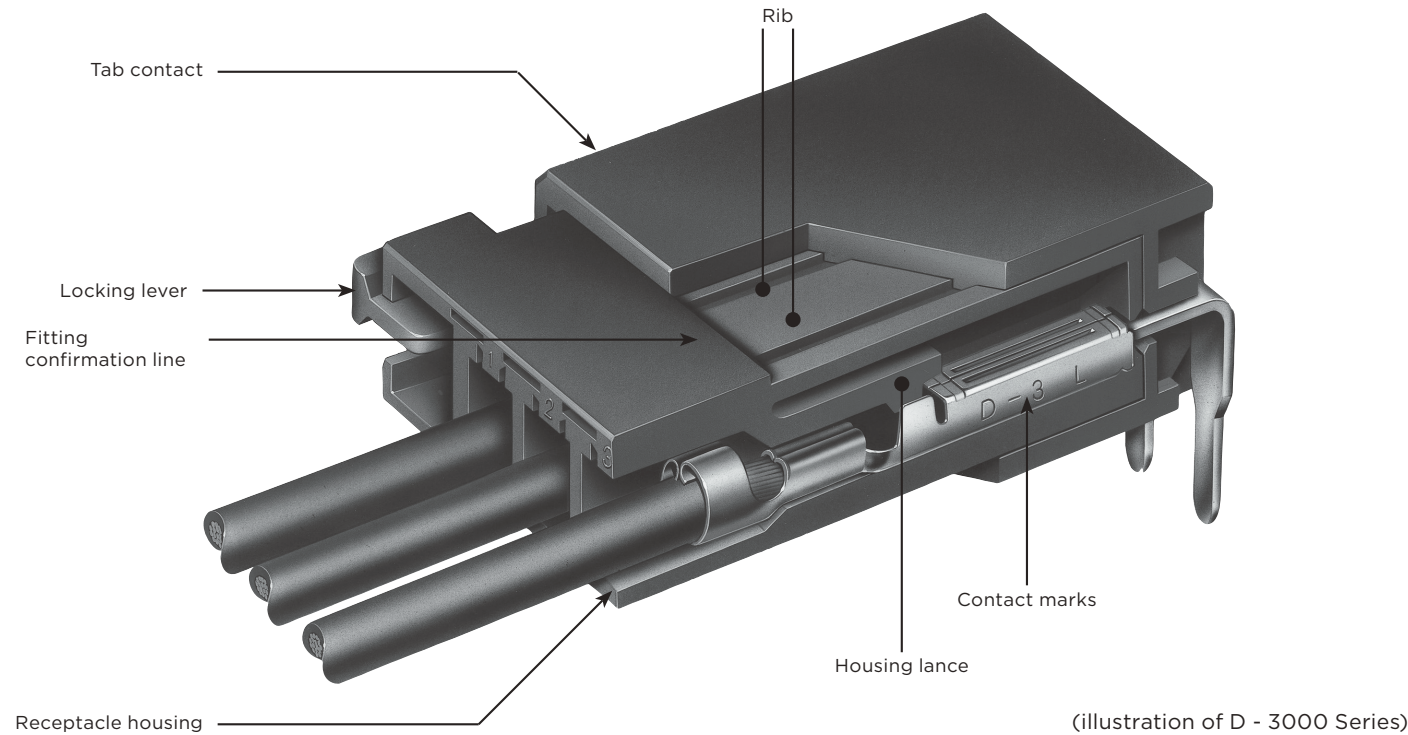

(illustration of D - 3000 Series)

Easy to insert and extract the connector

- When you insert or extract the connector, a clear "lock" sound will be heard. A fitting confirmation line is provided to confirm the operation both with your ears and eyes
- Pinch 2 locks on both sides of the housing to easily extract the connector (D -3100/D-3200/D-4000/D-5200 Series)
- For safety consideration, well rounded corners will be used

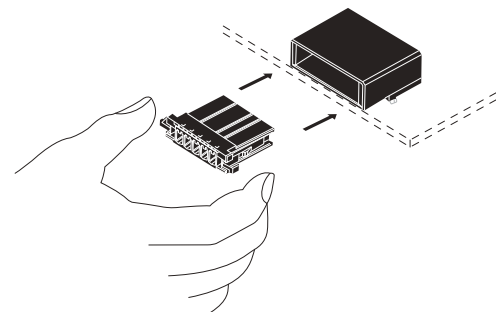

to prevent hand injuries when inserting or extracting the connector

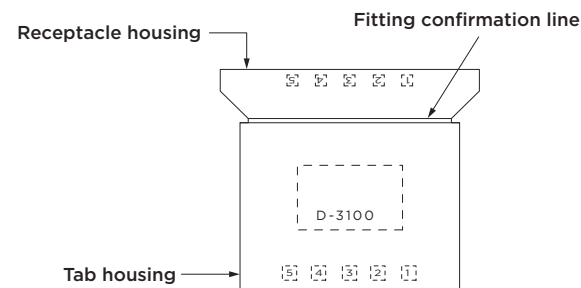

Vertical-type header

To avoid mis-installation or mis-alignment of the boards, keep in mind the direction (Concave) of Vertical-type header (only available for D-3000 Series)

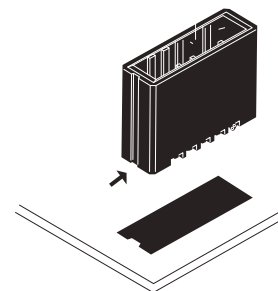

Housing to protect tine part

For protecting the solder tine, horizontal-type header will be fully applied to cover type.

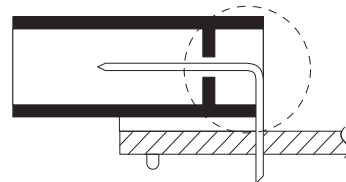

Features of the housing (Example of D-3000 Series)

Retention legs for board mounting

For robotic automatic implementation, the retention legs will be provided for both the vertical-type and the horizontal-type header. Especially for the horizontal-type header, it is possible to mount to the bottom of the housing and it will not take up as wide a space as the conventional system.

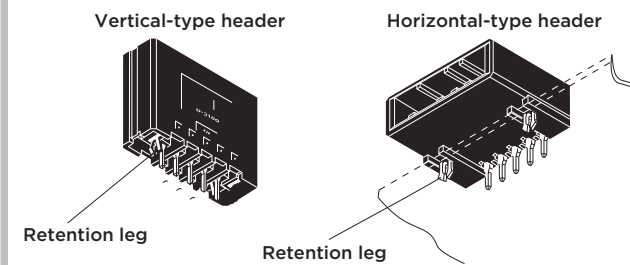

Note: Retention legs are used for board with 1.6mm thickness. If used for board with 2.4mm thickness, strength will be reduced.

Retention legs are close to the insertion part of the receptacle housing so as to resist tilting caused by the cable (Patent number 2,508,076).

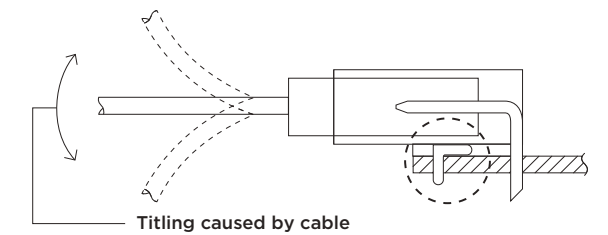

Twisting Prevention Structure

The ribs are used in both the receptacle housing and tab housing. This safety design can be used to avoid any backlashes between housings after the receptacle housing has been completely inserted into tab housing.

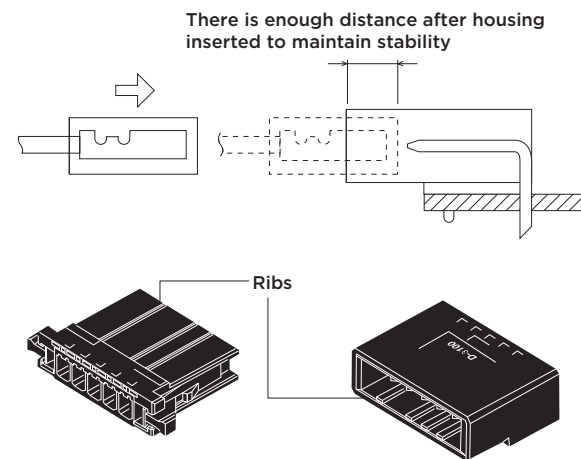

Misinsertion Preventing Mechanism

Part of the products (D-1200D/D-2100/D-2100D/D-3100/D-3100M/D-3200/D-3200M/D-3200T/D-4000/D-5200/D-5200M) is provided with keying to prevent incorrect insertion. By using this plug, it also makes it easier to prevent incorrect insertion of other items. (Refer to P.104, only available for D-3000 Series)

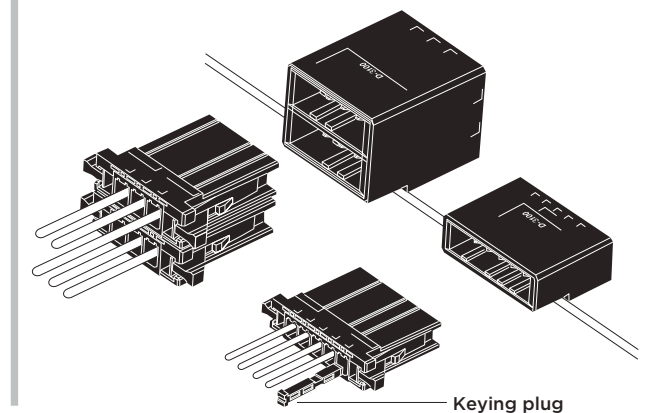

Label Mark

A flat side portion is provided in the housing for custom labels.

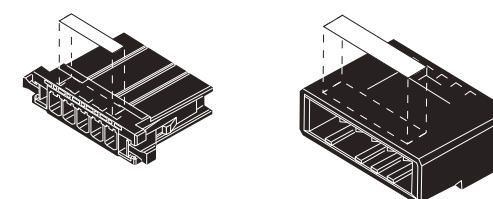

Easy-to-read circuit number

To facilitate cable assembly, tab and receptacle housings will be marked with circuit numbers.

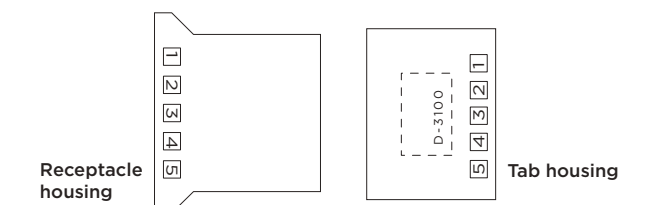

Dynamic Series Connectors

Guideline for selecting plating (These guidelines apply to the D-3000 series only. Please note that they may not be suitable for other products.)

Whether to use gold or tin plating varies depending on the voltage, current, environment (vibration, temperature, gas, etc.), number of contact positions, and other variables. Gold plating is recommended for general

industrial machinery, but in reality cost considerations are also a factor. To help in this selection, these guidelines have been put together for the Dynamic Series as a reference in the selection process.

1) Selection based on voltage and current

	Gold-plated	Undetermined zone	Tin-plated	No plating (reference)
Voltage	Below 3 V	3 to 30 V	30 to 100 V	Over 100 V
Current	Below 1 A	1 to 10 A	Over 10 A	Over 0.1 A

(Table - 1)

Table 1 shows us that gold should always be used for applications under 3 volts and 1 ampere. When the voltage is over 30 and amperage is over 1, tin plating can be used. The most difficult area to make a selection is in the undetermined zone. In this zone either gold or tin plating can be used, but

the environment causes extensive variation. In a clean environment tin plating is acceptable. However, use gold plating if the environment is bad, such as in high heat or humidity, the presence of gas is possible, vibration is extreme, mating and demating are excessive, or other factors.

2) Selection based on number of contact positions (selection based on contact pressure)

Selecting based on the number of contact positions is often forgotten. The higher the contact pressure the more possible it is to use tin plating or no plating, regardless of the voltage or current mentioned in section 1. However, if they are too high, mating and demating become impossible so the connector function is lost. To get around this, we can drive the voltage and current down into a workable zone, but then we run into the problem of oxidation. Then, to prevent oxidation, we use tin (approximately 2.94 N optimum contact pressure) or gold (approximately 1.18 N) plating. But, the contact pressure increases proportionally as we increase the number of contact positions, causing mating and demating to become difficult. Generally speaking, given a 39.2 N limit for mating/demating by hand, it becomes difficult without

using leverage, such as a lever or jack screw. The Dynamic D-3000 series has a maximum of 20 contact positions. That means the contact pressure with tin plating is 3.92 N, and with gold plating is 2.45 N and 1.47 N (high pressure types and standard types are available for some applications). For instance, given 3.92 N for tin plating, we can calculate insertion and extraction forces of 58.8 N and 49.0 N, which is difficult because it exceeds the range for barehanded work. Once we understand this, we see that as contact positions increase we must use gold plating regardless of the voltage and current conditions mentioned in section 1. Table 2 shows the applicable maximum number of contact positions as a reference.

Contact pressure	Applicable maximum number of contact positions
(1) Gold plating Standard contact pressure: 1.47N	20
(2) Gold plating High contact pressure: 2.45N	20
(3) Tin plating High contact pressure: 3.92N	12

(Table - 2) Note: Insertion force and extraction force are not the same as contact pressure.

3) Environment (vibration, humidity, gas, etc.)

Although the environment was discussed in section 1 about voltage and current, it is summarized again here. Use gold plating in a bad environment, particularly for high vibration or heat, the presence of gas or other bad conditions. Gold is a noble metal. This means that gold does not react easily with other materials, which means that its surface does not oxidize or tarnish when exposed to air. Of all metals, only gold has this property. Other metals, noble metals except

gold, such as platinum or rhodium for example, do not produce absolutely no oxide film. This is a very important property for contacts. In consideration of this, there is no better material than gold plating if the environment is bad. Also, if vibration is an issue, there is the risk of fretting corrosion (micro-abrasion). Always use gold plating. If possible, high-contact pressure connectors are recommended.

Dynamic Series Connectors

Guideline for selecting plating (These guidelines apply to the D-3000 series only. Please note that they may not be suitable for other products.)

4) Other considerations

■Contact between dissimilar metals

Combining tin and gold tends to create a lot of ionization, producing electrolytes from condensation so corrosion is likely to occur. This combination is not recommended because it could produce worse results than a combination of just tin.

■Being consistent within an application

We recommend that, as much as possible, the same type of plating be used within an application. This is to prevent connections being made between dissimilar metals, gold and tin as mentioned above, during assembly and maintenance. And for the same reason, we recommend using the same plating in factories or workplaces where assembly or harness production is done.

The above information has been summarized in "Plating selection at a glance" for your convenience.

- ★★★★ Best
- ★★★ Good
- ★★ Usable
- Not usable

Plating selection at a glance

Voltage/current	Application	Tin-plated	Gold-plated			
			0.38μ		0.76μ	
			Standard pressure	High pressure	Standard pressure	High pressure
Below 3 V Below 1 A	Standard specifications	—	★★	★★	★★★★	★★★★
	Vibration	—	★	★★	★	★★★★
	Bad environment	—	★	★	★★	★★★★
	Extensive mating/unmating	—	★★	★	★★★★	★★
3 to 30 V 1 to 10 A	Standard specifications	—	★★	★★	★★★★	★★★★
	Vibration	—	★	★★	★	★★★★
	Bad environment	—	★★	★★	★★★★	★★★★
	Extensive mating/unmating	—	★★	★	★★★★	★★
Over 30 V Over 1 A	Standard specifications	★★	★★★★	★★★★	★★★★	★★★★
	Vibration	—	★★	★★★★	★★	★★★★
	Bad environment	—	★★	★★	★★★★	★★★★
	Extensive mating/unmating	—	★★★★	★★	★★★★	★★
Over 30 V Over 1 A	Standard specifications	—	★★★★	★★	★★★★	★★
	Vibration	—	★★★★	★★	★★★★	★★
	Bad environment	—	★★★★	★★	★★★★	★★
	Extensive mating/unmating	—	★★★★	★★	★★★★	★★

The above table is basically for industrial machinery, and was made with a wide margin. This table is not applicable for every situation as there are many combinations depending on the application. It is intended to be used as a guideline only.

D-1000 Series

Series Introduction

D-1000 Series are the smallest connectors for signal lines among all the Dynamic connector series. The Dynamic 1000 Series consists of 3 different pitch sizes: 2.0mm standard type, 2.5mm high-voltage type and 3.5mm type.

D-1000 Series has gold plated contacts to maintain its high reliability and also tin plated contacts for economical market needs. Customers can choose their own contacts according to specifications, applications and cost.



Product features

- Wide Applicable Wire Range**
D-1000 series has wide applicable wire range of 30 AWG through 18 AWG with 2.2 mm of outside diameter maximum (D-1200/ D-1500). Therefore there are no special safety considerations using it in electrical cabinets.
- Hand Tools are available for all wire sizes.**
It can save on delivery lead time and involve minimal installation tooling costs.
- Housing and Contact Features**
A) Housing products
The D-1000 series consists of D-1100 series for 2.0mm pitch center line, D-1200 series for 2.5mm pitch center line as standard type. In addition, the D-1500 series and D-1900 series have a pitch of 3.5mm

B) Contact Products

- D-1000 series provide gold plating contact as standard products and also tin plating contact for economical market needs. You can choose the contact according to your own specifications, application, and quality level and cost, so that you can utilize D-1000 series in many places
- Other Features (Basic Dynamic series features)**
 - Header connector and tab connector have enough length from the tip of contact to top of its housing. To prevent contact from bending during mating
 - D-1000 series are provided with housing lance structure
 - Clear identification of circuit number helps with correct wiring
 - Metal retention leg on header prevents unwanted movement from cable tension
 - Housing lock design offers no wire scratching

Note: All Part Numbers are RoHS compliant.
You need to confirm LOT size and lead time.

D-1000 Series Main Performance and Specifications

Main Performance

Item	Series	D-1100	D-1200	D-1500	D-1900
Pitch		2.0mm	2.5mm	3.5mm	3.5mm
Voltage rating		125V AC/DC	250V AC/DC	250V AC/DC	150V AC/DC
Current rating (Max)		1 pos: 3A in use of AWG22	1 pos: 5A (In use of AWG18)	1 pos: 5A (In use of AWG18)	1 pos: 4A In use of AWG18
Contact Resistance		20mΩ Max.			40mΩ Max
Dielectric Withstanding		1,000V AC	1,500V AC	1,500V AC	1,100V AC
Temperature		-55 - 105			-30 - 105

No. of Pos/Wire size/Current

D-1100-1500

No. of Pos.	Wire Size (AWG)						
	18	20	22	24	26	28	30
1	5	4	3	2.5	2	1.5	1
2-20	3.5	2.7	2.5	2	1.5	1	0.8
21-40			2	1.5	1	0.8	0.5

D-1900 Series

No. of Pos.	Wire Size AWG			
	18	20	22	24
8-12	3	2	1.5	1
13-38	2	1.5	1	0.5

Specifications • Instructions sheet

Product Specifications	108-78268 (goldplated)
	108-78298 (tin-plated)
	108-78336 D-1900
Applications Specifications	114-5377 D-1100 D-1200 D-1500
	114-539 D-1900
Crimping tool instruction sheet	Part number: 1762952-1 411-78205
	Part number: 1762846-1 411-78201
	Part number: 1762950-1 411-78204
	Part number: 1762625-1 411-78194
Extraction tool part number: 1891526-1 411-78241	
D-1900 Extraction tool part number: 1891348-1 411-78263	

Material and Finish

Description	Material	Finish
Receptacle Contact Tab Contact	Copper alloy	Bright tin plating and gold plating (0.38 μm) with under-plated nickel (1.27 μm)
PCB Tab Post	Copper alloy	Gold plated 0.38 μm over nickel plated 1.27 μm Tab Post Tin plated 2.0 μm
Housing	UL94V-0, Thermoplastic PBT containing glasses	

Specifications Remember to obtain Instruction Sheets when you choose to use these tools. You can get electronic catalogue pages or instruction sheets on the Internet.

The safety specifications listed below are approved on specific part numbers. Please contact our Technical Support Centre to check whether the part numbers you use are approved or not. Keep in mind that there are instances where values differ from those given by Tyco Electronics Specifications.

Series	D-1100			D-1200 D-1500			D-1900																																								
	Voltage Rating	Current Rating	Temperature Rating	Voltage Rating	Current Rating	Temperature Rating	Voltage Rating	Current Rating	Temperature Rating																																						
Specifications 108-78268	125V AC/DC	3A (1 pos)	55 - 105	250V AC/DC	5A (1 pos)	55 - 105	150V AC/DC	4A	30 - 105																																						
UL File No.E28476	Based on requirements of machines used	Based on requirements of machines used	—	Based on requirements of machines used	Based on requirements of machines used	—	Based on requirements of machines used	Based on requirements of machines used	—																																						
CSA Report No.LR7189	125V AC/DC	3A	—	250V AC/DC	5A	—	150V AC/DC	4A (1 pos)	—																																						
TÜV	125V AC/DC	<table border="1"> <thead> <tr> <th>AWG</th> <th>A(1pos)</th> </tr> </thead> <tbody> <tr><td>22</td><td>3</td></tr> <tr><td>24</td><td>2.5</td></tr> <tr><td>26</td><td>2</td></tr> <tr><td>28</td><td>1.5</td></tr> <tr><td>30</td><td>1</td></tr> </tbody> </table>	AWG	A(1pos)	22	3	24	2.5	26	2	28	1.5	30	1	55 - 105	250V AC/DC	<table border="1"> <thead> <tr> <th>AWG</th> <th>A(1pos)</th> </tr> </thead> <tbody> <tr><td>18</td><td>5</td></tr> <tr><td>20</td><td>4</td></tr> <tr><td>22</td><td>3</td></tr> <tr><td>24</td><td>2.5</td></tr> <tr><td>26</td><td>2</td></tr> <tr><td>28</td><td>1.5</td></tr> <tr><td>30</td><td>1</td></tr> </tbody> </table>	AWG	A(1pos)	18	5	20	4	22	3	24	2.5	26	2	28	1.5	30	1	55 - 105	150V AC/DC	<table border="1"> <thead> <tr> <th>AWG</th> <th>A(1pos)</th> </tr> </thead> <tbody> <tr><td>18</td><td>4</td></tr> <tr><td>20</td><td>3</td></tr> <tr><td>22</td><td>2.5</td></tr> <tr><td>24</td><td>2</td></tr> </tbody> </table>	AWG	A(1pos)	18	4	20	3	22	2.5	24	2	30 - 105
AWG	A(1pos)																																														
22	3																																														
24	2.5																																														
26	2																																														
28	1.5																																														
30	1																																														
AWG	A(1pos)																																														
18	5																																														
20	4																																														
22	3																																														
24	2.5																																														
26	2																																														
28	1.5																																														
30	1																																														
AWG	A(1pos)																																														
18	4																																														
20	3																																														
22	2.5																																														
24	2																																														

Some part numbers are not available yet. Please contact our Sales Department for more information.

D-1000 Series Configurations

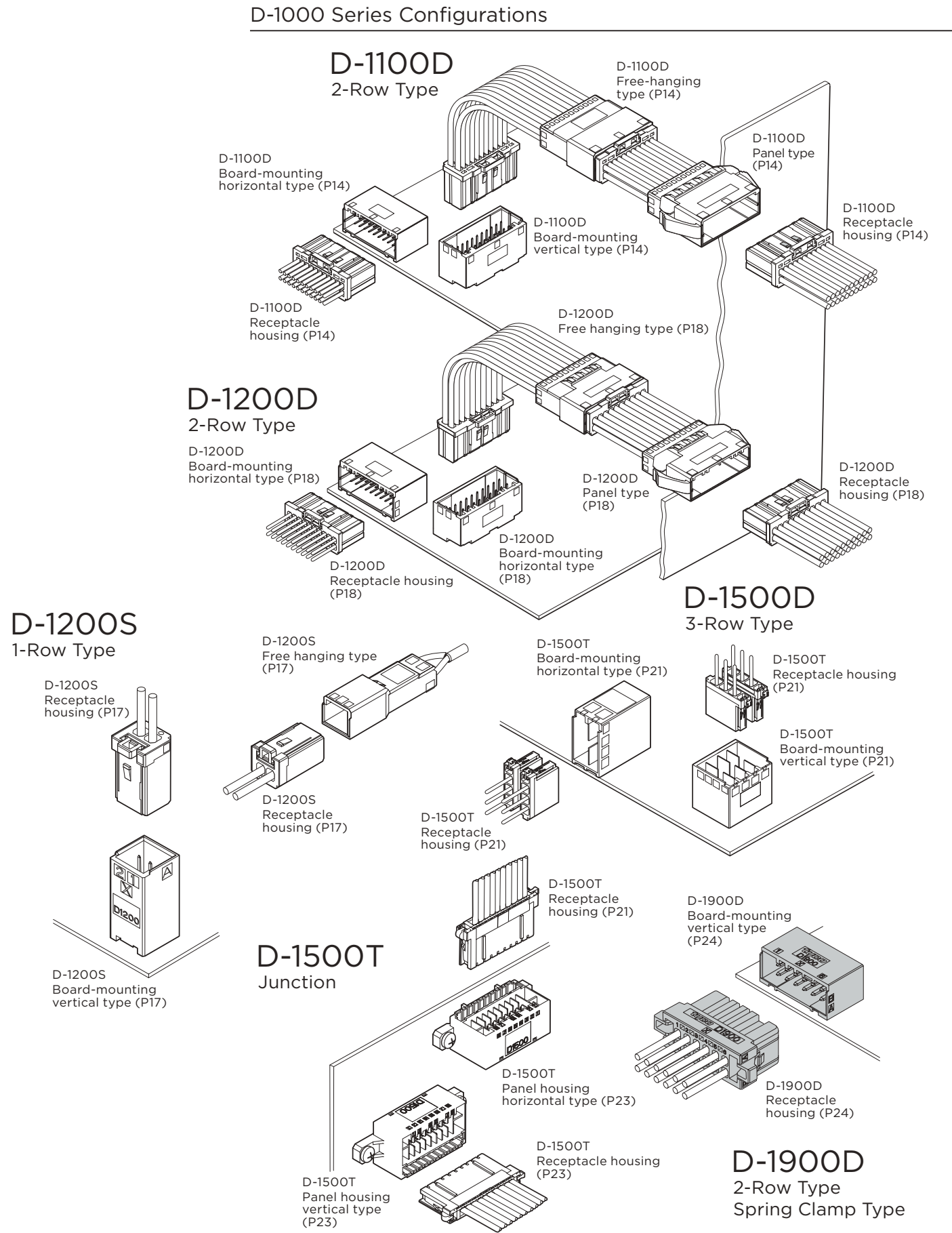

D-1000 Series

D-1000 Series

D-1000 Contact

•Crimp Types

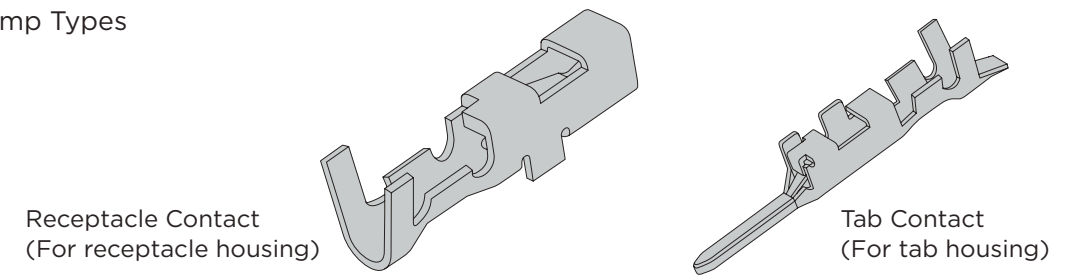

Wire Range		Insulation Range mm	Diameter Wire Range Mark	Models of Contacts				Models of Applicable tools		
AWG	mm ²			Receptacle Contact		Tab Contact		CCII Hand tool (PEW12 dies only) Mini Applicator	Tool numbers	
		Strip form	Loose piece	Strip form	Loose piece					
30	0.05	0.6-1.2	S	Gold plating	1827569-2	1827586-2	1903111-2	1903115-2	2119144-1 1762952-1 1762453-1	2114042-2
28	0.10			Tin plating	-	-	-	-		
28	0.08	1.08-1.6	M	Gold plating	1827570-2	1827587-2	1903112-2	1903116-2	2119141-1 1762846-1 1762847-1	2151082-1
26	0.12			Tin plating	1871303-1	1871743-1	1903120-1	1903124-1		
24	0.20									
22	0.37									
28	0.08	1.08-1.9	L	Gold plating	1827571-2	1827588-2	1903113-2	1903117-2	2119143-1 1762950-1 1762951-1	2114043-2
26	0.12			Tin plating	1871304-1	1871744-1	1903121-1	1903125-1		
24	0.20									
22	0.37									
22	0.34-0.37	1.4-2.2	2L	Gold plating	1827572-2	1827589-2	1903114-2	1903118-2	2119142-1 1762625-1 1762626-1	2151083-1
20	0.51-0.53			Tin plating	1871731-1	1871745-1	1903122-1	1903126-1		
18	0.85-0.87									

Remarks: When ordering, specify your requirements by multiplying the quality. Contact our Sales Department for more information.
Gold Plating: 0.38Qm
Tin Plating: 2.0Qm
For mini-applicators information, contact our Sales Department.

Keying plug: 1939588-1

Strip Form contacts are used with Mini-applicators (bench machine) and Loose-Piece contacts are for hand tools. The contacts L and 2L do not fit into the D-1100 receptacle housing and tab housing. With CCII hand tools (CERTI CRIMP11)

Flip Locator PEW12 dies interchangeable hand tools.
* Only the dies hand tools are available, part number 9-147824D-0

Receptacle contacts are only available for receptacle housings, while the tab contacts are only available for tab housings. Refer to pages after P.107 for details of applicable tools.

Note: All Part Numbers are RoHS compliant. You need to confirm LOT and lead time.

D-1100D 2-Row Standard Types

Part Number Chart

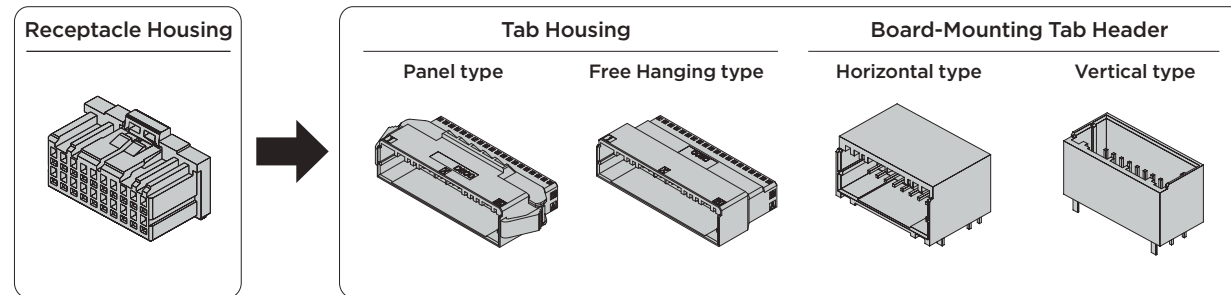

No. of Pos.	Color	Key	Receptacle Housing	Plating	Tab Housing		Board-Mounting Tab Header	
					Panel type	Free Hanging type	Horizontal type	Vertical type
10	Black	X	1-1827862-5	Gold	-	-	1-1827873-5	1-2040516-5
20	Black	X	1-1827862-0	Gold	-	-	1-1827873-0	-
22	Black	X	1-1827863-1	Gold	1-1903128-1	1-1903127-1	-	1-1827872-1
	Yellow	Y	3-1871057-1	Tin	-	-	-	3-1871056-1
26	Black	X	1-1827863-3	Gold	1-1903128-3	1-1903127-3	1-1939638-3	1-1827872-3
	Natural	-	1-1871057-3	Tin	-	-	-	1-1871056-3
	Black	Y	2-1827863-3	-	-	-	-	Pg 16 SMT Mate
28	Black	X	1-1827863-4	Gold	1-1903128-4	1-1903127-4	1-1939638-4	1-1827872-4
30	Black	X	1-1827863-5	Gold	-	-	-	1-1827872-5
	Natural	-	-	Tin	-	-	-	1-1871056-5
32	Black	X	1-1827863-6	Gold	1-1903128-6	1-1903127-6	-	1-1827872-6
	Red	-	5-1871057-6	Tin	-	-	-	5-1871056-6
34	Black	X	1-1827863-7	Gold	1-1903128-7	1-1903127-7	1-1939638-7	1-1827872-7
	Black	Y	2-1827863-7	Gold	-	-	-	2-1827872-7
40	Black	X	1-1827863-0	Gold	1-1903128-0	1-1903127-0	1-1939638-0	1-1827872-0
	-	-	-	Tin	-	-	-	1-1871315-0
	Natural	-	1-1871057-0	Tin	-	-	-	1-1871056-0
	Yellow	X	3-1871057-0	Tin	-	-	-	3-1871056-0
-	Red	-	5-1871057-0	Tin	-	-	-	5-1871056-0

Related product information

Application Contact ...P.13
Performance • Specifications ...P.11

Note: All Part Numbers are RoHS compliant.
You need to confirm LOT and lead time.

D-1100D 2-Row Standard Types

Fitting Dimensions

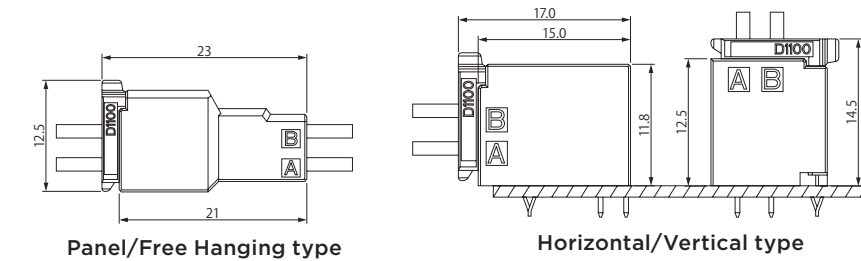

External Dimensions

• Receptacle Housing

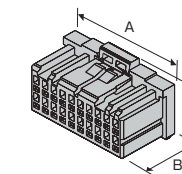

No. of Pos.	Keying	Plating	Color	Part Number	Dimensions		
					A	B	C
10	X	-	Black	1-1827862-5	12.6	11.3	12.5
20	X	-	Black	1-1827862-0	22.6	11.3	12.5
22	X	-	Black	1-1827863-1	24.6	11.3	12.5
			Natural	-			
			Yellow	3-1871057-1			
26	X	-	Black	1-1827863-3	28.6	11.3	12.5
			Natural	1-1871057-3			
			Black	2-1827863-3			
28	X	-	Black	1-1827863-4	30.6	11.3	12.5
			Red	-			
30	X	-	Black	1-1827863-5	32.6	11.3	12.5
			Natural	-			
			Yellow	-			
32	X	-	Black	1-1827863-6	34.6	11.3	12.5
			Natural	-			
			Red	5-1871057-6			
34	X	-	Black	1-1827863-7	36.6	11.3	12.5
	Y	-	Black	2-1827863-7			
40	X	-	Black	1-1827863-0	42.6	11.3	12.5
			Natural	1-1871057-0			
			Yellow	3-1871057-0			
			Red	5-1871057-0			

• Tab Housing

Panel type

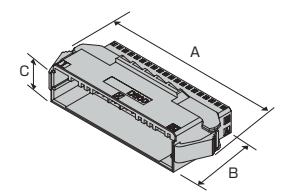

No. of Pos.	Keying	Plating	Color	Part Number	Dimensions		
					A	B	C
22	X	-	Black	1-1903128-1	34.1	21.0	13.9
26	X	-	Black	1-1903128-3	38.1	21.0	13.9
28	X	-	Black	1-1903128-4	40.1	21.0	13.9
32	X	-	Black	1-1903128-6	44.1	21.0	13.9
34	X	-	Black	1-1903128-7	46.1	21.0	13.9
40	X	-	Black	1-1903128-0	52.1	21.0	13.9

Free Hanging type

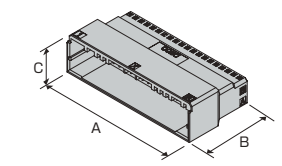

No. of Pos.	Keying	Plating	Color	Part Number	Dimensions		
					A	B	C
22	X	-	Black	1-1903127-1	24.6	21.0	11.3
26	X	-	Black	1-1903127-3	28.6	21.0	11.3
28	X	-	Black	1-1903127-4	30.6	21.0	11.3
32	X	-	Black	1-1903127-6	34.6	21.0	11.3
34	X	-	Black	1-1903127-7	36.6	21.0	11.3
40	X	-	Black	1-1903127-0	42.6	21.0	11.3

Note: All Part Numbers are RoHS compliant.
You need to confirm LOT and lead time.

D-1100D 2-Row Standard Types

• Board-Mounting Tab Header

Horizontal type

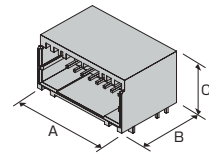

No. of Pos.	Keying	Plating	Color	Part Number	Dimensions		
					A	B	C
10	X	Gold	Black	1-1827873-5	12.6	15.0	11.8
20	X	Gold	Black	1-1827873-0	22.6	15.0	11.8
26	X	Gold	Black	1-1939638-3	28.6	15.0	11.8
28	X	Gold	Black	1-1939638-4	30.6	15.0	11.8
30	X	Tin	Yellow	-	32.6	15.0	11.8
34	X	Gold	Black	1-1939638-7	36.6	15.0	11.8
40	X	Gold	Black	1-1939638-0	42.6	15.0	11.8

Vertical type

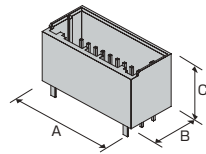

No. of Pos.	Keying	Plating	Color	Part Number	Dimensions		
					A	B	C
10	X	Gold	Black	1-2040516-5	12.6	11.3	12.5
22	X	Gold	Black	1-1827872-1	24.6	11.3	12.5
		Tin	Yellow	3-1871056-1			
26	X	Gold	Black	1-1827872-3	28.6	11.3	12.5
		Tin	Natural	1-1871056-3			
28	X	Gold	Black	1-1827872-4	30.6	11.3	12.5
		Tin	Red	-			
30	X	Gold	Black	1-1827872-5	32.6	11.3	12.5
		Tin	Black	-			
		Tin	Natural	1-1871056-5			
32	X	Gold	Black	1-1827872-6	34.6	11.3	12.5
		Tin	Natural	-			
		Tin	Red	5-1871056-6			
34	X	Gold	Black	1-1827872-7	36.6	11.3	12.5
	Y	Gold	Black	2-1827872-7			
40	X	Gold	Black	1-1827872-0	42.6	11.3	12.5
		Tin	Black	1-1871315-0			
	X	Tin	Natural	1-1871056-0			
		Tin	Yellow	3-1871056-0			
		Tin	Red	5-1871056-0			

SMT Type

• Board-Mounting Tab Header

Vertical type

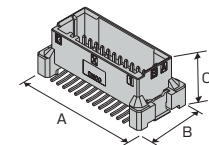

No. of Pos.	Keying	Plating	Color	Part Number	Dimensions		
					A	B	C
26	X	Gold	Black	1-1939995-3	34.6	16.3	13.5
	Y	Gold	Black	2-1939995-3			
40	X	Gold	Black	1-1939995-0	48.6	16.3	13.5
	Y	Gold	Black	2-1939995-0			

Note: All Part Numbers are RoHS compliant. You need to confirm LOT and lead time.

D-1200 Single Row/High Voltage Types

Part Number Chart

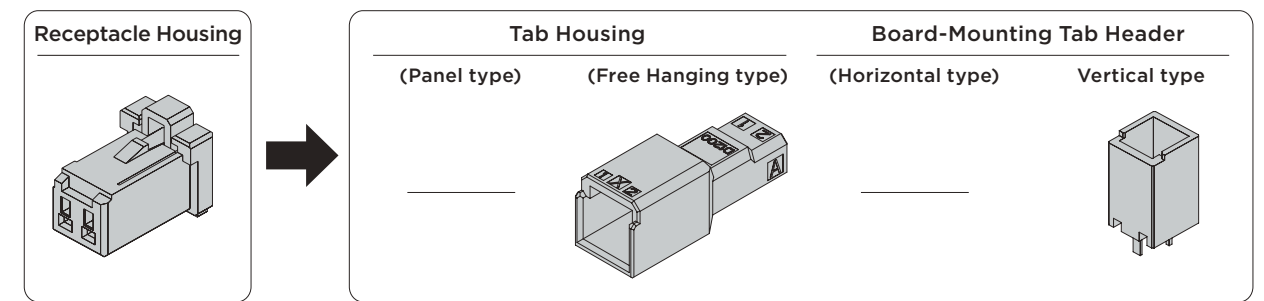

No. of Pos.	Color	Keying	Receptacle Housing	Plating	Tab Housing		Board-Mounting Tab Header	
					Panel type	Free Hanging type	Horizontal type	Vertical type
2	Black	X	1-1871465-2	Gold	-	1-1903129-2	-	1-1871468-2
	-	Y	-	-	-	-	-	-

Related product information

Application Contact ...P.13
Performance • Specifications ...P.11

Fitting Dimensions

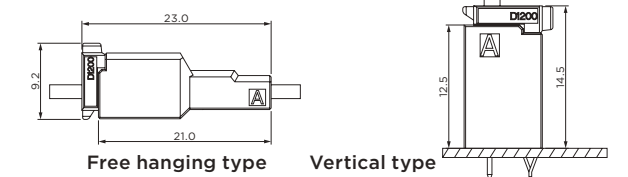

External Dimensions

• Receptacle Housing

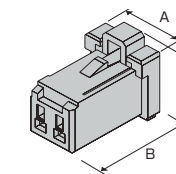

No. of Pos.	Keying	Plating	Color	Part Number	Dimensions		
					A	B	C
2	X	-	Black	1-1871465-2	7.6	11.3	9.2

• Tab Housing

Free Hanging type

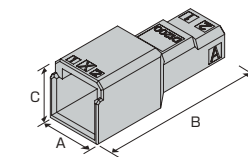

No. of Pos.	Keying	Plating	Color	Part Number	Dimensions		
					A	B	C
2	X	-	Black	1-1903129-2	7.6	21.0	8.0

Note: All Part Numbers are RoHS compliant.

• Board-Mounting Tab Header

Vertical type

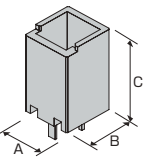

No. of Pos.	Keying	Plating	Color	Part Number	Dimensions		
					A	B	C
2	X	Gold	Black	1-1871468-2	7.6	8.0	12.5

D-1200 Single Row/High Voltage Types

Part Number Chart

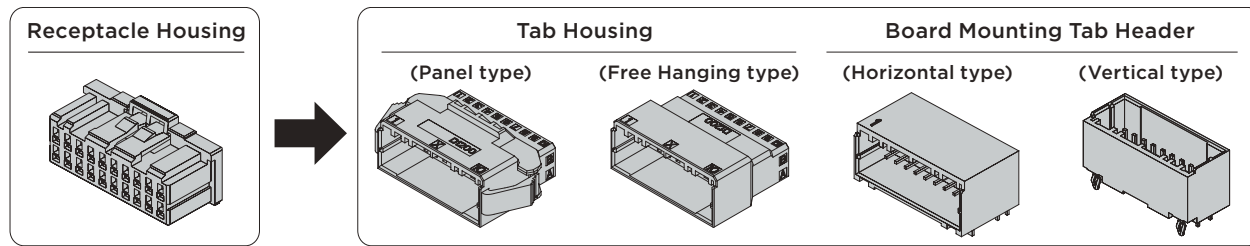

No of Pos.	Color	Keying	Part Number	Plating	Tab Housing		Board-Mounting Tab Header	
					Panel type	Free Hanging type	Horizontal type	Vertical type
4	Black	X	1-1827864-2	Gold Tin	1-1903131-2	1-1903130-2	1-1827876-2	1-1827875-2
	Natural		1-1939028-2	Gold	-	-	1-1871673-2	-
	Yellow		-	-	-	-	1-1939818-2	1-1939261-2
	Black	Y	2-1827864-2	Gold	-	-	2-1827876-2	2-1827875-2
	Natural		2-1939028-2	Gold	-	-	2-1939818-2	2-1939261-2
	Yellow		4-1939028-2	Gold	-	-	4-1939818-2	4-1939261-2
6	Black	X	1-1827864-3	Gold	1-1903131-3	1-1903130-3	1-1827876-3	1-1827875-3
	Black		-	Tin	-	-	-	1-2040558-3
	Natural		1-1939028-3	Gold	-	1-1939796-3	1-1939818-3	1-1939261-3
	Yellow	3-1939028-3	Gold	-	-	3-1939818-3	3-1939261-3	
	Black	Y	2-1827864-3	Gold	2-1903131-3	2-1903130-3	2-1827876-3	2-1827875-3
	Natural		2-1939028-3	Gold	-	2-1939796-3	2-1939818-3	2-1939261-3
Yellow	4-1939028-3		Gold	-	-	4-1939818-3	4-1939261-3	
8	Black	X	1-1827864-4	Gold	1-1903131-4	1-1903130-4	1-1827876-4	1-1827875-4
	Natural		1-1939028-4	Gold	-	-	1-1939818-4	1-1939261-4
	Black	Y	2-1827864-4	Gold	2-1903131-4	2-1903130-4	2-1827876-4	2-1827875-4
	Natural		-	-	-	-	-	-
10	Black	X	1-1827864-5	Gold	-	-	-	1-1827875-5
	Natural		1-1939028-5	Gold	-	-	-	1-1939261-5
	Black	Y	2-1827864-5	Gold	-	-	-	2-1827875-5
12	Black	X	1-1827864-6	Gold Tin	1-1903131-6	1-1903130-6	1-1827876-6	1-1827875-6
	Black		Y	2-1827864-6	Gold	-	-	2-1827876-6
20	Black	X	1-1827864-0	Gold	1-1903131-0	1-1903130-0	1-1827876-0	1-1827875-0
	Black	Y	2-1827864-0	Gold	2-1903131-0	2-1903130-0	2-1827876-0	2-1827875-0

Related product information

Application Contact ...P.13
Performance • Specifications ...P.11

Note: All Part Numbers are RoHS compliant.
You need to confirm LOT and lead time.

D-1200D 2 Row High Voltage Types

Fitting Dimensions

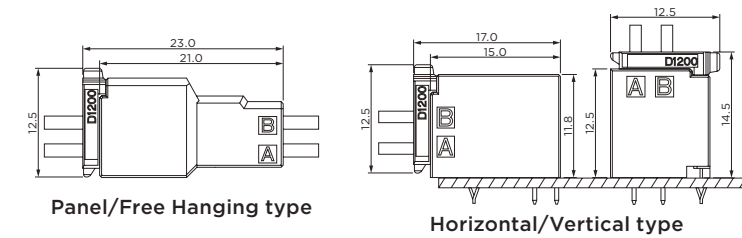

External Dimensions

• Receptacle Housing

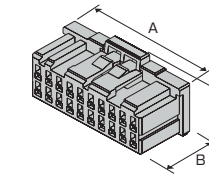

No.of Pos.	Keying	Plating	Color	Part number	Dimensions		
					A	B	C
4	X	-	Black	1-1827864-2	7.6	11.3	12.5
		-	Natural	1-1939028-2			
	Y	-	Black	2-1827864-2			
		-	Natural	2-1939028-2			
6	X	-	Black	1-1827864-3	10.1	11.3	12.5
		-	Natural	1-1939028-3			
	Y	-	Black	2-1827864-3			
		-	Natural	2-1939028-3			
8	X	-	Black	1-1827864-4	12.6	11.3	12.5
		-	Natural	1-1939028-4			
	Y	-	Black	2-1827864-4			
		-	Natural	2-1939028-4			
10	X	-	Black	1-1827864-5	15.1	11.3	12.5
		-	Natural	1-1939028-5			
	Y	-	Black	2-1827864-5			
		-	Natural	2-1939028-5			
12	X	-	Black	1-1827864-6	17.6	11.3	12.5
		-	Black	2-1827864-6			
	Y	-	Black	2-1827864-6			
		-	Black	2-1827864-6			
20	X	-	Black	1-1827864-0	27.6	11.3	12.5
		-	Black	2-1827864-0			
	Y	-	Black	2-1827864-0			
		-	Black	2-1827864-0			

• Tab Housing
Panel type

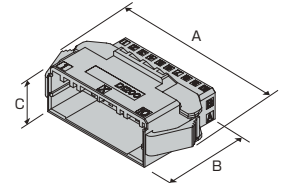

No.of Pos.	Keying	Plating	Color	Part number	Dimensions		
					A	B	C
4	X	-	Black	1-1903131-2	17.1	21.0	13.9
6	X	-	Black	1-1903131-3	19.6	21.0	13.9
				2-1903131-3			
8	X	-	Black	1-1903131-4	22.1	21.0	13.9
				2-1903131-4			
12	X	-	Black	1-1903131-6	27.1	21.0	13.9
20	X	-	Black	1-1903131-0	37.1	21.0	13.9
				2-1903131-0			

Free Hanging type

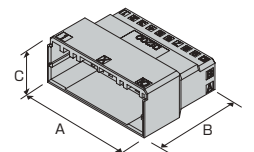

No.of Pos.	Keying	Plating	Color	Part number	Dimensions		
					A	B	C
4	X	-	Black	1-1903130-2	7.6	21.0	11.3
6	X	-	Black	1-1903130-3	10.1	21.0	11.3
				1-1939796-3			
	Y	-	Black	2-1903130-3			
				2-1939796-3			
8	X	-	Black	1-1903130-4	12.6	21.0	11.3
				2-1903130-4			
12	X	-	Black	1-1903130-6	17.6	21.0	11.3
20	X	-	Black	1-1903130-0	27.6	21.0	11.3
				2-1903130-0			

Note: All Part Numbers are RoHS compliant.
You need to confirm LOT and lead time.

D-1200D 2 Row High Voltage Types

• Board-Mounting Tab Header

Horizontal types

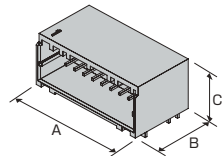

Vertical types

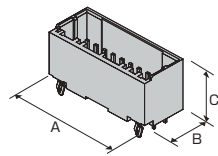

No. of Pos.	Keying	Plating	Color	Part number	Dimensions		
					A	B	C
4	X	Gold	Black	1-1827876-2	7.6	15.0	11.8
		Tin	Black	1-1871673-2			
		Gold	Natural	1-1939818-2			
	Y	Gold	Yellow	3-1939818-2			
		Gold	Black	2-1827876-2			
		Gold	Natural	2-1939818-2			
6	X	Gold	Black	1-1827876-3	10.1	15.0	11.8
		Gold	Natural	1-1939818-3			
		Gold	Yellow	3-1939818-3			
	Y	Gold	Black	2-1827876-3			
		Gold	Natural	2-1939818-3			
		Gold	Yellow	4-1939818-3			
8	X	Gold	Black	1-1827876-4	12.6	15.0	11.8
	Y	Gold	Natural	1-1939818-4			
12	X	Gold	Black	1-1827876-6	17.6	15.0	11.8
	Y	Gold	Natural	1-1939818-6			
20	X	Gold	Black	1-1827876-0	27.6	15.0	11.8
	Y	Gold	Black	2-1827876-0			

No. of Pos.	Keying	Plating	Color	Part number	Dimensions		
					A	B	C
4	X	Gold	Black	1-1827875-2	7.6	11.3	12.5
		Gold	Natural	1-1939261-2			
		Gold	Yellow	3-1939261-2			
	Y	Gold	Black	2-1827875-2			
		Gold	Natural	2-1939261-2			
		Gold	Yellow	4-1939261-2			
6	X	Gold	Black	1-1827875-3	10.1	11.3	12.5
		Tin	Black	1-2040558-3			
		Gold	Natural	1-1939261-3			
	Y	Gold	Yellow	3-1939261-3			
		Gold	Black	2-1827875-3			
		Gold	Natural	2-1939261-3			
8	X	Gold	Black	1-1827875-4	12.6	11.3	12.5
	Y	Gold	Natural	1-1939261-4			
10	X	Gold	Black	2-1827875-4	15.1	11.3	12.5
	Y	Gold	Natural	1-1939261-5			
12	X	Gold	Black	1-1827875-5	17.6	11.3	12.5
	Y	Gold	Black	2-1827875-5			
20	X	Gold	Black	1-1827875-6	27.6	11.3	12.5
	Y	Gold	Black	2-1827875-6			

SMT Type

• Board-Mounting Tab Header

Vertical type

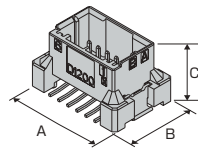

No. of Pos.	Keying	Plating	Color	Part number	Dimensions		
					A	B	C
12	X	Gold	Black	1-2013407-6	23.6	16.3	13.5

Note: All Part Numbers are RoHS compliant. You need to confirm LOT and lead time.

D1500T 3 Row High Voltage Modular Type

Part Number Chart

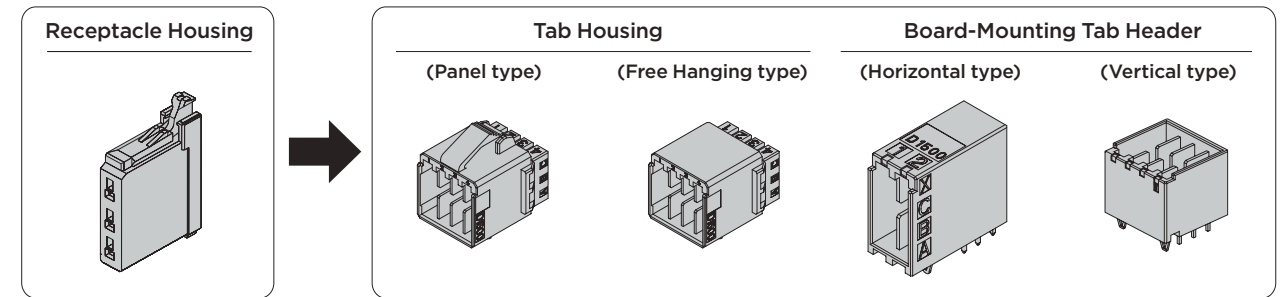

No. of Pos.	Color	Keying	Receptacle housing	Plating	Tab housing		Board-mounting tab header	
					Panel type	Free hanging type	Horizontal type	Vertical type
3	Black	X	1-1827579-1	Gold	-	1-2040444-1	-	1-1827581-1
6	Black	X	1-2069029-2	Gold	1-2040404-2	1-2040444-2	1-1827583-2	1-1827581-2
9	Black	X	1-2069029-3	Gold	1-2040404-3	1-2040444-3	-	1-1827581-3
12	Black	X	1-2069029-4	Gold	1-2040404-4	1-2040444-4	-	1-1827581-4
36	Black	X	-	Gold	3-2040404-2	-	-	-

Related product information

Application Contact ...P.13
Performance • Specifications ...P.11

Dimensions

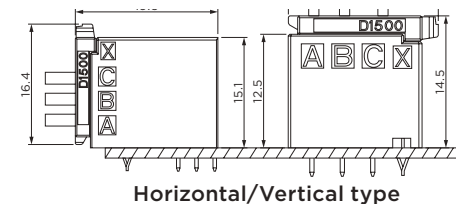

• Receptacle Housing

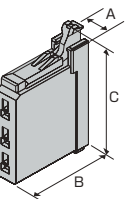

No. of Pos.	Keying	Plating	Color	Part number	Dimensions		
					A	B	C
3	X	-	Black	1-1827579-1	3.3	11.3	16.4
6	X	-	Black	1-2069029-2	6.8	11.3	16.4
9	X	-	Black	1-2069029-3	10.3	11.3	16.4
12	X	-	Black	1-2069029-4	13.8	11.3	16.4

Note: All Part Numbers are RoHS compliant. You need to confirm LOT and lead time.

D-1500T Series 3-Row High Voltage Modular Type

External Dimensions

- Tab Housing
Panel type

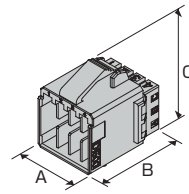

No. of Pos.	Keying	Plating	Color	Part number	Dimensions		
					A	B	C
6	X	-	Black	1-2040404-2	8.5	21.0	24.5
9	X	-	Black	1-2040404-3	12.0	21.0	24.5
12	X	-	Black	1-2040404-4	15.5	21.0	24.5
36	X	-	Black	3-2040404-2	43.5	21.0	24.5

- Tab Housing
Free hanging type

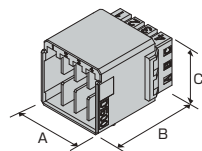

No. of Pos.	Keying	Plating	Color	Part number	Dimensions		
					A	B	C
3	X	-	Black	1-2040444-1	3.0	21.0	15.0
6	X	-	Black	1-2040444-2	6.5	21.0	15.0
9	X	-	Black	1-2040444-3	10.0	21.0	15.0
12	X	-	Black	1-2040444-4	13.5	21.0	15.0

- PCB Mounting Tab Header
Horizontal type

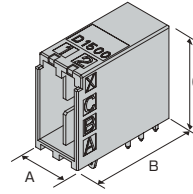

No. of Pos.	Keying	Plating	Color	Part number	Dimensions		
					A	B	C
6	X	Gold	Black	1-1827583-2	8.1	17.5	15.1

- PCB Mounting Tab Header
Vertical type

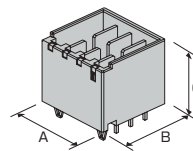

No. of Pos.	Keying	Plating	Color	Part number	Dimensions		
					A	B	C
3	X	Gold	Black	1-1827581-1	4.6	14.6	12.5
6	X	Gold	Black	1-1827581-2	8.1	14.6	12.5
9	X	Gold	Black	1-1827581-3	11.6	14.6	12.5
12	X	Gold	Black	1-1827581-4	15.1	14.6	12.5

NOTE: All products are RoHS compliant On selection. You need to confirm LOT and lead time

D-1500T Junction box

Part Number Chart

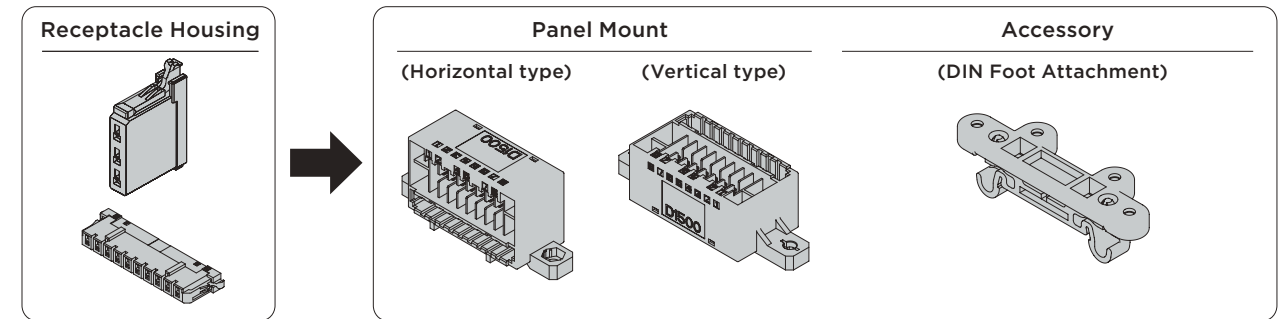

No. of Pos.	Color	Keying	Receptacle Housing	Plating	Panel Mount		Accessory
					Horizontal type	Vertical type	DIN foot attachment kit
3	Black	X	1-1827579-1	-	-	-	-
10	Black	-	1971150-1	-	-	-	-
34	Black	-	-	Gold	1971151-1	1971151-2	1971182-1*

*DIN Foot Attachment Kit contents as follows

- DIN Foot Attachment x1
- M3 Fixing Screw x4

Related product information

Application Contact ...P.13
Performance • Specifications ...P.11

External dimensions

- Receptacle Housing

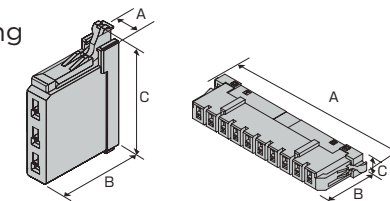

No. of Pos.	Keying	Plating	Color	Part number	Dimensions		
					A	B	C
3	X	-	Black	1-1827579-1	3.3	11.3	16.4
10	-	-	Black	1971150-1	42.2	11.3	4.6

- Panel Mount
Horizontal type

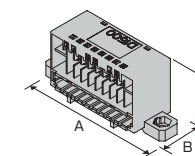

No. of Pos.	Keying	Plating	Color	Part number	Dimensions		
					A	B	C
34	-	Gold	Black	1971151-1	57.7	18.7	24.6

NOTE: All products are RoHS compliant On selection. You need to confirm LOT and lead time

- Vertical type

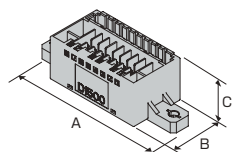

No. of Pos.	Keying	Plating	Color	Part number	Dimensions		
					A	B	C
34	-	Gold	Black	1971151-2	64.8	22.8	18.2

- Accessory
DIN Foot Attachment Kit

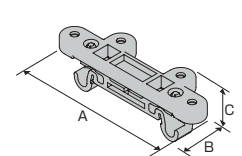

No. of Pos.	Keying	Plating	Color	Part number	Dimensions		
					A	B	C
-	-	-	Black	1971182-1	67.5	19.0	18.1

D-1900D 2-Row Spring Clamp type

Part Number Chart

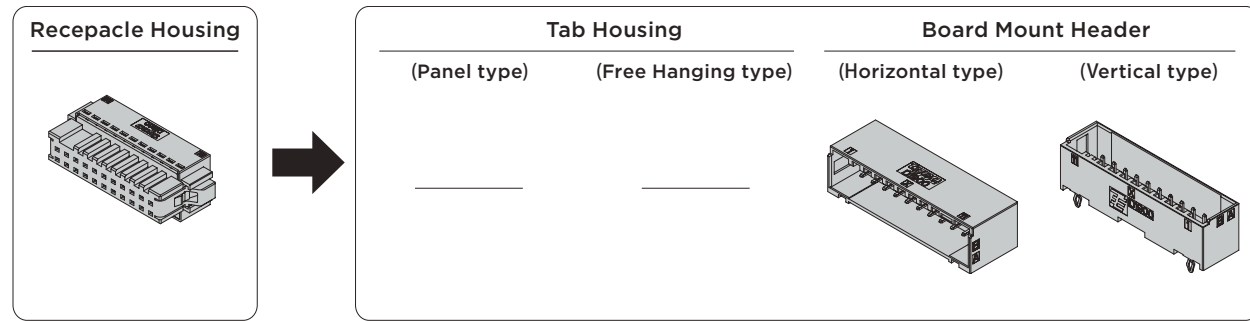

No of Pos.	Color	Keying	Receptacle Assembly	Tab Housing		Board Mount Header	
			Spring Clamp	Panel type	Free Hanging type	Horizontal type	Vertical type
8	Black	X	1-1871940-4	-	-	1-1871935-4	1-2013325-4
12	Black	X	1-1871940-6	-	-	1-1871935-6	1-2013325-6
16	Black	X	1-1871940-8	-	-	1-1871935-8	-
22	Black	X	2-1871940-1	-	-	2-1871935-1	2-2013325-1
30	Black	X	2-1871940-5	-	-	2-1871935-5	-
38	Black	X	2-1871940-9	-	-	2-1871935-9	-

Related product information

Application Contact ...P.13
Performance • Specifications ...P.11

Mating Dimension

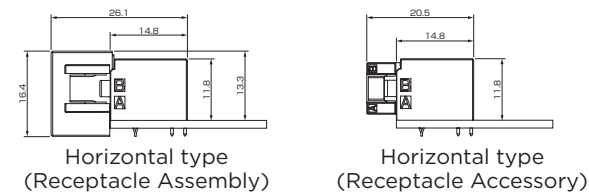

External Dimensions

• Receptacle Assembly (Spring Clamp)

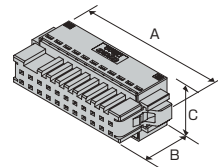

No. of Pos.	Keying	Plating	Color	Part number	Dimensions		
					A	B	C
8	X	Gold	Black	1-1871940-4	25.2	20.6	16.4
12	X	Gold	Black	1-1871940-6	32.2	20.6	16.4
16	X	Gold	Black	1-1871940-8	39.2	20.6	16.4
22	X	Gold	Black	2-1871940-1	49.7	20.6	16.4
30	X	Gold	Black	2-1871940-5	63.7	20.6	16.4
38	X	Gold	Black	2-1871940-9	77.7	20.6	16.4

• Bound Mount Header Horizontal type

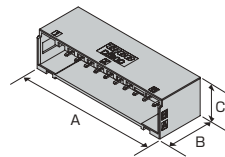

No. of Pos.	Keying	Plating	Color	Part number	Dimensions		
					A	B	C
8	X	Gold	Black	1-1871935-4	19.8	14.8	11.8
12	X	Gold	Black	1-1871935-6	26.8	14.8	11.8
16	X	Gold	Black	1-1871935-8	33.8	14.8	11.8
22	X	Gold	Black	2-1871935-1	44.3	14.8	11.8
30	X	Gold	Black	2-1871935-5	58.3	14.8	11.8
38	X	Gold	Black	2-1871935-9	72.3	14.8	11.8

Vertical type

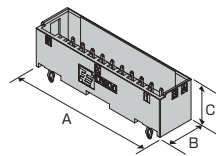

No. of Pos.	Keying	Plating	Color	Part number	Dimensions		
					A	B	C
8	X	Gold	Black	1-2013325-4	20.2	11.5	12.5
12	X	Gold	Black	1-2013325-6	26.8	11.5	12.5
22	X	Gold	Black	2-2013325-1	44.3	11.5	12.5

You need to confirm LOT and lead time

D-2000 Series

Series Introduction

The D-2000 series is a compact connector in the Dynamic series and has the specifications for industrial machinery. Its proprietary concept long contact wiping length provides the high-reliability needed for industrial machinery. The line-up also includes the multi-position drawer type not found in any other series and the hybrid type that integrates signal and power lines in a single connector.

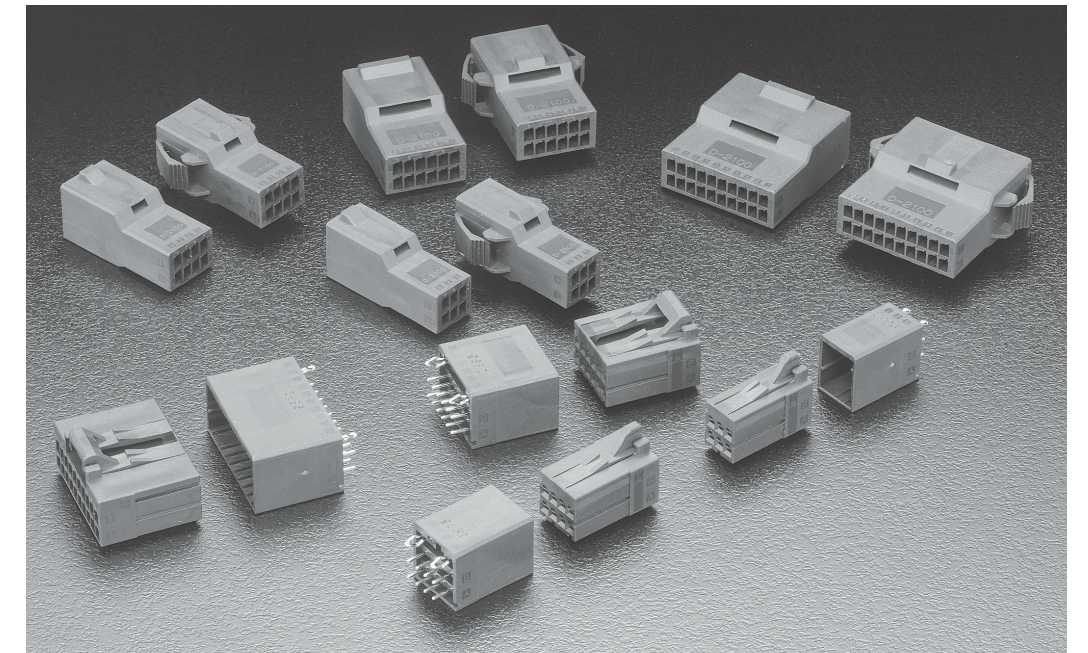

Features

- Terminal and Housing Construction are Twist Resistant**
The box shape receptacle contact is highly resistant to twisting and the housing slit also prevents angled mating to increase reliability.
- Contact Wiping Length**
Attaining the reliability needed for industrial machinery in a compact size by using a long contact wiping length.
- Wire Sizes:**
With its 2.5 mm pitch, it is a compact series, yet it can use 18 AWG wires, which are often used in industrial equipment.
- Audible Latching**
Obvious lock sound and feeling when mating means work can be done without mistakes, such as mismatching (half-mating), even if the connection cannot be seen.
- Keying**
The housing is keyed (with a slit), so differentiating between X keys and Y keys prevents mismatching. It is also possible to make more key patterns by using keying plugs.
- Center Locking**
This is the first application of a center lock in the Dynamic series. On-board space requirements can be minimized because these connectors can be mounted in a tight space for high-density mounting on boards requiring signal lines.
- Drawer Type**
The drawer type connector was developed with a floating construction on one side for applications where it is not possible to see the connection. There can be up to 50 positions, the highest in the series. These connectors make it possible to make connections between units without looking.
- Hybrid Type**
For signal lines use the D-2000 connector, for power lines use the D-3000 connector. The D-2600 series combines signal and power lines in a single connector. This cuts on-board space requirements and improves maintenance.

D-2000 Series Performance Specifications and Standards

Performance Specifications

Item	2100S/D	2100M	2600D
Pitch	2.5mm		
Current Rating	5A max	2.6A max	3.2A max
Voltage Rating	250V AC/DC		
Dielectric Withstanding Voltage	1500V AC	2300V AC	1500V AC
Total Resistance	5mΩ max (initial) 10mΩ max (final)		
Insertion Strength	4.9N max (per pole)		
Withdrawal strength	0.29N max (per pole)		
Durability	500 times		
Lock Strength	39.2N min	-	98N min

No. of Pos/Wire size/Current rating D-2100S/D value

No. of pos	Wire size					
	#18	#20	#22	#24	#26	#28
3	5	4.5	4.3	3.3	2.9	2.3
6	5	4.2	4	2.7	2.5	2
8	4.5	4	3.5	2.5	2.2	1.8
12	4	3.5	3	2.3	1.9	1.5
16	3.2	2.8	2.4	2	1.6	1.2
20	3.2	2.8	2.4	2	1.6	1.2

Product Specifications Manual Materials & Construction

Series name	D-2100S/D	D-2100M	D-2600D
Product standards	108-5619	108-5659	108-78301
Application Spec	114-5258		
Instruction Sheet (Hand Tool)	411-5897		
Instruction Sheet (Extraction Tool PN)	411-5900 (1276716-1)		

Materials and Plating

Category	Material	Completion
Receptacle Contact Tab Contact	Copper alloy	Nickel undercoat gold plating (0.38μm)
Board side Tab post	Copper alloy	Tin plating and nickel undercoat gold plating (0.38μm)
Housing	UL94V-0 glass-reinforced thermoplastic PBT	

Please refer to the standards on P. 35 for the D-3000 contact used in D-2600D
Please refer to the manual when using the product. An e-Catalogue is also available for download from the Internet.

Safety Standards

The following safety standards have been approved depending on model number. Please check each model number to see if it has been approved or not. Also, please be aware that these may not match TE's own performance specifications.

Standards	Series	D-2100 series			D-2100M drawer type		
		Current Rating	Voltage rating	Temperature rating	Current rating	Voltage rating	Temperature rating
Product standards 108-5619 general 108-5659 drawer type		250V AC/DC	5A 1 pole	-55°C-+105°C	250V AC/DC	2.6A AWG#20 hours 50 pole load	-5°C-+105°C
UL File No.E28476		Determined according to the requirements of the machine in use	Determined according to the requirements of the machine in use	-	Determined according to the requirements of the machine in use	Determined according to the requirements of the machine in use	-
CSA Report No. LR 7189		250V AC/DC	AWG#24-#28: 3.3A AWG#18-#22: 5A	-	250V AC/DC	max 5A per pole	-
TÜV License No. R 9950679		125V AC/DC	5A	-55°C-+105°C	125V AC/DC	max 5A per pole	-5°C-+105°C

D-2000 Series Configurations

D-2100S
1 row type

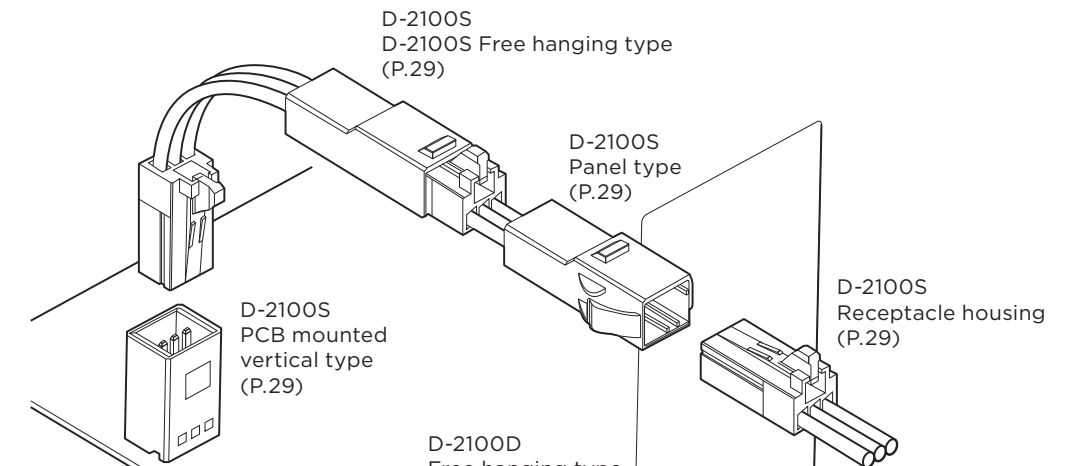

D-2100D
2 row type

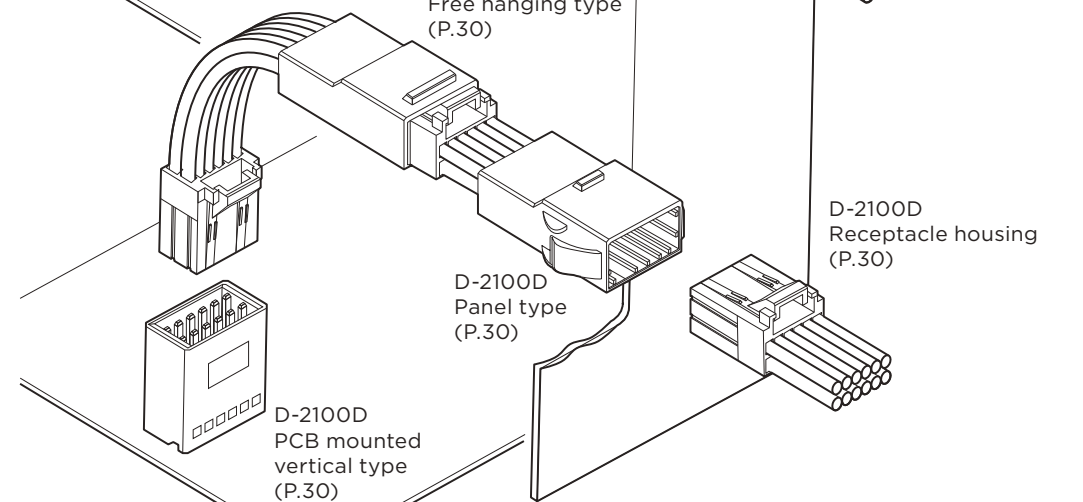

D-2100M
Drawer type

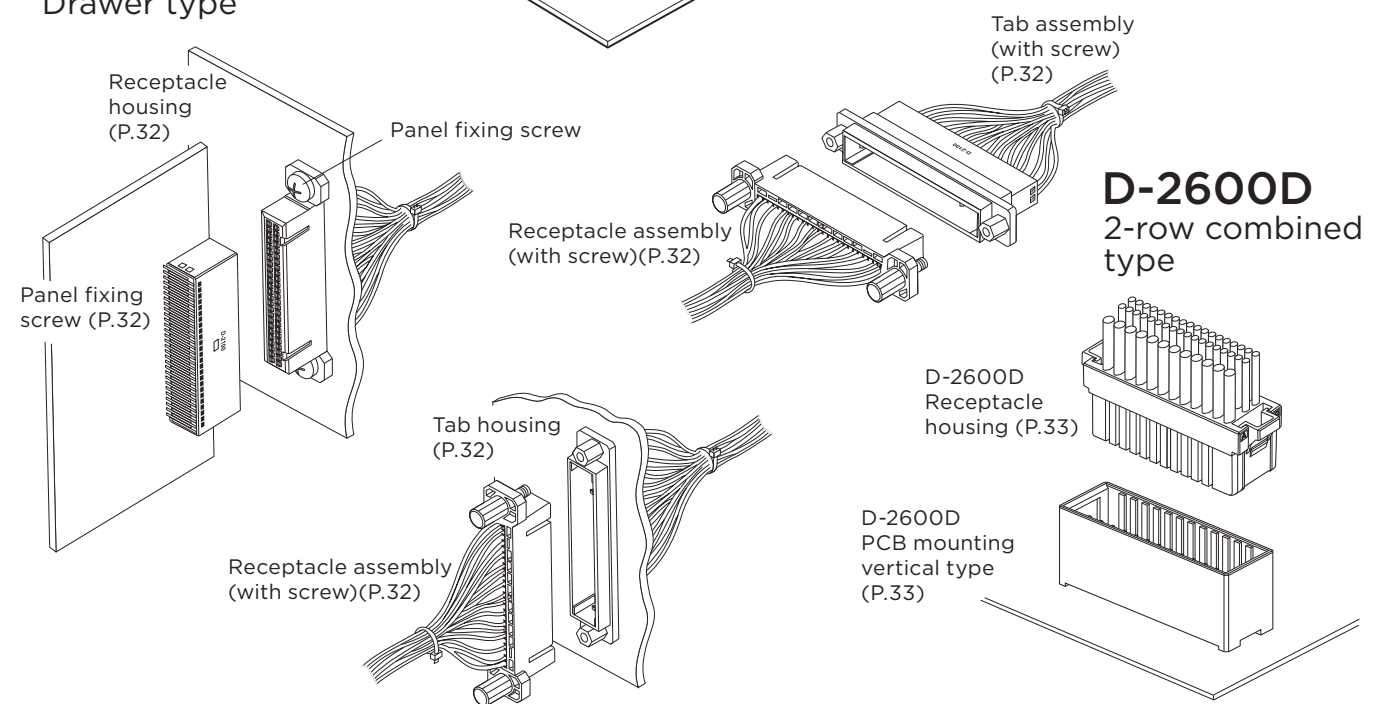

D-2000 Series

D-2000 Series

D-2000 Series Contact

- Crimped type (gold plating thickness 0.38 μ m)

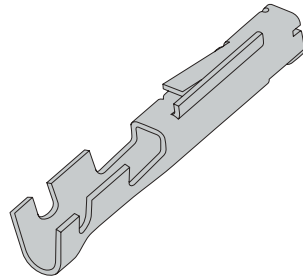

Receptacle Contact
• used in receptacle housing

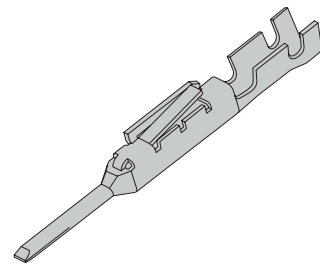

Tab Contact
• used in tab housing

Applicable Wiring Range		Insulation Wire Outer Diameter mm	Wire Range Mark	Contact Part Number				Applicable Tool Part Number	
AWG	mm ²			Receptacle Contact		Tab Contact		Hand Tool	Mini Applicator
				Strip Form	Loose Piece	Strip Form	Loose Piece		
28	0.09	0.88-1.3	S	1318106-1	1318108-1	1318110-1	1318112-1	91576-1	2151240-1
26	0.12								
24	0.20	1.11-1.43							
22	0.30	1.26-1.8	M	1318105-1	1318107-1	1318109-1	1318111-1	91595-1	2151071-1
20	0.50								
18	0.85								

Note: When placing your order, please check with the confirmed sales slots. Please contact our sales department or purchase distributor for more information.

For mini applicator, please contact with the sales department.

The receptacle contact can be used in all receptacle housings, the tab contact can be used in all tab housings. Details of the applicable tools are available from P. 107

NOTE: All products are RoHS compliant On selection. You need to confirm LOT and lead time

D-2100S 1-Row Standard Type

Part Number Chart

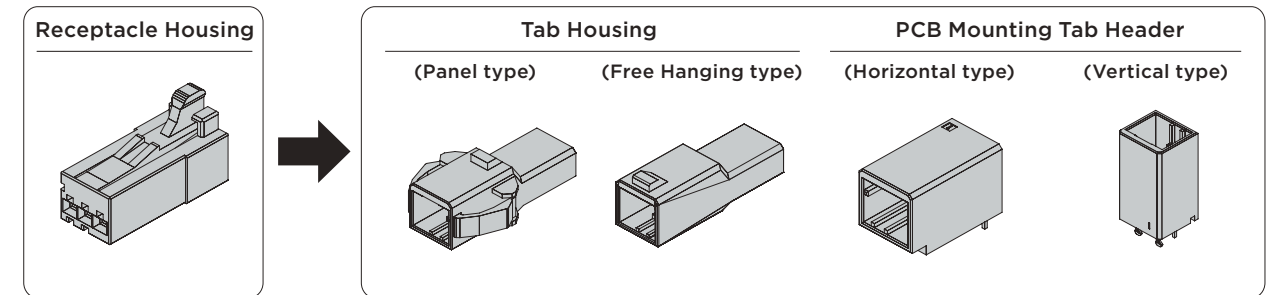

No. of Pos.	Color	Key	Receptacle Housing	Plating	Tab Housing		PCB Mounting Tab Header	
					Panel type	Free Hanging type	Horizontal type	Vertical type
3	Black	X	1-1318120-3		1-1318116-3	1-1318117-3	1376135-1	1318123-1
	Black	Y	2-1318120-3		2-1318116-3	2-1318117-3	1376135-2	1318123-2
	Black	Z	3-1318120-3	Gold	-	-	1376135-3	-
	Black	X	1-1473074-3	Gold	-	-	-	1-1318123-1

The * mark means drawer type

Related product information

Application Contact ...P.28
Performance • Specifications ...P.26

Mating Dimension

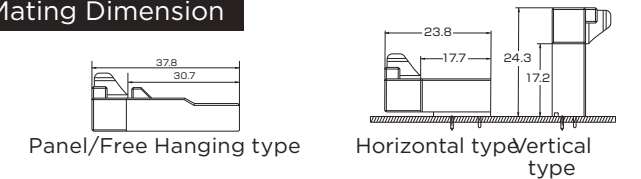

External Dimension

- Receptacle Housing

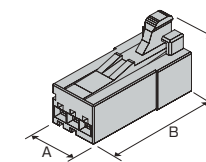

No. of Pos.	Keying	Plating	Color	Part Number	Dimensions		
					A	B	C
3	X	-	Black	1-1318120-3	8.9	20.0	12.0
	Y	-	Black	2-1318120-3			
	Z	-	Black	3-1318120-3			
	X	-	Black	1-1473074-3			

- Tab Housing

Panel type

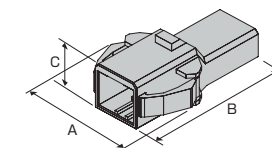

No. of Pos.	Keying	Plating	Color	Part Number	Dimensions		
					A	B	C
3	X	-	Black	1-1318116-3	19.7	30.7	9.5
	Y	-	Black	2-1318116-3			

Free Hanging type

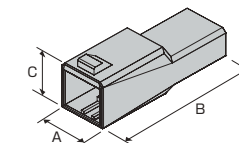

No. of Pos.	Keying	Plating	Color	Part Number	Dimensions		
					A	B	C
3	X	-	Black	1-1318117-3	10.2	30.7	9.5
	Y	-	Black	2-1318117-3			

NOTE: All products are RoHS compliant On selection. You need to confirm LOT and lead time

- PCB Mounting Tab Header Horizontal type

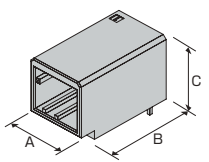

No. of Pos.	Keying	Plating	Color	Part Number	Dimensions		
					A	B	C
3	X	Gold	Black	1376135-1	10.2	17.7	11.0
	Y	Gold	Black	1376135-2			
	Z	Gold	Black	1376135-3			

Vertical type

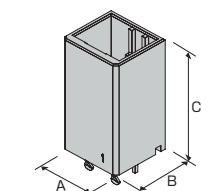

No. of Pos.	Keying	Plating	Color	Part Number	Dimensions		
					A	B	C
3	X	Gold	Black	1318123-1	10.2	9.5	17.8
		Gold	Black	1-1318123-1			
		Gold	Black	1318123-2			

D-2100D 2-Row Standard Type

Part Number Chart

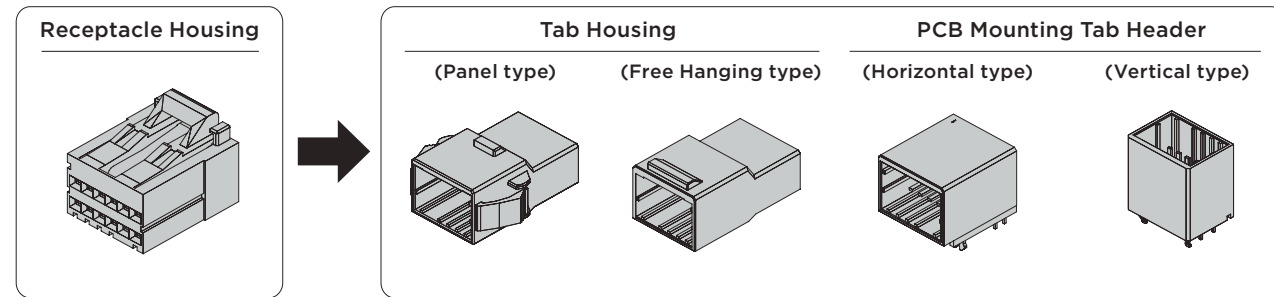

No of Pos.	Color	Keying	Receptacle Housing	Plating	Tab Housing		PCB Mounting Tab Header	
					Panel Type	Free Hanging type	Horizontal type	Vertical type
6	Black	X	1-1318119-3	Gold	1-1318114-3	1-1318115-3	1376136-1	1318124-1
	Black	Y	2-1318119-3	Gold	2-1318114-3	2-1318115-3	1376136-2	1318124-2
8	Black	X	1-1318119-4	Gold	1-1318114-4	1-1318115-4	1376009-1 1-1376009-1*	1318125-1 1-1318125-1*
	Black	Y	2-1318119-4	Gold	2-1318114-4	2-1318115-4	1376009-2	1318125-2 1-1318125-2*
12	Black	X	1-1318118-6	Gold	1-1318114-6	1-1318115-6	1376020-1	1318126-1 1-1318126-1*
	Black	Y	2-1318118-6	Gold	2-1318114-6	-	1376020-2	1318126-2 1-1318126-2*
	Black	Z	3-1318118-6	Gold	-	-	-	1318126-3
16	Black	X	1-1318118-8	Gold	-	-	-	1747994-1
	Black	Y	2-1318118-8	Gold	-	-	-	1747994-2
20	Black	X	1-1318118-9	Gold	1-1318114-9	1-1318115-9	1376137-1	1318127-1
	Black	Y	2-1318118-9	Gold	2-1318114-9	2-1318115-9	1376137-2	1318127-2

* sequential type

Related product information

Application Contact ...P.28
Performance • Specifications ...P.26

Mating Dimension

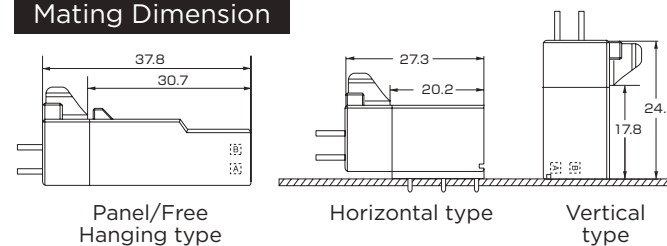

NOTE: All products are RoHS compliant On selection. You need to confirm LOT and lead time

D-2100D 2-Row Standard Type

External dimension

- Receptacle Housing

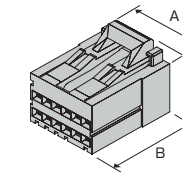

No.of Pos.	Keying	Plating	Color	Part Number	Dimensions		
					A	B	C
6	X	-	Black	1-1318119-3	8.3	20.0	15.8
	Y	-	Black	2-1318119-3			
8	X	-	Black	1-1318119-4	10.8	20.0	15.8
	Y	-	Black	2-1318119-4			
12	X	-	Black	1-1318118-6	15.8	20.0	14.8
	Y	-	Black	2-1318118-6			
	Z	-	Black	3-1318118-6			
16	X	-	Black	1-1318118-8	20.8	20.0	14.8
	Y	-	Black	2-1318118-8			
20	X	-	Black	1-1318118-9	25.8	20.0	14.8
	Y	-	Black	2-1318118-9			

- Tab Housing
Panel type

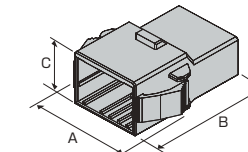

No.of Pos.	Keying	Plating	Color	Part Number	Dimensions		
					A	B	C
6	X	-	Black	1-1318114-3	19.7	30.7	13.2
	Y	-	Black	2-1318114-3			
8	X	-	Black	1-1318114-4	22.2	30.7	13.2
	Y	-	Black	2-1318114-4			
12	X	-	Black	1-1318114-6	27.2	30.7	13.2
	Y	-	Black	2-1318114-6			
20	X	-	Black	1-1318114-9	37.2	30.7	13.2
	Y	-	Black	2-1318114-9			

NOTE: All products are RoHS compliant On selection. You need to confirm LOT and lead time

- Tab Housing
Free Hanging type

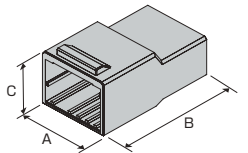

No.of Pos.	Keying	Plating	Color	Part Number	Dimensions		
					A	B	C
6	X	Gold	Black	1-1318115-3	10.2	30.7	10.7
	Y	Gold	Black	2-1318115-3			
8	X	Gold	Black	1-1318115-4	12.7	30.7	10.7
	Y	Gold	Black	2-1318115-4			
12	X	Gold	Black	1-1318115-6	17.7	30.7	10.7
20	X	Gold	Black	1-1318115-9	27.7	30.7	10.7
	Y	Gold	Black	2-1318115-9			

- Board Mount Tab Header
Horizontal type

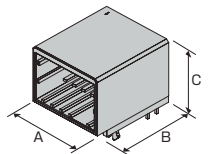

No.of Pos.	Keying	Plating	Color	Part Number	Dimensions		
					A	B	C
6	X	Gold	Black	1376136-1	10.2	20.2	14.7
	Y	Gold	Black	1376136-2			
8	X	Gold	Black	1376009-1 1-1376009-1*	12.7	20.2	14.7
	Y	Gold	Black	1376009-2			
12	X	Gold	Black	1376020-1	17.7	20.2	14.7
	Y	Gold	Black	1376020-2			
20	X	Gold	Black	1376137-1	27.7	20.2	14.7
	Y	Gold	Black	1376137-2			

* sequential type

- Board Mount Tab Header
Vertical type

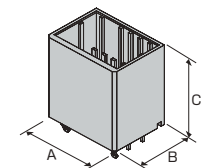

No.of Pos.	Keying	Plating	Color	Part Number	Dimensions		
					A	B	C
6	X	Gold	Black	1318124-1	10.2	13.2	17.8
	Y	Gold	Black	1318124-2			
8	X	Gold	Black	1318125-1 1-1318125-1*	12.7	13.2	17.8
	Y	Gold	Black	1318125-2 1-1318125-2*			
12	X	Gold	Black	1318126-1 1-1318126-1*	17.7	13.2	17.8
	Y	Gold	Black	1318126-2 1-1318126-2*			
	Z	Gold	Black	1318126-3			
16	X	Gold	Black	1747994-1	22.7	13.2	17.8
	Y	Gold	Black	1747994-2			
20	X	Gold	Black	1318127-1	27.7	13.2	17.8
	Y	Gold	Black	1318127-2			

* sequential type

D-2100M 2-Row Standard Multiposition Type (drawer)

Part Number Chart

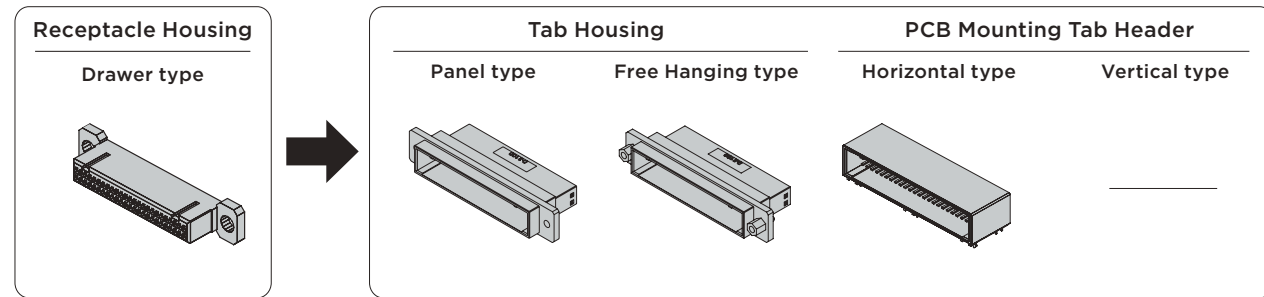

No. of Pos.	Color	Keying	Receptacle Housing		Plating	Tab Housing		PCB Mounting Tab Header	
			Type	Models Number		Panel type	Free Hanging type	Horizontal type	Vertical type
50	Black	-	Drawer	1318577-1	Gold	1318578-1	-	1318579-1	-
	Black	-	Drawer with screw	1376072-2	-	1318578-2 with nut	1376073-2	-	-

Related product information

Application Contact ...P.28
 Performance • Specifications ...P.26
 Accessories ...P.112

Mating Dimension

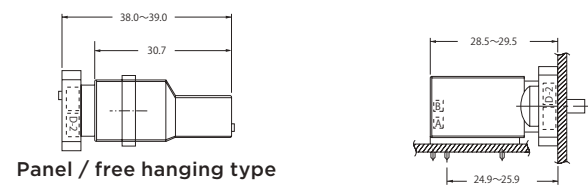

External dimension

- Receptacle Housing
- Receptacle Housing (With Screw)

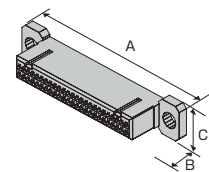

No. of Pos.	Keying	Plating	Color	Part Number	Dimensions		
					A	B	C
50	-	-	Black	1318577-1	88.5	20.0	16.6
50	-	-	Black	1376072-2	88.5	32.0	16.6

- Tab Housing
- Panel type

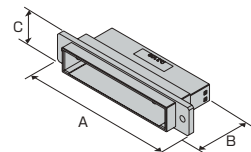

No. of Pos.	Keying	Plating	Color	Part Number	Dimensions		
					A	B	C
50	-	-	Black	1318578-1	86.1	30.7	15.9
	-	-	Black	1318578-2 (with nut)	86.1	30.7	15.9

- Receptacle Assembly (With Screw)
- Free Hanging type

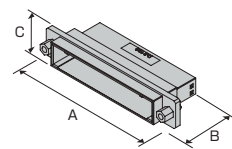

No. of Pos.	Keying	Plating	Color	Part Number	Dimensions		
					A	B	C
50	-	-	Black	1376073-2	86.1	30.7	15.9

- PCB Mounting Tab Header
- Horizontal type

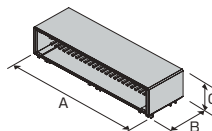

No. of Pos.	Keying	Plating	Color	Part Number	Dimensions		
					A	B	C
50	-	Gold	Black	1318579-1	68.5	21.1	15.4

NOTE: All products are RoHS compliant On selection.
 You need to confirm LOT and lead time

D-2600D 2-Row Combined Type

Part Number Chart

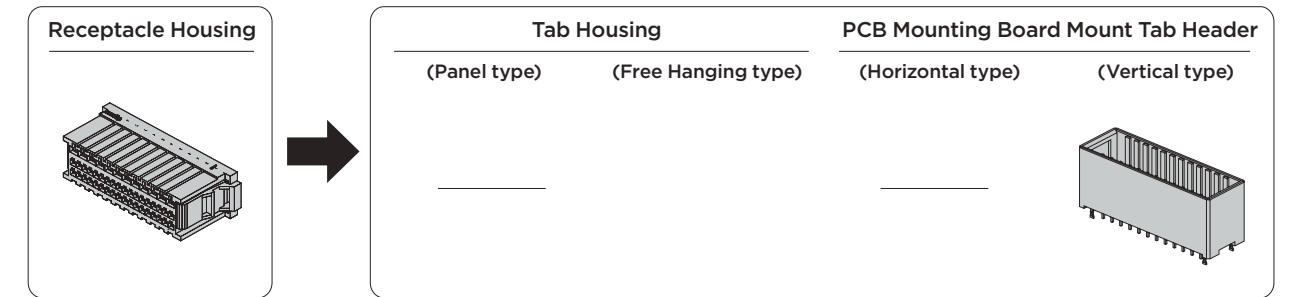

No. of Pos.	Color	Keying	Receptacle Housing	Plating	Tab Housing		PCB Mounting Tab Header	
					Panel type	Free Hanging type	Horizontal type	Vertical type
48	Black	-	1827540-1	Gold	-	-	-	1827538-1

Related product information

Application Contact ...P.28, 38
 Performance • Specifications ...P.26

Mating Dimension

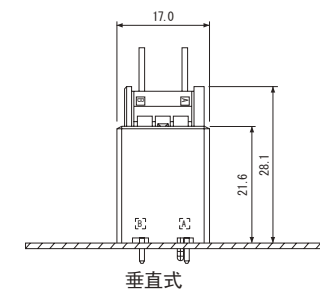

External Dimension

- Receptacle Housing

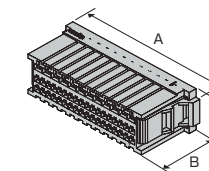

No. of pos.	Keying	Plating	Color	Part number	Dimensions		
					A	B	C
48	-	-	Black	1827540-1	58.7	22.8	15.8

- PCB Mounting Tab Header
- Vertical type

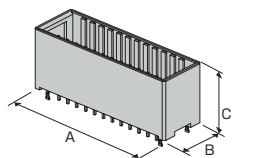

No. of pos.	Keying	Plating	Color	Part number	Dimensions		
					A	B	C
48	-	Gold	Black	1827538-1	55.9	18.0	21.6

D-3000 Series

Series Introduction

The 3000 series is the main Dynamic Series. They are widely used as industrial 'signal' and 'power' connectors.

Pin layout comes in three types: standard 3.81mm pitch high voltage, 5.08mm pitch type and 7.5mm spring clamp pitch type.

The former one is used for signal circuits and the latter two are for high-voltage circuits.

For power source usage, it meets recent demands for small size and high power due to the increasing miniaturisation of the machinery, and the newly developed copper alloy, which can carry a higher current of 15A per pole despite its small size.

This concept is based on the development of the Dynamic Series to cover as wide a range of solutions for as many customers as possible. This concept makes the D-3000 series terminals fit all the housings, and the wide variety of which means that it is not necessary for a customer to look outside of this range for every requirement.

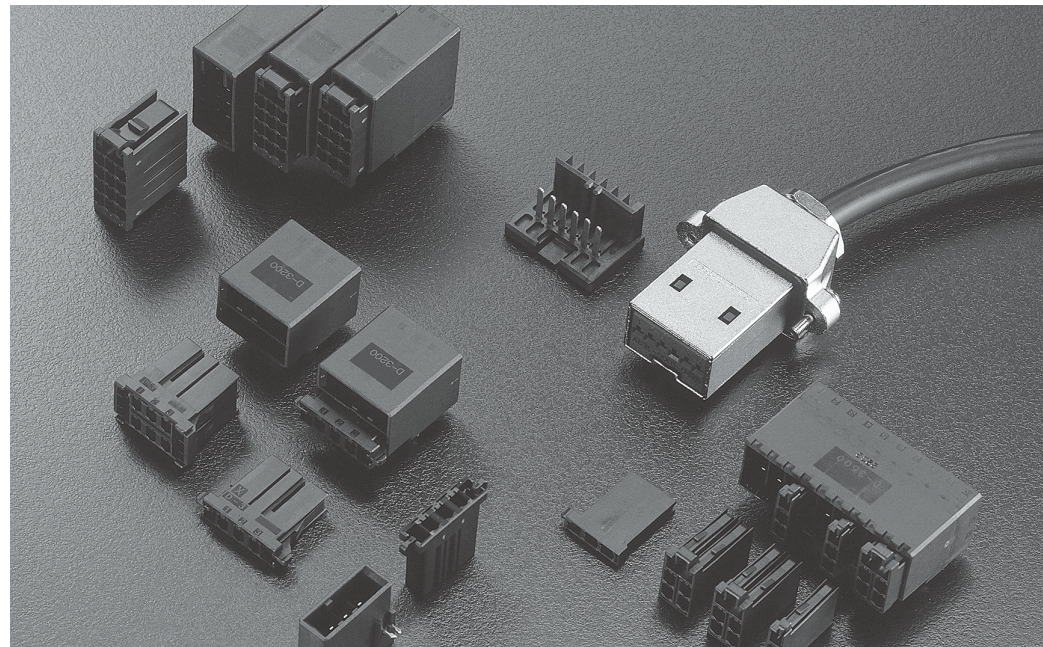

Product Features

- An anti-twist structure developed for the motor industry will lead to the release of our anti-twist receptacle contact box structure. The box contact has 3 points of contact and gives stable reliability in a real-world environment.
- 3 Plating types are available depending on applications, to meet the customer's cost, performance requirements and applications. Under a normal environment with few insertions and withdrawals tin plating can be used, where there is a large number of insertions and withdrawals then gold plating 0.38 μm thick should be used. Further where the environment is deleterious then gold plating at 0.76 μm thick can be selected.
- 2 types of contact pressures are available depending on application: standard Contact pressure for withstanding a large number of insertions and withdrawals or other extreme environments, and high Contact pressure for vibration prone applications.
- High Current: Despite its small size, it conducts up to 15A (at a maximum temperature of 30°C). The latest developed copper alloy adds to the reliability of the 3-point contact structure.
- Audible Latching: When mating, a clear 'lock' sound and vibration will be felt by the assembler, that can prevent working 'blind' mis-mating (or halfmating) problems.
- Keying: The housing provides a keying (slit), hence mis-matings can be prevented by using the X and Y keys separately. At the same time, the keying plug can be used to create new key patterns.

3000 Series Performance Specifications Standards

Performance Specifications

Item	Pitch	150 mil 3.81mm	200mil 5.08mm
Voltage Rating		250V AC/DC	600V AC/DC
Current Rating		1 pole : 15A 3 pole : 12A 6 pole : 9.5A 16 pole : 8A (AWG#16 for use as powersource)	
contact resistance		10mΩ max	
Dielectric Withstanding Voltage		1,500V AC (1 minute)	2,200V AC (1 minute)
Operating Temperature		-55- 105°C	

Pos. Number/Wire size/Rated current

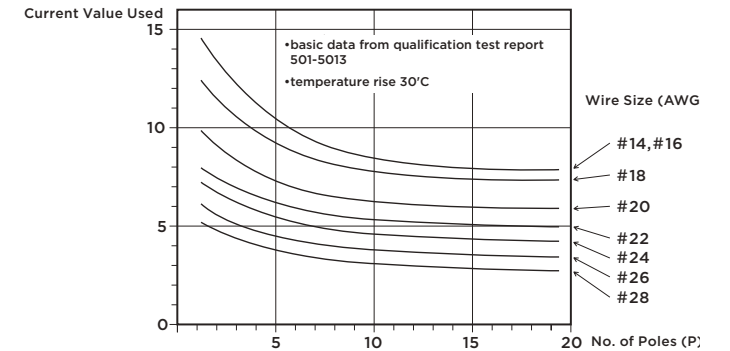

Performance Specifications* Manual

Product standards	108-5349
Test report	501-5013
Mounting application standard	114-5148
Pull tool product number (234168-1) manual	411-5726

Hand tool manual	
Tool product number	Instruction Sheet No
91565-1	408-8547-1
91559-1	
91558-1	
91560-1	
91561-1	
1762954-1	411-78206
1762956-1	411-78207

Please order the manual concurrently.
An E-Catalogue is also available for download from the internet

Safety Specifications

The following safety standards have been approved depending on model number. Please check each model number to see if it has been approved or not. Also, please be aware that these may not match TE.'s own performance specifications.

	D-3100, D - 3400 series (3.81mm pitch)			D-3200, D - 3500 series (5.08mm pitch)																																		
	Voltage Rating	Current Rating	Temperature Rating	Voltage Rating	Current Rating	Temperature Rating																																
108-5349	250V AC/DC	upper table	55 - 105	600V AC/DC	upper table	-55°C - +105°C																																
product standards 108-5349	Based on the requirements of machine in use	Based on the requirements of machine in use	-	Based on the requirements of machine in use	Based on the requirements of machine in use	-																																
UL File No.E28476 Recognized Component	250V AC/DC	8 A MAXIMUM	-	250V AC/DC	8 A MAXIMUM	-																																
CSA Report No. LR7189	250V AC 300V DC		-20°C - +105°C	400V AC 300V DC		-20°C - +105°C																																
TÜV License No. 9151488 R (EN 61984). IP protection IP -00. overvoltage classification (III) Repeated inserts and withdrawals 50 circles	250V AC 300V DC	<table border="1"> <thead> <tr> <th>AWG</th> <th>A</th> </tr> </thead> <tbody> <tr><td>28</td><td>2</td></tr> <tr><td>26</td><td>3</td></tr> <tr><td>24</td><td>3</td></tr> <tr><td>22</td><td>4</td></tr> <tr><td>20</td><td>5</td></tr> <tr><td>18</td><td>6</td></tr> <tr><td>16</td><td>8</td></tr> </tbody> </table>	AWG	A	28	2	26	3	24	3	22	4	20	5	18	6	16	8	-20°C - +105°C	400V AC 300V DC	<table border="1"> <thead> <tr> <th>AWG</th> <th>A</th> </tr> </thead> <tbody> <tr><td>28</td><td>2</td></tr> <tr><td>26</td><td>3</td></tr> <tr><td>24</td><td>3</td></tr> <tr><td>22</td><td>4</td></tr> <tr><td>20</td><td>5</td></tr> <tr><td>18</td><td>6</td></tr> <tr><td>16</td><td>8</td></tr> </tbody> </table>	AWG	A	28	2	26	3	24	3	22	4	20	5	18	6	16	8	-20°C - +105°C
AWG	A																																					
28	2																																					
26	3																																					
24	3																																					
22	4																																					
20	5																																					
18	6																																					
16	8																																					
AWG	A																																					
28	2																																					
26	3																																					
24	3																																					
22	4																																					
20	5																																					
18	6																																					
16	8																																					
	-	Same as above	Same as above	250V AC 300V DC	Same as above	Same as above																																

Material & Finish

Category	Material	Completion
Receptacle contact Tab contact	copper alloy	bright tin plating or nickel undercoat gold plating
PCB side tab post	copper alloy	tin plating or nickel undercoat gold plating
Housing	UL94V-0 glass-reinforced thermoplastic PBT, PPS (SMT type), or liquid crystal polymer (motor connector), Black	

D-3000 Series Applications List

Applicable to both signal circuit and power supply circuit carrying a maximum current of 15A per pole, a full lineup is available from Wire-to-Wire panel type and free hanging type, to Wire-to-Board horizontal and vertical type.

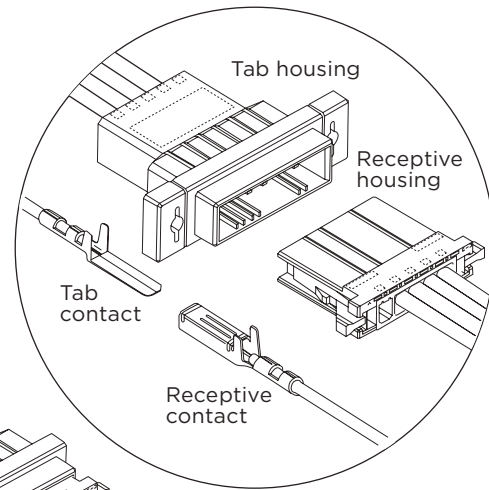

D-3100S
Standard 1-row type

D-3100M
Standard module plug

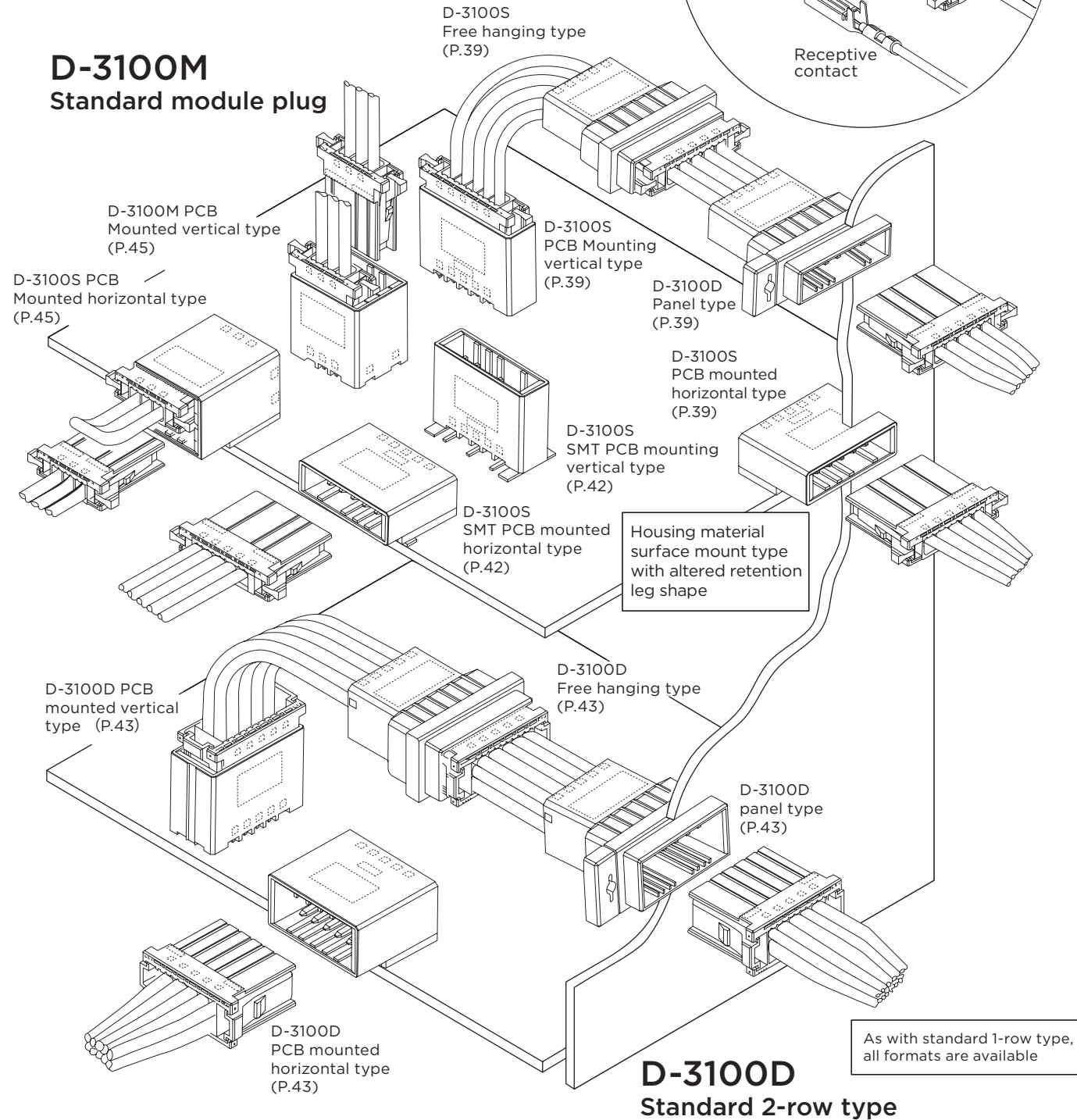

D-3000 Series

D-3000 Series Applications List

D-3200M
High voltage modular type

Suitable for use with high voltage circuits

D-3200S
High voltage 1-row type

Can be used as rack and panel

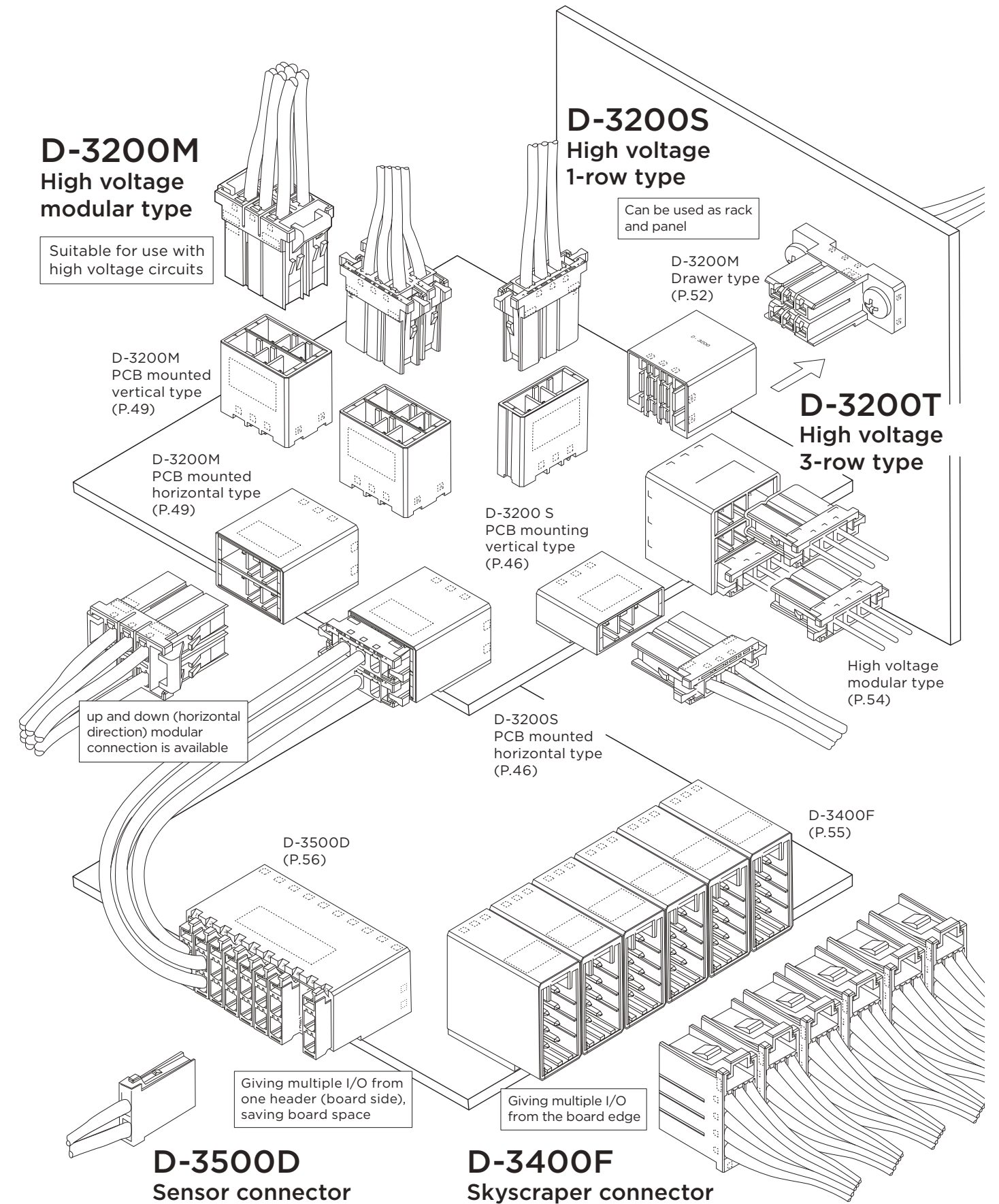

D-3000 Series

D-3000 Series D-3 Contact and Applicable Tools

- Crimped types

Receptacle Contact (used in Receptacle Housing)

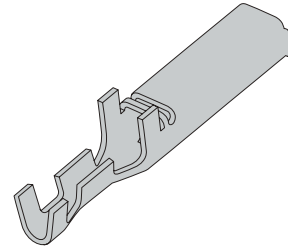

Tab Contact (used in Tab Housing)

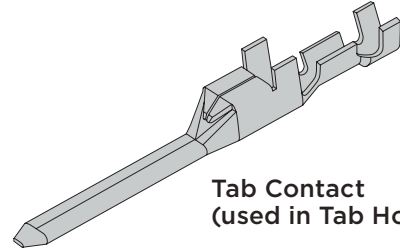

Applicable Wiring Range		Wire Insulation outer diameter mm ※1	Wire Range Mark	Contact Part Number					Applicable Tool Product Number	
AWG	mm ²			Receptacle Contact		Tab Contact		Hand Tool CCII Hand Tool PEW12 Hand Tool* PEW12 dice only	Mini Applicator	
		Strip Form	Loose Piece	Strip form	Loose Piece					
28 26	0.08 0.12	0.8-1.2	S	Standard Contact pressure (gold plating only)	175194-□	175216-□	175284-□	175287-□	91565-1	2088631-2
24	0.20	1.0-1.4		High Contact pressure	1-175194-□	1-175216-□	175287-□			
24 22 20	0.20 0.30 0.50	1.2-1.6 1.7-2.6	M	Standard Contact pressure (gold plating only)	175195-□	175217-□	175285-□	175288-□	91559-1 1762954-1* 1762955-1	2151080-1
16	1.25	2.2-2.8		High Contact pressure	1-175195-□	1-175217-□	175288-□			
20 18	0.50 0.85	1.8-2.8	L	Standard Contact pressure (gold plating only)	175196-□	175218-□	175286-□	175289-□	91558-1 1762956-1* 1762957-1	2151018-1
16	1.25	2.2-2.8		High Contact pressure	1-175196-□	1-175218-□	175289-□			
16 14	1.25 2.20	2.2-2.8	2L	Standard Contact pressure (gold plating only)	917484-□	917511-□	917485-□	917512-□	91560-1	1426353-2
14	2.20	2.2-2.8		High Contact pressure	1-917484-□	1-917511-□	917512-□			
16 14	1.25 2.20	3.1-3.3 3.3-3.8	3L	Standard Contact pressure (gold plating only)	353715-□	353717-□	353716-□	353718-□	91561-1	2151073-1
14	2.20	3.3-3.8		High Contact pressure	1-353715-□	1-353717-□	353718-□			

Reference: plating code

- 2:0.38 μm thickness gold plating
- 3:0.76 μm thickness gold plating
- 5: tin plating (high Contact voltage type only)

Please contact our sales department or authorized distributor for more information. For mini applicator, please contact our sales department

The strip form contact is for use with mini applicator (bench machine) while the loose piece contact is for use with hand tools.

※ 1 insulated covering diameter is for loose connectors For connected type please refer to 114-5148 PEW12 is a die-exchangeable hand tool. * with die, product number of the handle only is 9-1478240-0

The receptacle contact can be used in all receptacle housings, while the tab contact can be used in all tabs housings Details of the applicable tool are available from P. 107

NOTE: all products are RoHS compliant On selection.You need to confirm LOT and lead time

D-3100S 1-Row Standard Types

Part Number Chart

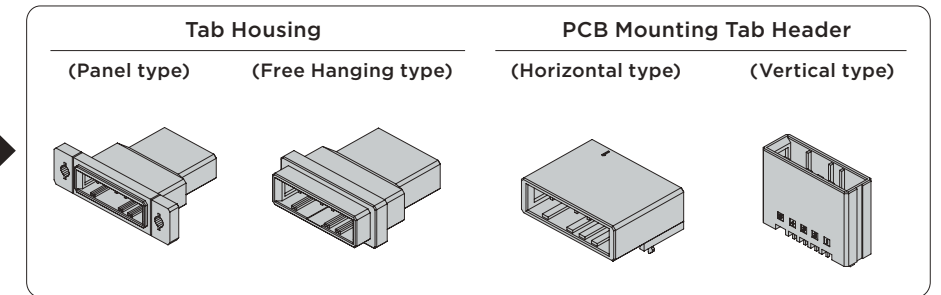
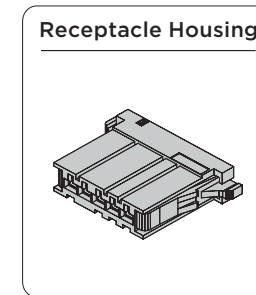

No.of Pos.	Color	Keying	Receptacle Housing	Plating	Tab Housing			PCB Mounting Tab Header		
					Panel	Free Hanging type	L bracket	Horizontal	Vertical type	
3	Black	X	1-178288-3	Gold	1-178802-3	1-177648-3	S	1-178293-2	1-178313-2	
				Gold				1-178293-3	1-178313-3	
				Tin				1-178293-5	1-178313-5	
3	Black	X	-	Tin	-	-	S	-	6-178313-5	
				Gold	2-178802-3	2-177648-3	S	2-178293-2	2-178313-2	
								2-178293-3	2-178313-3	
4	Black	Y	2-178288-4	Tin	-	-	-	2-178293-5	2-178313-5	
				Gold	1-178288-4	-	-	-	1-178294-2	1-178314-2
									1-178294-3	1-178314-3
4	Black	X	1-178288-4	Gold	-	-	-	1-178294-4	1-178314-4	
				Gold	2-178288-4	-	-	-	2-178294-2	2-178314-2
				Tin	-	-	-	2-178294-3	2-178314-3	
5	Black	X	1-178288-5	Gold	1-178802-5	1-177648-5	L	1-178295-2	1-178315-2	
				Gold				1-178295-3	1-178315-3	
				Tin				1-178295-5	1-178315-5	
6	Black	X	1-178288-6	Gold	-	-	-	1-178296-2	1-178316-2	
				Gold	-	-	-	1-178296-3	1-178316-3	
				Tin	-	-	-	1-178296-5	1-178316-5	
6	Black	Y	2-178288-6	Gold	-	-	-	2-178296-2	2-178316-2	
				Gold	-	-	-	-	2-178316-3	
				Tin	-	-	-	-	2-178316-5	
8	Black	X	1-178288-7	Gold	1-178802-7	1-177648-7	L	1-178297-2	1-178317-2	
				Gold				1-178297-3	1-178317-3	
				Tin				1-178297-5	1-178317-5	
10	Black	X	1-178288-8	Gold	1-178802-8	1-177648-8	L	1-178298-2	1-178318-2	
				Gold				1-178298-3	1-178318-3	
				Tin				1-178298-5	1-178318-5	
10	Black	Y	2-178288-8	Gold	2-178802-8	2-177648-8	L	2-178298-3	2-178318-2	
				Gold				2-178298-3	2-178318-2	

Related product information

- Application Contact ...P.38
- Performance • Specifications ...P.35
- Accessories ...P.110, 112

Mating Dimension

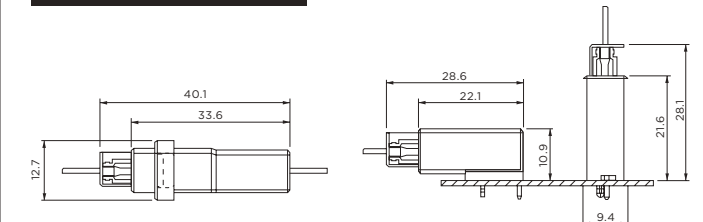

Panel/Free-hanging

Horizontal Vertical type

NOTE: All products are RoHS compliant On selection. You need to confirm LOT and lead time

D-3100S 1-Row Standard Types

External Dimension

- Receptacle Housing

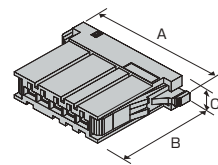

No. of Pos.	Keying	Plating	Color	Part Number	Dimensions		
					A	B	C
3	X	-	Black	1-178288-3	26.8	22.8	7.2
	Y	-	Black	2-178288-3			
4	X	-	Black	1-178288-4	30.6	22.8	7.2
	Y	-	Black	2-178288-4			
5	X	-	Black	1-178288-5	34.4	22.8	7.2
6	X	-	Black	1-178288-6	38.2	22.8	7.2
	Y	-	Black	2-178288-6			
8	X	-	Black	1-178288-7	45.8	22.8	7.2
10	X	-	Black	1-178288-8	53.4	22.8	7.2
	Y	-	Black	2-178288-8			

- Tab Housing
Panel type

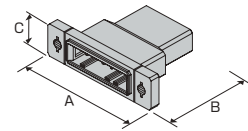

No. of Pos.	Keying	Plating	Color	Part Number	Dimensions		
					A	B	C
3	X	-	Black	1-178802-3	40.0	33.6	12.7
	Y	-	Black	2-178802-3			
5	X	-	Black	1-178802-5	47.0	33.6	12.7
8	X	-	Black	1-178802-7	59.0	33.6	12.7
10	X	-	Black	1-178802-8	67.0	33.6	12.7
	Y	-	Black	2-178802-8			

- Free Hanging type

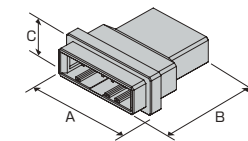

No. of Pos.	Keying	Plating	Color	Part Number	Dimensions		
					A	B	C
3	X	-	Black	1-177648-3	25.6	33.6	12.7
	Y	-	Black	2-177648-3			
5	X	-	Black	1-177648-5	33.2	33.6	12.7
8	X	-	Black	1-177648-7	44.6	33.6	12.7
10	X	-	Black	1-177648-8	52.2	33.6	12.7
	Y	-	Black	2-177648-8			

Applications

Example of elevator applications

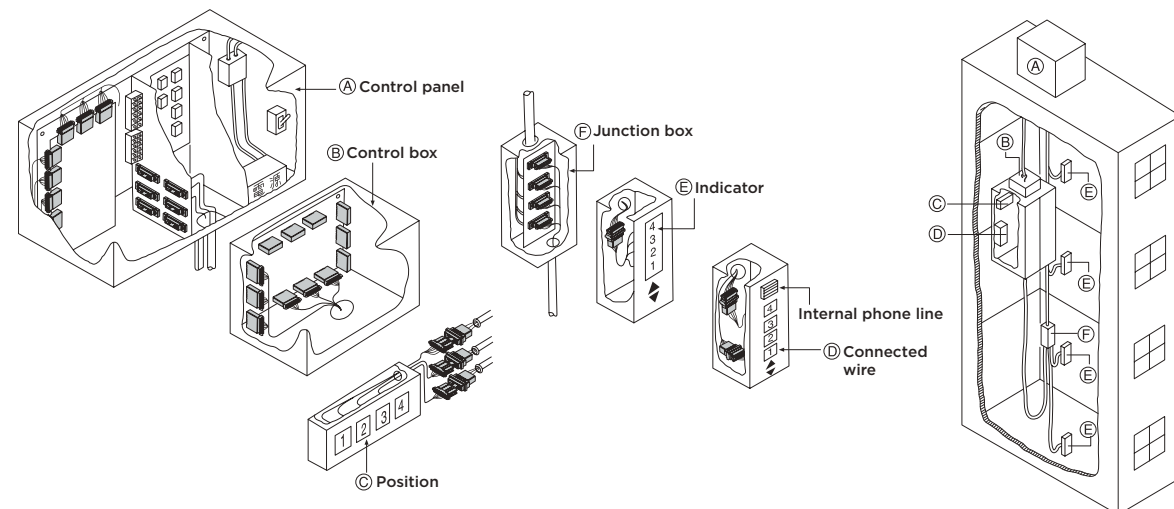

NOTE: All products are RoHS compliant On selection. You need to confirm LOT and lead time

D-3100S 1-Row Standard Types

- PCB Mounting Tab Header
Horizontal type

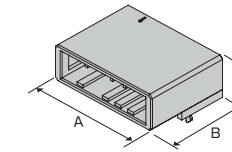

No. of Pos.	Keying	Plating	Color	Part Number	Dimensions		
					A	B	C
3	X	Gold	Black	1-178293-2	21.6	22.1	10.9
		Gold	Black	1-178293-3			
		Tin	Black	1-178293-5			
	Y	Gold	Black	2-178293-2			
		Gold	Black	2-178293-3			
		Tin	Black	2-178293-5			
4	X	Gold	Black	1-178294-2	25.4	22.1	10.9
		Gold	Black	1-178294-3			
		Tin	Black	1-178294-5			
4	Y	Gold	Black	2-178294-2	25.4	22.1	10.9
		Gold	Black	2-178294-3			
		Tin	Black	1-178294-5			
5	X	Gold	Black	1-178295-2	29.2	22.1	10.9
		Tin	Black	1-178295-5			
6	X	Gold	Black	1-178296-2	33.1	22.1	10.9
		Gold	Black	1-178296-3			
		Tin	Black	1-178296-5			
6	Y	Gold	Black	2-178296-2	33.1	22.1	10.9
		Tin	Black	1-178296-5			
8	X	Gold	Black	1-178297-2	40.7	22.1	10.9
		Gold	Black	1-178297-3			
		Tin	Black	1-178297-5			
10	X	Gold	Black	1-178298-2	48.3	22.1	10.9
		Gold	Black	1-178298-3			
	Tin	Black	1-178298-5				
	Y	Gold	Black	2-178298-3			

- PCB Mounting Tab Header
Vertical type

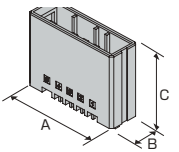

No. of Pos.	Keying	Plating	Color	Part Number	Dimensions		
					A	B	C
3	X	Gold	Black	1-178313-2	21.6	9.4	21.6
		Gold	Black	1-178313-3			
		Tin	Black	1-178313-5			
	Y	Tin	natural colour	6-178313-5			
		Gold	Black	2-178313-2			
		Gold	Black	2-178313-3			
4	X	Gold	Black	1-178314-2	25.4	9.4	21.6
		Gold	Black	1-178314-3			
		Tin	Black	1-178314-5			
	Y	Gold	Black	2-178314-2			
		Gold	Black	2-178314-3			
		Tin	Black	2-178314-5			
5	X	Gold	Black	1-178315-2	29.2	9.4	21.6
		Gold	Black	1-178315-3			
		Tin	Black	1-178315-5			
6	X	Gold	Black	1-178316-2	33.1	9.4	21.6
		Gold	Black	1-178316-3			
		Tin	Black	1-178316-5			
	Y	Gold	Black	2-178316-2			
		Gold	Black	2-178316-3			
		Tin	Black	2-178316-5			
8	X	Gold	Black	1-178317-2	40.7	9.4	21.6
		Gold	Black	1-178317-3			
		Tin	Black	1-178317-5			
10	X	Gold	Black	1-178318-2	48.3	9.4	21.6
		Gold	Black	1-178318-3			
	Tin	Black	1-178318-5				
	Y	Gold	Black	2-178318-2			

NOTE: All products are RoHS compliant On selection. You need to confirm LOT and lead time

D-3100S SMT Types

Part Number Chart

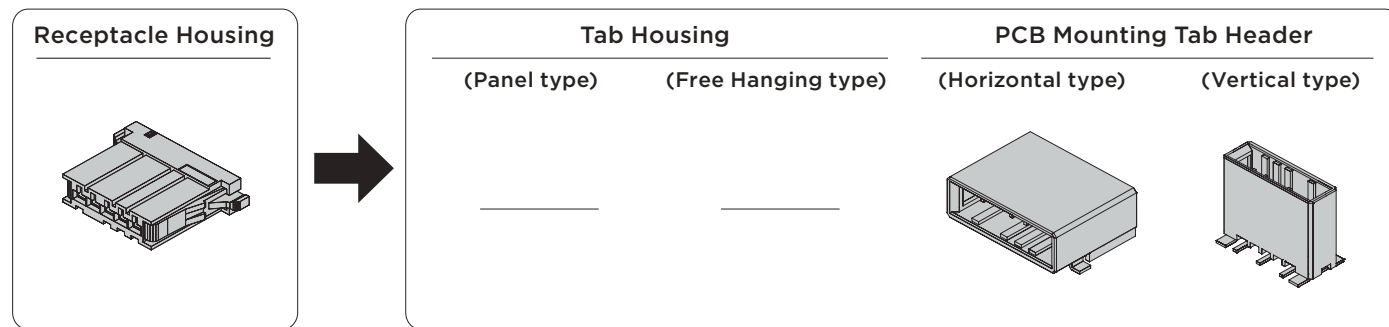

No of Pos.	Color	Key	Receptacle Housing	Plating	Tab Housing		PCB Mounting Tab Header	
					Tab Housing	Free Hanging type	Horizontal type	Vertical type
5	Black	X	1-178288-5	Gold	-	-	1-177662-2	1-177665-2
8	Black	X	1-178288-7	Gold	-	-	1-179188-2	-
					-	-	1-179188-3	

Mating Dimension

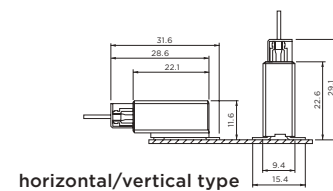

External Dimension

- Receptacle Housing

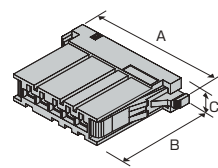

No of Pos.	Keying	Plating	Color	Part number	Dimensions		
					A	B	C
5	X	-	Black	1-178288-5	34.4	22.8	7.2
8	X	-	Black	1-178288-7	45.8	22.8	7.2

- PCB Mounting Tab Header
Horizontal type

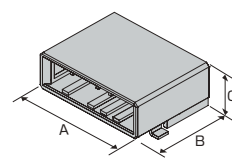

No. of pos.	Keying	Plating	Color	Part number	Dimensions		
					A	B	C
5	X	Gold	Black	1-177662-2	29.2	22.1	11.6
		Gold	Black	1-179188-2	40.7	22.1	11.6
Gold	Black	1-179188-3					

- Vertical type

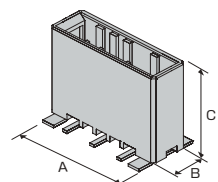

No. of pos.	Keying	Plating	Color	Part number	Dimensions		
					A	B	C
5	X	Gold	Black	1-177665-2	29.2	9.4	22.6

NOTE: All products are RoHS compliant On selection. You need to confirm LOT and lead time

D-3100D 2-Row Standard Type

Part Number Chart

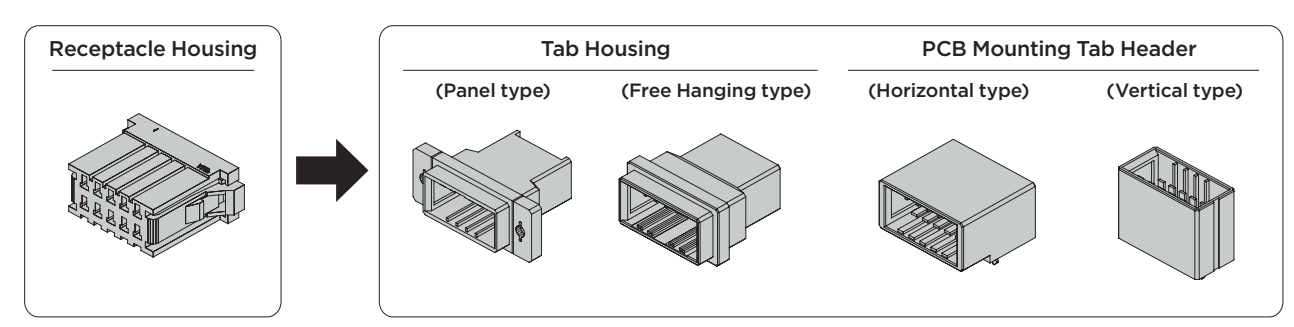

No of Pos.	Color	Key	Receptacle Housing	Plating	Tab Housing			PCB Mounting Tab Header	
					Panel Type	Free Hanging Type	L Bracket	Horizontal	Vertical type
6	Black	X	178289-3	Gold	178803-3	178964-3	S	178303-2	178323-2
				Gold				178303-3	178323-3
				Tin				178303-5	178323-5
8	Black	X	178289-4	Gold	-	178964-4	S	1717412-2	1903601-2
				Tin				-	1903601-5
				Gold				178305-2	178325-2
10	Black	X	178289-5	Gold	178803-5	178964-5	L	178305-3	178325-3
				Gold				178305-5	178325-5
				Tin				178306-2	178326-2
12	Black	X	178289-6	Gold	178803-6	178964-6	L	178306-3	178326-3
				Tin				178306-5	178326-5
				Gold				178307-2	178327-2
16	Black	X	178289-7	Gold	178803-7	178964-7	L	178307-3	178327-3
				Tin				178307-5	178327-5
				Gold				178308-2	178328-2
20	Black	X	178289-8	Gold	178803-8	178964-8	L	178308-3	178328-3
				Gold				178308-5	178328-5
				Tin					

Related product information

Application Contact ...P.38
Performance • Specifications ...P.35
Accessories ...P.110, 112

Mating Dimension

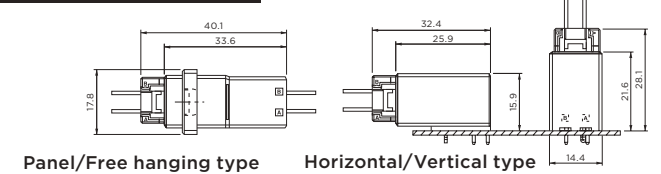

Application

Programmable Controller Application Example

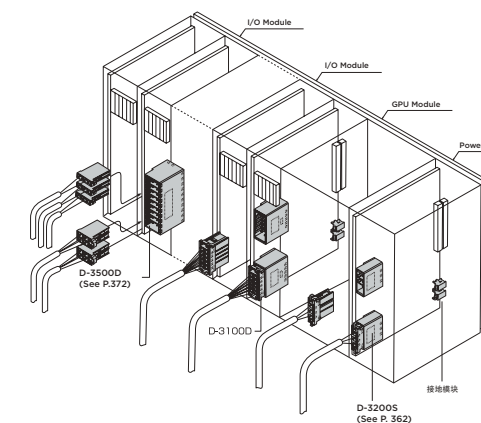

NOTE: All products are RoHS compliant On selection. You need to confirm LOT and lead time

D-3100D 2-Row Standard Type

External Dimension

- Receptacle Housing

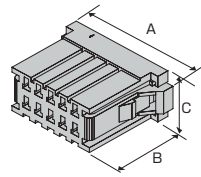

No. of Pos.	Keying	Plating	Color	Part Number	Dimensions		
					A	B	C
6	X	-	Black	178289-3	24.4	22.8	12.5
8	X	-	Black	178289-4	28.2	22.8	12.5
10	X	-	Black	178289-5	32.0	22.8	12.5
12	X	-	Black	178289-6	35.8	22.8	12.5
16	X	-	Black	178289-7	42.7	22.8	12.5
20	X	-	Black	178289-8	51.0	22.8	12.5

- PCB Mounting Tab Header

Horizontal type

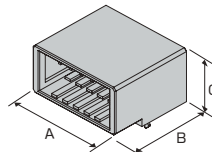

No. of Pos.	Keying	Plating	Color	Part Number	Dimensions		
					A	B	C
6	X	Gold	Black	178303-2	21.6	25.9	15.9
	X	Tin	Black	178303-5			
8	X	Gold	Black	1717412-2	25.4	25.9	15.9
	X	Gold	Black	1717412-3			
10	X	Gold	Black	178305-2	29.2	25.9	15.9
	X	Tin	Black	178305-5			
12	X	Gold	Black	178306-2	33.1	25.9	15.9
	X	Tin	Black	178306-5			
16	X	Gold	Black	178307-2	40.7	25.9	15.9
	X	Tin	Black	178307-5			
20	X	Gold	Black	178308-2	48.3	25.9	15.9
	X	Tin	Black	178308-5			

- PCB Mounting Tab Header

Vertical type

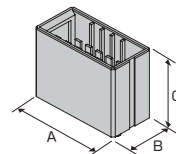

No. of Pos.	Keying	Plating	Color	Part Number	Dimensions		
					A	B	C
6	X	Gold	Black	178323-2	21.6	14.4	21.6
	X	Gold	Black	178323-3			
	X	Tin	Black	178323-5			
8	X	Gold	Black	1903601-2	25.4	14.4	21.6
	X	Tin	Black	1903601-5			
10	X	Gold	Black	178325-2	29.2	14.4	21.6
	X	Tin	Black	178325-5			
12	X	Gold	Black	178326-2	33.1	14.4	21.6
	X	Tin	Black	178326-5			
16	X	Gold	Black	178327-2	40.7	14.4	21.6
	X	Tin	Black	178327-5			
20	X	Gold	Black	178328-2	48.3	14.4	21.6
	X	Tin	Black	178328-5			

NOTE: All products are RoHS compliant On selection. You need to confirm LOT and lead time

D-3100M 2 Row Standard Modular Type

Part Number Chart

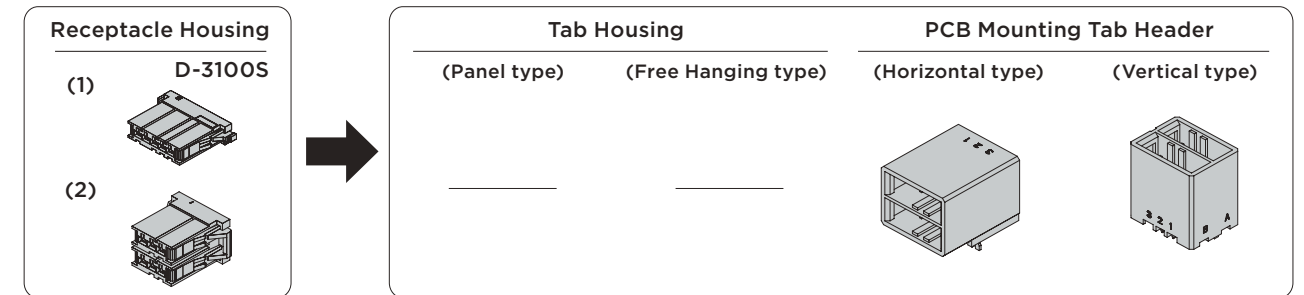

No. of Pos.	Color	Key	Receptacle Housing		Plating	Tab Housing		PCB Mounting Tab Header	
			1 row 3 pos. 1	2 rows 6 pos.		Panel Type	Free Hanging Type	Horizontal type	Vertical type
			6	Black		XX	1-178288-3	1-178127-6	Gold
1-178288-3	1-178127-6	Gold			-		-	1-178137-3	1-178141-3
Black	YY	2-178288-3		2-178127-6	Gold	-	-	1-178137-5	1-178141-5
		2-178288-3		2-178127-6	Gold	-	-	2-178137-2	-
Black	XY	1-178288-3		3-178127-6	Gold	-	-	2-178137-5	-
		2-178288-3		3-178127-6	Gold	-	-	3-178137-2	3-178141-2
				Tin	-	-	3-178137-3	3-178141-3	

Related product information

Application Contact ...P.38
Performance • Specifications ...P.35

Mating Dimension

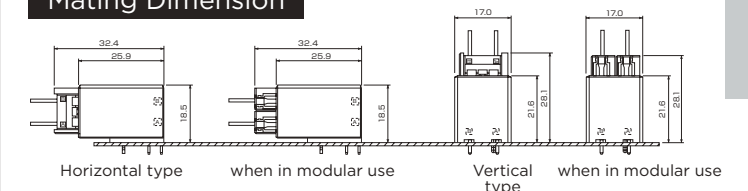

External Dimension

- Receptacle Housing

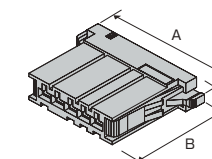

No. of Pos.	Keying	Plating	Color	Part Number	Dimensions		
					A	B	C
3	X	-	Black	1-178288-3	26.8	22.8	7.2
	Y	-	Black	2-178288-3			

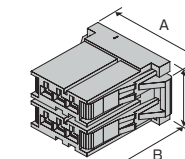

No. of Pos.	Keying	Plating	Color	Part Number	Dimensions		
					A	B	C
6	XX	-	Black	1-178127-6	24.8	22.8	14.8
	YY	-	Black	2-178127-6			
	XY	-	Black	3-178127-6			

NOTE: All products are RoHS compliant On selection. You need to confirm LOT and lead time

- PCB Mounting Tab Header

Horizontal type

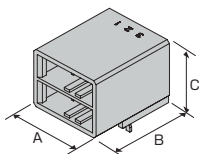

No. of Pos.	Keying	Plating	Color	Part Number	Dimensions		
					A	B	C
6	XX	Gold	Black	1-178137-2	21.6	25.9	18.5
		Gold	Black	1-178137-3			
		Tin	Black	1-178137-5			
	YY	Gold	Black	2-178137-2			
		Tin	Black	2-178137-5			
		Gold	Black	3-178137-2			
XY	Gold	Black	3-178137-3				
	Tin	Black	3-178137-5				

- PCB Mounting Tab Header

Vertical type

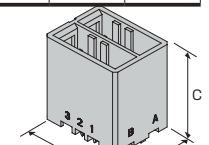

No. of Pos.	Keying	Plating	Color	Part Number	Dimensions		
					A	B	C
6	XX	Gold	Black	1-178141-2	21.6	17.0	21.6
		Gold	Black	1-178141-3			
		Tin	Black	1-178141-5			
	XY	Gold	Black	3-178141-2			
		Gold	Black	3-178141-3			

NOTE: All products are RoHS compliant On selection. You need to confirm LOT and lead time

D-3200S 1 Row High Voltage Type

Part Number Chart

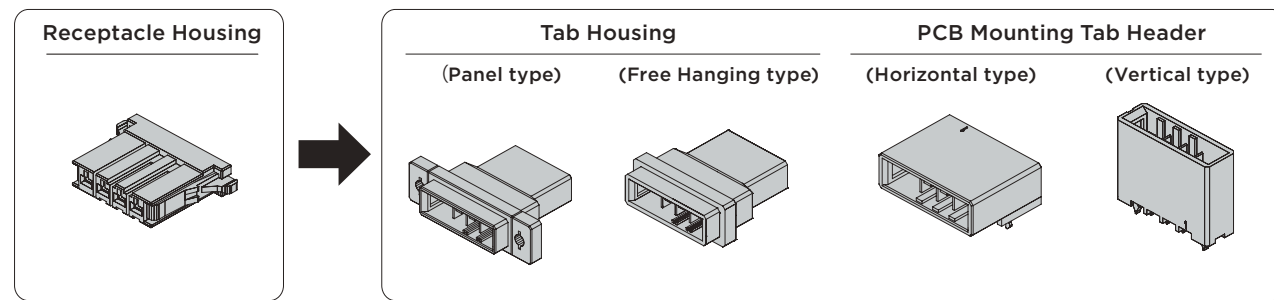

No. of Pos.	Color	Key	Receptacle Housing	Plating	Tab Housing			PCB Mounting Tab Header	
					Panel Type	Free Hanging Type	L Bracket bracket	Horizontal	Vertical type
2	Black	X	1-178128-2	Gold	1-179553-2	1-179552-2	S	1-179276-2	1-917337-2
				Gold				1-179276-3	1-917337-3
				Tin				1-179276-5	1-917337-5
	Black	Y	2-178128-2	Gold	2-179553-2	2-179552-2	S	2-179276-2	2-917337-2
				Gold				2-179276-3	2-917337-3
				Tin				-	2-917337-5
3	Black	X	1-178128-3	Gold	1-179553-3	1-179552-3	S	1-178138-2	1-178136-2
				Gold				1-178138-3	1-178136-3
				Tin				1-178138-5	1-178136-5
	Black	Y	2-178128-3	Gold	2-179553-3	2-179552-3	S	2-178138-2	2-178136-2
				Gold				2-178138-3	2-178136-3
				Tin				2-178138-5	2-178136-5
Black	Z	3-178128-3	Tin	-	-	-	-	3-178136-5	
4	Black	X	1-178128-4	Gold	1-179553-4	1-179552-4	S	1-179277-2	1-917338-2
				Gold				1-179277-3	1-917338-3
				Tin				1-179277-5	1-917338-5
	Black	Y	2-178128-4	Gold	2-179553-4	2-179552-4	S	2-179277-2	2-917338-2
				Gold				2-179277-3	2-917338-3
				Tin				2-179277-5	2-917338-5
5	Black	X	1-178128-5	Gold	-	-	-	1-316130-2	1-316132-2
				Gold				1-316130-3	1-316132-3
				Tin				1-316130-5	1-316132-5
	Black	Y	2-178128-5	Gold	-	-	-	-	2-316132-2
				Gold				2-316130-3	2-316132-3
				Gold				1-316131-2	1-316133-2
Black	X	1-178128-6	Gold	-	-	-	1-316131-3	1-316133-3	
			Gold				1-316131-5	1-316133-5	
			Tin				1-316131-5	1-316133-5	
Black	Y	2-178128-6	Gold	-	-	-	2-316131-2	2-316133-2	
			Gold				-	2-316133-3	
			Gold				-	2-316133-3	

Related product information

Application Contact ...P.38
 Performance • Specifications ...P.35
 Accessories ...P.110, 112

NOTE: All products are RoHS compliant On selection.
 You need to confirm LOT and lead time

D-3200S 1 Row High Voltage Types

Mating Dimension

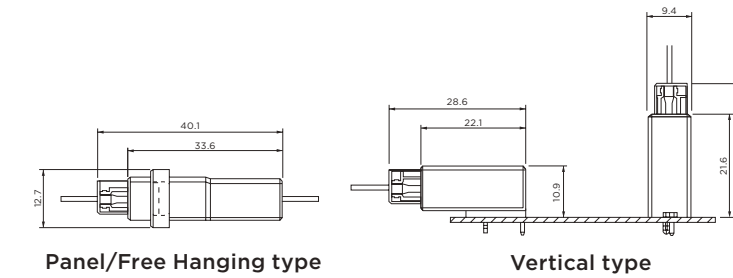

External Dimension

- Receptacle Housing

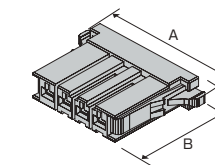

No. of Pos.	Keying	Plating	Color	Part Number	Dimensions		
					A	B	C
2	X	-	Black	1-178128-2	24.6	22.8	7.2
	Y	-	Black	2-178128-2			
3	X	-	Black	1-178128-3	29.7	22.8	7.2
	Y	-	Black	2-178128-3			
	Z	-	Black	3-178128-3			
4	X	-	Black	1-178128-4	34.8	22.8	7.2
	Y	-	Black	2-178128-4			
5	X	-	Black	1-178128-5	39.9	22.8	7.2
	Y	-	Black	2-178128-5			
6	X	-	Black	1-178128-6	45.0	22.8	7.2
	Y	-	Black	2-178128-6			

- Tab Housing
Panel type

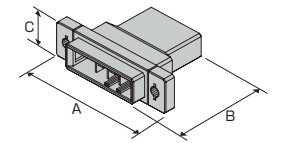

No. of Pos.	Keying	Plating	Color	Part Number	Dimensions		
					A	B	C
2	X	-	Black	1-179553-2	36.8	33.6	12.7
	Y	-	Black	2-179553-2			
3	X	-	Black	1-179553-3	41.9	33.6	12.7
	Y	-	Black	2-179553-3			
4	X	-	Black	1-179553-4	47.0	33.6	12.7
	Y	-	Black	2-179553-4			

- Free Hanging type

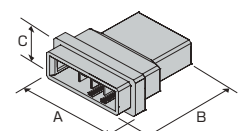

No. of Pos.	Keying	Plating	Color	Part Number	Dimensions		
					A	B	C
2	X	-	Black	1-179552-2	23.0	33.6	12.7
	Y	-	Black	2-179552-2			
3	X	-	Black	1-179552-3	28.1	33.6	12.7
	Y	-	Black	2-179552-3			
4	X	-	Black	1-179552-4	33.2	33.6	12.7
	Y	-	Black	2-179552-4			

NOTE: All products are RoHS compliant On selection.
 You need to confirm LOT and lead time

D-3200S 1 Row High Voltage Types

- PCB Mounting Tab Header
Horizontal type

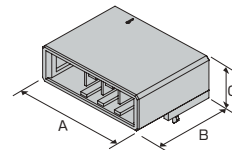

No. of Pos.	Keying	Plating	Color	Part Number	Dimensions		
					A	B	C
2	X	Gold	Black	1-179276-2	19.1	22.1	10.9
		Gold	Black	1-179276-3			
		Tin	Black	1-179276-5			
2	Y	Gold	Black	2-179276-2	19.1	22.1	10.9
		Gold	Black	2-179276-3			
3	X	Gold	Black	1-178138-2	24.2	22.1	10.9
		Gold	Black	1-178138-3			
		Tin	Black	1-178138-5			
	Y	Gold	Black	2-178138-2			
		Gold	Black	2-178138-3			
		Tin	Black	2-178138-5			
4	X	Gold	Black	1-179277-2	29.2	22.1	10.9
		Gold	Black	1-179277-3			
	Y	Gold	Black	2-179277-2			
		Tin	Black	2-179277-5			
5	X	Gold	Black	1-316130-2	34.3	22.1	10.9
		Gold	Black	1-316130-3			
		Tin	Black	1-316130-5			
5	Y	Gold	Black	2-316130-3	34.3	22.1	10.9
		Gold	Black	2-316131-2			
6	X	Gold	Black	1-316131-2	39.4	22.1	10.9
		Gold	Black	1-316131-3			
		Tin	Black	1-316131-5			
6	Y	Gold	Black	2-316131-2	39.4	22.1	10.9
		Gold	Black	2-316131-3			

- PCB Mounting Tab Header
Vertical type

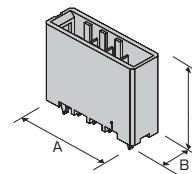

No. of Pos.	Keying	Plating	Color	Part Number	Dimensions		
					A	B	C
2	X	Gold	Black	1-917337-2	19.1	9.4	21.6
		Gold	Black	1-917337-3			
		Tin	Black	1-917337-5			
2	Y	Gold	Black	2-917337-2	19.1	9.4	21.6
		Gold	Black	2-917337-3			
		Tin	Black	2-917337-5			
3	X	Gold	Black	1-178136-2	24.2	9.4	21.6
		Gold	Black	1-178136-3			
		Tin	Black	1-178136-5			
	Y	Gold	Black	2-178136-2			
		Gold	Black	2-178136-3			
		Tin	Black	2-178136-5			
4	X	Gold	Black	1-917338-2	29.2	9.4	21.6
		Gold	Black	1-917338-3			
	Y	Gold	Black	2-917338-2			
		Tin	Black	2-917338-5			
5	X	Gold	Black	1-316132-2	34.3	9.4	21.6
		Gold	Black	1-316132-3			
	Y	Gold	Black	2-316132-2			
		Gold	Black	2-316132-3			
6	X	Gold	Black	1-316133-2	39.4	9.4	21.6
		Gold	Black	1-316133-3			
	Y	Gold	Black	2-316133-2			
		Gold	Black	2-316133-3			

NOTE: All products are RoHS compliant On selection. You need to confirm LOT and lead time

D-3200M 2 Row High Voltage types

Part Number Chart

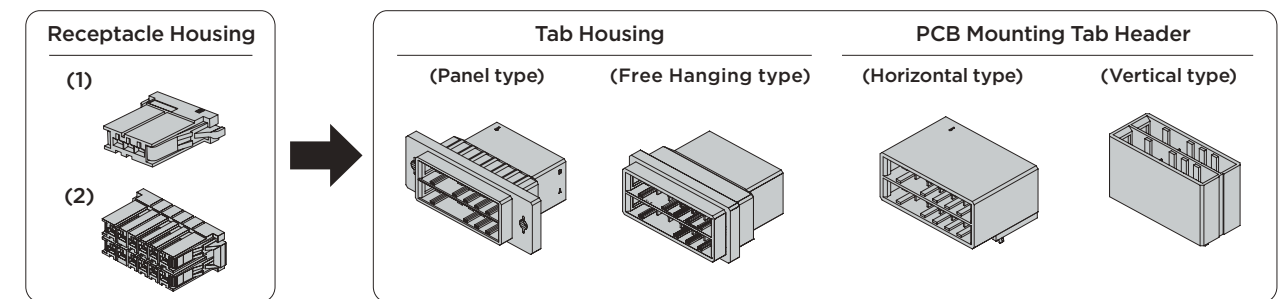

No. of Pos.	Color	Key	Receptacle Housing (2)	Plating	Tab Housing			PCB Mounting Tab Header			
					Panel Type	Free Hanging Type	L Bracket bracket	Horizontal type	Vertical type		
6	-	XX	1-178129-6	Gold	1-179555-3	1-179554-3	S	1-178139-2	1-178140-2		
				Gold			S	1-178139-3	1-178140-3		
				Tin			S	1-178139-5	1-178140-5		
	-	YY	2-178129-6	Gold	2-179555-3	2-179554-3	S	2-178139-2	2-178140-2		
				Gold			S	2-178139-3	2-178140-3		
				Tin			S	2-178139-5	2-178140-5		
	-	XY	3-178129-6	Gold	3-179555-3	3-179554-3	S	3-178139-2	3-178140-2		
				Gold			S	3-178139-3	3-178140-3		
				Tin			S	3-178139-5	3-178140-5		
-	YX	※(1)	Gold	-	-	-	4-178139-2	-			
			Gold	-	-	-	6-178139-5	-			
			Tin	-	-	-	-	-			
10	-	XX	1-917659-5	Gold	-	-	-	1-316080-2	1-917657-2		
				Gold			-	-	-	1-316080-3	1-917657-3
				Tin			-	-	-	1-316080-5	1-917657-5
	-	YY	2-917659-5	Gold	-	-	-	2-316080-2	2-917657-2		
				Gold			-	-	-	2-316080-3	2-917657-3
				Tin			-	-	-	2-316080-5	2-917657-5
	-	XY	3-917659-5	Gold	-	-	-	3-316080-2	3-917657-2		
				Gold			-	-	-	3-316080-3	3-917657-3
				Tin			-	-	-	3-316080-5	3-917657-5
12	-	XX	1-917659-6	Gold	1-179555-6	1-179554-6	L	1-316081-2	1-917658-2		
				Gold			L	1-316081-3	1-917658-3		
				Tin			L	1-316081-5	1-917658-5		
	-	YY	2-917659-6	Gold	2-179555-6	-	L	2-316081-2	2-917658-2		
				Gold			L	2-316081-3	2-917658-3		
				Tin			L	2-316081-5	2-917658-5		
	-	XY	3-917659-6	Gold	3-179555-6	3-179554-6	L	3-316081-2	3-917658-2		
				Gold			L	3-316081-3	3-917658-3		
				Tin			L	-	-		
20	-	XX	1-917659-8	-	1-179555-8	-	-	-			

Related product information

Application Contact ...P.38
 Performance • Specifications ...P.35
 Accessories ...P.110, 112
 For (1) D-3200S please see P. 47
 Receptacle housing 1-178128-3
 3-178128-3 used

NOTE: All products are RoHS compliant On selection. You need to confirm LOT and lead time

D-3000 Series

D-3000 Series

D-3200M 2-Row High Voltage Modular Types

Mating Dimension

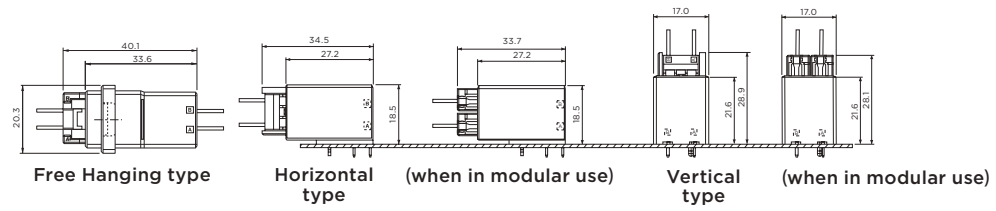

External Dimension

• Receptacle Housing

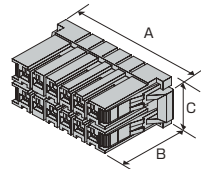

No. of Pos.	Keying	Plating	Color	Part Number	Dimensions		
					A	B	C
6	XX	-	Black	1-178129-6	27.3	22.8	14.8
	YY	-	Black	2-178129-6			
	XY	-	Black	3-178129-6			
10	XX	-	Black	1-917659-5	37.5	22.8	14.8
	YY	-	Black	2-917659-5			
	XY	-	Black	3-917659-5			
12	XX	-	Black	1-917659-6	42.5	22.8	14.8
	YY	-	Black	2-917659-6			
	XY	-	Black	3-917659-6			
20	XX	-	Black	1-917659-8	62.9	22.8	14.8

• Tab Housing
Panel type

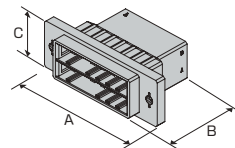

No. of Pos.	Keying	Plating	Color	Part Number	Dimensions		
					A	B	C
6	XX	-	Black	1-179555-3	41.9	33.6	20.3
	YY	-	Black	2-179555-3			
	XY	-	Black	3-179555-3			
12	XX	-	Black	1-179555-6	57.9	33.6	20.3
	YY	-	Black	2-179555-6			
	XY	-	Black	3-179555-6			
20	XX	-	Black	1-179555-8	78.2	33.6	20.3

Free Hanging type

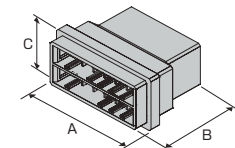

No. of Pos.	Keying	Plating	Color	Part Number	Dimensions		
					A	B	C
6	XX	-	Black	1-179554-3	28.1	33.6	20.3
	YY	-	Black	2-179554-3			
	XY	-	Black	3-179554-3			
12	XX	-	Black	1-179554-6	43.4	33.6	20.3
	XY	-	Black	3-179554-6			

NOTE: All products are RoHS compliant On selection. You need to confirm LOT and lead time

D-3200M 2-Row High Voltage Modular Types

• PCB Mounting Tab Header
Horizontal type

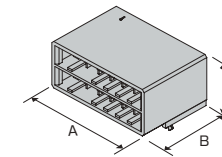

No. of Pos.	Keying	Plating	Color	Part Number	Dimensions		
					A	B	C
6	XX	Gold	Black	1-178139-2	24.2	27.2	18.5
		Gold	Black	1-178139-3			
		Tin	Black	1-178139-5			
	YY	Gold	Black	2-178139-2			
		Gold	Black	2-178139-3			
		Tin	Black	2-178139-5			
	XY	Gold	Black	3-178139-2			
		Gold	Black	3-178139-3			
		Tin	Black	3-178139-5			
YX	Gold	Black	4-178139-2				
	Tin	Black	6-178139-5				
	10	XX	Gold	Black	1-316080-2	34.3	27.2
Gold			Black	1-316080-3			
Tin			Black	1-316080-5			
YY		Gold	Black	2-316080-2			
		Gold	Black	2-316080-3			
		Tin	Black	2-316080-5			
XY		Gold	Black	3-316080-2			
		Gold	Black	3-316080-3			
		Tin	Black	3-316080-5			
12	XX	Gold	Black	1-316081-2	39.4	27.2	18.5
		Gold	Black	1-316081-3			
		Tin	Black	1-316081-5			
	YY	Gold	Black	2-316081-2			
		Gold	Black	2-316081-3			
		Tin	Black	2-316081-5			
	XY	Gold	Black	3-316081-2			
		Gold	Black	3-316081-3			
		Tin	Black	3-316081-5			

• PCB Mounting Tab Header
Vertical type

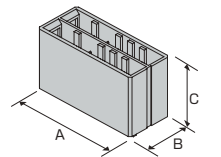

No. of Pos.	Keying	Plating	Color	Part Number	Dimensions		
					A	B	C
6	XX	Gold	Black	1-178140-2	24.2	17.0	21.6
		Gold	Black	1-178140-3			
		Tin	Black	1-178140-5			
	YY	Gold	Black	2-178140-2			
		Gold	Black	2-178140-3			
		Tin	Black	2-178140-5			
	XY	Gold	Black	3-178140-2			
		Gold	Black	3-178140-3			
		Tin	Black	3-178140-5			
10	XX	Gold	Black	1-917657-2	34.3	17.0	21.6
		Gold	Black	1-917657-3			
		Tin	Black	1-917657-5			
	YY	Gold	Black	2-917657-2			
		Gold	Black	2-917657-3			
		Tin	Black	2-917657-5			
	XY	Gold	Black	3-917657-2			
		Gold	Black	3-917657-3			
		Tin	Black	3-917657-5			
12	XX	Gold	Black	1-917658-2	39.4	17.0	21.6
		Gold	Black	1-917658-3			
		Tin	Black	1-917658-5			
	YY	Gold	Black	2-917658-2			
		Gold	Black	2-917658-3			
		Tin	Black	2-917658-5			
	XY	Gold	Black	3-917658-2			
		Gold	Black	3-917658-3			
		Tin	Black	3-917658-5			

NOTE: All products are RoHS compliant On selection. You need to confirm LOT and lead time

D-3000 Series

D-3000 Series

D-3200M 2-Row High Voltage Drawer Types

Part Number Chart

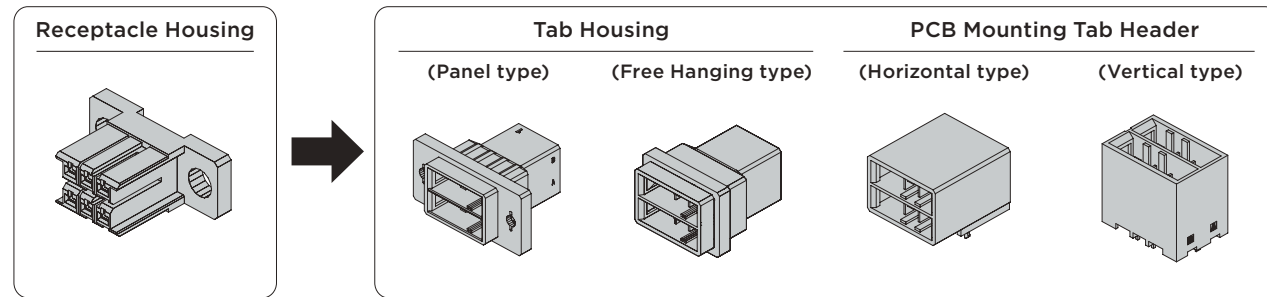

No of Pos.	Color	Key	Receptacle Housing	Plating	Tab Housing		PCB Mounting Tab Header	
					Panel Type	Free Hanging type	Horizontal type	Vertical type
6	Black	XX	1-917266-3	Gold	1-179555-3	1-179554-3	1-178139-2	1-178140-2
				Gold			1-178139-3	1-178140-3
				Tin			1-178139-5	1-178140-5

Related product information

Application Contact ...P.38
 Performance • Specifications ...P.35
 Accessories ...P.110, 112

Application

Compact Disk Device Application Examples

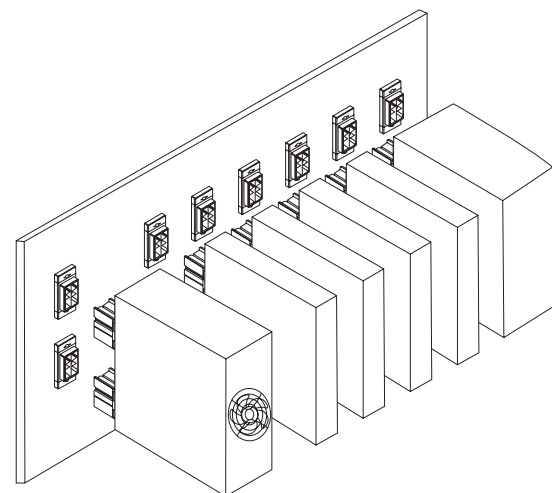

NOTE: All products are RoHS compliant On selection.
 You need to confirm LOT and lead time

D-3200M 2-Row High Voltage Drawer Types

Mating Dimension

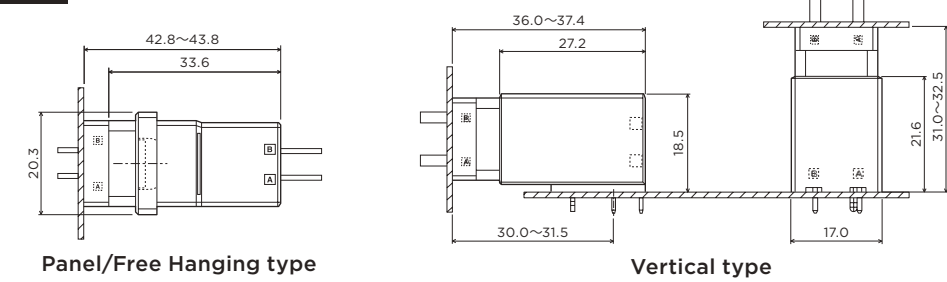

External Dimension

- Receptacle Housing (Drawer type)

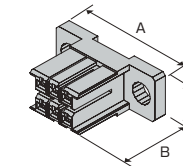

No.of Pos.	Keying	Plating	Color	Part Number	Dimensions		
					A	B	C
6	XX	-	Black	1-917266-3	40.0	25.7	15.4

- Tab Housing Panel type

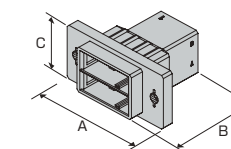

No.of Pos.	Keying	Plating	Color	Part Number	Dimensions		
					A	B	C
6	XX	-	Black	1-179555-3	41.9	33.6	20.3

- Free Hanging type

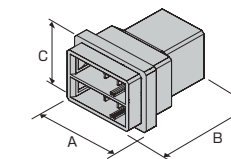

No.of Pos.	Keying	Plating	Color	Part Number	Dimensions		
					A	B	C
6	XX	-	Black	1-179554-3	28.1	33.6	20.3

NOTE: All products are RoHS compliant On selection.
 You need to confirm LOT and lead time

- PCB Mounting Tab Header Horizontal type

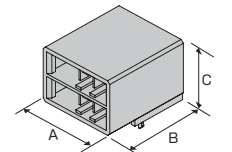

No.of Pos.	Keying	Plating	Color	Part Number	Dimensions		
					A	B	C
6	XX	Gold	Black	1-178139-2	24.2	27.2	18.5
		Gold	Black	1-178139-3			
		Tin	Black	1-178139-5			

- Vertical type

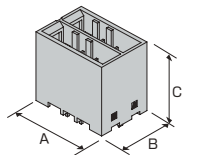

No.of Pos.	Keying	Plating	Color	Part Number	Dimensions		
					A	B	C
6	XX	Gold	Black	1-178140-2	24.2	17.0	21.6
		Gold	Black	1-178140-3			
		Tin	Black	1-178140-5			

D-3200T 3-Row High Voltage Modular Types

Part Number Chart

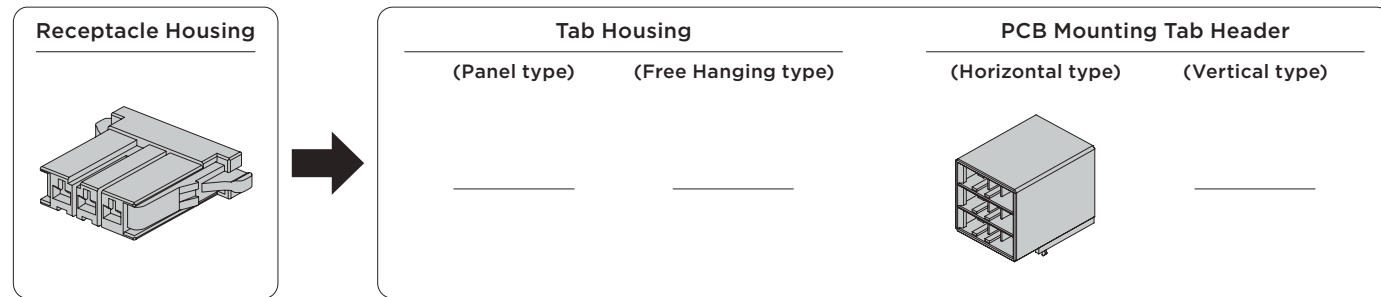

Receptacle Housing (maximum 9 Pos.)					
1 Row D-3200S ※1			2 Row D-3200M		
X	Y	Z	XX	YY	XY
3	-	-	-	-	-
1	-	-	1	-	-
2	1	-	-	-	-
1	-	-	-	-	1
-	1	-	1	-	-
1	-	-	-	1	-
1	2	-	-	-	-
2	1	-	-	-	-
1	-	-	-	-	1
1	1	1	-	-	-
1-178128-3	2-178128-3	3-178128-3	1-178129-6	2-178129-6	3-178129-6

PCB Mounting Tab Header			
Horizontal type D-3200T			
No. of Pos	Keying	Part Number	Plating
9	XXX	1-1123624-2	Gold
		1-1123624-5	Tin
	XXY	3-1123624-5	Tin
		4-1123624-5	Tin
	YYX	5-1123624-2	Gold
		5-1123624-5	Tin
XYZ	9-1123624-2	Gold	

Related product information

Application Contact ...P.38
 Performance • Specifications ...P.35
 ※1 refer to P.47

External Dimension

- Receptacle Housing

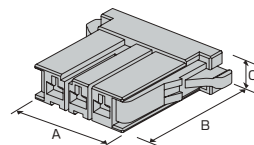

No. of Pos.	Keying	Plating	Color	Part Number	Dimensions		
					A	B	C
3	X	-	Black	1-178128-3	29.7	22.8	7.2
	Y	-	Black	2-178128-3			
	Z	-	Black	3-178128-3			
6	XX	-	Black	1-178129-6	27.3	22.8	14.8
	YY	-	Black	2-178129-6			
	XY	-	Black	3-178129-6			

Mating Dimension

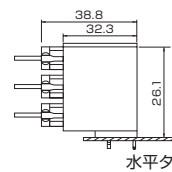

- PCB Mounting Tab Header
Horizontal type

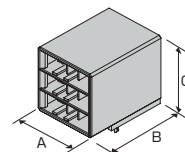

No. of Pos.	Keying	Plating	Color	Part Number	Dimensions		
					A	B	C
9	XXX	Gold	Black	1-1123624-2	24.2	32.3	27.1
		Tin	Black	1-1123624-5			
	XXY	Tin	Black	3-1123624-5			
		Tin	Black	4-1123624-5			
	YYX	Gold	Black	5-1123624-2			
		Gold	Black	9-1123624-2			

NOTE: All products are RoHS compliant On selection.
 You need to confirm LOT and lead time

D-3400F Skyscraper Connectors

Part Number Chart

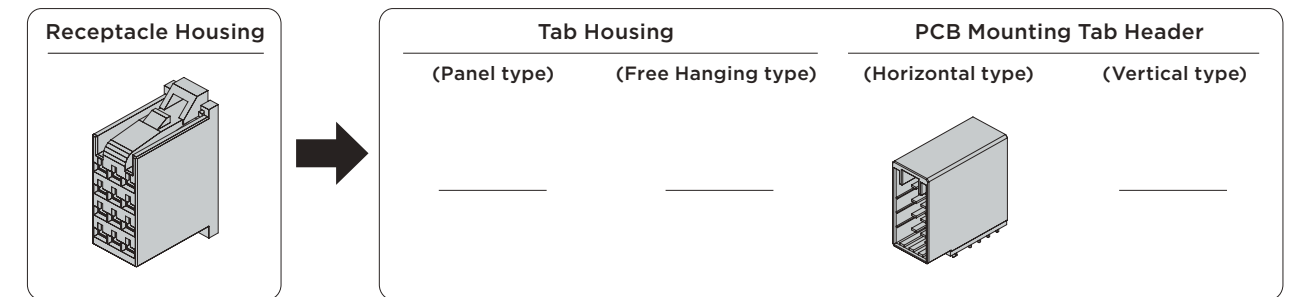

No of Pos.	Color	Key	Receptacle Housing	Plating	Tab Housing		PCB Mounting Tab Header	
					Panel Type	Free Hanging Type	Horizontal type	Vertical type
12	Black	-	178214-1	Gold	-	-	178216-2	-
				Gold	-	-	178216-3	-
				Tin	-	-	178216-5	-
20	Black	-	917249-1	Gold	-	-	917251-2	-
				Gold	-	-	917251-3	-
				Tin	-	-	917251-5	-
					-	-	-	-

Mating Dimension

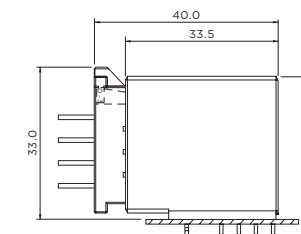

Horizontal type

External Dimension

- Receptacle Housing

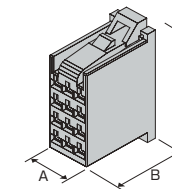

No. of Pos.	Keying	Plating	Color	Part Number	Dimensions		
					A	B	C
12	-	-	Black	178214-1	12.2	22.8	32.1
20	-	-	Black	917249-1	19.8	22.8	32.1

- PCB Mounting Tab Header
Horizontal type

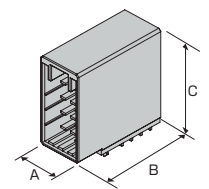

No. of Pos.	Keying	Plating	Color	Part Number	Dimensions		
					A	B	C
12	-	Gold	Black	178216-2	15.0	33.5	31.6
		Gold	Black	178216-3			
		Tin	Black	178216-5			
20	-	Gold	Black	917251-2	22.6	33.5	31.6
		Gold	Black	917251-3			
		Tin	Black	917251-5			

NOTE: All products are RoHS compliant On selection.
 You need to confirm LOT and lead time

D-3500D Sensor Connector

Part Number Chart

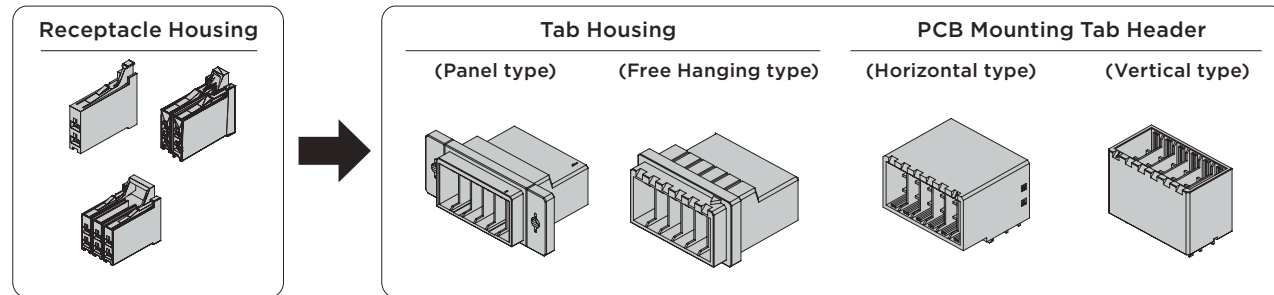

No. of Pos.	Color	Key	Receptacle Housing	Plating	Tab Housing			PCB Mounting TabHeader	
					Panel Type	Free Hanging Type	L Bracket	Horizontal	Vertical type
2	Black	-	175362-1	-	-	-	-	-	-
			175362-2						
			175362-3						
4	Black	-	175363-1	Gold	-	-	-	1376133-2	-
			White						
			1-175363-1						
			175363-2※1						
			2-175363-1						
175363-3									
6	Black	-	1318095-1	-	-	-	-	-	-
			1318095-2						
12	Black	-	-	Gold	917241-6 3-917241-6	917242-6 3-917242-6	S	177555-2	316516-2
				Gold				177555-3	316516-3
				Gold				1-177555-2	-
				Tin				177555-5	316516-5
20	Black	-	-	Gold	917241-8 3-917241-8	917242-8 3-917242-8	S	175365-2	316517-2
				Gold				175365-3	316517-3
				Gold				175365-5	316517-5
				Tin					

※1 Lever Small Type

Mating Dimension

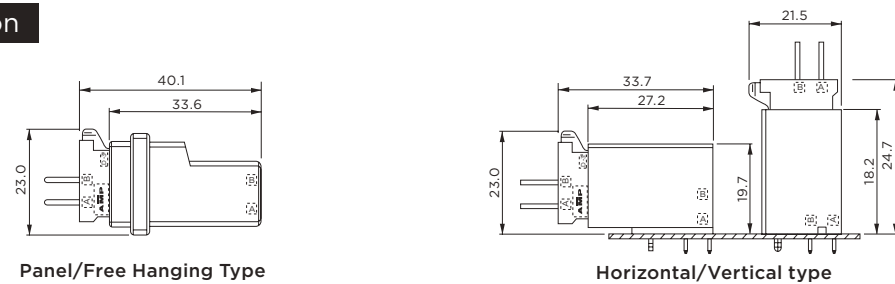

Related product information

Application Contact ...P.38
 Performance • Specifications ...P.35
 Accessories ...P.110, 112

NOTE: All products are RoHS compliant On selection.
 You need to confirm LOT and lead time

D-3500D Sensor Connector

External Dimension

• Receptacle Housing

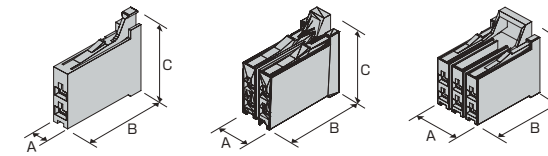

No. of Pos.	Keying	Plating	Color	Part Number	Dimensions		
					A	B	C
2	-	-	Black	175362-1	4.6	22.8	21.0
	-	-	Black	175362-2			
	-	-	Black	175362-3			
4	-	-	Black	175363-1	9.7	22.8	21.0
	-	-	White	1-175363-1			
	-	-	Blue	2-175363-1			
	-	-	Black	175363-2			
6	-	-	Black	175363-3	14.7	22.8	21.0
	-	-	Black	1318095-1			
				1318095-2			

• Tab Housing

Vertical type

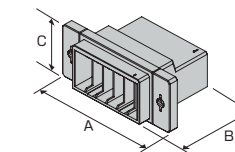

No. of Pos.	Keying	Plating	Color	Part Number	Dimensions		
					A	B	C
12	-	-	Black	917241-6	52.0	33.6	21.5
	-	-	Black	3-917241-6			
20	-	-	Black	917241-8	72.0	33.6	21.5
	-	-	Black	3-917241-8			

• Tab Housing

Free Hanging type

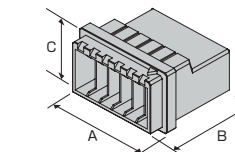

No. of Pos.	Keying	Plating	Color	Part Number	Dimensions		
					A	B	C
12	-	-	Black	917242-6	36.4	33.6	21.5
	-	-	Black	3-917242-6			
20	-	-	Black	917242-8	56.8	33.6	21.5
	-	-	Black	3-917242-8			

NOTE: All products are RoHS compliant On selection.
 You need to confirm LOT and lead time

• Board Mounting Tab Header

Horizontal type

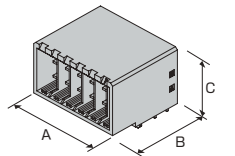

No. of Pos.	Keying	Plating	Color	Part Number	Dimensions		
					A	B	C
4	-	Gold	Black	1376133-2	12.2	27.2	19.7
12	-	Gold	Black	177555-2	32.5	27.2	19.7
	-	Gold	Black	177555-3			
	-	Tin	Black	177555-5			
20	-	Gold	Black	1-177555-2	52.8	27.2	19.7
	-	Gold	Black	175365-2			
	-	Gold	Black	175365-3			
				175365-5			

• Board Mounting Tab Header

Panel type

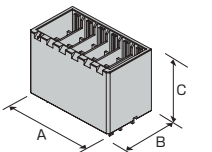

No. of Pos.	Keying	Plating	Color	Part Number	Dimensions		
					A	B	C
12	-	Gold	Black	316516-2	32.5	18.2	21.6
	-	Gold	Black	316516-3			
	-	Tin	Black	316516-5			
20	-	Gold	Black	316517-2	52.8	18.2	21.6
	-	Gold	Black	316517-3			
	-	Tin	Black	316517-5			

D - 3700 Servomotors Dedicated Connectors

Part Number Chart

Receptacle Connector Kit

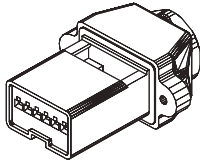

No. of Pos	Without Contact	Contacts (Model 1-175218 - 2). 6 included	Note
6	176346-7	176346-8	TÜ V approved products approval
6	1-176346-7	1-176346-8	-

D-3000 Series

Mating Dimension

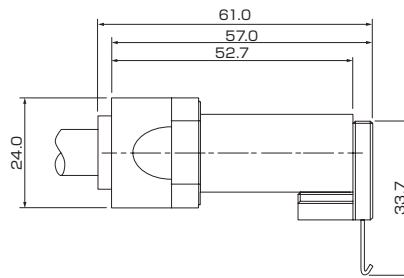

External Dimension

- Receptacle Connector Kit

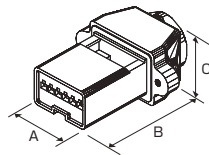

Without Contact

No. of Pos.	Keying	Plating	Color	Part Number	Dimensions		
					A	B	C
6	-	-	Black	176346-7	27.0	52.7	24.0
	-	-	Black	1-176346-7			

Contacts (1- 175218 - 2) 6 included

No. of Pos.	Keying	Plating	Color	Part Number	Dimensions		
					A	B	C
6	-	Gold	Black	176346-8	27.0	52.7	24.0
	-	Gold	Black	1-176346-8			

- Motor Side Tab Header
(offered for limited usage)

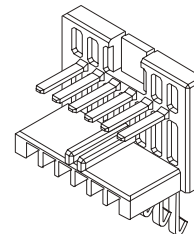

NOTE: All products are RoHS compliant On selection.
You need to confirm LOT and lead time

D-3900 and D-3950 Spring Clamp

D-3900 Spring Clamp

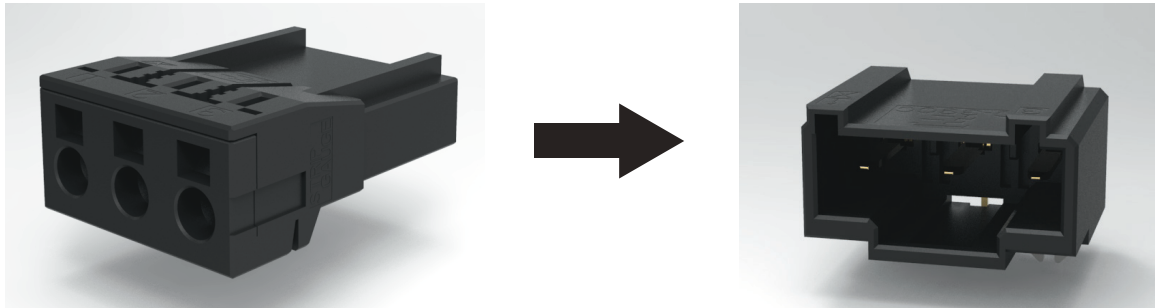

Receptacle Assembly

Board Mount Header Assembly

3900 Spring Clamp Parts List						
No. of Pos.	Color	Keying	Receptacle Assembly	Plating	Bound-Mounting Header Assembly (Horizontal type)	
3	Black	X	1-2013522-3 **	Gold	1-2013519-3	
	Black	X	1-2134249-3 *		4-2013519-3	
	Natural	Y	4-2013522-3		9-2013519-0	
7	Black	Z	9-2013522-0		1-2013519-0	
10	Black	X	1-2013522-0 **		2-2013519-0	
		X	1-2134249-0 *			
		Y	2-2013522-0			

* No Label

** Label Present

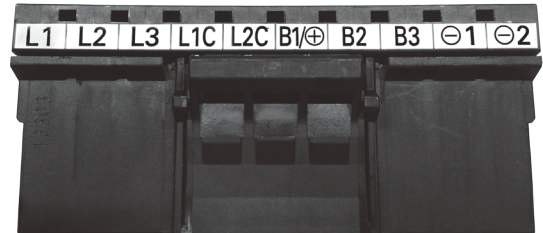
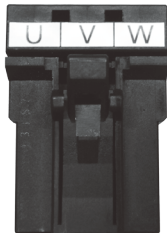

D-3950 Spring Clamp

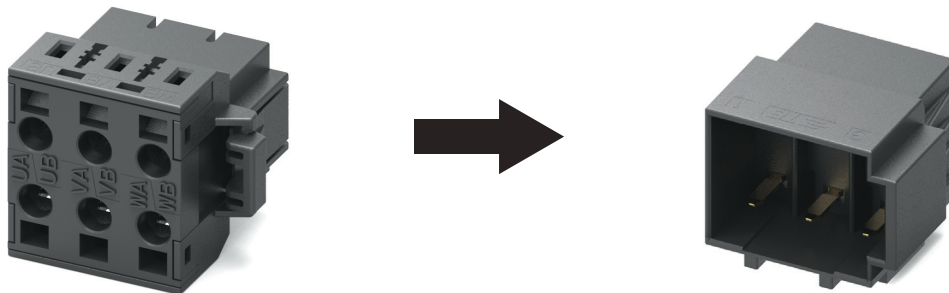

Receptacle Assembly

3950 Spring Clamp Parts List						
No. of Pos.	Color	Keying	Receptacle Assembly	Plating	Bound-Mounting Header Assembly (Horizontal type)	
3	Black	X	3-2229794-1	Gold	3-2229803-1	
6			2229800-1		2229806-1	
7			1-2229794-2		1-2229803-2	
11			1-2229794-1		1-2229803-1	

D-3000 Series

D-3900 and D-3950 Spring Clamp

D-3900 - Spring Clamp Dimensions

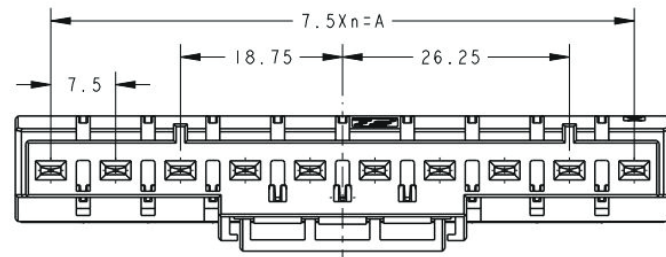

Receptacle Assembly

Electrical Specs for D-3900/3950 Series	
Maximum Current Rating (A)	14.5
Maximum Voltage Rating	300
Dielectric Withstanding Voltage	1500
Durability Cycles	500
Pitch	7.5mm
Wire Range	22522 AWG -- 14 AWG

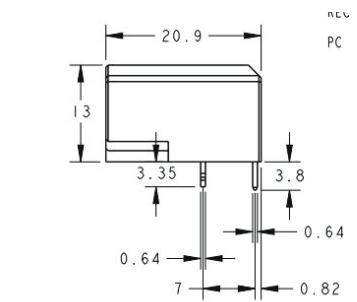
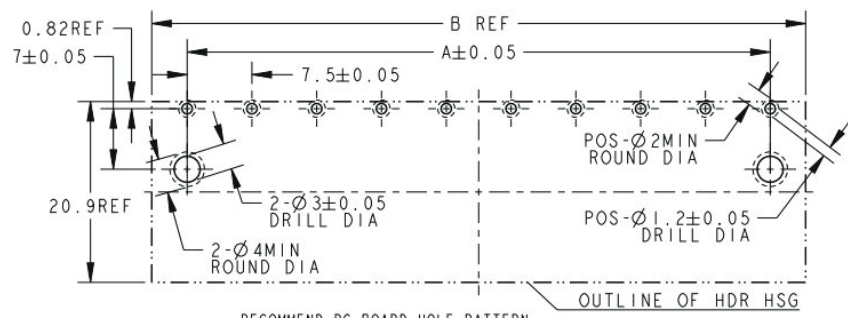

Board Mount Header Assembly

D-3950 - Spring Clamp Dimensions

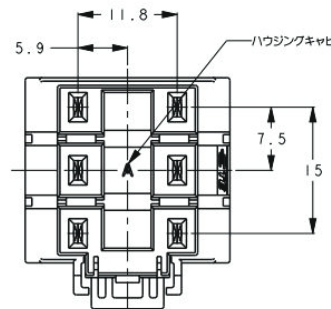

Receptacle Assembly

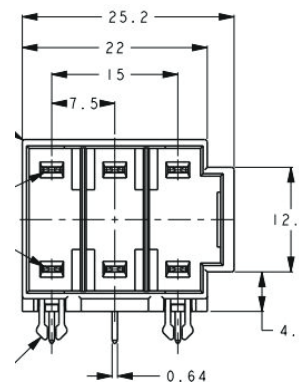

Board Mount Header Assembly

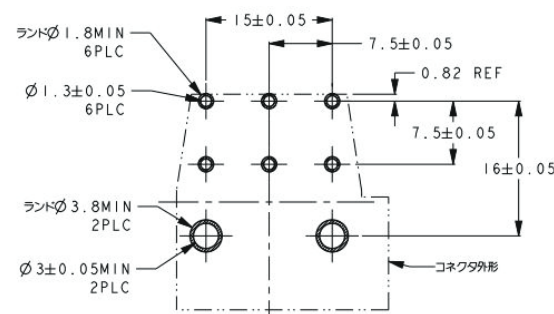
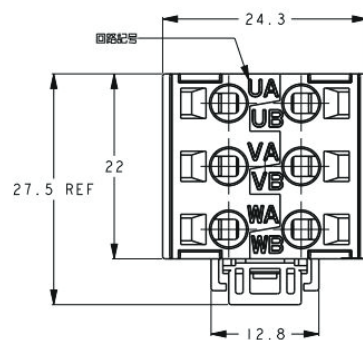

Dynamic Series Connectors

D-3900/D3950 - Spring Clamp Tool

Tool pictured in Receptacle Assembly

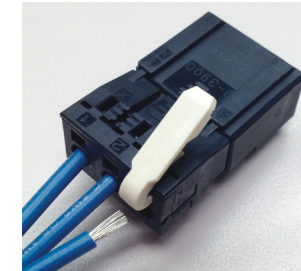

TE Part # 1981045-1
Used on both 3900 & 3950 Series Receptacle Assemblies

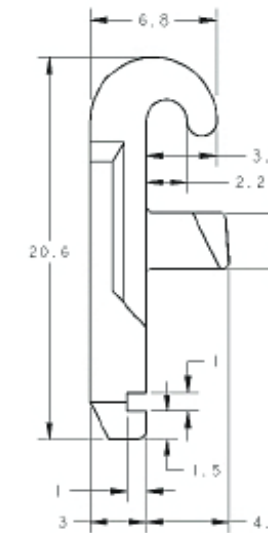

D-1900 - Spring Clamp Opener Tool

Tool pictured in Receptacle Assembly

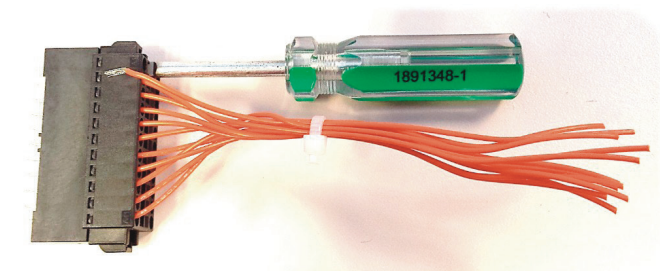

TE Part # 1891348-1
Used on all 1900 Series Receptacle Assemblies

Dynamic New Hand Tools

CS-10 Straight Action Tool

Series CS-10

The linear crimping series CS 10 is a smaller and lightweight when compared to other series.

Specifications

- Crimping of wire and insulation in one step
- Simple contact positioning even for mini contacts by flap-locator
- Outstanding crimping performance
- Can be equipped with integrated wire stripping device
- Easy handling due to outstanding force transmission ratio
- Small size
- Ergonomically designed soft handles
- Safe operation
- Wide range of application possibilities
- Releasable ratchet ensures the complete crimping process



AWG	
D1000 Series	CS-10 Straight Action Tool
22-20	2255142-1
28-22	2255140-1
28-26	2255141-1
30-28	2255139-1

AWG	
D2000 Series	CS-10 Straight Action Tool
22-18	2255144-1
28-24	2255143-1

AWG	
D3000 Series	CS-10 Straight Action Tool
16-14	2255149-1
16-14	2255148-1
20-16	2255147-1
24-20	2255146-1
28-24	2255146-1

D-4000 series

Series Introduction

These 24A power connectors are perfect for industrial machinery. They offer an optimal size for high current applications where space is an issue. Current capacity per unit volume is up 32% compared to the existing products.

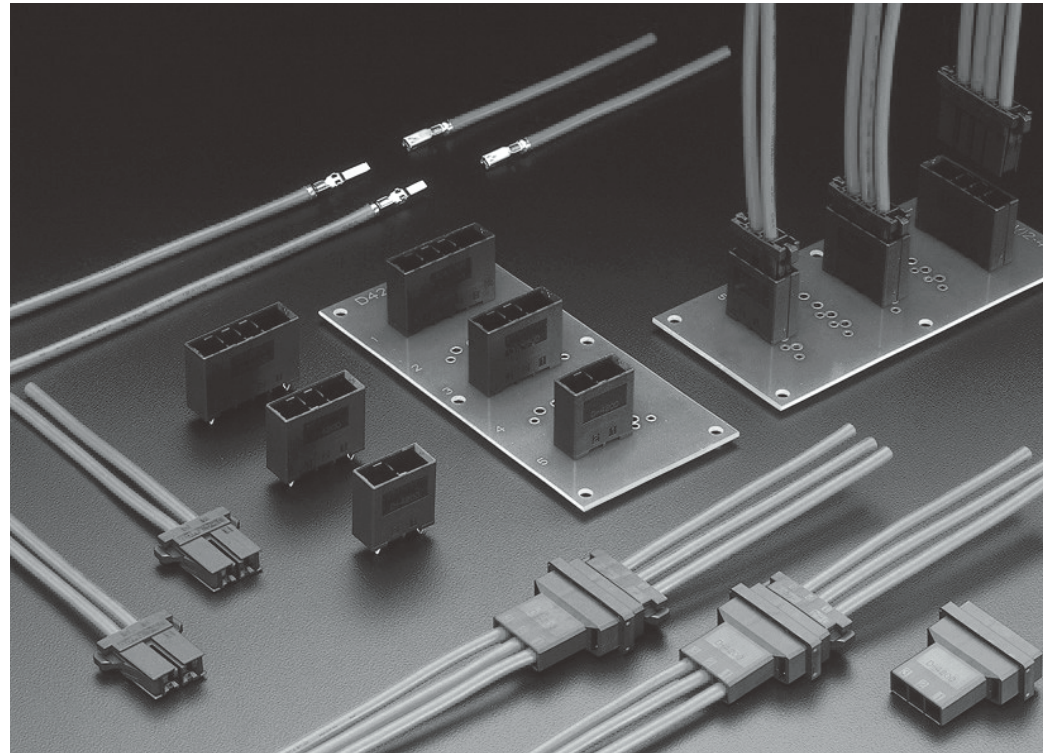

Product Features

- 1. Small Size/High Current Contact**
The contacts are newly-designed with 4 points of contact. This allows significantly improved current capacity (rated 24A maximum) as well as reliability.
- 2. The sequential contacts**
The sequential contact is a longer tab contact. When used in conjunction with the regular contacts it provides a ground that mates before the other power contacts.
- 3. High current tine (lead)**
PCB fixed type tine (lead) is the newly developed folded V-shaped tine. Larger contact area and smaller through-holes can make the PCB easier to pull the pattern through (pat. pending). New V shape tines (leads) were developed for mounting on boards. Even though a lot of on-board connection space is needed, through-holes were made as small as possible to make pattern design easy (patent pending).
- 4. Audible Latching**
On mating, an audible lock sound and sensation is transmitted to the assembler, so that even when working 'blind' mis-mating (or half-mating) problems are avoided.
- 5. Keying**
The housing has a keying (slit), so that by separating use of the X key and Y key mis-Mating is prevented.

D-4000 Series Performance & Specifications

Performance Specifications

Items	Pitch	250mil 6.35mm
Voltage Rating	600V AC(rms)/DC	
Current Rating	2 pole : 24A 3 pole : 23A 4 pole : 22A (AWG#16 for use as powersource)	
contact resistance	10mΩ max	
Dielectric Withstanding Voltage	2,500V AC (1 minute)	
Operating Temperature	-55°C-+105°C	

No. of Pos./Wire Size/Current Rating

Units: A (Amps).

No. of Pos.	Wire size (AWG)		
	12	14	16
2	24	21	16
3	23	20	15
4	22	19	14

Performance Specifications* Manual Materials & Construction

Product standards	108-78182	
Mounting application standard	114-5369	
Hand Tool Instruction Sheets	Crimp tool Part Number : 1762130-1 (M)	411-78174
	Crimp tool Part Number : 1762671-1 (M)★	411-78229
	Crimp tool Part Number : 1762129-1 (L)	411-78173
	Crimp tool Part Number : 1762670-1 (L)★	411-78195
Pulling tool 1762461-1 manual	411-78186	

Please order the manual concurrently .
An E-Catalogue is also available for download from the internet
★PEW12

Material & Completion

Category	Material	Completion
Receptacle Contact Tab Contact	Phosphorous Bronze Copper Alloy	Gold Plate (contact parts) Nickel Undercoat Gold Plate
Board side Tab Post	Phosphorous Bronze Copper Alloy	Tin Plate or (contact parts) Gold Plate Nickel Undercoat Gold Plate
Housing	UL94V-0 Glass-Reinforced Thermoplastic PBT	

Safety Specifications

The following safety standards have been approved based on the model number. Please check each model number to see whether it has been approved or not. In the meantime, please be aware that these may not match TE's own performance specifications.

Standard	Series	D-4200										
		Voltage Rating	Current Rating	Operating Temperature								
Product Standards 108-78182		600V AC/DC	24A AWG#12 2 pole load	-55 -+105								
UL File No.E28476		determined according to the requirements of	determined according to the requirements of	-								
CSA Report No. LR 7189		600V AC/DC	24A	-								
TÜV License No. R 50084673		600V AC/DC	<table border="1"> <thead> <tr> <th>AWG</th> <th>A(2-)</th> </tr> </thead> <tbody> <tr> <td>12</td> <td>24</td> </tr> <tr> <td>14</td> <td>21</td> </tr> <tr> <td>16</td> <td>16</td> </tr> </tbody> </table>	AWG	A(2-)	12	24	14	21	16	16	-55 -+105
AWG	A(2-)											
12	24											
14	21											
16	16											

D-4000 series Products List by Applications

D-4200S

High-current type

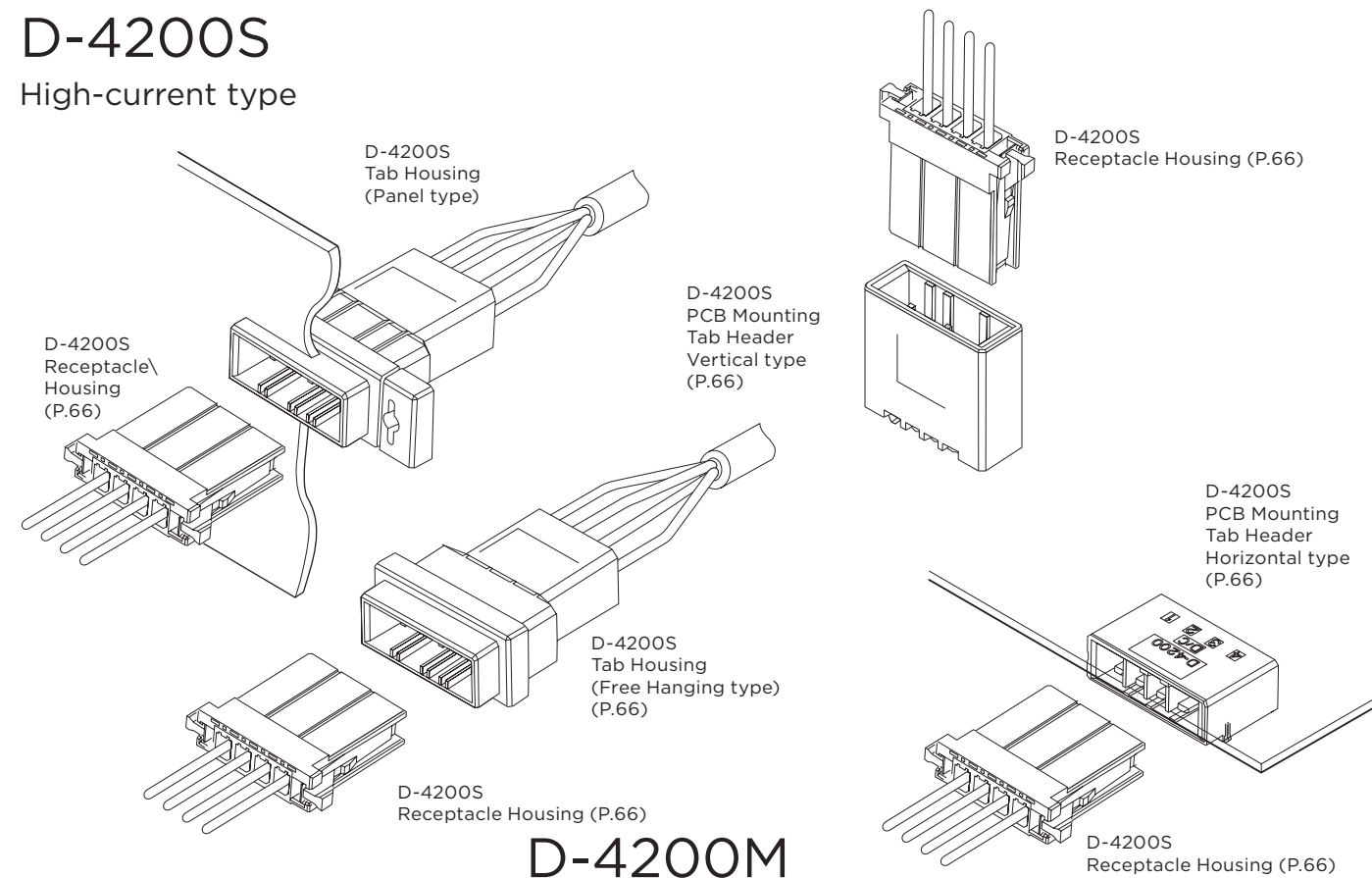

D-4200M

High Current modular type

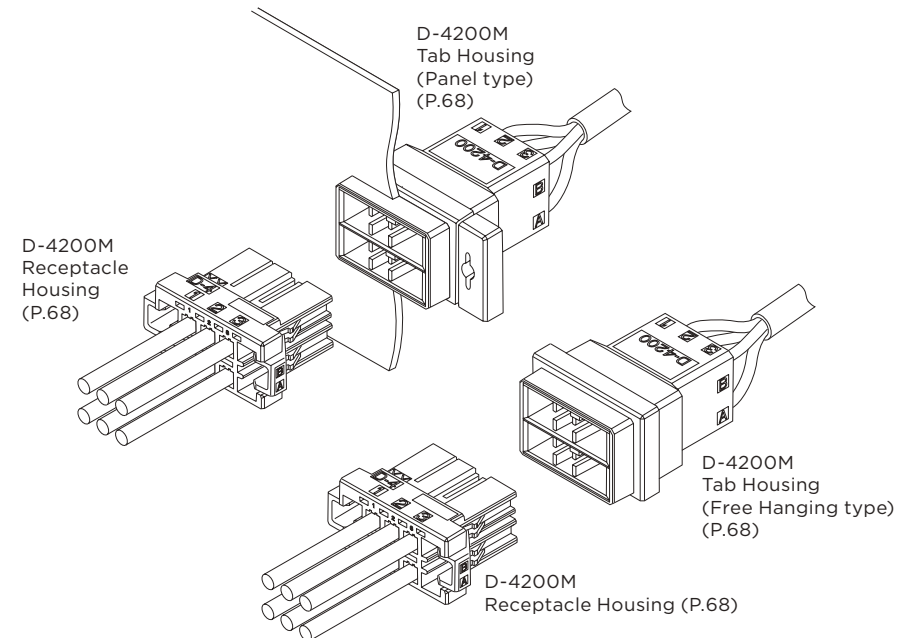

D-4000 series Contact

- Crimp type
(gold plating thickness 0.38µm)

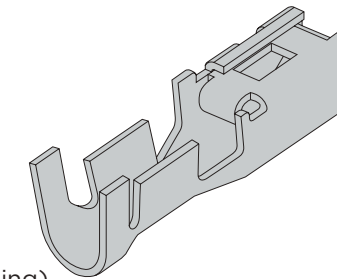

Receptacle Contact
(used in Receptacle Housing)

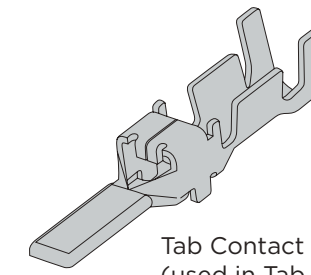

Tab Contact
(used in Tab Housing)

Applicable Wiring Range		Insulation Wire Outer Diameter mm	Wire Range Mark	Contact Part Number						Applicable Tool Product number	
				Receptacle Contact		Tab Contact		Sequential Long Tab Contact		hand tool CCI hand tool PEW12 hand tool* PEW12 dice only	Mini Applicator
AWG	mm ²			Strip Form	Loose Piece	Strip Form	Loose Piece	Strip Form	Loose Piece		
16 14	1.25 2.20	2.0-3.2 2.8-3.75	M	1747418-2	1747499-2	1747419-2	1747501-2	1-1747419-2	1-1747501-2	1762130-1 1762671-1* 1762675-1	1762120-2
14 12	2.20 3.50	2.9-3.8 3.8-4.2	L	1747415-2	1747498-2	1747416-2	1747500-2	1-1747416-2	1-1747500-2	1762129-1 1762670-1* 1762674-1	1762119-2

Note: when placing your order, please check the sale slots. Please contact our sales department or purchase distributor for more information.

For mini applicator please contact the sales department. The connected contact is for use with mini applicator (bench machine), the loose contact is for use with hand tools. PEW 12 is a Dice exchange-type hand tool. * refers to the Dice exchange-type hand tool with product number - 9-1478240-0

The receptacle contact can be used in all receptacle housings, the tab contact can be used in all tab housings. Details of the applicable tool are available from P. 107

NOTE: All products are RoHS compliant On selection. You need to confirm LOT and lead time

D-4200S 1-Row High Voltage

Part Number Chart

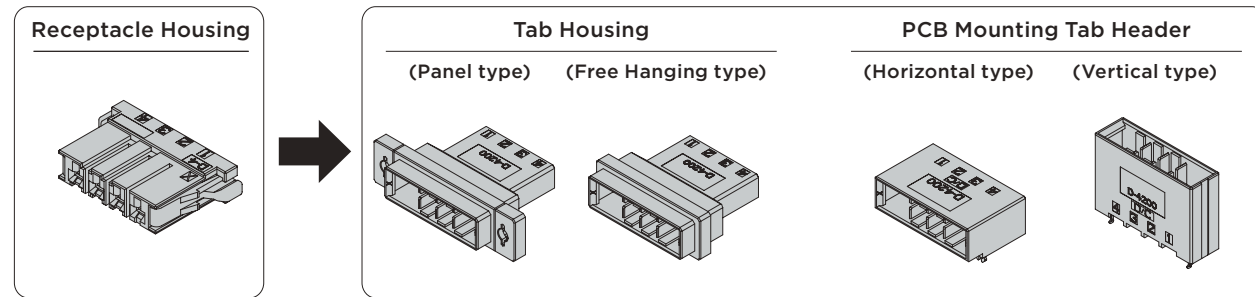

No. of Pos.	Color	Key	Receptacle Housing	Plating	Tab Housing		PCB Mounted Tab Header			
					Panel Type	Free Hanging Type	Horizontal type		Vertical type	
							Standard type	Sequential type	Standard type	Sequential type
2	Black	X	1-1747276-2	Gold	1-1747535-2	1-1747414-2	1-1903328-2	-	1-1747277-2	-
	Black	Y	2-1747276-2	Gold	2-1747535-2	2-1747414-2	2-1903328-2	-	2-1747277-2	-
3	Black	X	1-1747276-3	Gold	1-1747535-3	1-1747414-3	1-1903328-3	5-1903328-3	1-1747277-3	5-1747277-3
	Black	Y	2-1747276-3	Gold	2-1747535-3	2-1747414-3	2-1903328-3	6-1903328-3	2-1747277-3	6-1747277-3
4	Black	X	1-1747276-4	Gold	1-1747535-4	1-1747414-4	1-1903328-4	5-1903328-4	1-1747277-4	5-1747277-4
	Black	Y	2-1747276-4	Gold	2-1747535-4	2-1747414-4	2-1903328-4	6-1903328-4	2-1747277-4	6-1747277-4

Related product information

Application Contact ...P.38
Performance • Specifications

Application

Robot/Robot Controller Application Example

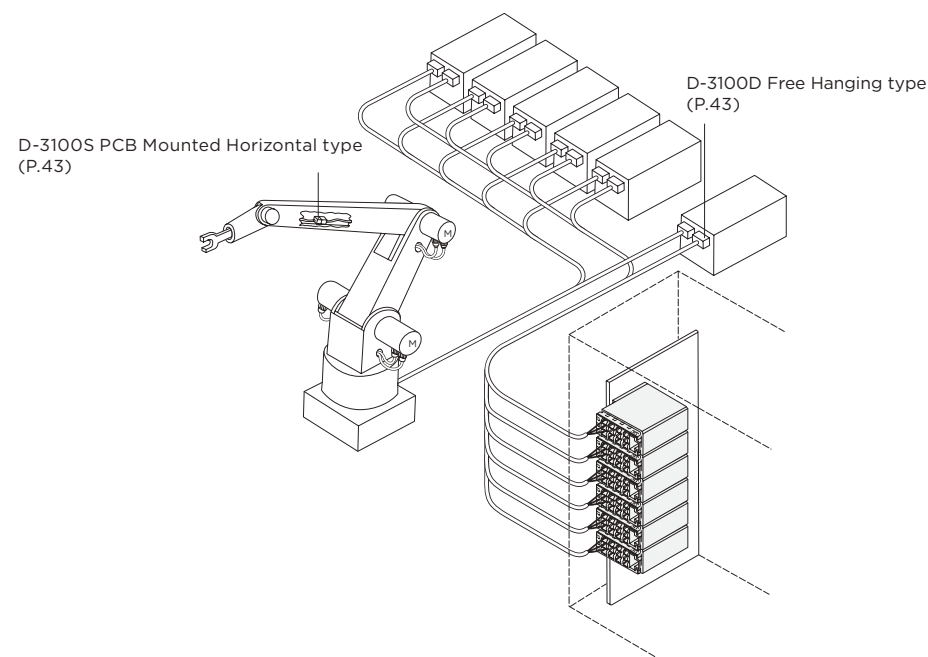

NOTE: All products are RoHS compliant On selection. You need to confirm LOT and lead time

D-4200S 1-Row High Voltage type

Mating Dimension

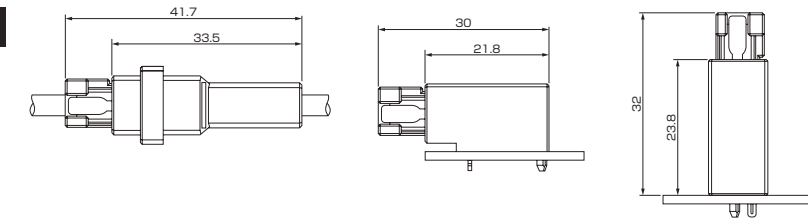

External Dimension

• Receptacle Housing

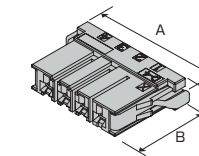

No. of Pos.	Keying	Plating	Color	Part Number	Dimensions		
					A	B	C
2	X	-	Black	1-1747276-2	27.4	23.0	8.5
	Y	-	Black	2-1747276-2			
3	X	-	Black	1-1747276-3	33.7	23.0	8.5
	Y	-	Black	2-1747276-3			
4	X	-	Black	1-1747276-4	40.1	23.0	8.5
	Y	-	Black	2-1747276-4			

• Tab Housing

Panel type C

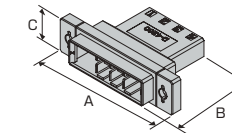

No. of Pos.	Keying	Plating	Color	Part Number	Dimensions		
					A	B	C
2	X	-	Black	1-1747535-2	40.0	33.5	13.8
	Y	-	Black	2-1747535-2			
3	X	-	Black	1-1747535-3	46.0	33.5	13.8
	Y	-	Black	2-1747535-3			
4	X	-	Black	1-1747535-4	53.0	33.5	13.8
	Y	-	Black	2-1747535-4			

Free Hanging type

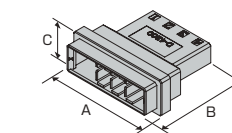

No. of Pos.	Keying	Plating	Color	Part Number	Dimensions		
					A	B	C
2	X	-	Black	1-1747414-2	26.4	33.5	13.8
	Y	-	Black	2-1747414-2			
3	X	-	Black	1-1747414-3	32.7	33.5	13.8
	Y	-	Black	2-1747414-3			
4	X	-	Black	1-1747414-4	39.1	33.5	13.8
	Y	-	Black	2-1747414-4			

NOTE: All products are RoHS compliant On selection. You need to confirm LOT and lead time

• Board Mounting Tab Header

Horizontal type

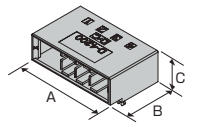

No. of Pos.	Keying	Plating	Color	Part Number	Dimensions		
					A	B	C
2	X	Gold	Black	1-1903328-2	22.4	21.8	11.9
	Y	Gold	Black	2-1903328-2			
3	X	Gold	Black	1-1903328-3	28.7	21.8	11.9
	Y	Gold	Black	2-1903328-3			
	X	Gold	Black	5-1903328-3*1			
	Y	Gold	Black	6-1903328-3*1			
4	X	Gold	Black	1-1903328-4	35.1z	21.8	11.9
	Y	Gold	Black	2-1903328-4			
	X	Gold	Black	5-1903328-4*1			
	Y	Gold	Black	6-1903328-4*1			

*1 sequential type

Vertical type

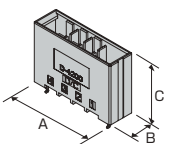

No. of Pos.	Keying	Plating	Color	Part Number	Dimensions		
					A	B	C
2	X	Gold	Black	1-1747277-2	22.4	10.4	23.8
	Y	Gold	Black	2-1747277-2			
3	X	Gold	Black	1-1747277-3	28.7	10.4	23.8
	Y	Gold	Black	2-1747277-3			
	X	Gold	Black	5-1747277-3*1			
	Y	Gold	Black	6-1747277-3*1			
4	X	Gold	Black	1-1747277-4	35.1	10.4	23.8
	Y	Gold	Black	2-1747277-4			
	X	Gold	Black	5-1747277-4*1			
	Y	Gold	Black	6-1747277-4*1			

*1 sequential type

D-4200M 2-Row High Current Modular Type

Part Number Chart

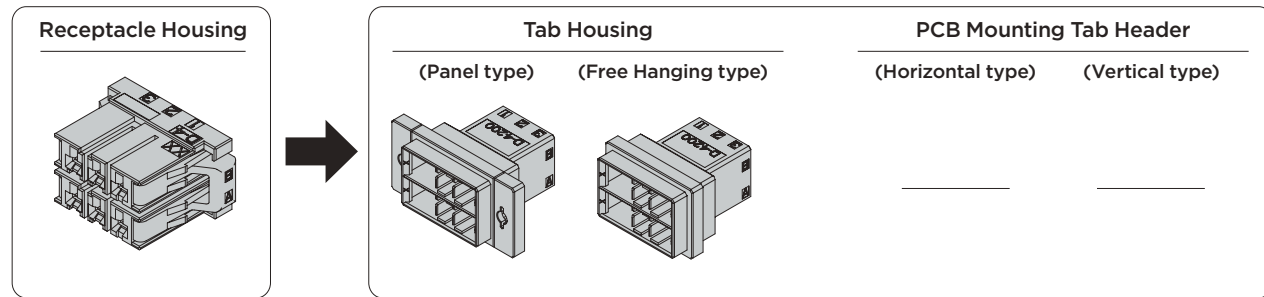

No of Pos.	Color	Key	Receptacle Housing	Plating	Tab Housing		PCB Mounting Tab Header	
					Panel Type	Free Hanging Type	Horizontal type	Vertical type
6	Black	XX	1-1903329-3	-	1-1903331-3	1-1903330-3	-	-
	Black	YY	2-1903329-3	-	2-1903331-3	2-1903330-3	-	-
	Black	XY	3-1903329-3	-	3-1903331-3	3-1903330-3	-	-

Related product information

Application Contact ...P.65
Performance • Specifications ...P.63

Mating Dimension

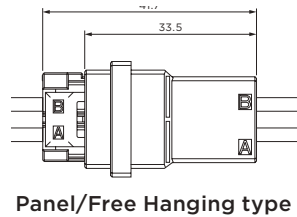

External Dimension

• Receptacle Housing

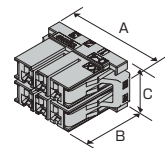

No.of Pos.	Keying	Plating	Color	Part Number	Dimensions		
					A	B	C
6	XX	-	Black	1-1903329-3	33.7	23.0	17.3
	YY	-	Black	2-1903329-3			
	XY	-	Black	3-1903329-3			

• Tab Housing
Panel type

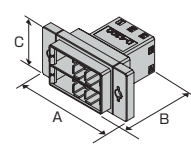

No.of Pos.	Keying	Plating	Color	Part Number	Dimensions		
					A	B	C
6	XX	-	Black	1-1903331-3	46.0	33.5	22.6
	YY	-	Black	2-1903331-3			
	XY	-	Black	3-1903331-3			

Free Hanging type

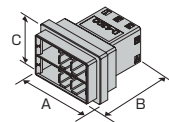

No.of Pos.	Keying	Plating	Color	Part Number	Dimensions		
					A	B	C
6	XX	-	Black	1-1903330-3	32.7	33.5	22.6
	YY	-	Black	2-1903330-3			
	XY	-	Black	3-1903330-3			

NOTE: All products are RoHS compliant On selection. You need to confirm LOT and lead time

D-5000 Series

Series Introduction

The Dynamic 5000 series was developed for up to 45 amperes in response to the demand for improved reliability and productivity for the main power lines in equipment. They can be used for a variety of applications as replacements for terminal blocks, or round terminals. It is compact but with a high current capacity. In addition, it has a wide variety of housings to cover all applications from PCB to internal wiring distributions. The D-5000 series is right for high current power line applications where reliability cannot rest only on operator's skills

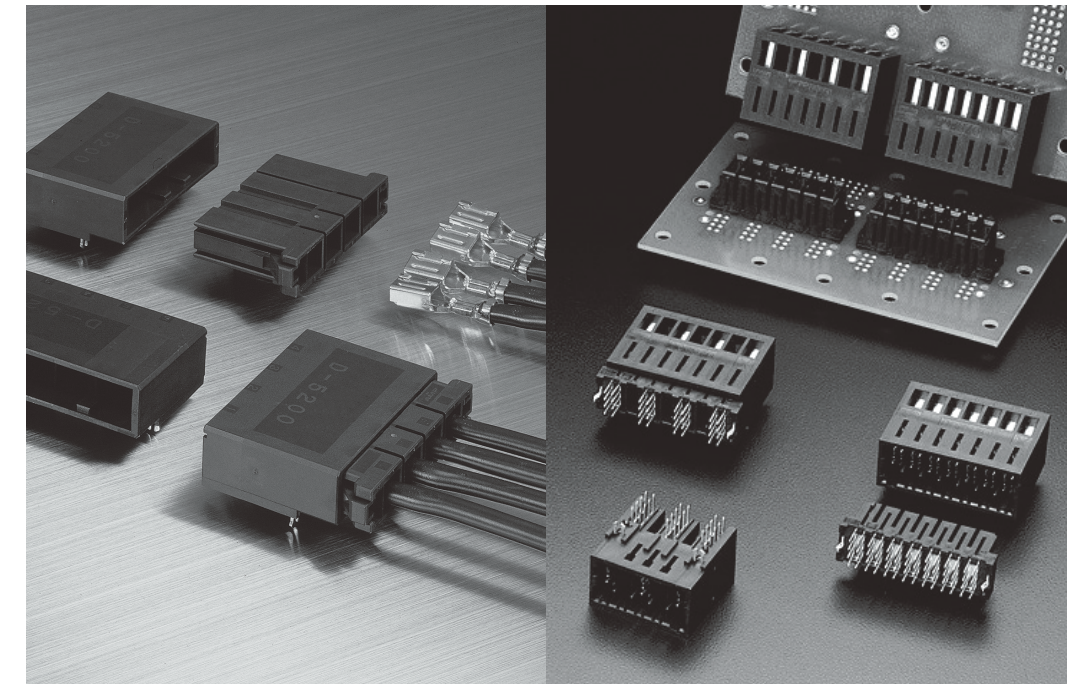

Product Features

- High Current Contact**
The D-5000 series uses the same 'twis-resistant' box shape contact as the rest of the Dynamic series contacts. The material is the same copper alloy developed for the D-3000 series with its superior elasticity and conductivity, which results in a reliable, robust contact capable of high current. Silver plating is also available for high amperage applications.
- The Sequential Mating** means that the build up of static charge in the sequential contact is grounded first at mating. The long tab was developed for sequential connection of tab contacts. By using both this and standard tab contacts, sequential connectibility is enhanced.
- Tines (leads) for High Amperage**
The tines (leads) for on-board mounting are a newly developed twin-lead type. It is possible to reliably join patterns and connectors because a wide area of PCBs can be allocated. New V shape tines (leads) were developed for mounting on boards. Even though a lot of on-board connection space is needed, through-holes were made as small as possible to make pattern design easy (patent pending).
- IP20 (Protection from the approach of the finger)**
D-5300 is recommended for applications with a supply side in the IP20 apparatus. By using a housing on the apparatus side (panel side) which can accommodate the receptacle contact, the apparatus side connector meets IP20 rating.

D-5000 Series Performance & Specifications

Performance Specifications/Wire Size/Current Rating

Item	D-5200	D-5300	D-5200 α
Pitch	10.16mm		
Current Rating	30A max		45A max
Voltage Rating	630V AC / DC		
Dielectric Withstanding voltage	3000VAC		
Total Resistance	2mΩmax		
Insertion Strength	9.8Nmax (per pole)		
Withdrawal Strength	1.96Nmin (per pole)		
Durability	50 times (Gold0.76μm/hour)		
Lock Strength	98Nmin		

Pos. Number/Wire Size/Current Rating

Units: A (Amps).

No. of Pos	Series	Wire Size(AWG)							
		20	18	16	14	12	10	8	
6	D-5200	-	-	16	19	25	30	-	
4	D-5300	-	-	16	19	25	30	-	
3	D-5200 α	12	16	20	25	33	38	45	
4		12	15	18	23	31	35	43	

Performance Specifications* Manual Materials & Construction

Product Standards	108-5453	
Test Report	501-5188	
Mounting Application Standard	114-5206	
hand tool instruction sheets	Crimping Tool Product Number : 234170-1	411-5712
	Crimping Tool Product Number : 234171-1	411-5713
	Crimping Tool Product Number : 91596-1	408-8547-1
	Crimping Tool Product Number : 1366044-1	411-5976
Withdrawal Tool (product number : 409158-1) Manual	411-5774	

please order the manual concurrently An E-Catalogue is also available for download from the internet

Material & Completion

Category	Item	D-5200	D-5300	D-5200α
Contact	Material	Copper Alloy		
	Finishing	Nickel Undercoat Gold Plating	Nickel Undercoat Gold/Silver Plating	Nickel Undercoat Gold Plating
Board Side Tab Post	Material	Copper Alloy	-	Copper Alloy
	Finishing	Nickel Undercoat Gold Plating	-	Nickel Undercoat Silver Plating
Housing	Material	UL94V-0, glass-reinforced thermoplastic PBT		

Safety Specifications

The following safety standards have been approved based on the part number. Please check each model number to see whether it has been approved or not. In the meantime, please be aware that these may not match TE's own performance specifications.

Series Standard	D - 5200 series (400 mill, 10.16 mm pitch).			D-5200Mα Series																																							
	Voltage Rating	Current Rating	Temperature Rating	Voltage Rating	Current Rating	Temperature Rating																																					
product standards 108-5453	630V AC/DC	(see above).	-55°C ~+105°C	-	(see above).	-55°C ~+105°C																																					
UL File No.E28476 (Recognized Component)	determined according to the requirements of the machine in use	determined according to the requirements of the machine in use	-	-	determined according to the requirements of the machine in use	-																																					
CSA Report No. LR 7189	h600V AC/DC	<table border="1"> <tr><th>AWG</th><th>A</th></tr> <tr><td>16</td><td>13</td></tr> <tr><td>14</td><td>18</td></tr> <tr><td>12</td><td>25</td></tr> <tr><td>10</td><td>30</td></tr> </table>	AWG	A	16	13	14	18	12	25	10	30	-	-	-																												
AWG	A																																										
16	13																																										
14	18																																										
12	25																																										
10	30																																										
TÜV License No. R9650368 IP protection IP -00. overvoltage classification (II) number of insert / withdrawal repetitions 50 times	600V AC/DC	<table border="1"> <tr><th>AWG</th><th>A</th></tr> <tr><td>16</td><td>15</td></tr> <tr><td>14</td><td>20</td></tr> <tr><td>12</td><td>25</td></tr> <tr><td>10</td><td>30</td></tr> </table>	AWG	A	16	15	14	20	12	25	10	30	-30°C ~+105°C	-	<table border="1"> <tr><th>AWG</th><th colspan="2">A</th></tr> <tr><td></td><td>1-3</td><td>4</td></tr> <tr><td>20</td><td>12.5</td><td>12.5</td></tr> <tr><td>18</td><td>17.5</td><td>16</td></tr> <tr><td>16</td><td>21</td><td>19.5</td></tr> <tr><td>14</td><td>26</td><td>24</td></tr> <tr><td>12</td><td>33</td><td>31</td></tr> <tr><td>10</td><td>40</td><td>37.5</td></tr> <tr><td>8</td><td>48</td><td>46</td></tr> </table>	AWG	A			1-3	4	20	12.5	12.5	18	17.5	16	16	21	19.5	14	26	24	12	33	31	10	40	37.5	8	48	46	-30°C ~+105°C
AWG	A																																										
16	15																																										
14	20																																										
12	25																																										
10	30																																										
AWG	A																																										
	1-3	4																																									
20	12.5	12.5																																									
18	17.5	16																																									
16	21	19.5																																									
14	26	24																																									
12	33	31																																									
10	40	37.5																																									
8	48	46																																									

D-5000 Series List of Products by Application

D-5200S

High Voltage
1-Row Type

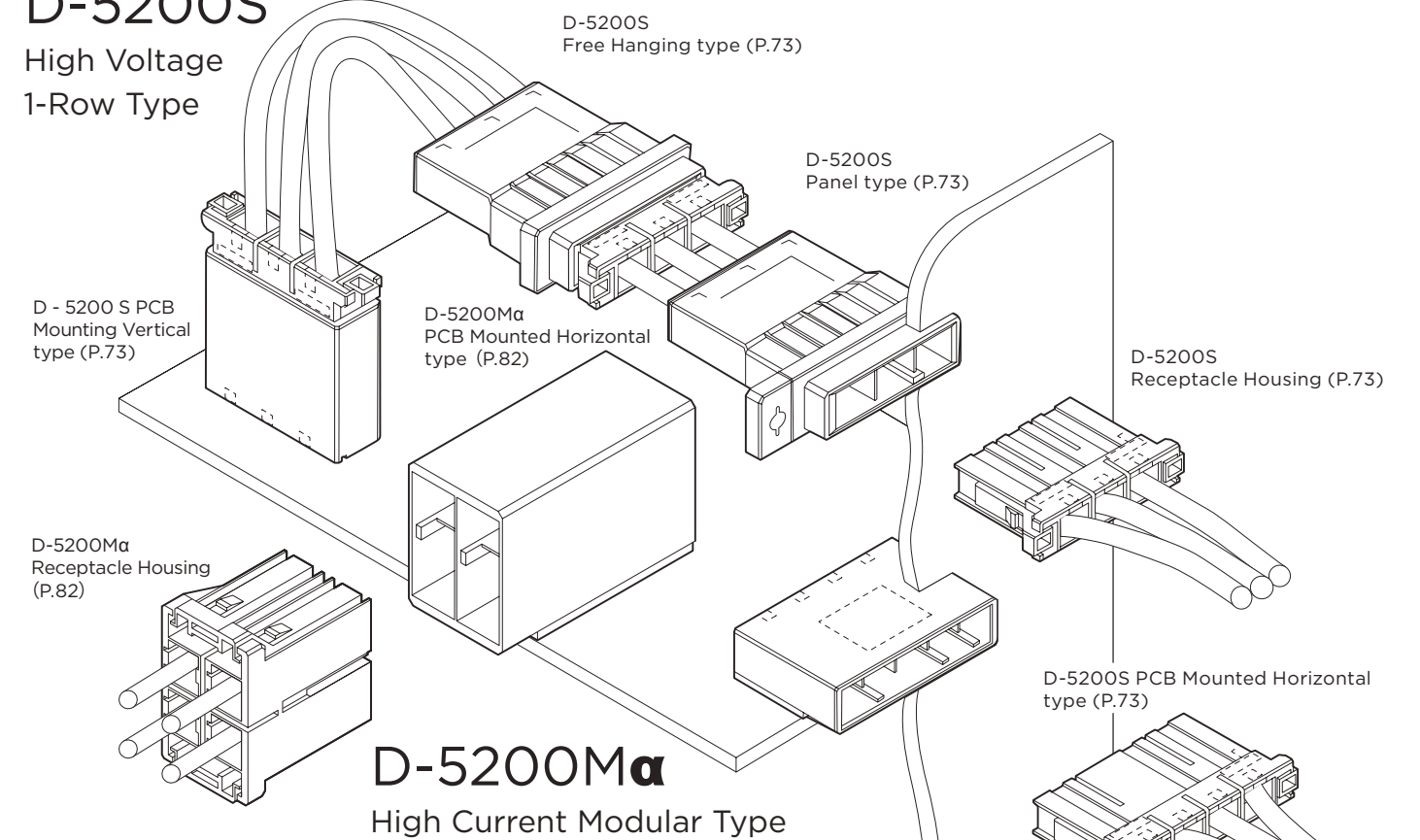

D-5200Mα
High Current Modular Type

D-5200M

High Voltage
Modular Type

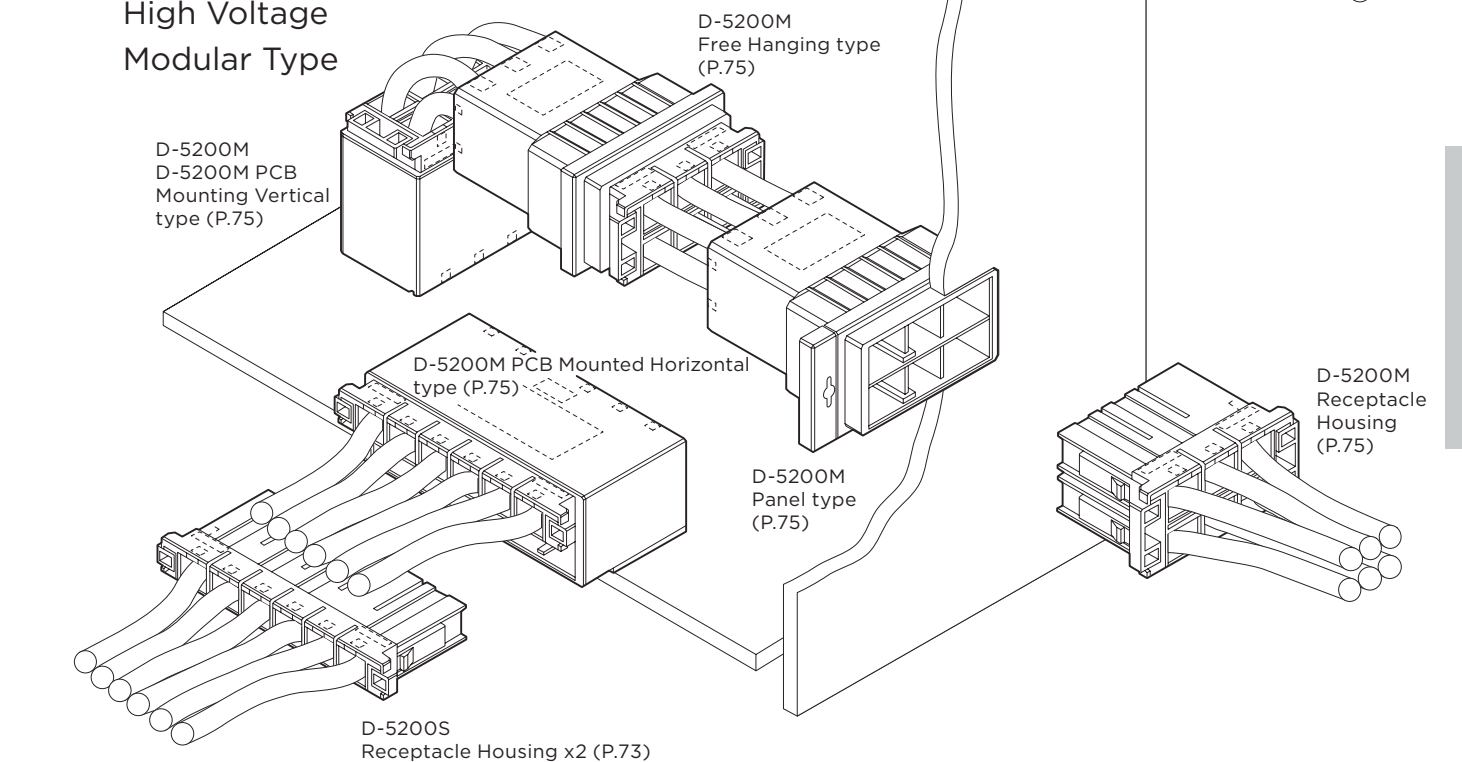

D-5000 Series Contact

- Crimp type

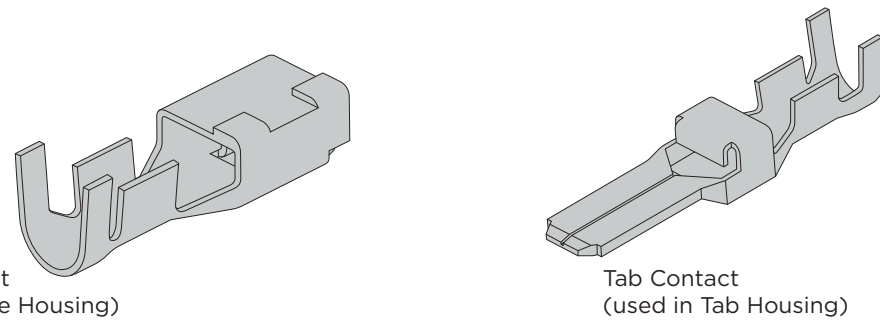

- gold-plated, silver-plated type

Applicable Wiring Range	Insulation Wire outer diameter mm	Wire Range Mark	Contact Part Number			Tool Part Number	
			Receptacle Contact	Tab Contact	Sequential Tab Contact	Mini-Applicator	Hand Tool
20	0.50	1.8-2.83	Strip Form 1318985-2 1318985-3 1318985-6	-	-	1528106-2	-
16	1.25	2.35-3.23		Loose Form 1318986-2 1318986-3 1318986-6	-	-	-
16	1.25	3-3.80	Strip Form 179955-2 179955-3	917802-2 917802-3	84696-1	1366659-2	-
14	2.20			Loose Form 316040-2 316040-3 316040-6	917804-2 917804-3 917804-6	2013594-1	-
12	3.50	4-5.2	Strip Form 179956-2 179956-3	917803-2 917803-3	84695-1	1366660-2	-
10	5.50			Loose Form 316041-2 316041-3 316041-6	917805-2 917805-3 917805-6	2013593-1	-
8	8.00	4.9-7.8	Strip Form 1318696-2	-	-	1366658-3	-
				Loose Form 1318697-2	1747443-6	-	-

Note:

The part number suffix is the code for plating.

- 1: 0.2 m thick gold plated
- 2: 0.38 m thick gold plated
- 3: 0.76 m thick gold plated
- 6: 2.54 m thick gold plated

Minimum order quantity is provided for each product. When ordering, specify your requirements by multiplying the quantity set for each.

Mini-Applicator is for use on Automachine.

Strip Form contacts are used with Mini-Applicator and Loose-Piece contacts are with hand tools.

- For more information please refer to P.109
- If you have any questions please contact AT tooling Sales Department (044 - 900 - 5027)

- Electro-hydraulic tool PN2155369 -1 for use with 16 AWG to 8 AWG wire

The receptacle contact can be used in all receptacle housings, the tab contact can be used in all tab housings

NOTE: All products are RoHS compliant On selection. You need to confirm LOT and lead time

D-5200S 1 Row High Current Type

Part Number Chart

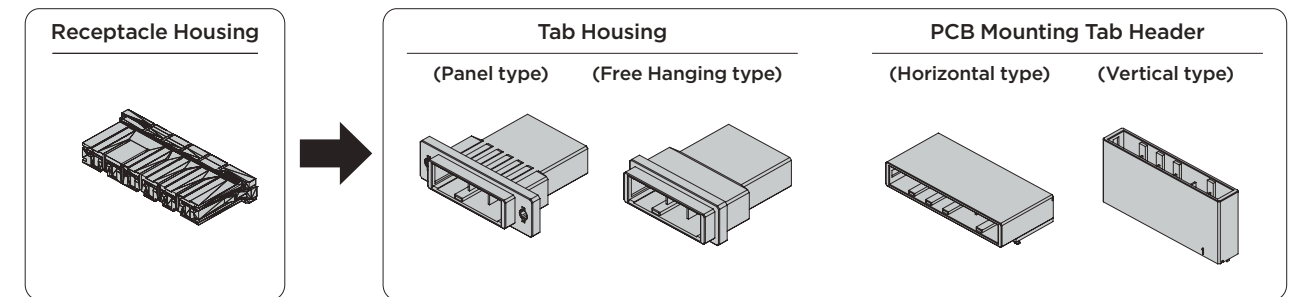

No. of Pos.	Color	Key	Receptacle Housing	Plating	Tab Housing		PCB Mounted Tab Header								
					Panel type	Free Hanging type	Horizontal type		Vertical type						
							Standard type	Sequential type	Standard type	Sequential type					
2	Black	X	1-179958-2	Gold	1-353047-2	1-353046-2	1-353079-2	-	1-353080-2	-					
	Gold			1-353079-3			-	1-353080-3	-						
	Black	Y		2-179958-2	Gold	2-353047-2	2-353046-2	-	-	6-353080-2	-				
	Gold				-			-	2-353080-3	-					
3	Black	X	1-179958-3		Gold	1-353047-3	1-353046-3	1-353081-2	8-353081-2	1-353082-2	8-353082-2				
	Gold				1-353081-3			-	1-353082-3	-					
	Black	Y		2-179958-3	Gold	2-353047-3	2-353046-3	-	-	-	-				
	Gold				2-353081-3			-	2-353082-3	-					
4	Black	X	1-179958-4		Gold	(D-5200M 2 row 4, 6 pole as in P 75)		1-917541-2	8-917541-2	1-917542-2	8-917542-2				
	Gold				1-917541-3			-	1-917542-3	-					
	Black	Y		2-179958-4	Gold			2-917541-2		-	-	2-917542-2	-		
	Gold				-					-	2-917542-3	-			
6	Black	X	1-179958-6		Gold			1-179959-2	-	1-179960-2	-				
	Gold				1-179959-3			-	1-179960-3	-					
	Black	Y		2-179958-6	Gold			2-179959-2		-	-	6-179960-2	-		
	Gold				2-179959-3					-	2-179960-3	-			
	Black				7-179959-3							-	-	7-179960-3	-
	Gold											-	-	7-179960-2	-

Related product information

- Application Contact ...P.72
- Performance • Specifications ...P.70

Mating Dimension

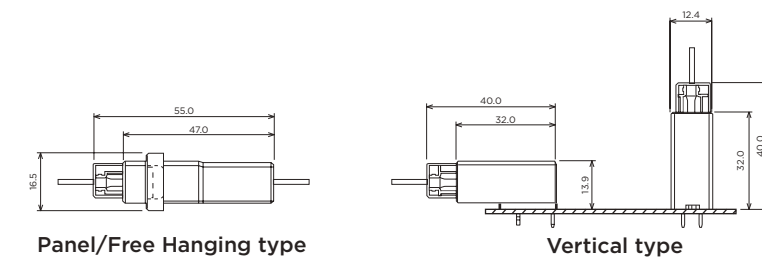

NOTE: All products are RoHS compliant On selection. You need to confirm LOT and lead time

D-5200S 1 Row High Current Type

External Dimension

- Receptacle Housing

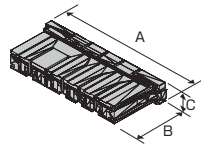

No. of Pos.	Keying	Plating	Color	Part Number	Dimensions		
					A	B	C
2	X	-	Black	1-179958-2	35.8	29.0	9.8
	Y	-	Black	2-179958-2			
3	X	-	Black	1-179958-3	46.0	29.0	9.8
	Y	-	Black	2-179958-3			
4	X	-	Black	1-179958-4	53.7	29.0	9.8
	Y	-	Black	2-179958-4			
6	X	-	Black	1-179958-6	74.0	29.0	9.8
	Y	-	Black	2-179958-6			

- Tab Housing
Panel type

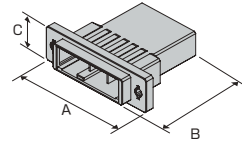

No. of Pos.	Keying	Plating	Color	Part Number	Dimensions		
					A	B	C
2	X	-	Black	1-353047-2	47.0	47.0	16.5
	Y	-	Black	2-353047-2			
3	X	-	Black	1-353047-3	57.0	47.0	16.5
	Y	-	Black	2-353047-3			

- Tab Housing
Free Hanging type

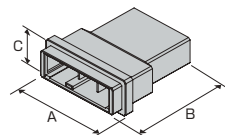

No. of Pos.	Keying	Plating	Color	Part Number	Dimensions		
					A	B	C
2	X	-	Black	1-353046-2	33.4	47.0	16.5
	Y	-	Black	2-353046-2			
3	X	-	Black	1-353046-3	43.6	47.0	16.5
	Y	-	Black	2-353046-3			

- PCB Mounting Tab Header
Horizontal type

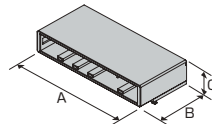

No. of Pos.	Keying	Plating	Color	Part Number	Dimensions		
					A	B	C
2	X	Gold	Black	1-353079-2	29.4	32.0	13.9
		Gold	Black	1-353079-3			
3	X	Gold	Black	1-353081-2	39.5	32.0	13.9
		Gold	Black	8-353081-2			
		Gold	Black	1-353081-3			
		Gold	Black	2-353081-2			
4	X	Gold	Black	1-917541-2	49.7	32.0	13.9
		Gold	Black	8-917541-2			
		Gold	Black	1-917541-3			
		Gold	Black	2-917541-2			
6	X	Gold	Black	1-179959-2	70.0	32.0	13.9
		Gold	Black	1-179959-3			
		Gold	Black	2-179959-2			
		Gold	Black	2-179959-3			

- PCB Mounting Tab Header
Vertical type

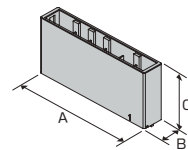

No. of Pos.	Keying	Plating	Color	Part Number	Dimensions		
					A	B	C
2	X	Gold	Black	1-353080-2	29.4	12.4	32.0
		Gold	Black	1-353080-3			
		Gold	Black	6-353080-2			
		Gold	Black	2-353080-2			
3	X	Gold	Black	1-353082-2	39.5	12.4	32.0
		Gold	Black	8-353082-2			
		Gold	Black	1-353082-3			
		Gold	Black	2-353082-2			
4	X	Gold	Black	1-917542-2	49.7	12.4	32.0
		Gold	Black	8-917542-2			
		Gold	Black	1-917542-3			
		Gold	Black	2-917542-2			
6	X	Gold	Black	1-179960-2	70.0	12.4	32.0
		Gold	Black	1-179960-3			
		Gold	Black	6-179960-2			
	Y	Gold	Black	2-179960-2			
		Gold	Black	2-179960-3			
		Gold	Black	7-179960-2			

NOTE: All products are RoHS compliant On selection. You need to confirm LOT and lead time

D-5200M 2 Row High Current Modular Type

Part Number Chart

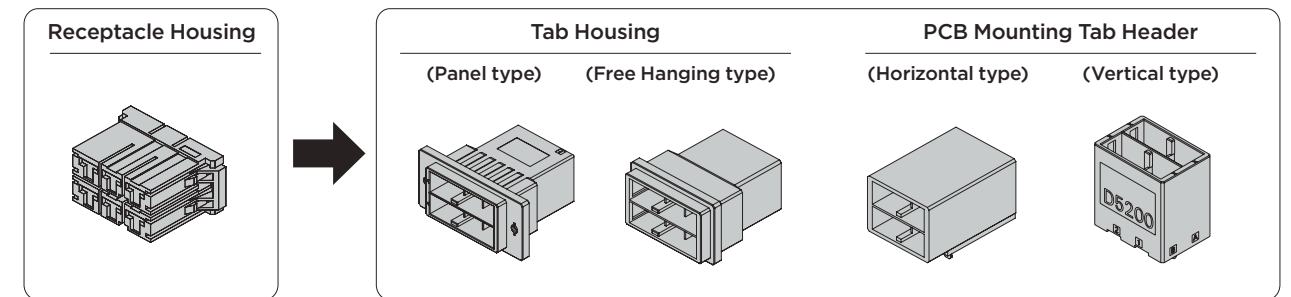

No. of Pos.	Color	Key	Receptacle Housing	Plating	Tab Housing		PCB Mounting Tab Header			
					Panel type	Free Hanging type	Horizontal type		Vertical type	
							Standard type	Sequential type	Standard type	Sequential type
4	Black	XX	1-917807-2	Gold/Silver	1-917809-2	1-917808-2	1-1123309-2	8-1123309-2	1-1981458-6	-
	Black	YY	2-917807-2	Gold/Silver	2-917809-2	2-917808-2	2-1123309-2	-	2-1981458-6	-
	Black	XY	3-917807-2	Gold/Silver	3-917809-2	3-917808-2	3-1123309-2	-	3-1981458-6	-
6	Black	XX	1-917807-3	-	1-917809-3	1-917808-3	-	-	-	-
	Black	YY	2-917807-3	-	2-917809-3	2-917808-3	-	-	-	-
	Black	XY	3-917807-3	-	3-917809-3	3-917808-3	-	-	-	-
8	Black	XX	-※1	Gold	-	-	1123829-1	-	-	-
	Black	YY	-	-	-	-	-	-	-	-
	Black	XY	-	-	-	-	-	-	-	-

* Use two of 1-179958-4

Related product information

Application Contact ...P.72
Performance • Specifications ...P.70

Mating Dimension

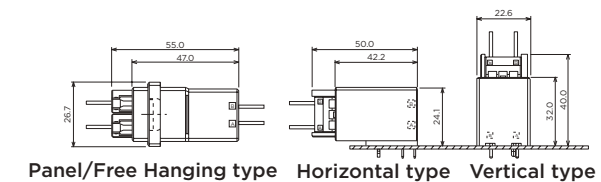

NOTE: All products are RoHS compliant On selection. You need to confirm LOT and lead time

D-5200M 2 Row High Current Modular Type

External Dimension

- Receptacle Housing

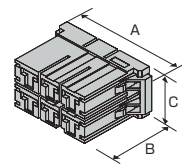

No. of Pos.	Keying	Plating	Color	Part Number	Dimensions		
					A	B	C
4	XX	-	Black	1-917807-2	33.4	29.0	20.0
	YY	-	Black	2-917807-2			
	XY	-	Black	3-917807-2			
6	XX	-	Black	1-917807-3	43.5	29.0	20.0
	YY	-	Black	2-917807-3			
	XY	-	Black	3-917807-3			

- Tab Housing
- Panel type

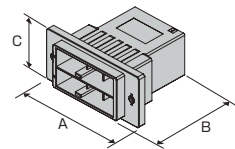

No. of Pos.	Keying	Plating	Color	Part Number	Dimensions		
					A	B	C
4	XX	-	Black	1-917809-2	47.0	47.0	26.7
	YY	-	Black	2-917809-2			
	XY	-	Black	3-917809-2			
6	XX	-	Black	1-917809-3	57.0	47.0	26.7
	YY	-	Black	2-917809-3			
	XY	-	Black	3-917809-3			

- Free Hanging type

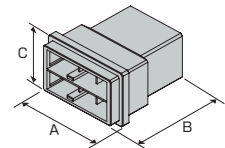

No. of Pos.	Keying	Plating	Color	Part Number	Dimensions		
					A	B	C
4	XX	-	Black	1-917808-2	33.4	47.0	26.7
	YY	-	Black	2-917808-2			
	XY	-	Black	3-917808-2			
6	XX	-	Black	1-917808-3	43.6	47.0	26.7
	YY	-	Black	2-917808-3			
	XY	-	Black	3-917808-3			

- PCB Mounting Tab Header
- Horizontal type

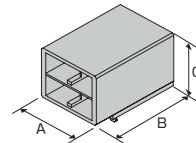

No. of Pos.	Keying	Plating	Color	Part Number	Dimensions		
					A	B	C
4	XX	Gold	Black	1-1123309-2	29.4	42.2	24.1
	YY	Gold	Black	2-1123309-2			
	XY	Gold	Black	3-1123309-2			
8	XX	Gold	Black	1123829-1	49.7	32.0	26.3

- Sequential type

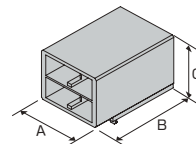

No. of Pos.	Keying	Plating	Color	Part Number	Dimensions		
					A	B	C
4	XX	Gold	Black	8-1123309-2	29.4	42.2	24.1

- Vertical type

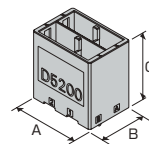

No. of Pos.	Keying	Plating	Color	Part Number	Dimensions		
					A	B	C
4	XX	Silver	Black	1-1981458-6	29.4	22.6	32.0
	YY	Silver	Black	2-1981458-6			
	XY	Silver	Black	3-1981458-6			

NOTE: All products are RoHS compliant On selection. You need to confirm LOT and lead time

D-5300 Reverse Mount Type

Part Number Chart

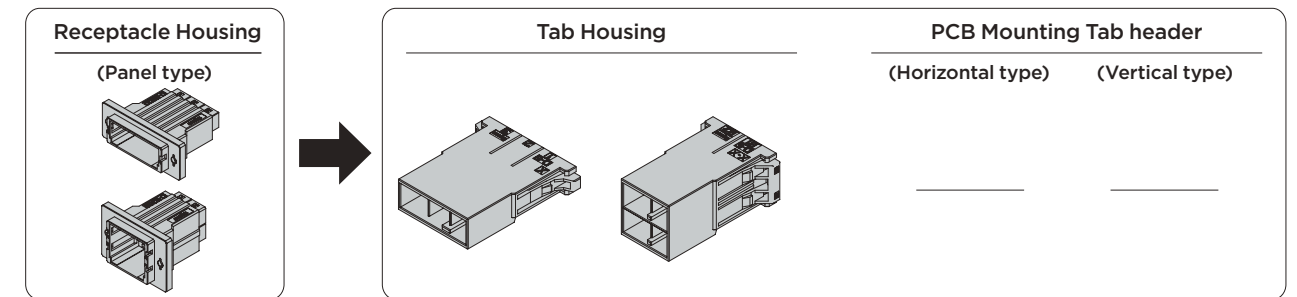

No. of Pos.	Color	Key	Receptacle Housing		Plating	Tab Housing	PCB Mounting Tab Header	
			Panel type				Horizontal type	Vertical type
3	Black	X	1-1747821-3	-	-	1-1747819-3	-	-
	Black	Y	2-1747821-3	-	-	2-1747819-3	-	-
4	Black	XX	1-1747822-2	-	-	1-1747820-2	-	-
	Black	YY	2-1747822-2	-	-	2-1747820-2	-	-
	Black	XY	3-1747822-2	-	-	3-1747820-2	-	-
	Natural	XX	1-2069332-1	-	-	1-2069331-1	-	-
	Yellow	XY	3-2069332-2	-	-	3-2069331-2	-	-
	Blue	YY	2-2069332-3	-	-	2-2069331-3	-	-

Related product information

Application Contact ...P.72
Performance • Specifications ...P.70

Mating Dimension

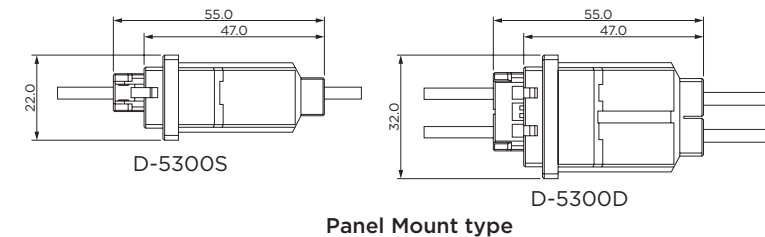

External Dimension

- Receptacle Housing
- Panel Mount type

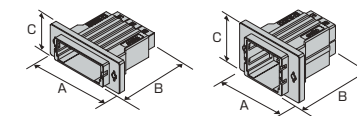

No. of Pos.	Keying	Plating	Color	Part Number	Dimensions		
					A	B	C
3	X	-	Black	1-1747821-3	57.0	47.0	22.0
	Y	-	Black	2-1747821-3			
4	XX	-	Black	1-1747822-2	47.0	47.0	32.0
	YY	-	Black	2-1747822-2			
	XY	-	Black	3-1747822-2			
	XX	-	Natural	1-2069332-1			
	XY	-	Yellow	3-2069332-2			
	XY	-	Blue	2-2069332-3			

NOTE: All products are RoHS compliant On selection. You need to confirm LOT and lead time

- Tab Housing

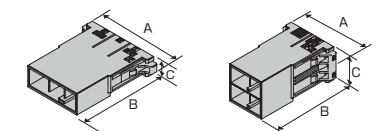

No. of Pos.	Keying	Plating	Color	Part Number	Dimensions		
					A	B	C
3	X	-	Black	1-1747819-3	46.5	47.0	12.5
	Y	-	Black	2-1747819-3			
4	XX	-	Black	1-1747820-2	33.8	47.0	22.6
	YY	-	Black	2-1747820-2			
	XY	-	Black	3-1747820-2			
	XX	-	Natural	1-2069331-1			
	XY	-	Yellow	3-2069331-2			
	YY	-	Blue	2-2069331-3			

D-5200 Dyna-Tap 12P (4Px3 Row), 20P (5Px4 Row)

Part Number Chart

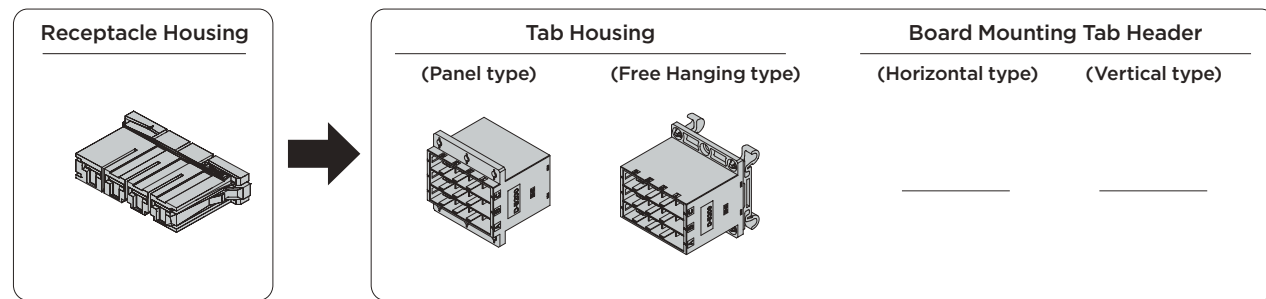

No of Pos.	Color	Key	Receptacle Housing	Plating	Tab Housing		PCB Mounting Tab Header	
					Panel & Din Rail Type	Free Hanging type	Horizontal type	Vertical type
4	Black	-	1-179958-4	-	-	-	-	-
12	Black	-	-	Gold	1903146-1*1	1903146-3	-	-
12	Black	-	-	Gold	1903146-2*2	1-1903146-3	-	-
20	Black	-	-	Gold	2013285-1	-	-	-
	Black	-	-	Gold	2013285-2*2	2013285-3	-	-

*1: front panel type *2: bottom panel type

Mating Dimension

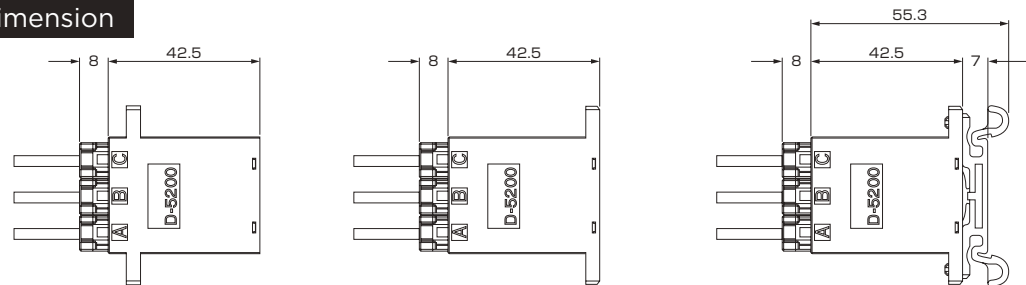

Mating Dimension
Receptacle Housing

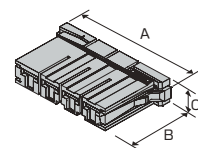

No.of Pos.	Keying	Plating	Color	Part Number	Dimensions		
					A	B	C
4	-	-	Black	1-179958-4	53.7	29.0	9.8

Tab Housing
Panel type

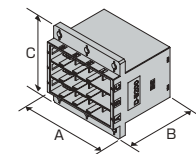

No.of Pos.	Keying	Plating	Color	Part Number	Dimensions		
					A	B	C
12	-	Gold	Black	1903146-1	49.7	42.5	50.0
	-	Gold	Black	1903146-2			
20	-	Gold	Black	2013285-1	50.5	42.5	76.4
	-	Gold	Black	2013285-2			

DIN Rail type

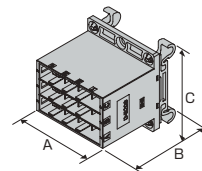

No.of Pos.	Keying	Plating	Color	Part Number	Dimensions		
					A	B	C
12	-	Gold	Black	1903146-3	49.7	55.3	50.0
	-	Gold	Black	1-1903146-3			
20	-	Gold	Black	2013285-3	53.0	55.3	76.4

NOTE: All products are RoHS compliant On selection. You need to confirm LOT and lead time

Dyna-Clamp Kit/Cable Clamp Kit

Part Number Chart

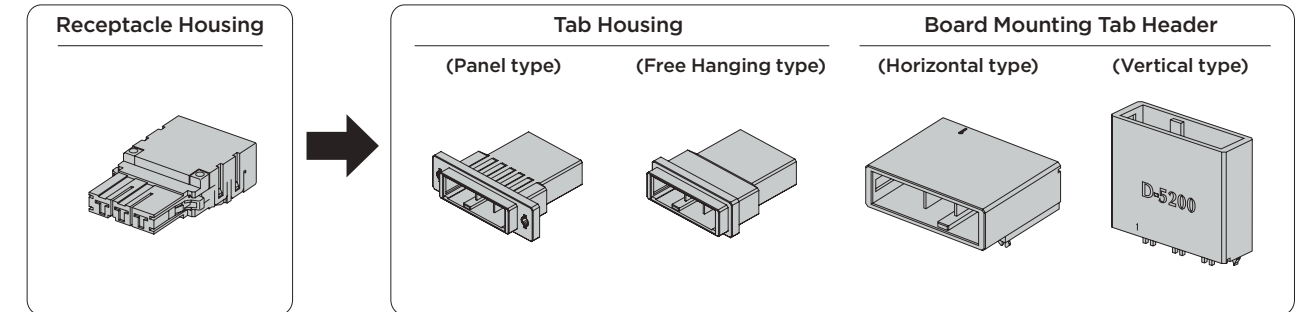

No. of Pos	Key	Cable Clamp	Tab Housing		PCB Mounted Tab Header	
			Panel type	Free Hanging type	Horizontal type	Vertical type
3	-	1473668-1	1-353047-3	1-353046-3	1-353081-2 1-353081-3	1-353082-2 1-353082-3

Mating Dimension

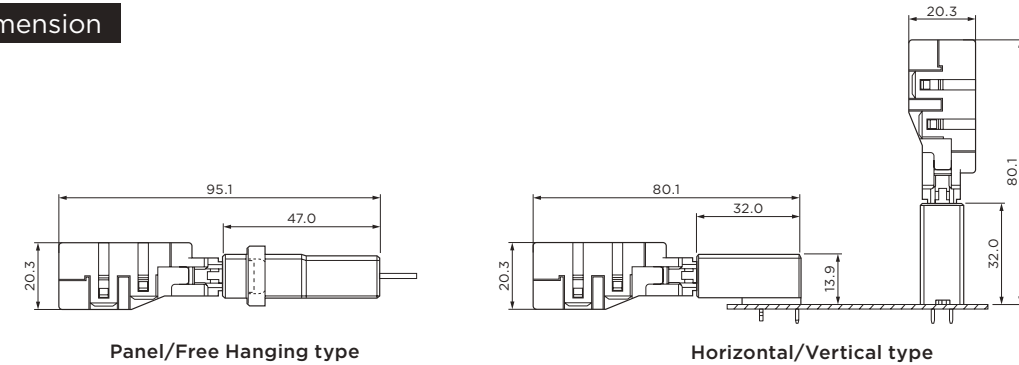

External Dimension

Cable Clamp

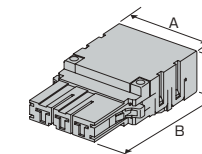

No.of Pos.	Keying	Plating	Color	Part Number	Dimensions		
					A	B	C
3	-	-	Black	1473668-1	40.3	69.3	20.3

NOTE: All products are RoHS compliant On selection. You need to confirm LOT and lead time

Dyna-Clamp Kit/Cable Clamp Kit

• Tab Housing
Panel type C

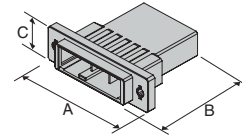

No.of Pos.	Keying	Plating	Color	Part Number	Dimensions		
					A	B	C
3	X	-	Black	1-353047-3	57.0	47.0	12.1

• Tab Housing
Free Hanging type C

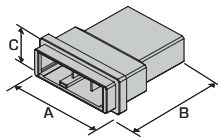

No.of Pos.	Keying	Plating	Color	Part Number	Dimensions		
					A	B	C
3	X	-	Black	1-353046-3	43.6	47.0	12.1

• Board Mounting Tab Header
Horizontal type

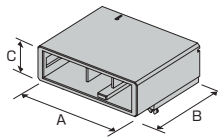

No.of Pos.	Keying	Plating	Color	Part Number	Dimensions		
					A	B	C
3	X	Gold	Black	1-353081-2	39.5	32.0	13.9
		Gold	Black	1-353081-3			

Vertical type

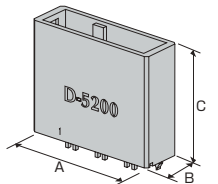

No.of Pos.	Keying	Plating	Color	Part Number	Dimensions		
					A	B	C
3	X	Gold	Black	1-353082-2	39.5	12.4	32.0
		Gold	Black	1-353082-3			

NOTE: All products are RoHS compliant On selection. You need to confirm LOT and lead time

D-5000α Series Contact

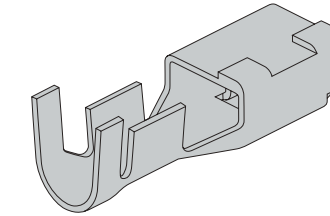

• D-5α Series silver plate type

Applicable Wiring Range		Insulated Wire mm	Wire Range Mark	Contact Part Number			Applicable Tool Product Number			
				Receptacle Contact		Tab Contact	Hand Tool	Electric Hydraulic type Tool*5	Dice*6	Mini Applicator
AWG	mm ²	Strip Form	Loose Piece	Loose Piece						
20	0.50	1.8-2.83	SS	1318985-6	1318986-6	-	91596-1	-	-	1366757-2 1528106-2
16	1.25	2.35-3.23		179955-6	316040-6	917804-6	234170-1	2155822-1	1366659-2 1426229-2*1	
16	1.25	3-3.80	S	179956-6	316041-6	917805-6	234171-1	2155369-1	2155503-1	1366660-2*2 2151086-2*3
14	2.20									
12	3.50	4-5.2	M	131896-6	1318697-6	1747443-6	1366044-1		2155502-1	1366658-3 1426325-2*4
10	5.50							L		

Note: model number '-6' for plating means 2.54 μm silver plating
When placing your order, please check with the confirmed sale slots.
Please contact our sales department or purchase distributor for more information.

For mini applicator, please contact our sales department
The connected contact is for use with mini applicator (bench machine), the loose contact is for use with hand tools

- applicable terminal : 179955- □
- applicable terminal : 179956- □ 917803- □ 84695- □
- applicable terminal : 179956- □ 917803- □
- applicable terminal : 1318696- □
- for more information please refer to P.109
If you have any questions please contact AT tooling Sales Department (044 - 900 - 5027)
- electro-hydraulic tool with 2155369 -1

Receptacle contacts can be used in all housings.

NOTE: All products are RoHS compliant On selection. You need to confirm LOT and lead time

D-5200Mα 2 Row High Current/Voltage Modular Type

Part Number Chart

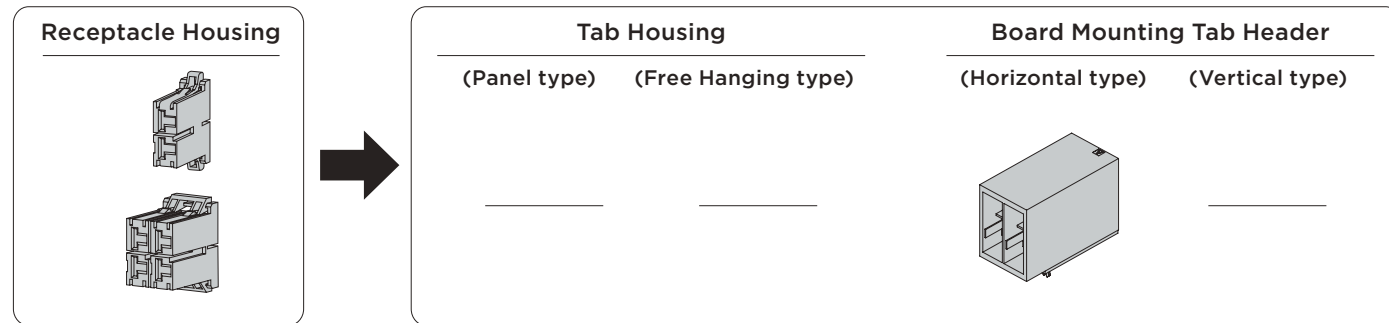

No of Pos.	Color	Key	Receptacle Housing	Plating	Tab Housing		PCB Mounting Tab Header	
					Panel type	Free Hanging type	Horizontal type	Vertical type
2	Black	X	1-179958-2	-	-	-	-	-
	Black	Y	2-179958-2	-	-	-	-	-
4	Black	XX	1-917807-2	Silver	-	-	1-1318983-6	-
	Black	YY	2-917807-2	Silver	-	-	2-1318983-6	-
	Black	XY	3-917807-2	Silver	-	-	3-1318983-6	-

Note: Receptacle housing 2-pole D-5200S and 4-pole D-5200M are the same product
However, contact used is D-5α(silver plating • type)

Related product information

Application Contact ...P.81
Performance • Specifications ...P.70

Mating Dimension

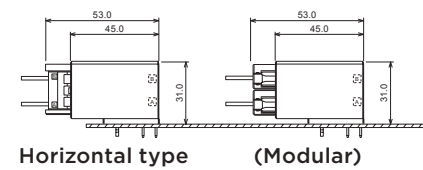

External Dimension

- Receptacle Housing

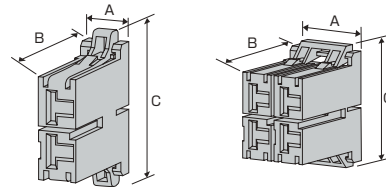

No. of Pos.	Keying	Plating	Color	Part Number	Dimensions		
					A	B	C
2	X	-	Black	1-179958-2	9.8	29.0	23.8
	Y	-	Black	2-179958-2			
4	XX	-	Black	1-917807-2	20.0	29.0	33.4
	YY	-	Black	2-917807-2			
	XY	-	Black	3-917807-2			

- PCB Mounting Tab Header
Horizontal type

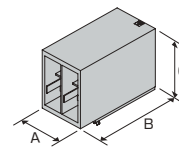

No. of Pos.	Keying	Plating	Color	Part Number	Dimensions		
					A	B	C
4	XX	Silver	Black	1-1318983-6	22.6	45.0	30.9
	YY	Silver	Black	2-1318983-6			
	XY	Silver	Black	3-1318983-6			

NOTE: All products are RoHS compliant On selection.
You need to confirm LOT and lead time

D-5900 - Spring Clamp

D-5900 Spring Clamp

- Receptacle Assembly



- Board Mount Header Assembly

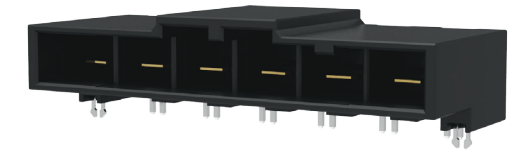

5900 Spring Clamp Parts List					
No of Pos.	Color	Key	Receptacle Assembly	Plating	Board-Mounting Header Assembly (Horizontal Type)
4	Black	X	4-2260663-1	Gold	4-2260661-1
		Y	4-2260663-2		4-2260661-2
6	Black	X	6-2260663-1		6-2260661-1
		Y	6-2260663-2		6-2260661-2

- Spring Opener Tool



Part Number	Description
2260828-1	DYNAMIC D5900 OPENER

DZ-5200

- Useful for enabling cableless control board. High-current board to board connectors with 30A per contact.
- Equipped with retention leg to protect board from load
 - Space allocated to prevent twisting the contact
 - Circuit numbers are easy to identify even for board connectors
 - Keying function included for flexibility when using multiple units
 - Soldering without masking

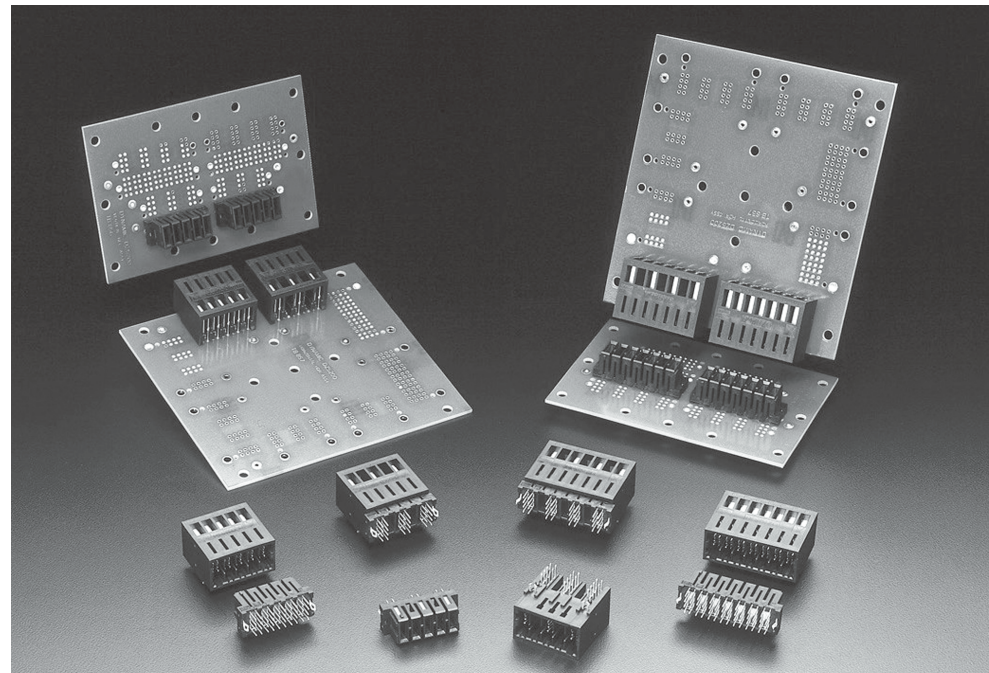

Performance Specifications

Item	Pitch	200 mils/400 mils 5.08mm/10.16mm
Voltage Rating		5.08mm Pitch : 250V AC (RMS)/DC 10.16mm Pitch : 600V AC (RMS)/DC
Current Rating		5.08mm Pitch : 20A 10.16mm Pitch : 30A
Contact Resistance		2mΩmax
Dielectric Withstanding Voltage		5.08mm Pitch : 2,200V AC 1minute 10.16mm Pitch : 4,000V AC 1minute
Operating Temperature		-55-+105°C
Product Standards		108-78186

Material and Completion

Category	Material	Completion
Receptacle Contact Tab Contact	Phosphorous Bronze Copper Alloy	Gold Plate (contact parts) Nickel Undercoat Gold Plate
Tab Post	Phosphorous Bronze	Tin Plate or (contact parts) Gold Plate Nickel Undercoat Gold Plate
Housing	UL94V-0, Glass-Reinforced Thermoplastic PBT	

DZ-5200

Part Number Chart

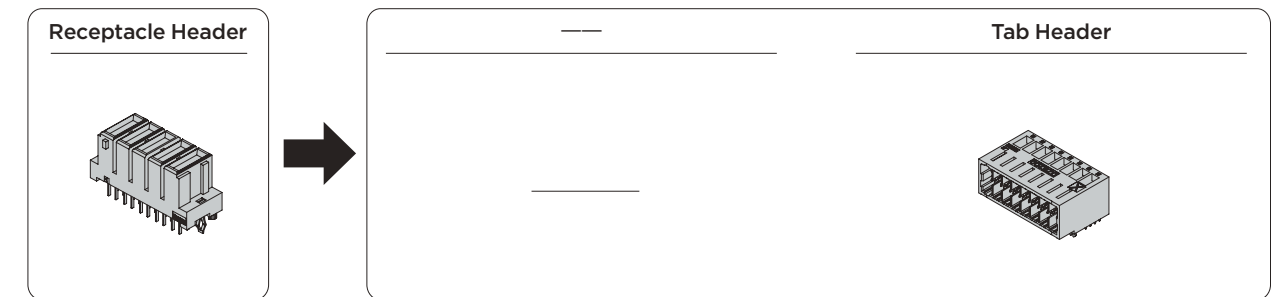

No.of Pos.	Color	Keying	Receptacle Header	Plating	-	Tab Header
3	Black	-	5-1747147-3	Gold	-	5-1747145-3
4	Black	-	5-1747147-4	Gold	-	5-1747145-4
5	Black	-	1-1747147-5	Gold	-	1-1747145-5
7	Black	-	1-1747147-7	Gold	-	1-1747145-7

External Dimension

- Receptacle Header

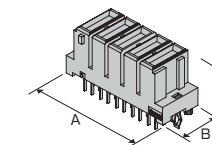

No.of Pos.	Keying	Plating	Color	Part Number	Dimensions		
					A	B	C
3	-	Gold	Black	5-1747147-3	30.8	11.5	14.0
4	-	Gold	Black	5-1747147-4	40.9	11.5	14.0
5	-	Gold	Black	1-1747147-5	30.8	11.5	14.0
7	-	Gold	Black	1-1747147-7	40.9	11.5	14.0

- Tab Header

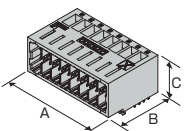

No.of Pos.	Keying	Plating	Color	Part Number	Dimensions		
					A	B	C
3	-	Gold	Black	5-1747145-3	28.8	27.0	17.5
4	-	Gold	Black	5-1747145-4	39.0	27.0	17.5
5	-	Gold	Black	1-1747145-5	28.8	27.0	17.5
7	-	Gold	Black	1-1747145-7	39.0	27.0	17.5

NOTE: All products are RoHS compliant On selection. You need to confirm LOT and lead time

Dynamic HTS Module

Dynamic connector developed for applications that need heavy duty waterproofing. Now it is possible to use Dynamic series connectors for everything inside and outside the control board.

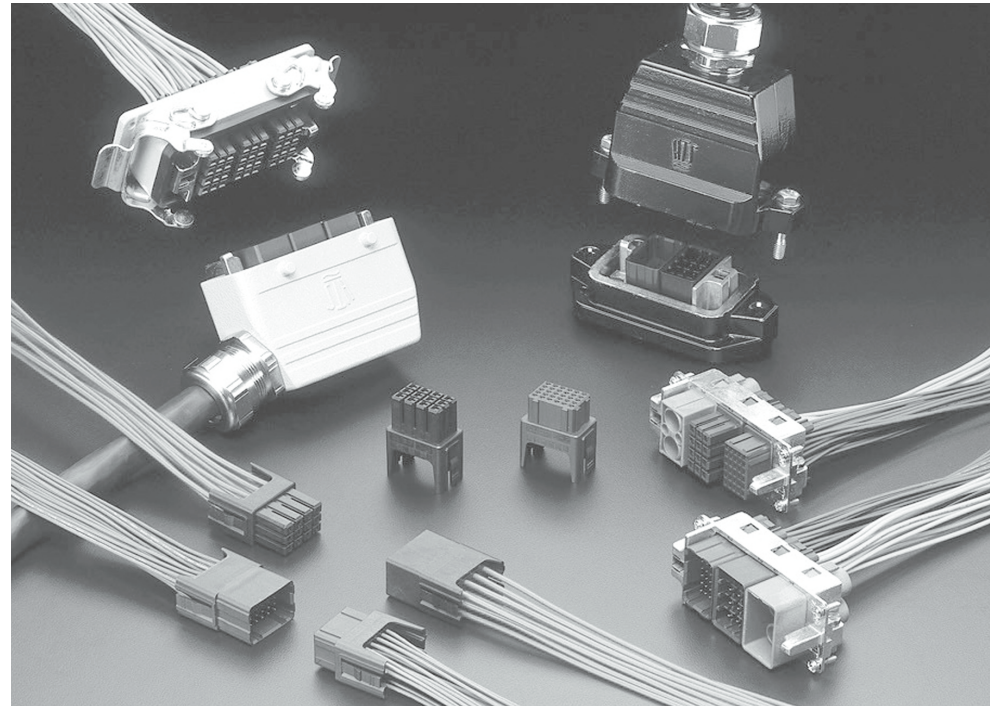

Performance Specifications

Item \ Pitch	D-2800	D-3800	D-4800	D-5800
Voltage Rating	250VAC/DC	600VAC/DC	600VAC/DC	630VAC/DC
Current Rating	5A	15A	25A	40A
	AWG#18 as powersource	AWG#16 as powersource	AWG#16 as powersource	AWG#16 as powersource
Contact Resistance	10mΩ max			2mΩ max
Dielectric Withstanding Voltage	1,500VAC (1 minute)		2,500VAC (1 minute)	3,000VAC (1 minute)
Operating Temperature	-55-+105°C			
Product Standards	108-78284	108-78285	108-78388	108-78389
Mounting Application Standard	114-5258	114-5148	114-5369	114-5206

Material and Completion

Category	Material	Completion
Receptacle Contact Tab Contact	Phosphorous Bronze Copper Alloy	Nickel Undercoat Gold Plating (0.38 μm)
Housing	UL94V-0, Glass-Reinforced Thermoplastic PBT	

Contact
Proven DYNAMIC Series D - 2 and D-3, D-4, D - 5 Contacts used special tools and applicators from existing products can be used interchangeably
D - 2 Contact please refer to P28. D - 4 Contact please refer to P65.
D - 3 Contact please refer to P38. D - 5 Contact please refer to P72.

Dynamic HTS Module

A collaboration between our own highly appraised Dynamic Series and the HTS series famed for its box connectors

Feature 1: Existing Dynamic Contacts can be used
Proven Dynamic Series contacts can be used without changing, so your existing special tools and applicators can be reused.

Feature 2
Depending on the combination, the wide variety of installation styles and sizes combined with the wide variety of HTS connector, metal hoods and frames, enable you to choose the number of poles freely.

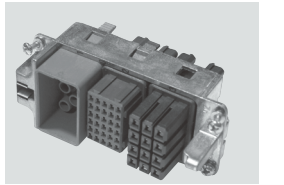

Using Dynamic Series with HTS

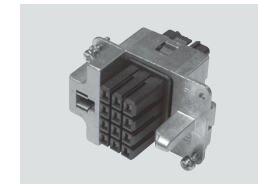

1 module type

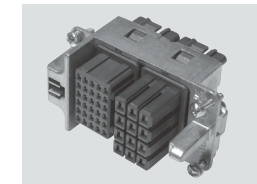

2 module type

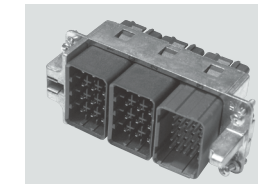

3 module type

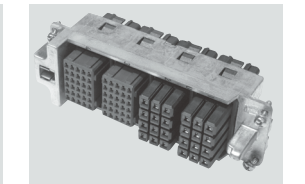

4 module type

Feature 3: Number of operations has been reduced
Cabling time is greatly reduced by introducing serial terminals which can take an automatic crimper.

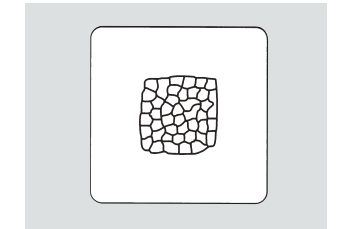

There is nothing more troublesome than poking a cable into a terminal hole for crimping

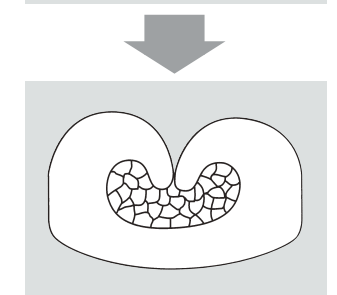

Lining up the cables for crimping makes life easy. Continuous terminals allow automatic crimping

Feature 4: Precise installation
Accuracy is improved by 30% even over the existing HTS high-accuracy type connector range

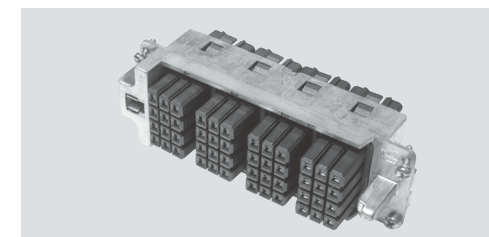

D-3000 4 module type 48 poles

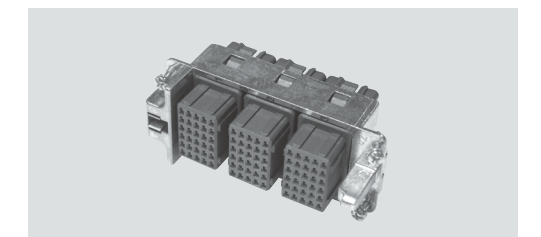

D-2000 3 module type 90 poles

Connector selection process

Step 1

Select Current Value,
Number of Poles

Step 2

Select Wire Size

Step 3

Select Contact,
Housing

Step 4

Frame Selection

Step 5

Select Cable Fit
(screw)

Step 6

Select Metal Housing

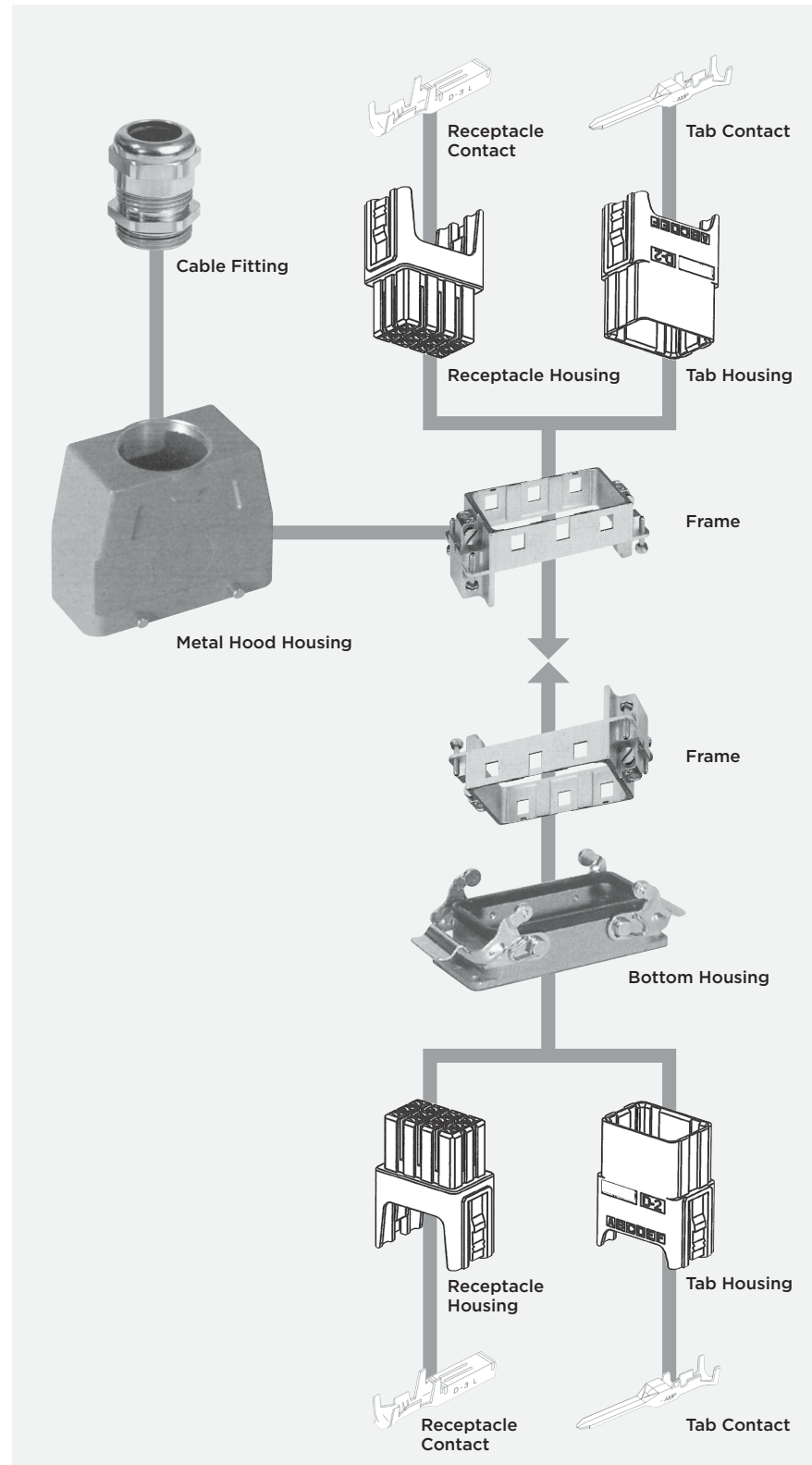

Connector selection examples

Step 1 Step 2

Please refer to the table below to
select number of poles and wire size
for the current value.

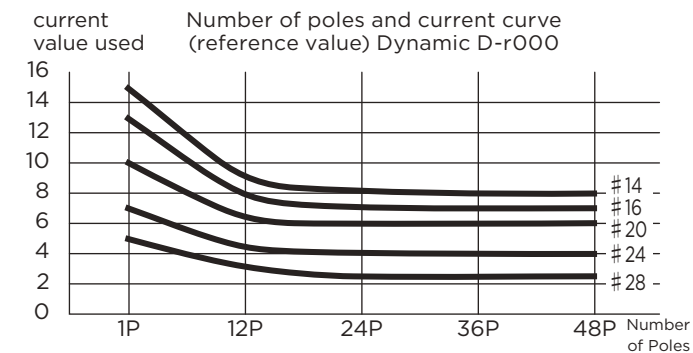
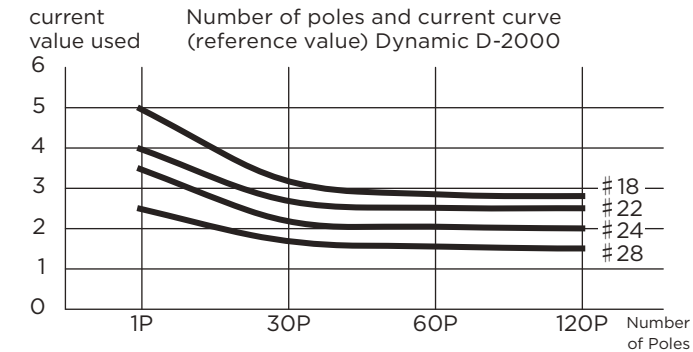

Connector selection example (1) shows the connector selection method supposing a current value of 8A on 20 poles and 3A on 20 poles. This example, the current curve example above shows that D-3000 using #16 meets the 8A 20 poles requirement, and D-2000 using #18 meets the 3A 20 poles requirement. (please refer to P 28 and P 38 for contacts)
D-2000 contact: 1318105-1, 1318109-1
D-3000 contact: 917484-□, 917485-□

Step 3 Step 4

To match the connectors, you can choose the Dynamic Housing with your own application. (see P.81, 82) and frame (see P.83).

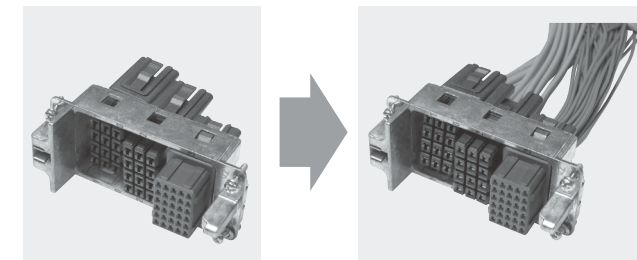

Connector example (2)
As illustrated from the specification of example (1), 2 sets of D-3000 housing is required, and 1 set of D-2000 housing (selected from P.89,90). As there are 3 sets of housing in total, the 3-module frame is required (selected from P.83).
D-2000 housings: 1747365-1, 1747366-1 (1 each)
D-3000 housings: 1747363-1, 1747364-1 (2 each)
3-module frame: 1108782-1, 1108782-2 (1 each)

Step 5

Please select the cable fitting for your jacket cable thickness (P 84).

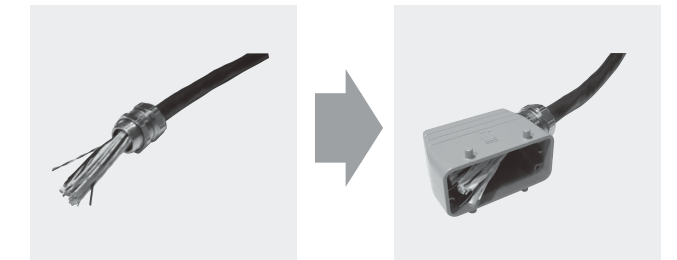

If a jacket cable diameter of 21mm is selected as on the above example, use the cable fitting applicable cable outer diameter chart (Dmin&Dmax) on page 84. In case it is a metal type, select PG29 or M32 cable fitting as the suitable model. An M32 type is selected in this example.
M32 cable fitting: 1 pc 3-1102770-2
Many cable fitting options are available. For options not available in P92 of the catalogue, please refer to HTS catalogue (889745 Rev. 01- 05).

Step 6

Finally, referring to HTS catalogue (889745-2 Rev. 09-06), please choose the metal matching the frame and cable fittings in size. There are a further 3 lock options for the metal type.
* When selecting the lock form, please ensure that the cable side and the housing side have the same lock format.

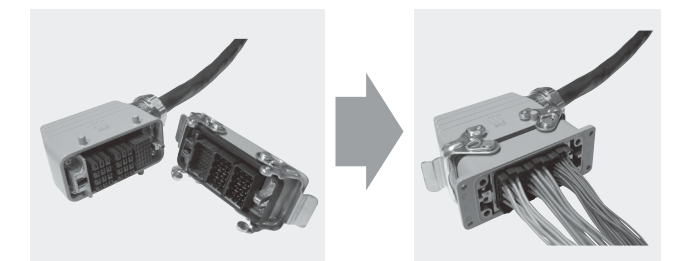

Connector selection example (4)
Selecting the suitable metal housing for the existing connector parts. With the M32 cable fitting mounted, the 3 module type (size 6) metal hood is selected from the HTS catalogue. In this example, the wiring takeoff direction is selected as both side locks of the horizontal type. In the same way, the bottom side metal housing is selected as both sides locks. Finally, load the existing parts into the metal housing to complete.
Metal Hood Housing : 1106449- 4
Metal Bottom Housing : 1-1102296-1

HTS Catalogue (889745-2 Rev.08-2011) has the details of the wide variety of metal housing types available. The HTS catalogue can be found on P.91 of this catalogue.

Dynamic HTS Module

Part Number Chart

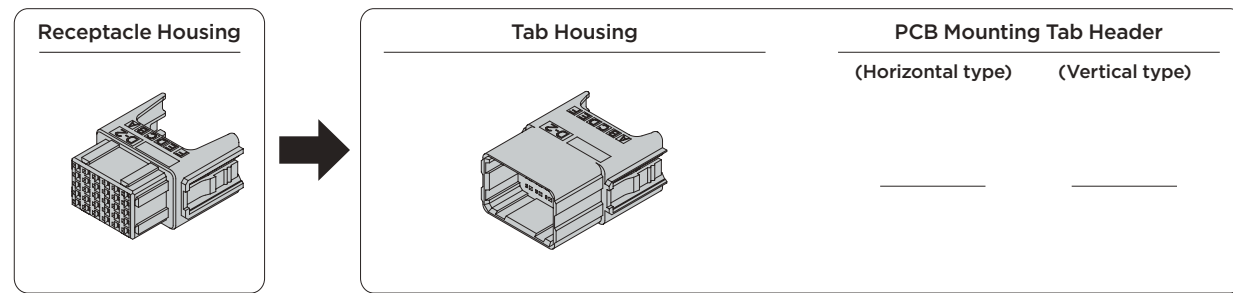

No. of Pos.	Color	Key	Receptacle Housing	Plating	Tab Housing	Board Mounting Tab Header	
						Horizontal type	Vertical type
30	Black	-	1747365-1	-	1747366-1	-	-
12	Black	-	1747363-1	-	1747364-1	-	-
8	Black	-	1871416-1	-	1871417-1	-	-
4	Black	-	1871418-1	-	1871419-1	-	-

D-2800

External Dimension

- Receptacle Housing

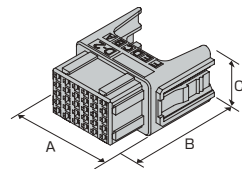

No. of Pos.	Keying	Plating	Color	Part Number	Dimensions		
					A	B	C
30	-	-	Black	1747365-1	30.3	37.6	19.5

- Tab Housing

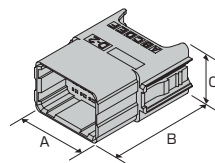

No. of Pos.	Keying	Plating	Color	Part Number	Dimensions		
					A	B	C
30	-	-	Black	1747366-1	30.3	40.0	19.5

NOTE: All products are RoHS compliant On selection. You need to confirm LOT and lead time

Dynamic HTS Module

D-3800

External Dimension

- Receptacle Housing

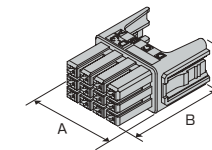

No. of Pos.	Keying	Plating	Color	Part Number	Dimensions		
					A	B	C
12	-	-	Black	1747363-1	30.3	41.4	19.5

- Tab Housing

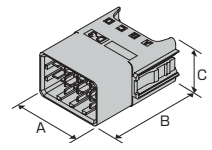

No. of Pos.	Keying	Plating	Color	Part Number	Dimensions		
					A	B	C
12	-	-	Black	1747364-1	30.3	40.0	19.5

D-4800

External Dimension

- Receptacle Housing

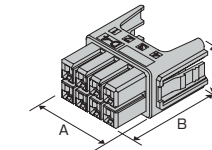

No. of Pos.	Keying	Plating	Color	Part Number	Dimensions		
					A	B	C
8	-	-	Black	1871416-1	30.3	38.6	19.5

- Tab Housing

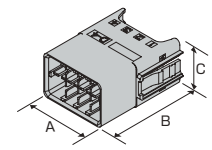

No. of Pos.	Keying	Plating	Color	Part Number	Dimensions		
					A	B	C
8	-	-	Black	1871417-1	30.3	40.0	19.5

D-5800

External Dimension

- Receptacle Housing

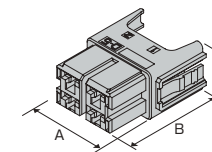

No. of Pos.	Keying	Plating	Color	Part Number	Dimensions		
					A	B	C
4	-	-	Black	1871418-1	30.3	41.4	19.5

- Tab Housing

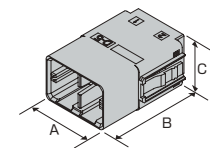

No. of Pos.	Keying	Plating	Color	Part Number	Dimensions		
					A	B	C
4	-	-	Black	1871419-1	30.3	44.1	19.5

NOTE: All products are RoHS compliant On selection. You need to confirm LOT and lead time

Dynamic HTS Module

Frame

Metal Hood Housing

See HTS Catalogue 889745-2 Rev.08-2011

Size 3 (1 module type)

Model : 1108784-1
male and female

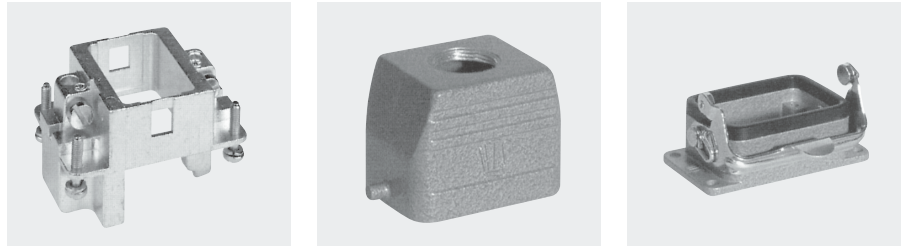

See HTS catalogue P.72 to P.74

Size 4 (2 module type)

Model : 11108783-1 (male)
1108783-2(female)

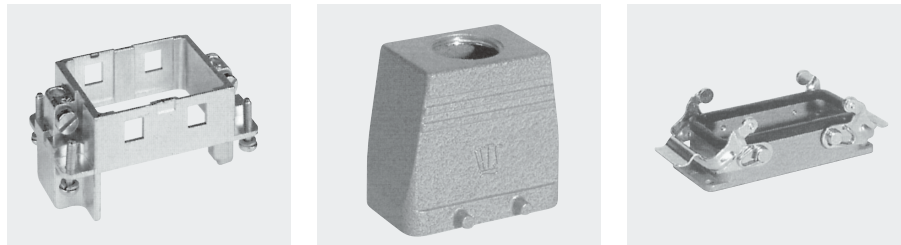

See HTS catalogue P.86 to P.88

Size 6 (3 module type)

Model : 11108782-1 (male)
1108782-2 (female)

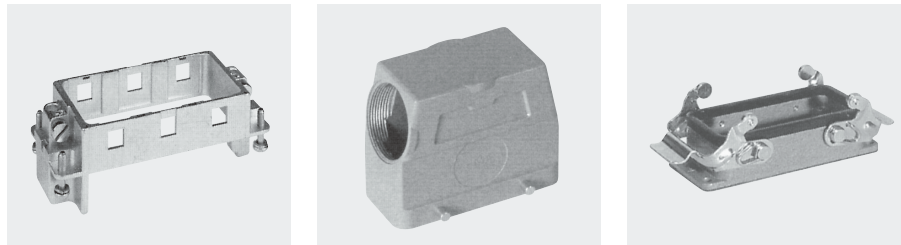

See HTS Catalogue: P.114 to P.116

Size 8 (4 module type)

Model : 1108780-1 (male)
1108780-2 (female)



See HTS catalogue P.138 to P.140

NOTE: All products are RoHS compliant On selection.
You need to confirm LOT and lead time

Dynamic Multipole Frame

Product Introduction

Dynamic series connector modular type housing is held in a plastic frame, allowing simple one-stage insertion and withdrawal. Modular housings of the existing D-2800, 3800, 4800, and 5800 series can be freely inserted in the frame. Also, our unique lock will lock itself on insertion, and needs only finger pressure to unlock for withdrawal, making it easier for the assembler. This frame system greatly reduces the number of operations needed in installation and maintenance, saving time and avoiding mistakes.

Product Features

- * Modular structure of the dynamic series housing
- * Panel (Housing) mounted
- * One-touch lock* Lever for easy unlocking
- * Misinsertion prevention structure
- * Increase productivity

Application

- * Semiconductor and LCD manufacturing equipment
- * Large-scale control equipment and machine tools
- * Others

Mating Dimension

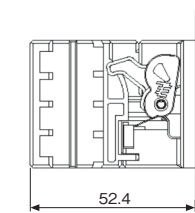

Outside Dimension

- Cable Side Frame

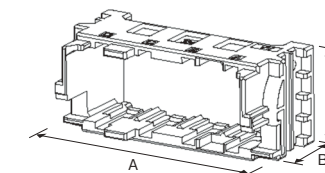

- Panel Side Frame

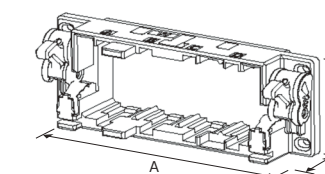

Product Standards

Product Standard number 108-78268
Mounting Applied Standard 114-5377

Product Specification

Product Standard for other items number 108-78644 (Please refer to the standard)

Item	Standard
Frame Lock Strength	Tensile: 15kgf minimum
Durability	Maximum 50 times

Keying	Part Number	Dimension (mm)		
		A	B	C
W	2069524-1	97.1	45.1	40.4

Keying	Part Number	Dimension (mm)		
		A	B	C
W	2069526-1	120.0	34.3	40.4

Dynamic HTS Module

Cable Fitting

Plastic type

Grand fitting IP 68 plastic

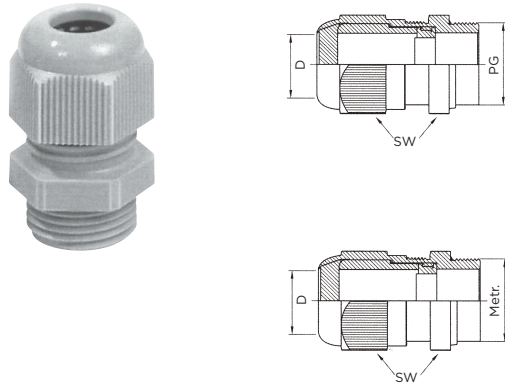

PG	Dimension D		SW	Designation	Part Number
	Minimum	Maximum			
11	5	10	22	HUT.11.P	1-1106005-7
13.5	6	12	24	HUT.13.P	2-1106005-7
16	10	14	27	HUT.16.P	3-1106005-7
21	13	18	33	HUT.21.P	4-1106005-7
29	18	25	42	HUT.29.P	5-1106005-7

Metr.	Dimension D		SW	Designation	Part Number
	Minimum	Maximum			
M16	4	8	20	HUT.M16.P	1-1102771-6
M20	6	12	24	HUT.M20.P	2-1102771-0
M25	10	14	29	HUT.M25.P	2-1102771-5
M32	13	18	36	HUT.M32.P	3-1102771-2
M40	18	25	46	HUT.M40.P	4-1102771-0
M50	22	32	55	HUT.M50.P	5-1102771-0

Metal type

Ground fitting IP68 neoprene sealing insert or ring with a nickel plated brass connection screw

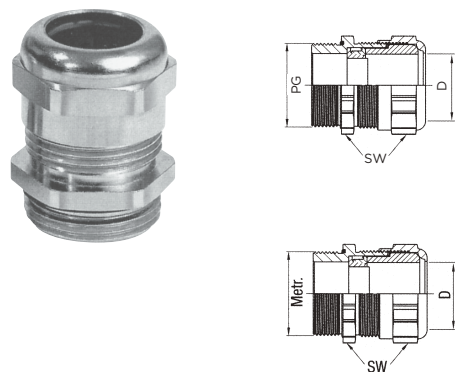

PG	Dimension D		SW	Designation	Part Number
	Minimum	Maximum			
11	5	10	20	HUT.11.MS	1-1106006-9
13.5	6	12	22	HUT.13.MS	2-1106006-9
16	10	14	24	HUT.16.MS	3-1106006-9
21	13	18	30	HUT.21.MS	4-1106006-9
29	18	25	40	HUT.29.MS	5-1106006-9
36	22	32	50	HUT.36.MS	6-1106006-9
42	32	38	57	HUT.42.MS	7-1106006-9

Metr.	Dimension D		SW	Designation	Part Number
	Minimum	Maximum			
M16	5	10	17	HUT.M16.MS	1-1102770-6
M20	6	12	22	HUT.M20.MS	2-1102770-0
M25	13	18	27	HUT.M25.MS	2-1102770-5
M32	18	25	34	HUT.M32.MS	3-1102770-2
M40	22	32	43	HUT.M40.MS	4-1102770-0

There are also many other options available. Please refer to P.188-193 of the HTS Catalogue for more information.

D-7000 Series

Series Introduction

The lineup of the Dynamic D7000 series includes the highest power rated connector in the series at max 65A (per contact, using max. wire size) It is available in board to wire, wire to wire, wire to panel - some are finger safe (Reverse Mount Type) - and long pin all providing stable electrical connections for semiconductor manufacturing machines, construction plant etc. The number of positions is the industry standard 4P, which will meet a wide range of application requirements. The receptive contact is the 'crown band' type containing a tube shape spring, meaning high current and smooth operation, offering performance with ease of use.

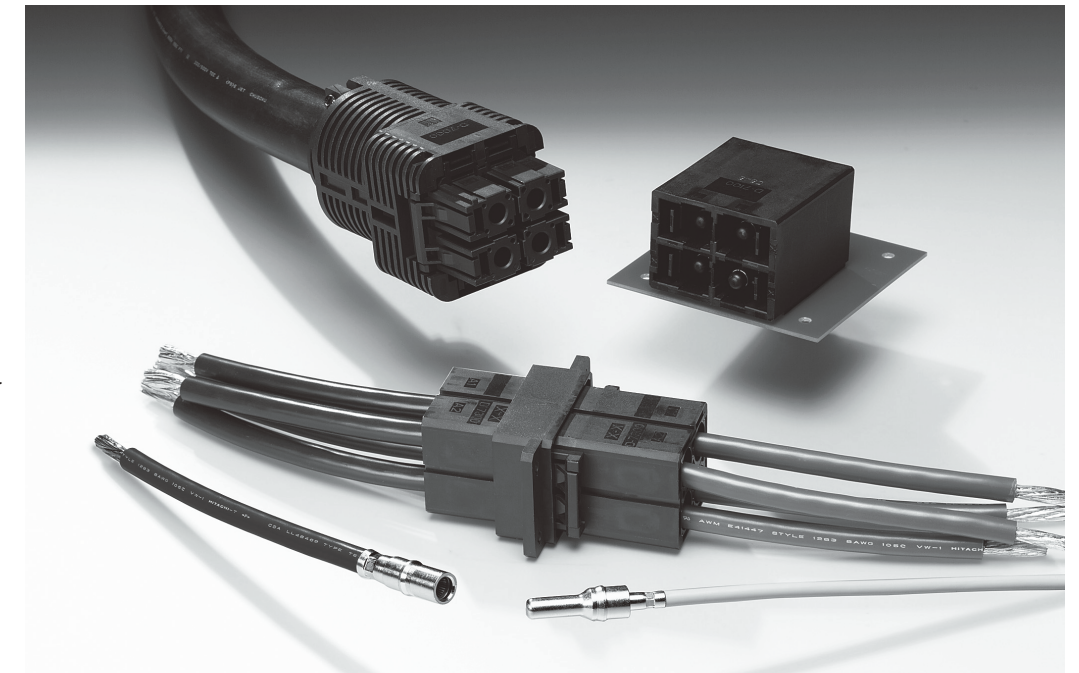

Product Features

- Achieved High Current and High Reliability up to 65A
To accommodate the high current of 65A, we adopted, for the first time, a crown band with a multi-point contact mechanism in the receptacle contact. This contact is not only highly reliable, but disperses the heat generated when high current passes through the contact.
- Protection class IP20 provided
By using a new concept cap for the terminal part, IP20 finger protection is realized. This makes it ideal for power safety in industrial equipment such as semiconductor manufacturing machines, large control equipment, or construction plant.
- Sequential connection is compatible
2 types of pin contact are available, standard type and long type. This is ideal for applications when sequential connections from the crown pin are required.
- Other
* Standard type and reverse type are available, offering a wide variety of mating options
* By using cable clamp type applicable to jacket cable, it can be used as an I/O connector

D-7000 Series Performance Specifications Standards

Performance Specifications/Wire Size/Current Rating

Item	
Pitch	16mm
Current Rating	65A max
Voltage Rating	630V AC/DC
Dielectric Withstanding voltage	3000VAC
Total Resistance	2mΩ max
Insertion Strength	9.8N max (per pole)
Withdrawal Strength	1.96N min (per pole)
Durability	20 times (gold 0.76 μm/hour)
Lock Strength	196Nmin

Pos. Number/Wire Size/Current Rating

Units: A (Amps).

No. of Pos.	Series	Wire Size(AWG)					
		14	12	10	8	6	
4	Board-to-wire	18	23	31	35	50	60
4	Wire-to-wire	-	-	31	35	55	65
4	(wire to wire cable clamp type)	-	-	25	35	45	55

Performance Specifications

Product Standards	108-78470
Test Report	501-78004
Mounting Application Standard	114-5452

Please order the manual concurrently. An e Catalogue is also available for download from the internet.

Material & Completion

Category	Item	Pin Socket	Socket Contact Spring (crown contact)
Contact	Material	Copper	Copper Alloy
	Finishing	Nickel Undercoat Silver Plating	Nickel Undercoat Gold Plating
Board Side Tab Post	Material	Copper	
	Finishing	Nickel Undercoat Silver Plating	
Housing	Material	UL94V-0, glass-reinforced thermoplastic PBT	

Safety Specifications

For safety specifications, please contact our sales department or purchase distributor.

D-7000 Series Contact

- Crimped types

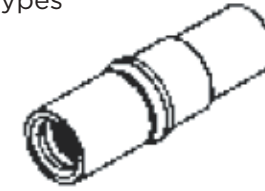

Socket Contact (socket housing usage)

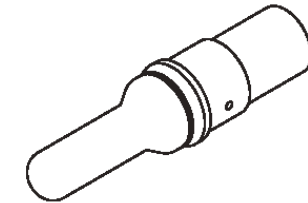

Pin Contact (pin housing usage)

- Gold-plated, Silver-plated type

Applicable Wiring Range		External Insulation Coating	Contact Part Number		Applicable Tool Part Number		
AWG	mm ²		Socket Contact	Pin Contact			
16-14	1.6-2.6	10	1871132-4	-	409777-1 *1		
12-10	2.7-6.6	10	1871132-3	Standard	1871131-3	2155369-1 *2	2155816-1 *3
				Long	1-1871131-3		2155815-1 *4
8	6.7-10.5	10	1871132-2	Standard	1871131-2		2155814-1 *5
				Long	1-1871131-2		
6	10.6-16.7	10	1871132-1	Standard	1871131-1	2155810-1 *6	
				Long	1-1871131-1		

Note: When placing your order, please check with the confirm sale slots.

Please contact our sales department or preferred distributor for more information.

1. hand tool (Crimp geometry is W crimp).
2. electro hydraulic tool for more information see P.109 If you have any questions please contact AT tooling Sales Department (044 - 900 - 5027)
3. Dice (2155369-1 use with electro hydraulic tool / applicable wire is AWG #12 / crimp format is hexagonal)
4. Dice (2155369-1 use with electro hydraulic tool / applicable wire is AWG #10 / crimp format is hexagonal)
5. Dice (2155369-1 use with electro hydraulic tool / applicable wire is AWG #8 / crimp format is hexagonal)
6. Dice (2155369-1 use with electro hydraulic tool / applicable wire is AWG #6 / crimp format is hexagonal)

The receptacle contact can be used in all receptacle housings, the tab contact can be used in all tab housings For details see P. 109

NOTE: All products are RoHS compliant On selection. You need to confirm LOT and lead time

D-7100

Part Number Chart

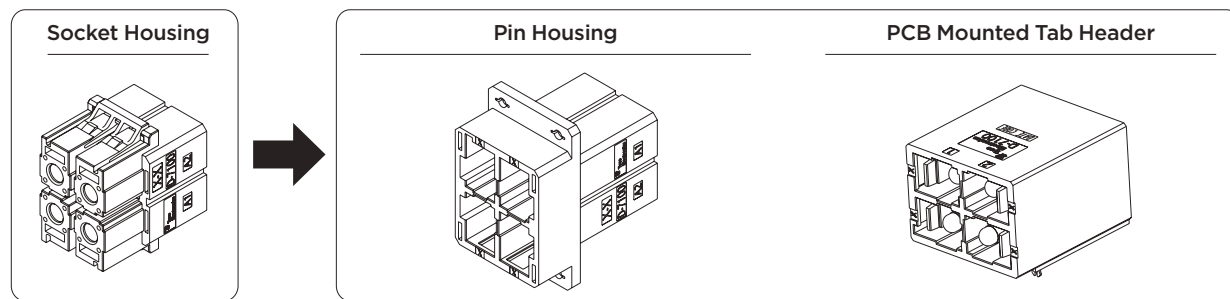

No. of Pos.	Color	Socket Housing	Plating	Pin Housing	Board Mounted Tab Header
4	Black	2134055-1	Silver	2134057-1	1981823-1

Related product information

Application Contact ...P.96
Performance • Specifications ...P.95

External Dimension

- Socket Housing
4 Pos. Model
number : 2134055-1

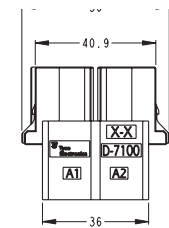
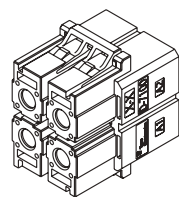

- Pin Housing
Panel type
4 Pos. Model
number : 2134057-1

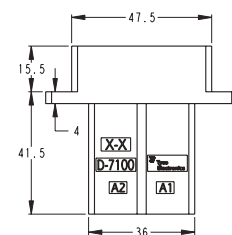
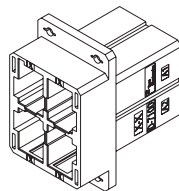

- Board Mounted Tab Header
4 Pos. Model
number : 1981823-1

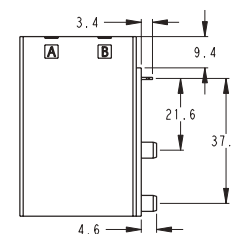
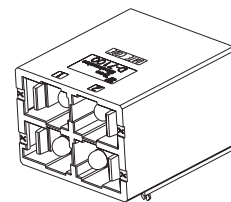

NOTE: All products are RoHS compliant On selection.
You need to confirm LOT and lead time

D-7300

Part Number Chart

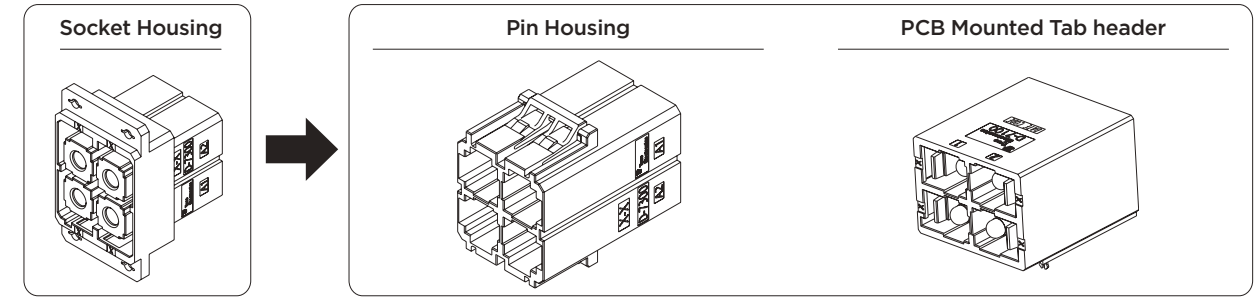

No. of Pos.	Color	Socket Housing	Plating	Pin Housing	Board Mounted Tab Header
4	Black	2134059-1	Silver	2134061-1	1981823-1

Related product information

Application Contact ...P.96
Performance • Specifications ...P.95

External Dimension

- Socket Housing
4 Pos. Model
number : 2134059-1

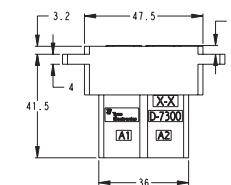
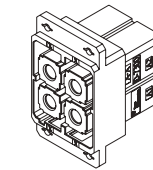

- Pin Housing
Panel type
4 Pos. Model
number : 2134061-1

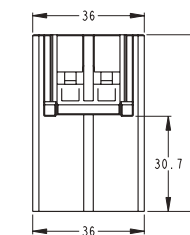
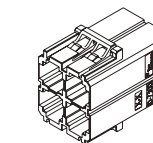

- Board Mounted Tab Header
4 Pos. Model
number : 1981823-1

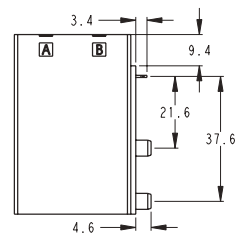
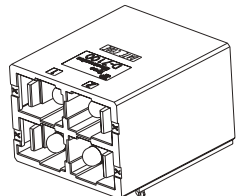

NOTE: All products are RoHS compliant On selection.
You need to confirm LOT and lead time

D-7100 Dyna-Clamp Kit

External Dimension

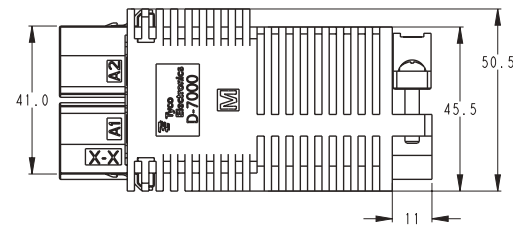

No. of Pos.	Color	Cable Size	Part Number
4	Black	S Φ 19-25	2-2069313-1
		M Φ 25-31	1-2069313-1

D-7300 Dyna-Clamp Kit

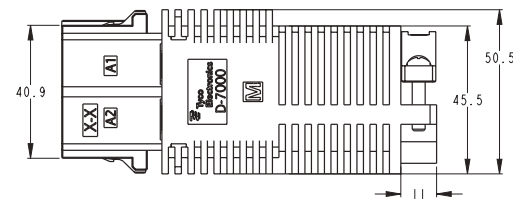

No. of Pos.	Color	Cable Size	Part Number
4	Black	S Φ 19-25	2-2069312-1
		M Φ 25-31	1-2069312-1

Related product information

Application Contact ...P.96
 Performance • Specifications ...P.95

NOTE: All products are RoHS compliant On selection.
 You need to confirm LOT and lead time

Dynamic Pneumatic Connector

Series Introduction

Couplings are used in various ways in industrial equipment. Some large industrial equipment may use several thousand couplings in one piece of equipment. However, we have heard from people on site about leaks caused by partially inserted tubes, leaks from damaged tubes, problems from misconnected tubes, time used on site for assembly, and other issues. To solve these problems, we developed the Dynamic pneumatic connector. We developed an air line connector that requires no special skills and can be assembled correctly by anyone. Plus it reduces time for designing and assembly on site where time constraints often result in misconnections during assembly. These new connectors, a dramatic improvement on next generation air line connections, were produced through a joint development of contacts with another coupling manufacturer combined with our reliable Dynamic series housing.

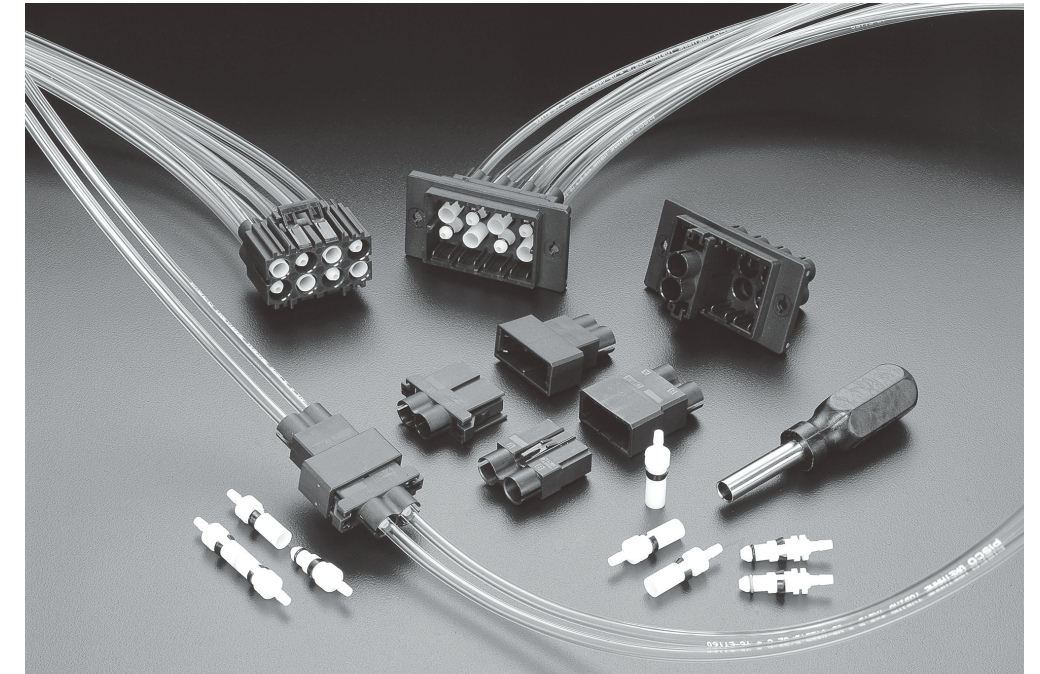

Product Features

- 2 types of Contact: Metal and Plastic
 There are two types of contact in the The series of Dynamic Pneumatic Connectors, which are made from different materials metals and resins. You can choose the resin type for applications requiring light weight and low cost, and choose metal type for using in environment with high pressure and temperature.
- Compatible to the tubes with an outside diameter of $\phi 4$, $\phi 6$ of Tube with an outside diameter of $\phi 4$ or $\phi 6$ can be accommodated. These sizes are the most commonly used in the industrial equipment.
- Universal design
 There are two types of housing; plug and cap. The contact can be loaded to either one. The loading variations of the male and female contacts allow keying functionality (to prevent misinsertion). Holes were made as small as possible to make pattern design easy (patent pending).
- Modular Housing structure
 The 8P plug housing can fit the 8P cap housing. However you can also use the 2P plug housing with max 4 to fit it, which makes it ideal to the distribution of airline.
- Maximum force of 1.0 MPa
 Even though connector mating and demating is easy, a maximum pressure of 1.0 MPa is guaranteed. They can be used as replacements on the same line as normal couplings.
- Two types of O-RING
 Two types of seal materials are available for O rings, NBR and, for non-petroleum applications, FKM. Select FKM for clean-environment air lines.

Dynamic Pneumatic Connector

Performance Specifications

Item	Standard Value	
	Resin Contact	Metal Contact
Working Fluid	Air	Air and Water
Maximum Pressure Used	0.8MPa	1.0MPa
Effective Cross-Sectional Area	3.14mm ²	8.80mm ²
Tube Holding Force	39.2N	39.2N(φ4)
		58.8N(φ6)
No. of Insertions and Withdrawals	500 times	
Insertion force/Pin	9.8N max	
Withdrawal Force/Pin	9.8N max	
Ambient Temperature Use	0-60°C (NBR)	
	0-105°C (FKM)	
Applicable tube	O.D. : 4mm	OD. : 4, 6mm
	ID. : 2.5mm	ID. : 2.5, 4mm

Applicable Tube

Tube Description	Material
PN	Polyolefin type
PFA	Fluorine Resin
Urethane	Polyurethane type
Nylon	Nylon type

Performance Specifications

Product Standards	108-78406
Withdrawal Tool Product Number : 1999435-1	411-78240
Test report	501-5782

Material & Completion

Category	Material
Resin Contact	Polyacetal Resin
Metal Contact	Brass/Nickel Plated
Plastic Ring	Polyester Resin
O ring	Nitrile Rubber (NBR) Fluorine Rubber (FKM).
Housing	UL94V-O, Glass-Filled Polyester PBT black

Part Number Chart

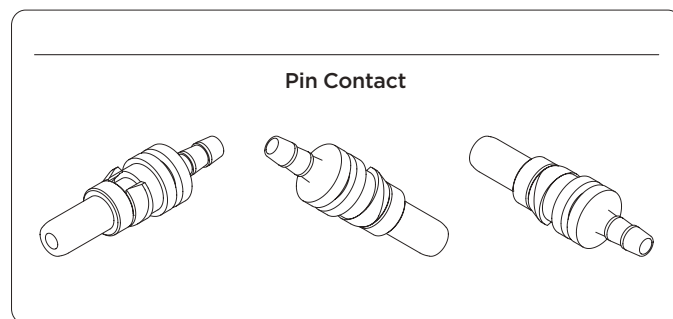
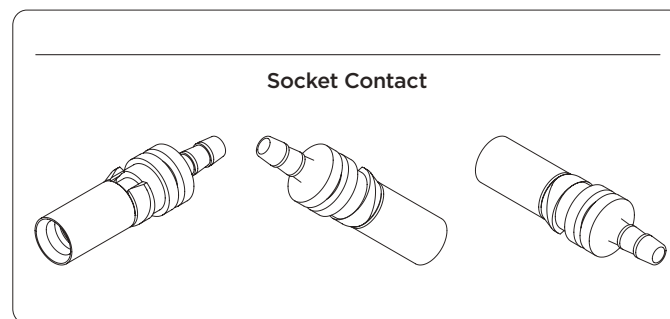

Applicable Tubing OD diameter	Contact Material	Socket Contact	Pin Contact	Puller
4	Resin	1903289-1*	1903100-1** 1903100-2***	1999435-1
	Metal	2013714-1* 2013714-2*	2013716-1	
6	Metal	2013597-1*	2013599-1	
		2013597-2*		

O rings: plastic contact loads to pin contact side, metal contact loads to socket contact side.
All contacts fit all housings

- O ring material is NBR
- O ring material is FKM

NOTE: All products are RoHS compliant On selection.
You need to confirm LOT and lead time

Dynamic Pneumatic Connector

External Form

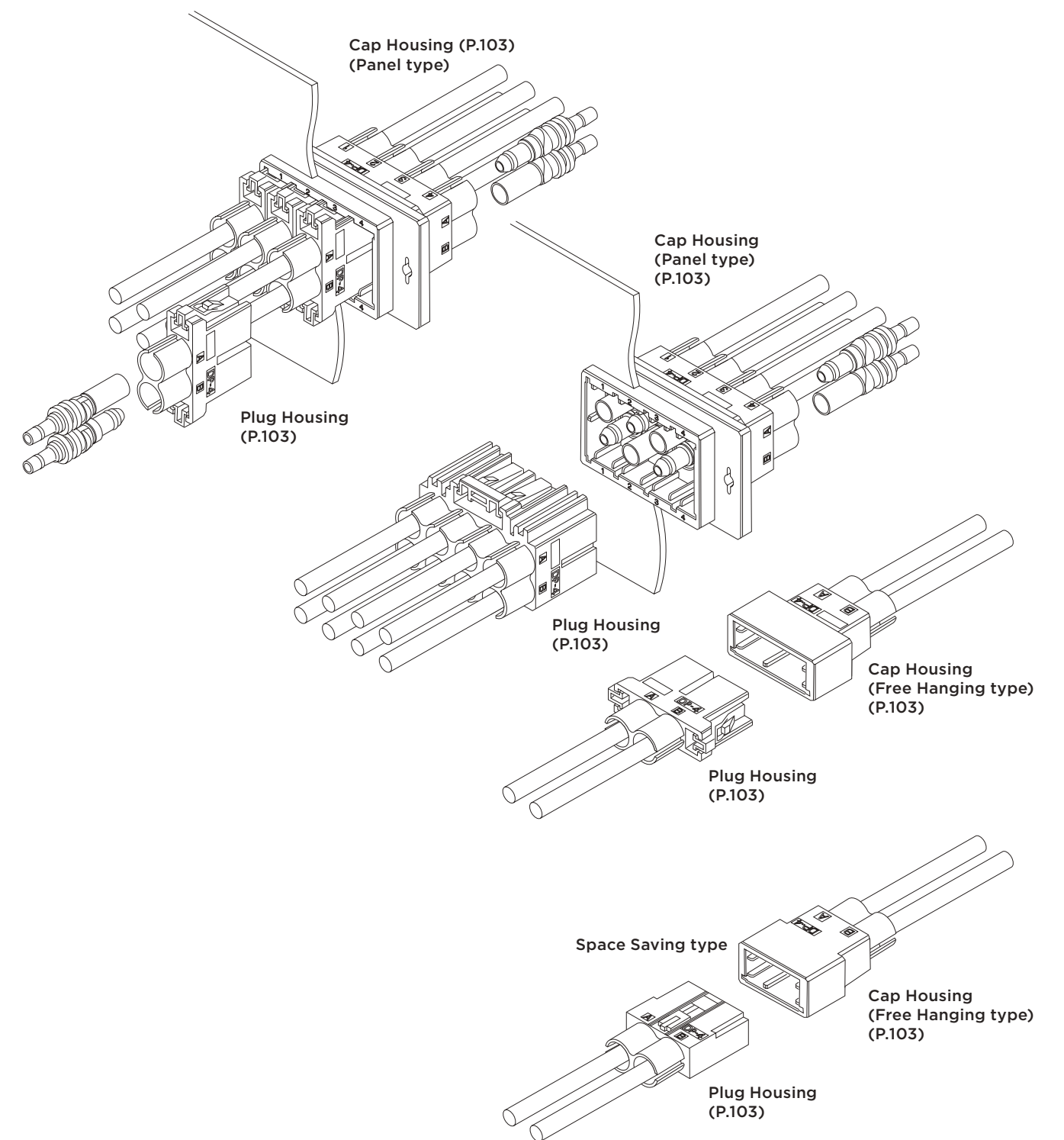

NOTE: All products are RoHS compliant On selection.
You need to confirm LOT and lead time

Dynamic Pneumatic Connector

Part Number Chart

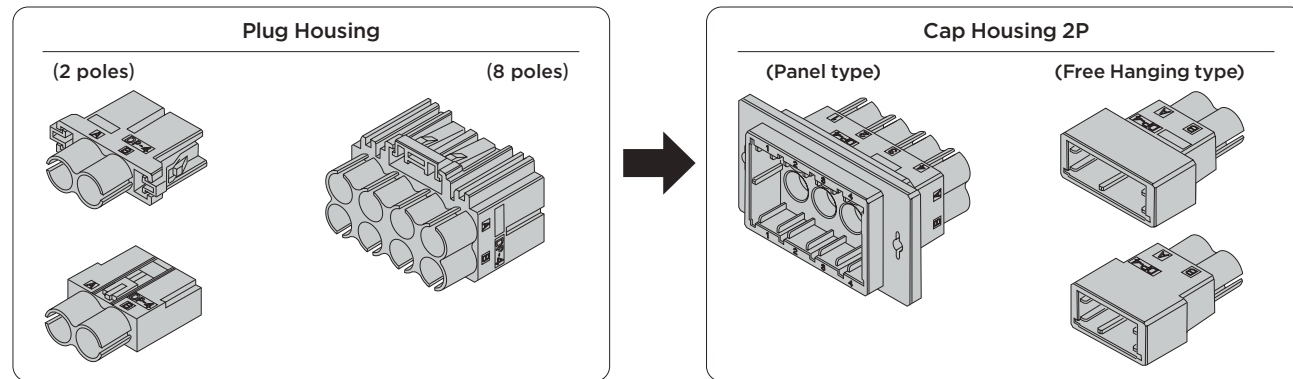

No. of Pos.	Plug Housing	Cap Housing	
		Panel type	Free Hanging type
2	1903105-1	-	1903305-1
2	1981040-1*	-	1981039-1*
8	1903104-1	1903106-1	-

* space saving type

Related product information

Application Contact ...P.101
Performance • Specifications ...P.101

External Dimension

• Plug Housing (2 pole)

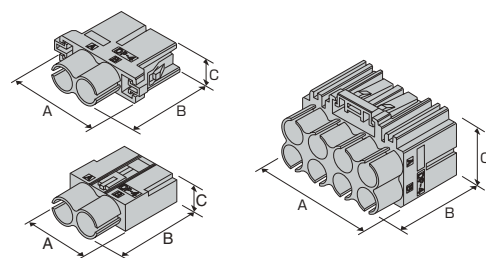

No. of Pos.	Keying	Plating	Color	Part Number	Dimensions		
					A	B	C
2	-	-	Black	1903105-1	32.0	27.8	9.2
2	-	-	Black	1981040-1*	21.5	27.8	10.9
8	-	-	Black	1903104-1	37.7	27.8	31.3

* space saving type

• Cap Housing

Panel type Free Hanging type

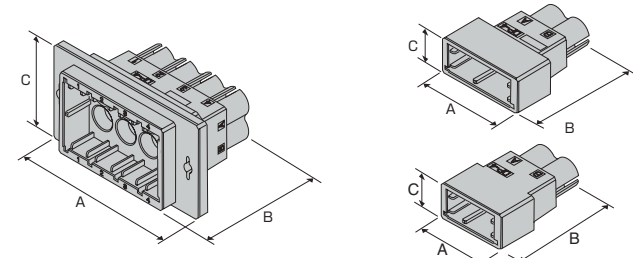

No. of Pos.	Keying	Plating	Color	Part Number	Dimensions		
					A	B	C
2	-	-	Black	1903305-1	28.1	32.3	12.8
2	-	-	Black	1981039-1*	24.7	32.3	12.7
8	-	-	Black	1903106-1	58.9	32.3	32.1

* space saving type

NOTE: All products are RoHS compliant On selection.
You need to confirm LOT and lead time

Multiple Enclosure Connector

Series Introduction

Human machine interfaces (HMI) can be found on a variety of machines. They allow people to interface with equipment to control, operate and program. The multiple enclosure connector was developed as a connector for I/O interfaces for HMI. They have superior operability, are very safe, easy to use and there are multiple varieties. Plus, they use Dynamic series contacts to give them very high reliability. There are two types in the line up, metal and plastic, used according to the environment. You can make a selection based on your application.

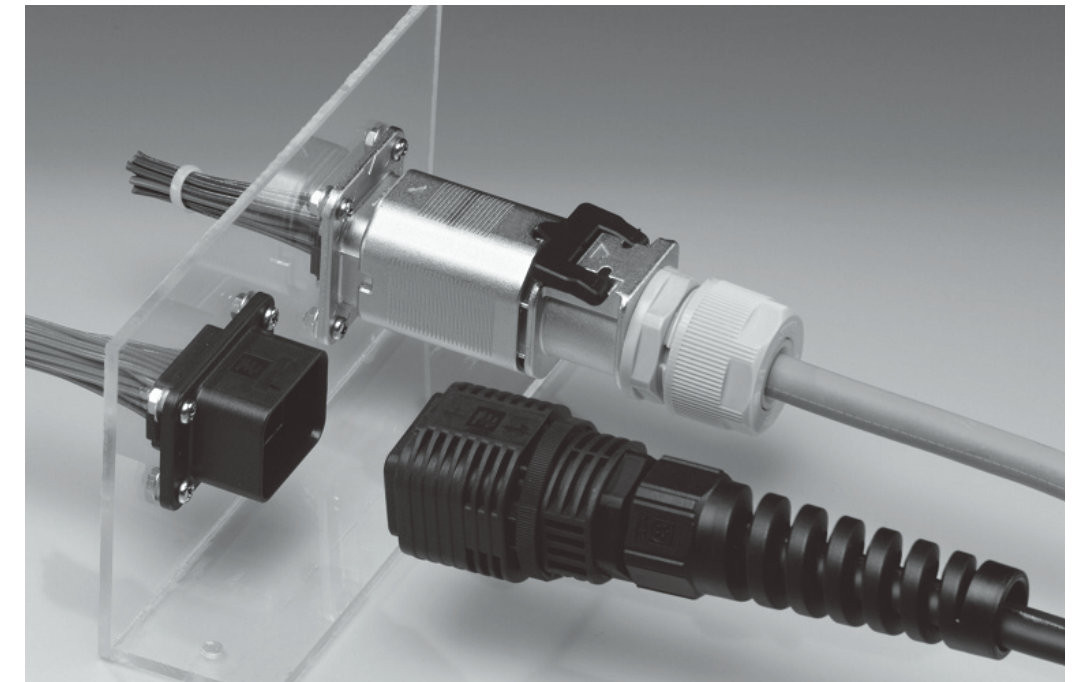

Product Features

- Wire Sizes**
The metal type supports wires with a finished diameter of 10mm to 11mm, the molded type from 5mm to 12mm.
- Applicable Terminals**
The highly reliable Dynamic D-1000 and D-3000 series terminals are used as contacts for I/O connectors for human machine interfaces (HMI). These can be crimped by using existing Dynamic crimping tools.
- IP65 (molded type), IP67 (metal type) ingress protection.**
The connectors have dust and water-proofing for use in harsh conditions.
- Safety Lock Mechanism**
The lock mechanism uses the fast on/off lock concept which can be locked or released by just grabbing the connector. Plus, our proprietary double lock mechanism prevents vibration related disconnect accidents.
- Two Types of Housing**
The lineup includes two types of housing, a standard type and a reverse type for preventing exposure of live contacts.
- Cable Clamp Interface**
Cable clamps, which are commercially available and can be selected according to application and purpose, can be attached to cover the cable entering the connector.
- Other Considerations**
Safety caps with a definite locking sound to confirm connections are also available.

Multiple Enclosure Connector

Performance Specifications

Items	Standard
Current Rating	see right
Voltage Rating	125VACrms (2mm pitch products)
Dielectric Withstanding Voltage	1000VAC (1 minute)
Operating Temperature	-30°C-105°C (including temperature rise through power conduction)
Total Resistance (low level)	10mΩ max (initial)
Insulation Resistance	1,000MΩ minimum (initial)
Insert Strength	39.2N max (per pole)
Withdrawal Strength	4.9N max (per pole)
Durability	50 times
Enclosure Lock Strength	98N min

Performance Specifications

Items	Standard
Product Standards	108-78417
Mounting Application Standard	114-5377
Manual	411-78287, 78288 (14+1P) 411-78262, 78277 (24P)

Mold type

Items	Standard
Product Standards	108-78566
Mounting Application Standard	114-5377
Manual	411-78293 (32P)

Contact Refer to D-1000, D-3000

Housing

Wire size	Receptacle Contact Tab Contact						
No. of Pos.	AWG #18	AWG #20	AWG #22	AWG #24	AWG #26	AWG #28	AWG #30
24Pos	-	-	2	1.5	1	0.8	0.5
14+1Pos	3.5	2.7	2.5	2	1.5	1	0.8

Mold type

Wire size	Receptacle Contact Tab Contact				
No. of Pos.	AWG #22	AWG #24	AWG #26	AWG #28	AWG #30
32Pos	1.5	1	0.8	0.5	0.5

Material & Finish

Description	Material	Finish
Contact	Copper Alloy	Contact Portion: Gold Plated Undercoat: Nickel Plated
Housing	94 UL V-0, Thermoplastic Polyamide	-
Connector Case	Zinc	Nickel Plated
Packing	Nitrile Rubber	-
Shield Grip	cold rolled steel	Completion: Nickel Plated Undercoat: Copper Plating

Mold type

Description	Material	Finish
Contact	Copper Alloy	Contact Portion: Gold Plated Undercoat: Nickel Plated
Housing	94 UL V-0, Thermoplastic Polyamide	-
Connector Case	94 UL V-0, Thermoplastic Polyamide	-
Packing	Nitrile Rubber	-

Multiple Enclosure Connector

Part Number Chart

Outside Diameter Dimension

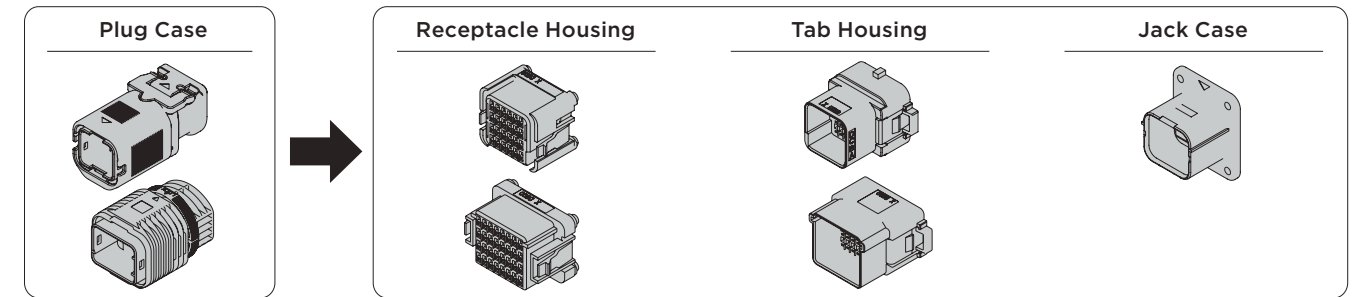

	Plug Case	Housing			Jack Case
		Receptacle (R) /Tab (T)			
24	1939847-1	Standard type	1939850-1 (R)	1939839-1 (T)	1939840-1
	1981560-1	Reverse	1981556-1 (T)	1981551-1 (R)	
14+1	1939847-1	Standard type	1981135-1 (R)	1981133-1 (T)	1939840-1
	1981560-1	Reverse	1981947-1 (T)	1981945-1 (R)	
32	1981919-1	Standard type	1981921-1 (R)	1981914-1 (T)	1981913-1
		Reverse	2013393-1 (T)	2013391-1 (R)	

Shield clip P /N 1939851 - 1 (plug case) tool: 1891820 - 1 (411-78273)

Related product information

Application Contact ... 24-pole: D - 1000 series P. 13
14+1P pole: D-1000 series, D-3000 series P13, 38
32 P pole: D - 1000 series P. 13

External Dimension

• Receptacle Housing Standard (Plug Case)

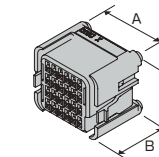

No. of Pos.	Keying	Plating	Color	Part Number	Dimensions		
					A	B	C
24	-	-	Black	1939850-1	19.6	15.3	16.8
14+1	-	-	Black	1981135-1	22.0	22.8	16.8
32	-	-	Black	1981921-1	27.2	15.3	17.6

Reverse (Jack Case)

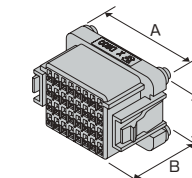

No. of Pos.	Keying	Plating	Color	Part Number	Dimensions		
					A	B	C
24	-	-	Black	1981551-1	27.5	23.7	20.2
14+1	-	-	Black	1981945-1	27.5	23.7	20.2
32	-	-	Black	2013391-1	29.5	23.0	17.0

• Tab Housing Standard (Jack Case)

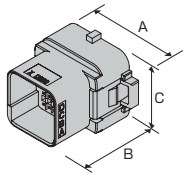

No. of Pos.	Keying	Plating	Color	Part Number	Dimensions		
					A	B	C
24	-	-	Black	1939839-1	27.5	23.3	20.0
14+1	-	-	Black	1981133-1	27.3	27.5	20.2
32	-	-	Black	1981914-1	29.5	22.3	17.0

Reverse (Plug Case)

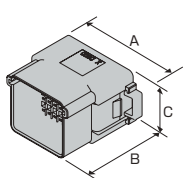

No. of Pos.	Keying	Plating	Color	Part Number	Dimensions		
					A	B	C
24	-	-	Black	1981556-1	19.6	20.8	16.8
14+1	-	-	Black	1981947-1	22.8	28.2	16.8
32	-	-	Black	2013393-1	27.2	20.0	17.6

NOTE: All products are RoHS compliant On selection.
You need to confirm LOT and lead time

Applicable Tools

- AMP - 3K/AMP - 5 K Tabletop Crimping Machine.

AMP - 3K/AMP - 5 K is a compact, low-cost desktop crimping machine. A DC motor linear scheme is used for low noise and motor speed adjustment can be easily changed. It offers a wide range of crimping operations options with simple operation and a comfortable working environment.



Name	AMP-3K	AMP-5K
Type Universal Mount Type	1725950-3	1725900-3
no. AMP Quick Mount Type	1-1725950-2	1-1725900-2
Stroke	30 mm stroke	
Dimensions	safety cover closed with side feed applicator (Reels) : 512 mm (width) X 415 mm (depth) x 510 mm (height).	
	safety cover closed with side feed applicator (Reels) : 427mm (width) X 523mm (depth) x 510 mm (height).	
Weight	approximately 70kg (Crimp machine itself).	
Power Source	100 and 240 V AC (+ /- 10 %) single phase 50/60 Hz (6A)	
Cycle Time	0.4 seconds (Jog mode feature when released).	

- SCM Stripper Crimping Machine (Tabletop Crimping Machine)

Stripper Crimping Machine with exchangeable Dices. With optimum processing of jacket cable ends, the operator selects strip, and crimp, strip only or crimp only with one touch.

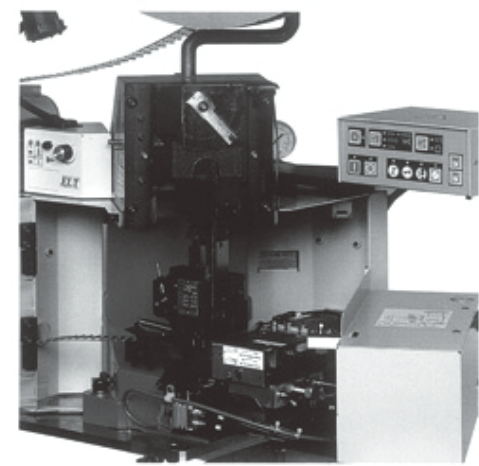

AMP - 3K SCM specification.

Type	AMP - 3K specification. 1596509-3	AMP - 3K specification. 1596509-4
Applicable Wire	AWG 32-14 max high-insulation outline 5.08mm (some AWG 32- 30 is not suitable). For details please contact us	
Jacket strip Dimensions	Min 29mm (for 29 - 45mm strip, wire set). time takes a little more than usual	
Strip Length	2.5 - 10mm	
Usable Applicators	Our 40mm stroke side feed applicator (Side Feed).	
Noise Level	< 82 dB	
Crimp Ability	13,345 N (1,360 kgf) AWG 14 crimp.	22,226N (2,268 kgf) AWG 10 crimp (SCM up to AWG14)
Power Supply	AC 100-240 V single-phase 50/60 Hz	
Air Pressure	0.49 - 0.59MPa(5 - 6kg/cm ²)	
Machine Weight	Approximately 80kg	

Dynamic Series Connectors

D-3900/D3950 - Spring Clamp Tool

Tool pictured in Receptacle Assembly

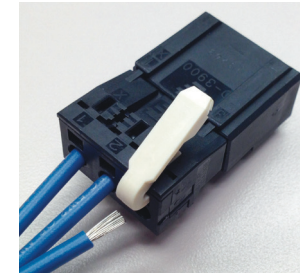

TE Part # 1981045-1
Used on both 3900 & 3950 Series Receptacle Assemblies

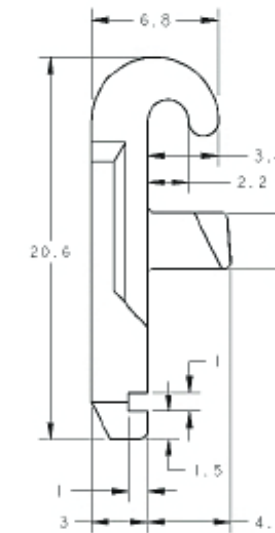

D-1900 - Spring Clamp Opener Tool

Tool pictured in Receptacle Assembly

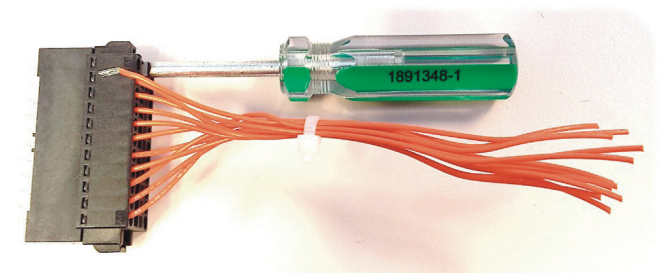

TE Part # 1891348-1
Used on all 1900 Series Receptacle Assemblies

Dynamic New Hand Tools

CS-10 Straight Action Tool

Series CS-10

The linear crimping series CS 10 is a smaller and lightweight when compared to other series.

Specifications

- Crimping of wire and insulation in one step
- Simple contact positioning even for mini contacts by flap-locator
- Outstanding crimping performance
- Can be equipped with integrated wire stripping device
- Easy handling due to outstanding force transmission ratio
- Small size
- Ergonomically designed soft handles
- Safe operation
- Wide range of application possibilities
- Releasable ratchet ensures the complete crimping process

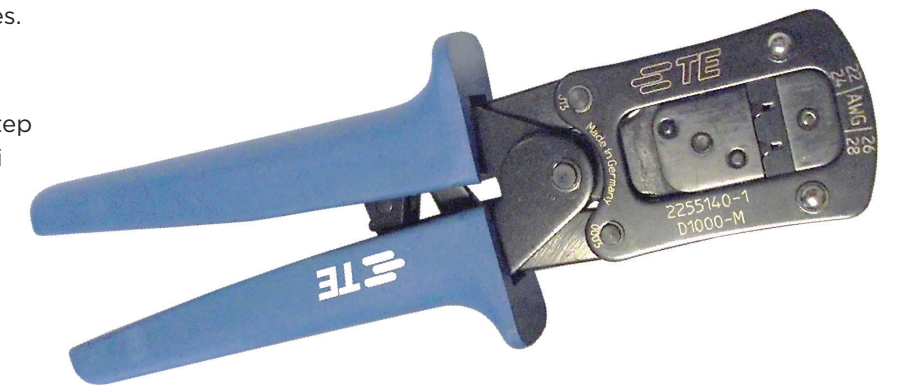

AWG	
D1000 Series	CS-10 Straight Action Tool
22-20	2255142-1
28-22	2255140-1
28-26	2255141-1
30-28	2255139-1

AWG	
D2000 Series	CS-10 Straight Action Tool
22-18	2255144-1
28-24	2255143-1

AWG	
D3000 Series	CS-10 Straight Action Tool
16-14	2255149-1
16-14	2255148-1
20-16	2255147-1
24-20	2255146-1
28-24	2255146-1

Applicable Tools

- Hand Tools: PEW 12, D-1000 Series, D-3000 Series, D-4000 Series



- Crimping with a straight action feel
By manipulating the fulcrum of the handle, we have created a crimper that, while double action, is almost like straight action.
- Interchangeable dies
The dies are easy to change. This means a wide variety of terminals can be handled with the minimum number of tools.
- Improve work efficiency
Contact series, wire sizes and crimp heights printed on work surface of dies.
- Lower cost than existing specialized tools
The superior functionality you want, at a price you like.

- Hand Tools CERTI-CRIMP II, D-1000 Series Flip Locator, D-2000 Series, D-3000 Series, D-5000 Series
Crimp part, as well as the machine, are highly reliable, Straight action method is introduced.



D - 1000 series flip locator.

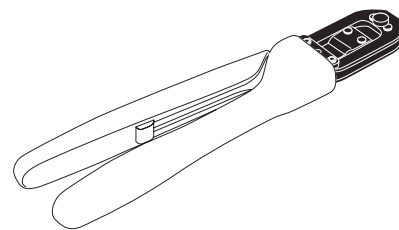

Model number: see P. 28, 38, 72

Handles are completely covered in urethane to be easy to grip and gentle to workers' hands. Wire ranges and crimping height control values are printed on the crimping head for easy confirmation while working. Also, the ratchet in the handle keeps crimping quality very consistent. Hand crimping tool with wire stripper has four variations, while the previous model had only three variations. We recommend periodic maintenance when using hand crimping tools to keep crimping quality consistent.

- Hand Tool Series D-4000
Crimper uses the reliable straight action method

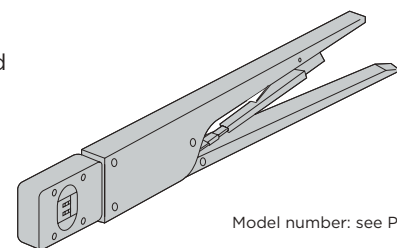

Model number: see P. 28, 38, 72

- Hand Tool D-5000 Series
As with machine use, the reliable straight action method is used.

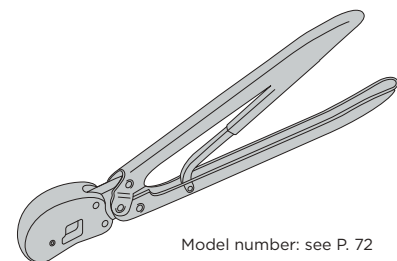

Model number: see P. 72

Applicable Tools

- TE REC-Li 250 M (charging hydraulic multi-function tool)
- The lithium-ion battery is the lightest in its class .
- High power thanks to dual Battery-electric & hydraulic pump use.

Product Specification
 Rated output 54 kN
 Crimp Range: 5.5 to 60mm² electric machine:
 14.4 V DC motor
 External dimensions 286 mm (length) x 285mm (H) x 75mm (width)
 Weight: 2.7 kg (6 lb) (60 mm 2 Dices, battery pack included)
 No. of times can be crimped: 270 times (60 mm 2crimp per hour).
 Manufacturer Part Number: 2155363 - □



- TE REC-Li 250 M (charging hydraulic multi-function tool)

Product Specification
 Rated output 127kN
 Crimp Range: 14 to 250 mm² (copper wire bare pressure terminal and sleep)
 Electric motor: 14.4 V DC motor
 External dimensions 340mm (length) x 280mm (H) x 75mm (width)
 Weight: 4.2kg (250mm 2 Dices, battery pack included)
 No. of times can be crimped: 50 times (250mm 2crimp per hour).
 Manufacturer Part Number: 2155363 - □

- Keying Plug D-2000 series (used to prevent misinsertion)
Keying plug is used to preclude the possibility of contacts inserted in wrong directions when using connectors of the same size end-to-end.

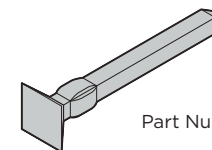

Part Number: 641994 - 1

- Tab Contact Cutting Tool D-2000 Series

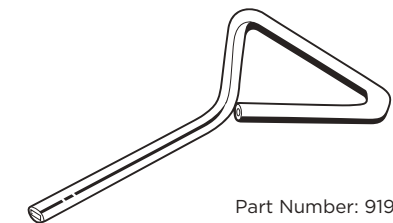

Part Number: 919041 - 2
Manual: 411 - 78047

How to use the plug and fixture

* It should be noted that some of the products (D-2100 S/D-2100 D) to prevent mis-insertion, use keying mechanism from the beginning.

(1) Keying Plug inserted in one pole of the receptacle housing.

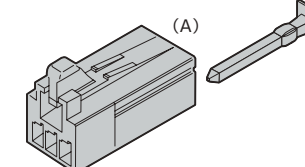

(2) Wrench off a tab in the corresponding position of mating Tab Header and empty that position. To wrench off the tab, insert Cutting Jig into its root and turn tool as shown.

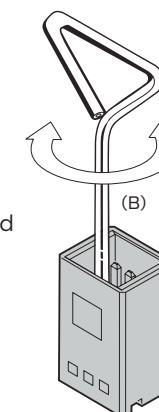

* In tab Housing (Panel/freehanging type), 1 pole is not inserted and is left free.

Applicable Tools

- Extraction Tool for D-1000 Series
Used to pull D-1000 from the housing

Part number 1891526-1
Manual: 411-78241

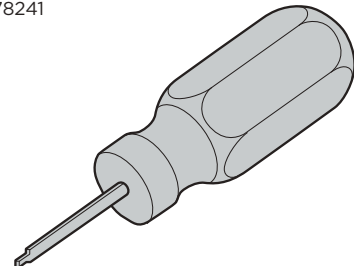

- Extraction Tool for D-2000 Series
Used to pull D-2000 contacts from the housing

Part number 1276716-1
Manual: 411-5900

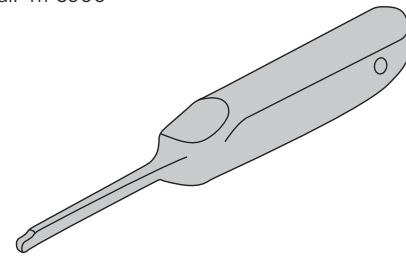

- Extraction Tool for D-3000 Series
wiring type tool for pulling the contact from the housing

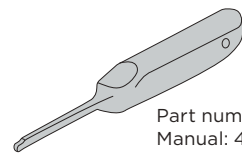

Part number 234168-1
Manual: 411-5726

using the extractor

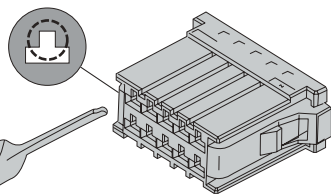

- (1) Extractor tool is inserted into the small, upper part of the convex hole in the housing as shown in the diagram (please hold the tool the right way up)

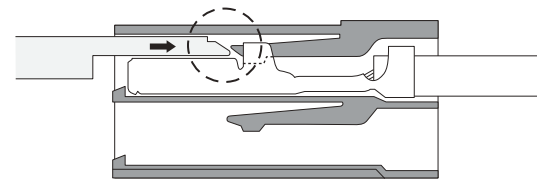

- (2) The tip of the tool lifts the housing lance and frees the contact

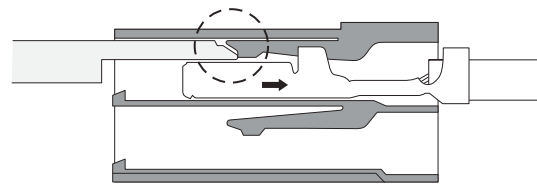

- (3) Contact can be withdrawn

* Take care not to insert into the Contact Section. If you have inserted by error, replace the damaged contact with a new one before proceeding.

Applicable Tools

- Keying Plug for D-3000 Series
(used to prevent misinsertion)
Keying plug is used to preclude the possibility of contacts inserted in wrong directions when using connectors of the same size end-to-end.

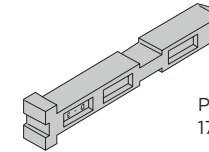

Part Number:
175855 - 1

- Tab Contact Cutting Tool D-3000 Series

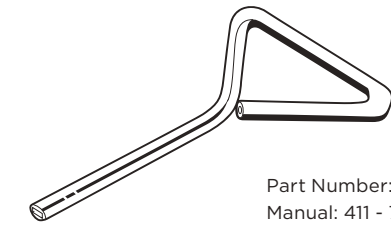

Part Number: 919041 - 1
Manual: 411 - 78047

How to use the plug and tool for the D-3000 Series

In addition, mis-insertion function keying has been installed from the beginning in some of the products (D-3100S/D-3100M/D-3200S/D-3200M)

- (1) The keying plug is inserted into the receptacle housing

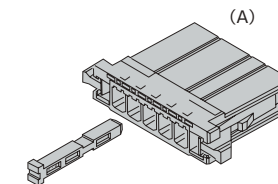

- (2) Wrench off a tab in the corresponding position of mating Tab Header and empty that position. To wrench off the tab, insert Cutting Jig into its root and turn tool as shown.

* In tab Housing (Panel/freehanging type), 1 pole is not inserted and is left free.

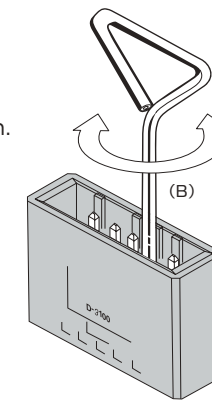

- (3) When using these, it is impossible to mis-insert

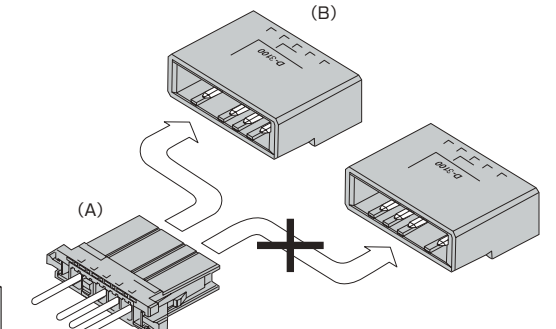

- Extraction Tool for D-5000 Series

Wiring type tool for pulling the contact from the tab / receptacle housing (between D-3 and D-5 the lance part is inverted, so please take care on insertion)
In D-5 contact only, pulling can be achieved with a small O-driver or awl

Part number 409158-1
Manual: 411-5774

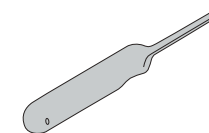

Using the Extraction Tool

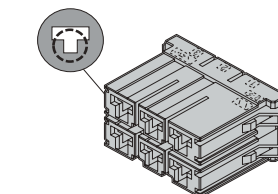

- (1) The pulling tool should be inserted into the narrow part of bottom, with convex hole in the housing as shown in the diagram.

If using the D-5 Extraction Tool

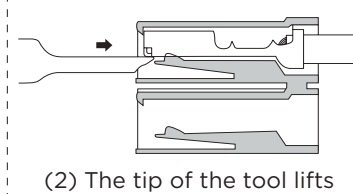

- (2) The tip of the tool lifts the housing lance and frees the contact

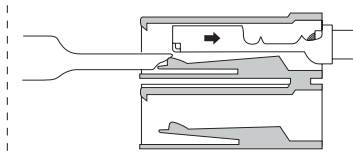

- (3) Contact can be withdraw

If using a small O-driver or awl

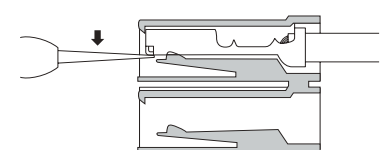

- (2) The tip pushes down the lance part and frees the contact

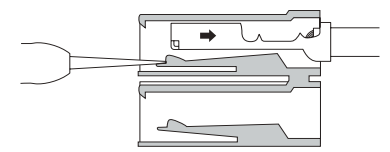

- (3) Contact can be withdraw

Please note that the contact cannot be inserted into the contact section. If you have inserted by mistake, please replace and use a new one.

- Crimping Oil Model number: 939691-1. For easing the friction between tool and contact during crimping



- Sequential Clip

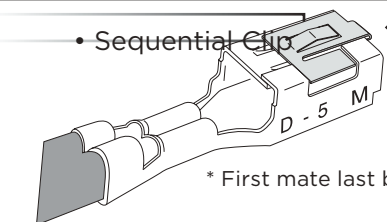

* First mate last break.

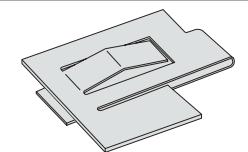

Part number 179993-1

Accessories

• L bracket D-3000

Used to secure free-hanging type tab housings onto panels. Two styles, large and small, are available, the former for large-sizes housings and the latter for small housings. Applicable housings are specified in the table of housings
 5900121-2 (S)
 5900121-4 (L)

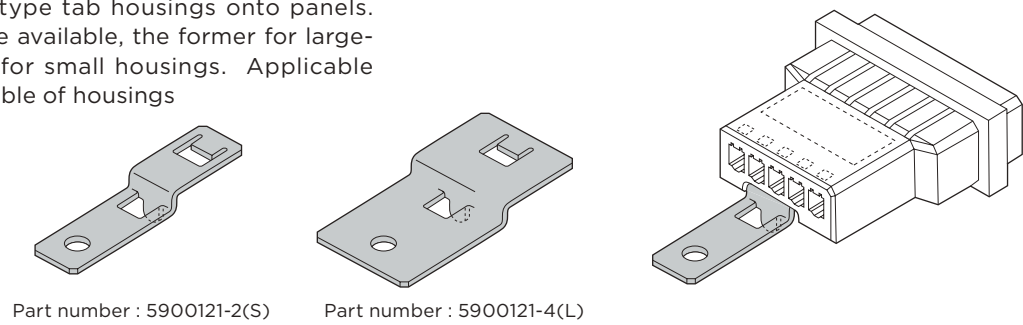

• Push rivets D-3000

Used to secure panel-type tab housings onto panels (Use as a handy mounting hardware. Cannot be used with larger sized housings or those that are frequently inserted and withdrawn).

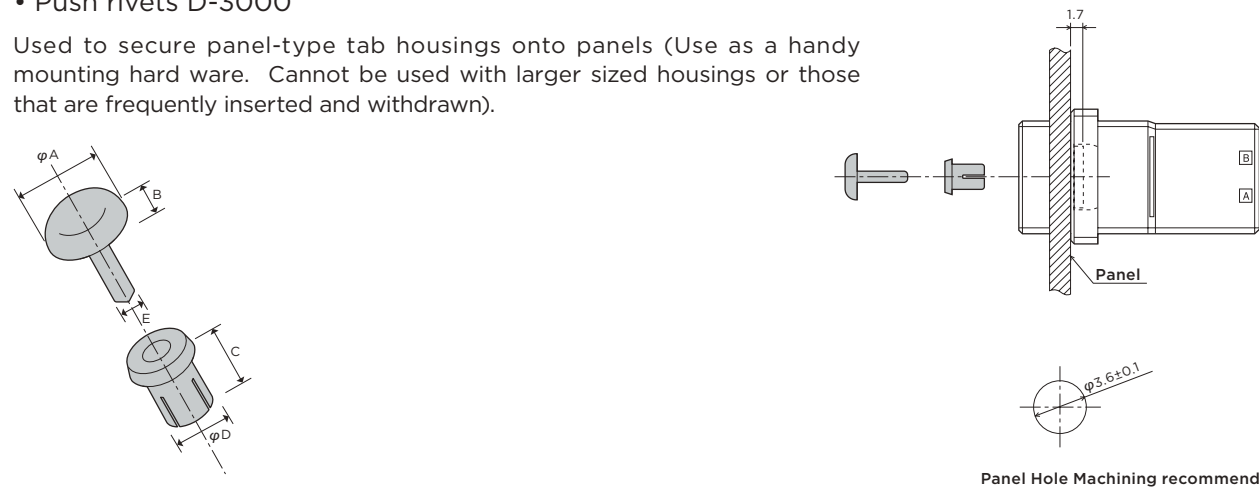

Part Number	Panel Thickness	Dimensions					Insert Strength	Retention Force
		A	B	C	D	E		
900128-1	0.3-1.3	6.4	1.6	4.5	3.5	1.95	19.6N-29.4N	127.4N Min.*
900128-2	1.3-2.3	6.4	1.6	5.5	3.5	1.95	19.6N-29.4N	127.4N Min.*

* when using 2

Panel Mounting Screws D-2000, D-3000

Part Number	Dimensions		
	A	B	C
900167-1	9.0	10.3	M3

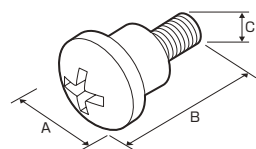

Panel Mounting Hex Screws D-2000

Part Number	Dimensions		
	A	B	C
1376059-1	5.5	12.3	M3

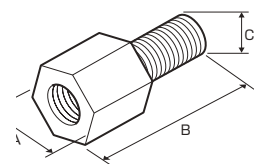

Part Number List

Contact Categories / Others

Part Number	Page	Part Number	Page	Part Number	Page	Part Number	Page
84695	72	179960	73,74	1318126	30,31	1871935	24
84696	72	316040	72,81	1318127	30,31	1871940	24
131896	72,81	316041	72,81	1318579	32	1903100	101
175194	38	316080	49,51	1318697	72,81	1903111	13
175195	38	316081	49,51	1318983	82	1903112	13
175196	38	316130	46,48	1318985	72,81	1903113	13
175216	38	316131	46,48	1318986	72,81	1903114	13
175217	38	316132	46,48	1376009	30,31	1903115	13
175218	38	316133	46,48	1376020	30,31	1903116	13
175284	38	316516	56,57	1376059	112	1903117	13
175285	38	316517	56,57	1376133	56,57	1903118	13
175286	38	353079	73,74	1376135	29	1903120	13
175287	38	353080	73,74	1376136	30,31	1903121	13
175288	38	353081	73,74,79,80	1376137	30,31	1903122	13
175289	38	353082	73,74,79,80	1473668	79	1903124	13
175365	56,57	353715	38	1717412	43,44	1903125	13
176346	58	353716	38	1747145	84	1903126	13
177555	56,57	353717	38	1747147	84	1903289	101
177662	42	353718	38	1747277	66,67	1903328	66,67
177665	42	641994	109	1747415	65	1903601	43,44
178136	46,48	900128	112	1747416	65	1939261	18,20
178137	45	900167	112	1747418	65	1939588	13
178138	46,48	917251	55	1747419	65	1939638	14,16
178139	49,51,52,53	917337	46,48	1747443	81	1939818	18,20
178140	49,51,52,53	917338	46,48	1747498	65	1939840	106
178141	45	917484	38	1747499	65	1939847	106
178216	55	917485	38	1747500	65	1939995	16
178293	39,41	917511	38	1747501	65	1971151	23
178294	39,41	917512	38	1747994	30,31	1971182	23
178295	39,41	917541	73,74	1827538	33	1981458	75,76
178296	39,41	917542	73,74	1827569	13	1981560	106
178297	39,41	917657	49,51	1827570	13	1981690	72
178298	39,41	917658	49,51	1827571	13	1981691	72
178303	43,44	917802	72	1827572	13	1981823	97,98
178305	43,44	917803	72	1827581	21,22	1981913	106
178306	43,44	917804	72,81	1827583	21,22	1981919	106
178307	43,44	917805	72,81	1827586	13	2013325	24
178308	43,44	1102770	93	1827587	13	2013407	20
178313	39,41	1102771	93	1827588	13	2013593	72
178314	39,41	1106005	93	1827589	13	2013594	72
178315	39,41	1106006	93	1827872	14,16	2013597	101
178316	39,41	1123309	75,76	1827873	14,16	2013599	101
178317	39,41	1123624	54	1827875	18,20	2013714	101
178318	39,41	1123829	75	1827876	18,20	2013716	101
178323	43,44	1318105	28	1871056	14,16	2040516	14,16
178325	43,44	1318106	28	1871131	96	2040558	18,20
178326	43,44	1318107	28	1871132	96	2069312	99
178327	43,44	1318108	28	1871303	13	2069313	99
178328	43,44	1318109	28	1871304	13	2069524	92
179188	42	1318110	28	1871315	14,16	2069526	92
179276	46,48	1318111	28	1871673	18,20	2174021	72
179277	46,48	1318112	28	1871731	13	2174022	72
179955	72,81	1318123	29	1871743	13		
179956	72,81	1318124	30,31	1871744	13		
179959	73,74	1318125	30,31	1871745	13		

te.com

© 2013 Tyco Electronics Corporation, a TE Connectivity Ltd. Company. All Rights Reserved.

1-1773732-4 IS BND 04/2014

TE Connectivity and the TE connectivity (logo) are trademarks of the TE Connectivity Ltd. family of companies. Other logos, product and Company names mentioned herein may be trademarks of their respective owners.

While TE has made every reasonable effort to ensure the accuracy of the information in this brochure, TE does not guarantee that it is error-free, nor does TE make any other representation, warranty or guarantee that the information is accurate, correct, reliable or current. TE reserves the right to make any adjustments to the information contained herein at any time without notice. TE expressly disclaims all implied warranties regarding the information contained herein, including, but not limited to, any implied warranties of merchantability or fitness for a particular purpose. The dimensions in this brochure are for reference purposes only and are subject to change without notice. Specifications are subject to change without notice. Consult TE for the latest dimensions and design specifications.



Mouser Electronics

Authorized Distributor

Click to View Pricing, Inventory, Delivery & Lifecycle Information:

[TE Connectivity:](#)

[1747501-2](#)