

TLV2731, TLV2731Y
Advanced LinCMOS™ RAIL-TO-RAIL
LOW-POWER SINGLE OPERATIONAL AMPLIFIERS

SLOS198A – AUGUST 1997 – REVISED MARCH 2001

- Output Swing Includes Both Supply Rails
- Low Noise . . . 15 nV/√Hz Typ at f = 1 kHz
- Low Input Bias Current . . . 1 pA Typ
- Fully Specified for Single-Supply 3-V and 5-V Operation
- Common-Mode Input Voltage Range Includes Negative Rail
- High Gain Bandwidth . . . 2 MHz at V_{DD} = 5 V with 600 Ω Load
- High Slew Rate . . . 1.6 V/μs at V_{DD} = 5 V
- Wide Supply Voltage Range 2.7 V to 10 V
- Macromodel Included

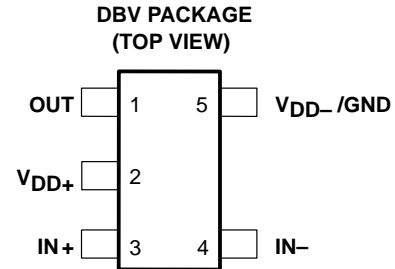

description

The TLV2731 is a single low-voltage operational amplifier available in the SOT-23 package. It offers 2 MHz of bandwidth and 1.6 V/μs of slew rate for applications requiring good ac performance. The device exhibits rail-to-rail output performance for increased dynamic range in single or split supply applications. The TLV2731 is fully characterized at 3 V and 5 V and is optimized for low-voltage applications.

The TLV2731, exhibiting high input impedance and low noise, is excellent for small-signal conditioning of high-impedance sources, such as piezoelectric transducers. Because of the micropower dissipation levels combined with 3-V operation, these devices work well in hand-held monitoring and remote-sensing applications. In addition, the rail-to-rail output feature with single- or split-supplies makes this family a great choice when interfacing with analog-to-digital converters (ADCs). The device can also drive 600-Ω loads for telecom applications.

With a total area of 5.6mm², the SOT-23 package only requires one-third the board space of the standard 8-pin SOIC package. This ultra-small package allows designers to place single amplifiers very close to the signal source, minimizing noise pick-up from long PCB traces.

AVAILABLE OPTIONS

T _A	V _{IO} max AT 25°C	PACKAGED DEVICES	SYMBOL	CHIP FORM‡ (Y)
		SOT-23 (DBV)†		
0°C to 70°C	3 mV	TLV2731CDBV	VALC	TLV2731Y
-40°C to 85°C	3 mV	TLV2731IDBV	VALI	

† The DBV package available in tape and reel only.

‡ Chip forms are tested at T_A = 25°C only.



Please be aware that an important notice concerning availability, standard warranty, and use in critical applications of Texas Instruments semiconductor products and disclaimers thereto appears at the end of this data sheet.

Advanced LinCMOS is a trademark of Texas Instruments.

PRODUCTION DATA information is current as of publication date. Products conform to specifications per the terms of Texas Instruments standard warranty. Production processing does not necessarily include testing of all parameters.



POST OFFICE BOX 655303 • DALLAS, TEXAS 75265

Copyright © 2001, Texas Instruments Incorporated

TLV2731, TLV2731Y
Advanced LinCMOS™ RAIL-TO-RAIL
LOW-POWER SINGLE OPERATIONAL AMPLIFIERS

SLOS198A – AUGUST 1997 – REVISED MARCH 2001

TLV2731Y chip information

This chip, when properly assembled, displays characteristics similar to the TLV2731C. Thermal compression or ultrasonic bonding may be used on the doped-aluminum bonding pads. This chip may be mounted with conductive epoxy or a gold-silicon preform.

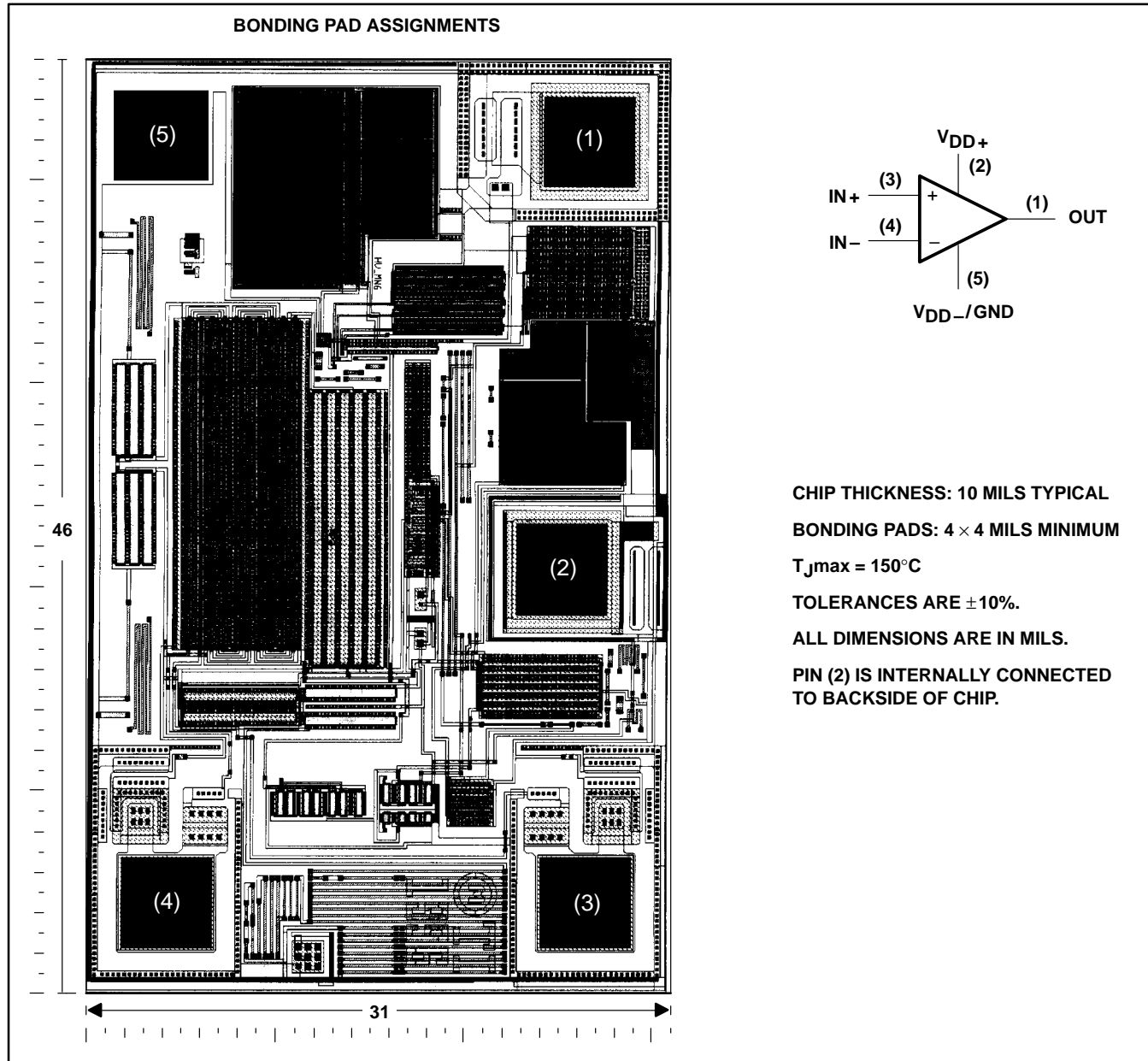

equivalent schematic

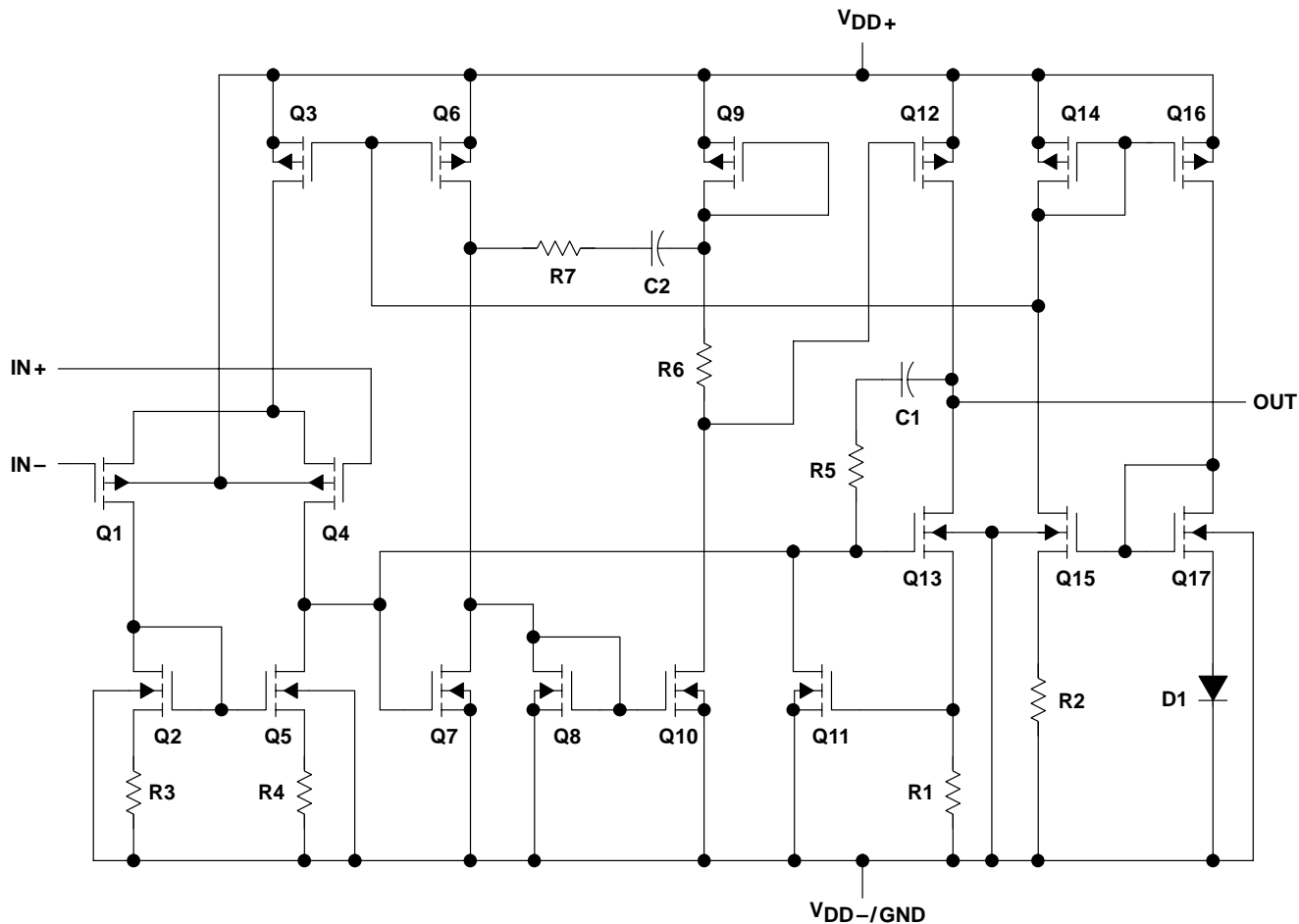

COMPONENT COUNT†	
Transistors	23
Diodes	5
Resistors	11
Capacitors	2

† Includes both amplifiers and all ESD, bias, and trim circuitry

TLV2731, TLV2731Y
Advanced LinCMOS™ RAIL-TO-RAIL
LOW-POWER SINGLE OPERATIONAL AMPLIFIERS

SLOS198A – AUGUST 1997 – REVISED MARCH 2001

absolute maximum ratings over operating free-air temperature range (unless otherwise noted)†

Supply voltage, V_{DD} (see Note 1)	12 V
Differential input voltage, V_{ID} (see Note 2)	$\pm V_{DD}$
Input voltage range, V_I (any input, see Note 1)	-0.3 V to V_{DD}
Input current, I_I (each input)	± 5 mA
Output current, I_O	± 50 mA
Total current into V_{DD+}	± 50 mA
Total current out of V_{DD-}	± 50 mA
Duration of short-circuit current (at or below) 25°C (see Note 3)	unlimited
Continuous total power dissipation	See Dissipation Rating Table
Operating free-air temperature range, T_A : TLV2731C	0°C to 70°C
TLV2731I	-40°C to 85°C
Storage temperature range, T_{stg}	-65°C to 150°C
Lead temperature 1,6 mm (1/16 inch) from case for 10 seconds: DBV package	260°C

† Stresses beyond those listed under “absolute maximum ratings” may cause permanent damage to the device. These are stress ratings only, and functional operation of the device at these or any other conditions beyond those indicated under “recommended operating conditions” is not implied. Exposure to absolute-maximum-rated conditions for extended periods may affect device reliability.

- NOTES: 1. All voltage values, except differential voltages, are with respect to V_{DD-} .
 2. Differential voltages are at the noninverting input with respect to the inverting input. Excessive current flows when input is brought below $V_{DD-} - 0.3$ V.
 3. The output may be shorted to either supply. Temperature and/or supply voltages must be limited to ensure that the maximum dissipation rating is not exceeded.

DISSIPATION RATING TABLE

PACKAGE	$T_A \leq 25^\circ\text{C}$ POWER RATING	DERATING FACTOR ABOVE $T_A = 25^\circ\text{C}$	$T_A = 70^\circ\text{C}$ POWER RATING	$T_A = 85^\circ\text{C}$ POWER RATING
DBV	150 mW	1.2 mW/°C	96 mW	78 mW

recommended operating conditions

	TLV2731C		TLV2731I		UNIT
	MIN	MAX	MIN	MAX	
Supply voltage, V_{DD} (see Note 1)	2.7	10	2.7	10	V
Input voltage range, V_I	V_{DD-}	$V_{DD+} - 1.3$	V_{DD-}	$V_{DD+} - 1.3$	V
Common-mode input voltage, V_{IC}	V_{DD-}	$V_{DD+} - 1.3$	V_{DD-}	$V_{DD+} - 1.3$	V
Operating free-air temperature, T_A	0	70	-40	85	°C

NOTE 1: All voltage values, except differential voltages, are with respect to V_{DD-} .



TLV2731, TLV2731Y
Advanced LinCMOS™ RAIL-TO-RAIL
LOW-POWER SINGLE OPERATIONAL AMPLIFIERS

SLOS198A – AUGUST 1997 – REVISED MARCH 2001

electrical characteristics at specified free-air temperature, $V_{DD} = 3\text{ V}$ (unless otherwise noted)

PARAMETER	TEST CONDITIONS	T_A †	TLV2731C			TLV2731I			UNIT		
			MIN	TYP	MAX	MIN	TYP	MAX			
V_{IO}	Input offset voltage	Full range		0.7	3		0.7	3	mV		
αV_{IO}	Temperature coefficient of input offset voltage			0.5			0.5		$\mu\text{V}/^\circ\text{C}$		
	Input offset voltage long-term drift (see Note 4)		25°C	0.003			0.003			$\mu\text{V}/\text{mo}$	
I_{IO}	Input offset current		25°C	0.5			0.5			pA	
		Full range	150			150					
I_{IB}	Input bias current	25°C	1			1			pA		
		Full range	150			150					
V_{ICR}	Common-mode input voltage range	$R_S = 50\ \Omega$, $ V_{IO} \leq 5\text{ mV}$	25°C	0 to 2	-0.3 to 2.2	0 to 2	-0.3 to 2.2	V			
			Full range	0 to 1.7		0 to 1.7					
V_{OH}	High-level output voltage	$I_{OH} = -1\text{ mA}$	25°C	2.87			2.87			V	
			25°C	2.74			2.74				
			Full range	2.3			2.3				
V_{OL}	Low-level output voltage	$V_{IC} = 1.5\text{ V}$, $I_{OL} = 50\ \mu\text{A}$	25°C	10			10			mV	
			25°C	100			100				
			Full range	300			300				
A_{VD}	Large-signal differential voltage amplification	$V_{IC} = 1.5\text{ V}$, $V_O = 1\text{ V to }2\text{ V}$	$R_L = 600\ \Omega$ ‡	25°C	1	1.6	1	1.6	V/mV		
				Full range	0.3			0.3			
				25°C	250			250			
r_{id}	Differential input resistance		25°C	10^{12}			10^{12}			Ω	
r_{ic}	Common-mode input resistance		25°C	10^{12}			10^{12}			Ω	
c_{ic}	Common-mode input capacitance	$f = 10\text{ kHz}$	25°C	6			6			pF	
z_o	Closed-loop output impedance	$f = 1\text{ MHz}$, $A_V = 1$	25°C	156			156			Ω	
CMRR	Common-mode rejection ratio	$V_{IC} = 0\text{ to }1.7\text{ V}$, $V_O = 1.5\text{ V}$, $R_S = 50\ \Omega$	25°C	60	70	60	70	dB			
			Full range	55			55				
kSVR	Supply voltage rejection ratio ($\Delta V_{DD} / \Delta V_{IO}$)	$V_{DD} = 2.7\text{ V to }8\text{ V}$, $V_{IC} = V_{DD}/2$, No load	25°C	70	96	70	96	dB			
			Full range	70			70				
I_{DD}	Supply current	$V_O = 1.5\text{ V}$, No load	25°C	750	1200	750	1200	μA			
			Full range	1500			1500				

† Full range for the TLV2731C is 0°C to 70°C. Full range for the TLV2731I is -40°C to 85°C.

‡ Referenced to 1.5 V

NOTE 4: Typical values are based on the input offset voltage shift observed through 500 hours of operating life test at $T_A = 150^\circ\text{C}$ extrapolated to $T_A = 25^\circ\text{C}$ using the Arrhenius equation and assuming an activation energy of 0.96 eV.

TLV2731, TLV2731Y
Advanced LinCMOS™ RAIL-TO-RAIL
LOW-POWER SINGLE OPERATIONAL AMPLIFIERS

SLOS198A – AUGUST 1997 – REVISED MARCH 2001

operating characteristics at specified free-air temperature, $V_{DD} = 3\text{ V}$

PARAMETER	TEST CONDITIONS	T_A †	TLV2731C			TLV2731I			UNIT
			MIN	TYP	MAX	MIN	TYP	MAX	
SR	Slew rate at unity gain $V_O = 1.1\text{ V to }1.9\text{ V}, R_L = 600\ \Omega\ddagger, C_L = 100\text{ pF}\ddagger$	25°C	0.75	1.25		0.75	1.25		V/ μs
		Full range	0.5			0.5			
V_n	Equivalent input noise voltage $f = 10\text{ Hz}$ $f = 1\text{ kHz}$	25°C	105			105			nV/ $\sqrt{\text{Hz}}$
		25°C	16			16			
$V_{N(PP)}$	Peak-to-peak equivalent input noise voltage $f = 0.1\text{ Hz to }1\text{ Hz}$ $f = 0.1\text{ Hz to }10\text{ Hz}$	25°C	1.4			1.4			μV
		25°C	1.5			1.5			
I_n	Equivalent input noise current	25°C	0.6			0.6			fA/ $\sqrt{\text{Hz}}$
THD+N	$V_O = 1\text{ V to }2\text{ V}, f = 20\text{ kHz}, R_L = 600\ \Omega\ddagger$	$A_V = 1$	0.285%			0.285%			
		$A_V = 10$	7.2%			7.2%			
	$V_O = 1\text{ V to }2\text{ V}, f = 20\text{ kHz}, R_L = 600\ \Omega\§$	$A_V = 1$	0.014%			0.014%			
		$A_V = 10$	0.098%			0.098%			
		$A_V = 100$	0.13%			0.13%			
Gain-bandwidth product	$f = 10\text{ kHz}, R_L = 600\ \Omega\ddagger, C_L = 100\text{ pF}\ddagger$	25°C	1.9			1.9			MHz
BOM	Maximum output-swing bandwidth $V_{O(PP)} = 1\text{ V}, R_L = 600\ \Omega\ddagger, A_V = 1, C_L = 100\text{ pF}\ddagger$	25°C	60			60			kHz
t_s	Settling time $A_V = -1, \text{ Step} = 1\text{ V to }2\text{ V}, R_L = 600\ \Omega\ddagger, C_L = 100\text{ pF}\ddagger$	To 0.1%	0.9			0.9			μs
		To 0.01%	1.5			1.5			
ϕ_m	Phase margin at unity gain $R_L = 600\ \Omega\ddagger, C_L = 100\text{ pF}\ddagger$	25°C	50°			50°			
		25°C	8			8			
	Gain margin	25°C	8			8			dB

† Full range is -40°C to 85°C .

‡ Referenced to 1.5 V

§ Referenced to 0 V



electrical characteristics at specified free-air temperature, $V_{DD} = 5\text{ V}$ (unless otherwise noted)

PARAMETER	TEST CONDITIONS	T_A †	TLV2731C			TLV2731I			UNIT
			MIN	TYP	MAX	MIN	TYP	MAX	
V_{IO} Input offset voltage	$V_{DD} = \pm 2.5\text{ V}$, $V_O = 0$, $V_{IC} = 0$, $R_S = 50\ \Omega$	Full range	0.7		3	0.7		3	mV
$\alpha_{V_{IO}}$ Temperature coefficient of input offset voltage			0.5		0.5		$\mu\text{V}/^\circ\text{C}$		
Input offset voltage long-term drift (see Note 4)		25°C	0.003		0.003		$\mu\text{V}/\text{mo}$		
I_{IO} Input offset current		25°C	0.5	60	0.5	60	pA		
		Full range	150		150				
I_{IB} Input bias current	25°C	1	60	1	60	pA			
	Full range	150		150					
V_{ICR} Common-mode input voltage range	$R_S = 50\ \Omega$, $ V_{IO} \leq 5\text{ mV}$	25°C	0 to 4	-0.3 to 4.2	0 to 4	-0.3 to 4.2	V		
		Full range	0 to 3.7		0 to 3.7				
V_{OH} High-level output voltage	$I_{OH} = -1\text{ mA}$	25°C	4.9		4.9		V		
		25°C	4.6		4.6				
		Full range	4.3		4.3				
V_{OL} Low-level output voltage	$V_{IC} = 2.5\text{ V}$, $I_{OL} = 500\ \mu\text{A}$	25°C	80		80		mV		
		25°C	160		160				
		Full range	500		500				
A_{VD} Large-signal differential voltage amplification	$V_{IC} = 2.5\text{ V}$, $V_O = 1\text{ V to }4\text{ V}$	25°C	$R_L = 600\ \Omega$ ‡		1 1.5		V/mV		
			Full range		0.3				
		25°C	$R_L = 1\text{ M}\Omega$ ‡		400				
r_{id} Differential input resistance		25°C	10^{12}		10^{12}		Ω		
r_{ic} Common-mode input resistance		25°C	10^{12}		10^{12}		Ω		
c_{ic} Common-mode input capacitance	$f = 10\text{ kHz}$	25°C	6		6		pF		
z_o Closed-loop output impedance	$f = 1\text{ MHz}$, $A_V = 1$	25°C	138		138		Ω		
CMRR Common-mode rejection ratio	$V_{IC} = 0\text{ to }2.7\text{ V}$, $V_O = 2.5\text{ V}$, $R_S = 50\ \Omega$	25°C	60	70	60	70	dB		
		Full range	55		55				
k_{SVR} Supply voltage rejection ratio ($\Delta V_{DD} / \Delta V_{IO}$)	$V_{DD} = 4.4\text{ V to }8\text{ V}$, $V_{IC} = V_{DD}/2$, No load	25°C	70	96	70	96	dB		
		Full range	70		70				
I_{DD} Supply current	$V_O = 2.5\text{ V}$, No load	25°C	850	1300	850	1300	μA		
		Full range	1600		1600				

† Full range for the TLV2731C is 0°C to 70°C. Full range for the TLV2731I is -40°C to 85°C.

‡ Referenced to 2.5 V

NOTE 5: Typical values are based on the input offset voltage shift observed through 500 hours of operating life test at $T_A = 150^\circ\text{C}$ extrapolated to $T_A = 25^\circ\text{C}$ using the Arrhenius equation and assuming an activation energy of 0.96 eV.

TLV2731, TLV2731Y
Advanced LinCMOS™ RAIL-TO-RAIL
LOW-POWER SINGLE OPERATIONAL AMPLIFIERS

SLOS198A – AUGUST 1997 – REVISED MARCH 2001

operating characteristics at specified free-air temperature, $V_{DD} = 5\text{ V}$

PARAMETER	TEST CONDITIONS	T_A †	TLV2731C			TLV2731I			UNIT
			MIN	TYP	MAX	MIN	TYP	MAX	
SR	Slew rate at unity gain $V_O = 1.5\text{ V to }3.5\text{ V},$ $R_L = 600\ \Omega\ddagger,$ $C_L = 100\text{ pF}\ddagger$	25°C	1	1.6		1	1.6	V/ μs	
		Full range	0.7			0.7			
V_n	Equivalent input noise voltage $f = 10\text{ Hz}$ $f = 1\text{ kHz}$	25°C		100			100	nV/ $\sqrt{\text{Hz}}$	
		25°C		15			15		
$V_{N(PP)}$	Peak-to-peak equivalent input noise voltage $f = 0.1\text{ Hz to }1\text{ Hz}$ $f = 0.1\text{ Hz to }10\text{ Hz}$	25°C		1.4			1.4	μV	
		25°C		1.5			1.5		
I_n	Equivalent input noise current	25°C		0.6			0.6	fA/ $\sqrt{\text{Hz}}$	
THD+N	Total harmonic distortion plus noise $V_O = 1.5\text{ V to }3.5\text{ V},$ $f = 20\text{ kHz},$ $R_L = 600\ \Omega\ddagger$ $V_O = 1.5\text{ V to }3.5\text{ V},$ $f = 20\text{ kHz},$ $R_L = 600\ \Omega\§$	25°C	$A_V = 1$	0.409%			0.409%		
			$A_V = 10$	3.68%			3.68%		
		25°C	$A_V = 1$	0.018%			0.018%		
			$A_V = 10$	0.045%			0.045%		
			$A_V = 100$	0.116%			0.116%		
Gain-bandwidth product	$f = 10\text{ kHz},$ $C_L = 100\text{ pF}\ddagger$	$R_L = 600\ \Omega\ddagger,$	25°C		2		2	MHz	
B_{OM}	Maximum output-swing bandwidth $V_{O(PP)} = 1\text{ V},$ $R_L = 600\ \Omega\ddagger,$	$A_V = 1,$ $C_L = 100\text{ pF}\ddagger$	25°C		300		300	kHz	
t_s	Settling time $A_V = -1,$ Step = 1.5 V to 3.5 V, $R_L = 600\ \Omega\ddagger,$ $C_L = 100\text{ pF}\ddagger$	To 0.1%	25°C		0.95		0.95	μs	
		To 0.01%			2.4		2.4		
ϕ_m	Phase margin at unity gain $R_L = 600\ \Omega\ddagger,$	$C_L = 100\text{ pF}\ddagger$	25°C		48°		48°		
			25°C		8		8		
	Gain margin		25°C		8		8	dB	

† Full range is -40°C to 85°C .

‡ Referenced to 2.5 V

§ Referenced to 0 V



electrical characteristics at $V_{DD} = 3\text{ V}$, $T_A = 25^\circ\text{C}$ (unless otherwise noted)

PARAMETER	TEST CONDITIONS	TLV2731Y			UNIT
		MIN	TYP	MAX	
V_{IO} Input offset voltage	$V_{DD} \pm = \pm 1.5\text{ V}$, $V_{IC} = 0$, $V_O = 0$, $R_S = 50\ \Omega$	750			μV
I_{IO} Input offset current		0.5	60	pA	
I_{IB} Input bias current		1	60	pA	
V_{ICR} Common-mode input voltage range	$ V_{IO} \leq 5\text{ mV}$, $R_S = 50\ \Omega$	-0.3 to 2.2			V
V_{OH} High-level output voltage	$I_{OH} = -1\text{ mA}$	2.87			V
V_{OL} Low-level output voltage	$V_{IC} = 1.5\text{ V}$, $I_{OL} = 50\ \mu\text{A}$	10			mV
	$V_{IC} = 1.5\text{ V}$, $I_{OL} = 500\ \mu\text{A}$	100			
A_{VD} Large-signal differential voltage amplification	$V_O = 1\text{ V to }2\text{ V}$	$R_L = 600\ \Omega^\dagger$	1.6		V/mV
		$R_L = 1\ \text{M}\Omega^\dagger$	250		
r_{id} Differential input resistance		10^{12}			Ω
r_{ic} Common-mode input resistance		10^{12}			Ω
c_{ic} Common-mode input capacitance	$f = 10\text{ kHz}$	6			pF
z_o Closed-loop output impedance	$f = 1\text{ MHz}$, $A_V = 1$	156			Ω
CMRR Common-mode rejection ratio	$V_{IC} = 0\text{ to }1.7\text{ V}$, $V_O = 0$, $R_S = 50\ \Omega$	70			dB
k_{SVR} Supply voltage rejection ratio ($\Delta V_{DD}/\Delta V_{IO}$)	$V_{DD} = 2.7\text{ V to }8\text{ V}$, $V_{IC} = 0$, No load	96			dB
I_{DD} Supply current	$V_O = 0$, No load	750			μA

† Referenced to 1.5 V

electrical characteristics at $V_{DD} = 5\text{ V}$, $T_A = 25^\circ\text{C}$ (unless otherwise noted)

PARAMETER	TEST CONDITIONS	TLV2731Y			UNIT
		MIN	TYP	MAX	
V_{IO} Input offset voltage	$V_{DD} \pm = \pm 1.5\text{ V}$, $V_{IC} = 0$, $V_O = 0$, $R_S = 50\ \Omega$	710			μV
I_{IO} Input offset current		0.5	60	pA	
I_{IB} Input bias current		1	60	pA	
V_{ICR} Common-mode input voltage range	$ V_{IO} \leq 5\text{ mV}$, $R_S = 50\ \Omega$	-0.3 to 4.2			V
V_{OH} High-level output voltage	$I_{OH} = -1\text{ mA}$	4.9			V
V_{OL} Low-level output voltage	$V_{IC} = 2.5\text{ V}$, $I_{OL} = 500\ \mu\text{A}$	80			mV
	$V_{IC} = 2.5\text{ V}$, $I_{OL} = 1\text{ mA}$	160			
A_{VD} Large-signal differential voltage amplification	$V_O = 1\text{ V to }2\text{ V}$	$R_L = 600\ \Omega^\dagger$	15		V/mV
		$R_L = 1\ \text{M}\Omega^\dagger$	400		
r_{id} Differential input resistance		10^{12}			Ω
r_{ic} Common-mode input resistance		10^{12}			Ω
c_{ic} Common-mode input capacitance	$f = 10\text{ kHz}$	6			pF
z_o Closed-loop output impedance	$f = 1\text{ MHz}$, $A_V = 1$	138			Ω
CMRR Common-mode rejection ratio	$V_{IC} = 0\text{ to }1.7\text{ V}$, $V_O = 0$, $R_S = 50\ \Omega$	70			dB
k_{SVR} Supply voltage rejection ratio ($\Delta V_{DD}/\Delta V_{IO}$)	$V_{DD} = 2.7\text{ V to }8\text{ V}$, $V_{IC} = 0$, No load	96			dB
I_{DD} Supply current	$V_O = 0$, No load	850			μA

† Referenced to 2.5 V

TLV2731, TLV2731Y
Advanced LinCMOS™ RAIL-TO-RAIL
LOW-POWER SINGLE OPERATIONAL AMPLIFIERS
 SLOS198A – AUGUST 1997 – REVISED MARCH 2001

TYPICAL CHARACTERISTICS

Table of Graphs

		FIGURE
V_{IO}	Input offset voltage	Distribution vs Common-mode input voltage 1, 2 3, 4
α_{VIO}	Input offset voltage temperature coefficient	Distribution 5, 6
I_{IB}/I_{IO}	Input bias and input offset currents	vs Free-air temperature 7
V_I	Input voltage	vs Supply voltage vs Free-air temperature 8 9
V_{OH}	High-level output voltage	vs High-level output current 10, 13
V_{OL}	Low-level output voltage	vs Low-level output current 11, 12, 14
$V_{O(PP)}$	Maximum peak-to-peak output voltage	vs Frequency 15
I_{OS}	Short-circuit output current	vs Supply voltage vs Free-air temperature 16 17
V_O	Output voltage	vs Differential input voltage 18, 19
A_{VD}	Differential voltage amplification	vs Load resistance 20
A_{VD}	Large-signal differential voltage amplification	vs Frequency vs Free-air temperature 21, 22 23, 24
z_o	Output impedance	vs Frequency 25, 26
$CMRR$	Common-mode rejection ratio	vs Frequency vs Free-air temperature 27 28
k_{SVR}	Supply-voltage rejection ratio	vs Frequency vs Free-air temperature 29, 30 31
I_{DD}	Supply current	vs Supply voltage 32
SR	Slew rate	vs Load capacitance vs Free-air temperature 33 34
V_O	Inverting large-signal pulse response	35, 36
V_O	Voltage-follower large-signal pulse response	37, 38
V_O	Inverting small-signal pulse response	39, 40
V_O	Voltage-follower small-signal pulse response	41, 42
V_n	Equivalent input noise voltage	vs Frequency 43, 44
	Noise voltage (referred to input)	Over a 10-second period 45
$THD + N$	Total harmonic distortion plus noise	vs Frequency 46
	Gain-bandwidth product	vs Free-air temperature vs Supply voltage 47 48
	Gain margin	vs Load capacitance 49, 50
ϕ_m	Phase margin	vs Frequency vs Load capacitance 21, 22 51, 52
B_1	Unity-gain bandwidth	vs Load capacitance 53, 54



TYPICAL CHARACTERISTICS

**DISTRIBUTION OF TLV2731
INPUT OFFSET VOLTAGE**

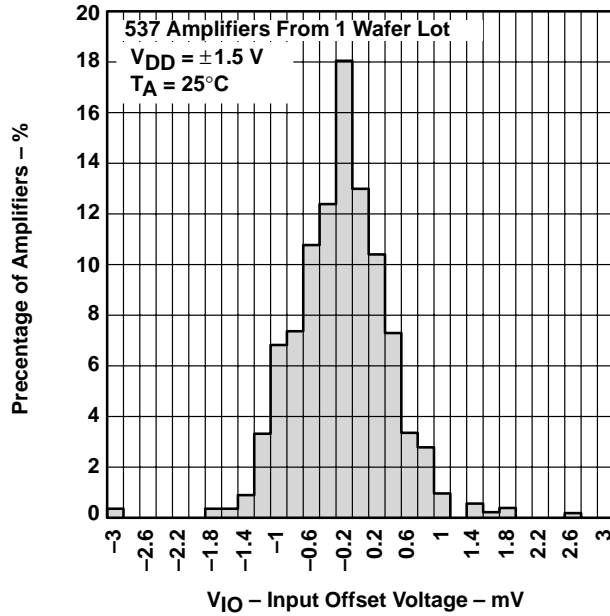

**DISTRIBUTION OF TLV2731
INPUT OFFSET VOLTAGE**

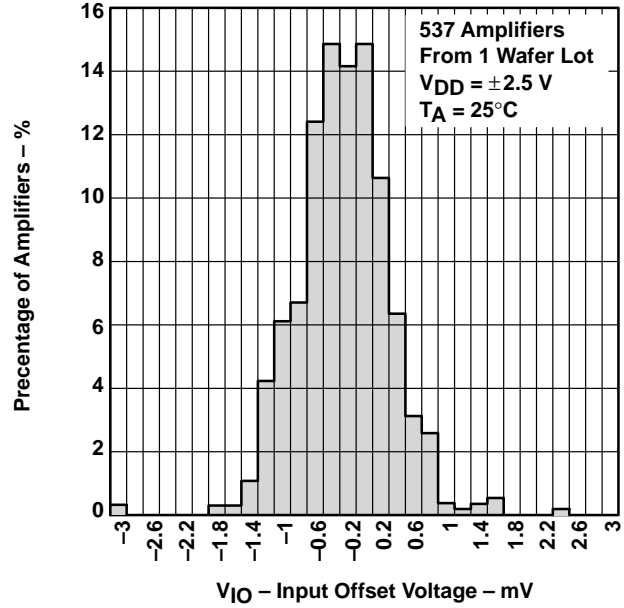

**INPUT OFFSET VOLTAGE†
vs
COMMON-MODE INPUT VOLTAGE**

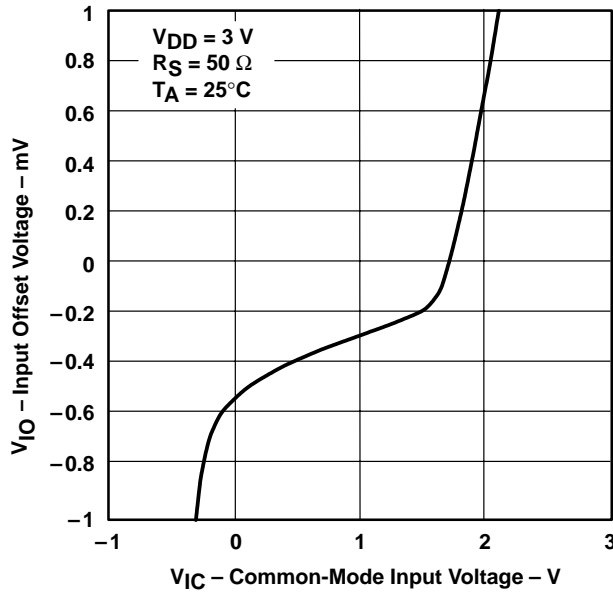

**INPUT OFFSET VOLTAGE†
vs
COMMON-MODE INPUT VOLTAGE**

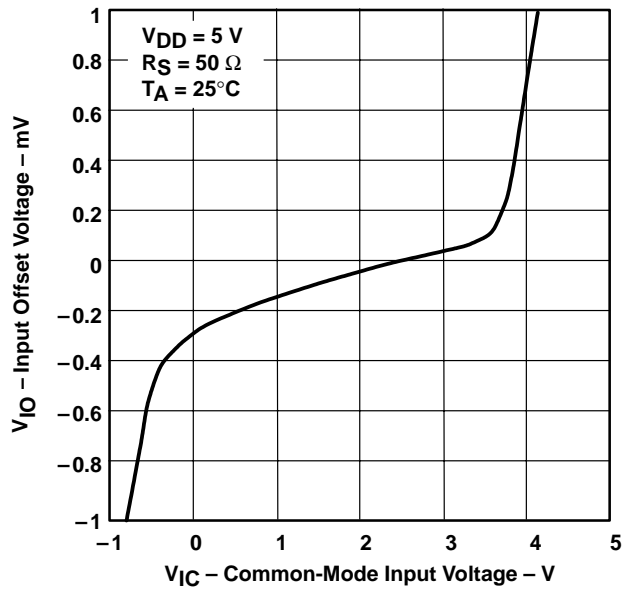

† For all curves where $V_{DD} = 5\text{ V}$, all loads are referenced to 2.5 V. For all curves where $V_{DD} = 3\text{ V}$, all loads are referenced to 1.5 V.

TYPICAL CHARACTERISTICS

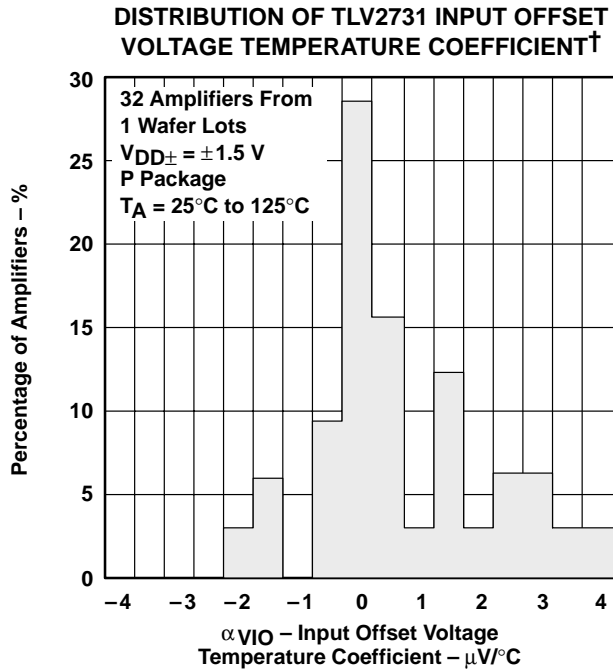

Figure 5

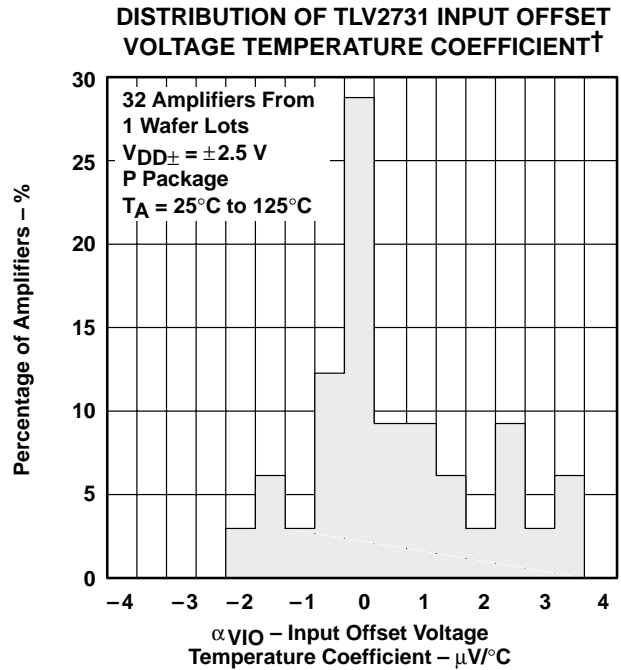

Figure 6

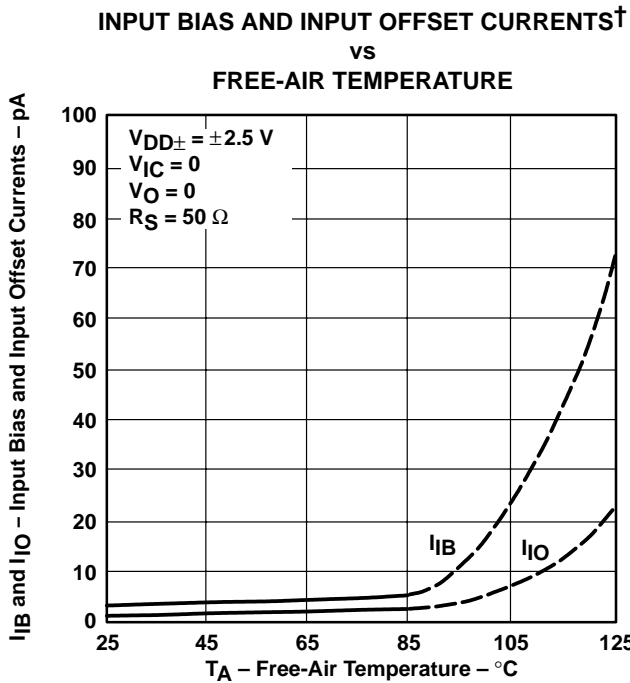

Figure 7

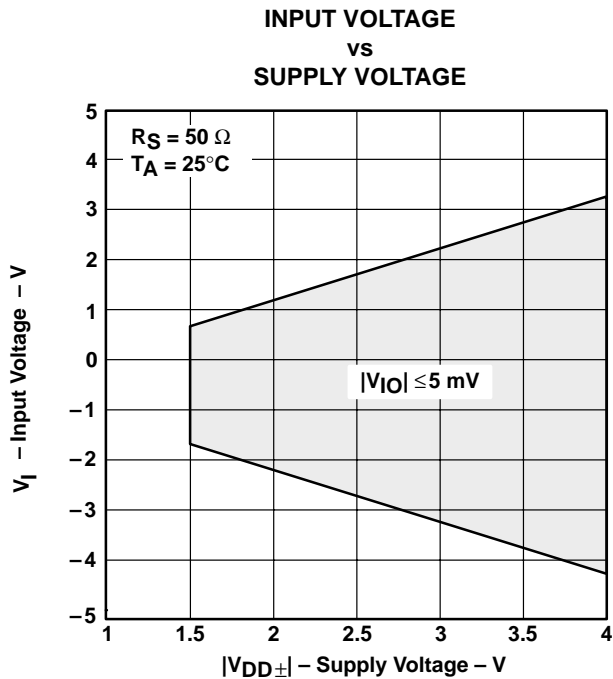

Figure 8

† Data at high and low temperatures are applicable only within the rated operating free-air temperature ranges of the various devices.

TYPICAL CHARACTERISTICS

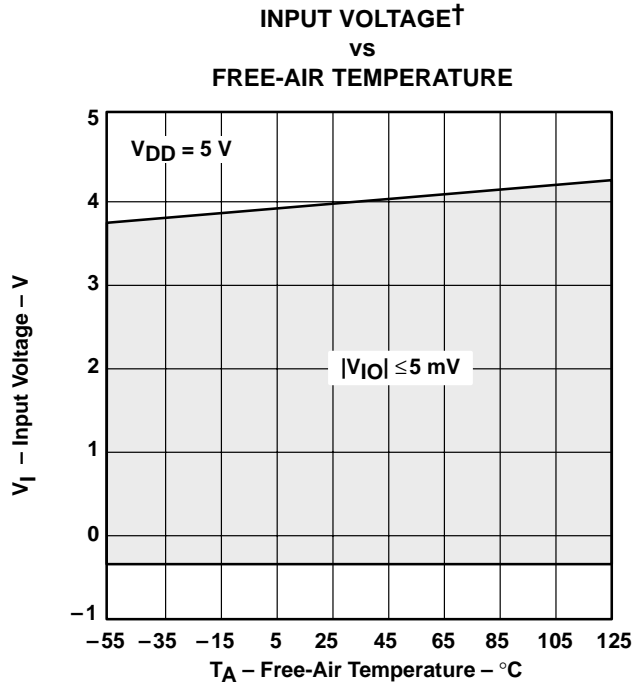

Figure 9

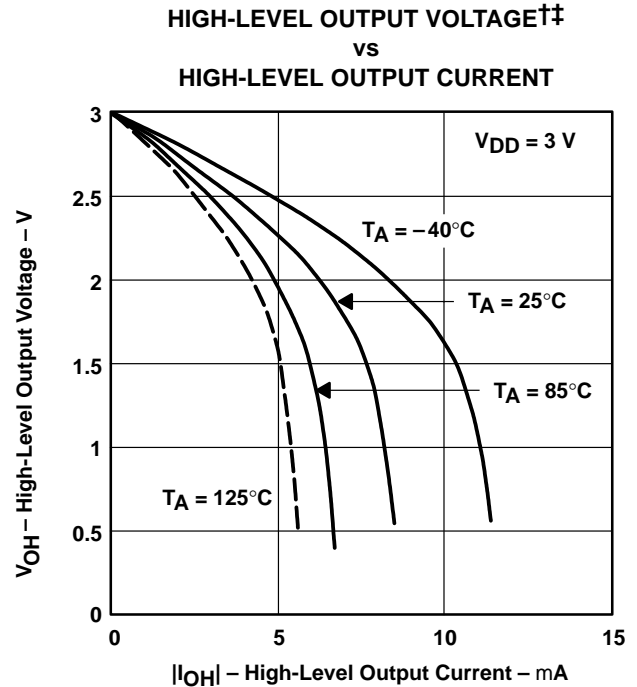

Figure 10

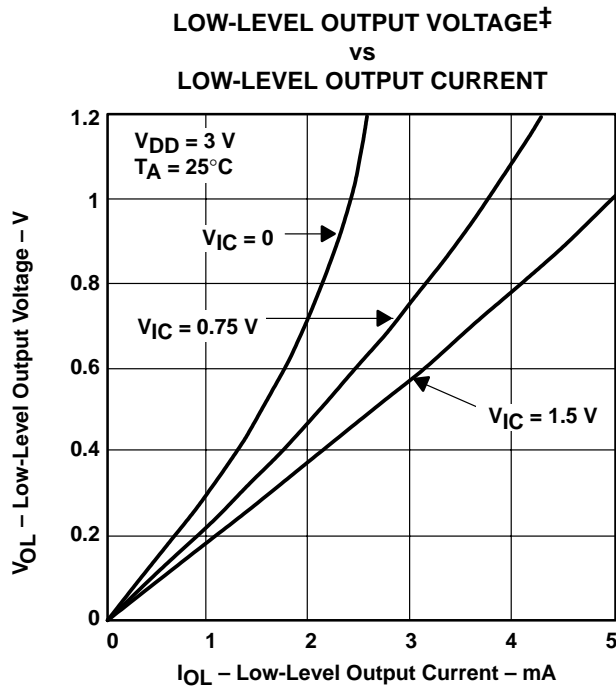

Figure 11

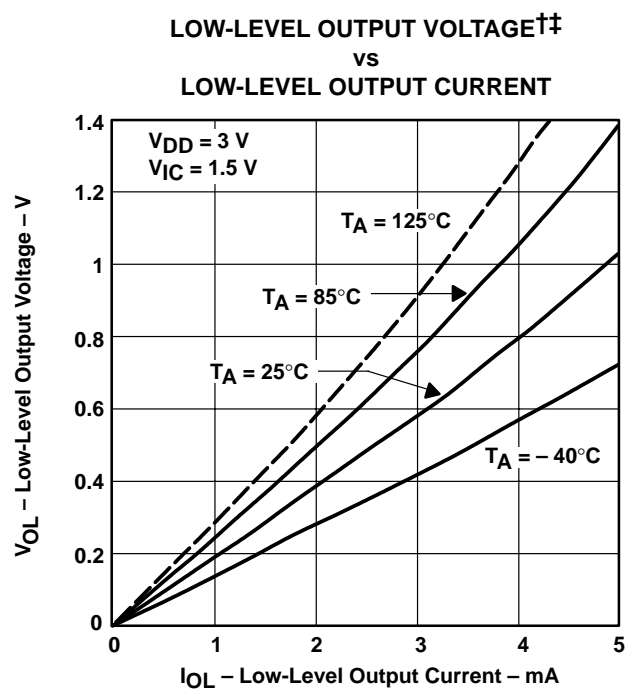

Figure 12

† Data at high and low temperatures are applicable only within the rated operating free-air temperature ranges of the various devices.

‡ For all curves where $V_{DD} = 5\text{ V}$, all loads are referenced to 2.5 V. For all curves where $V_{DD} = 3\text{ V}$, all loads are referenced to 1.5 V.

TYPICAL CHARACTERISTICS

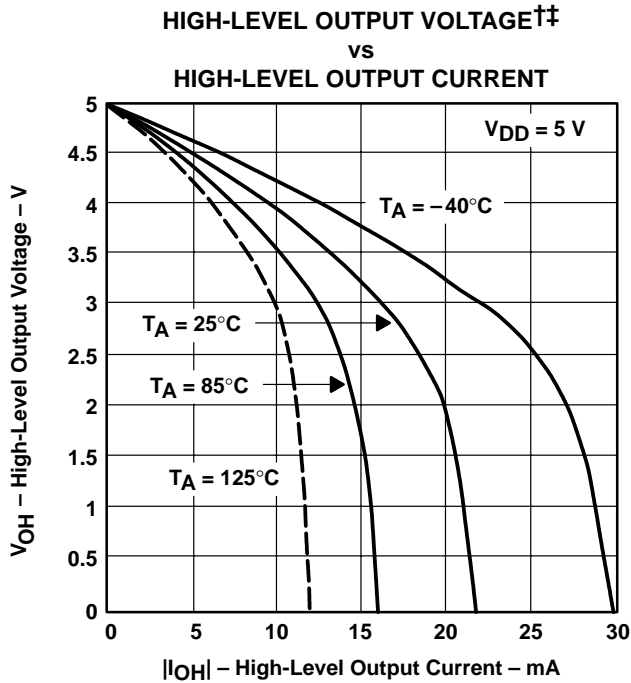

Figure 13

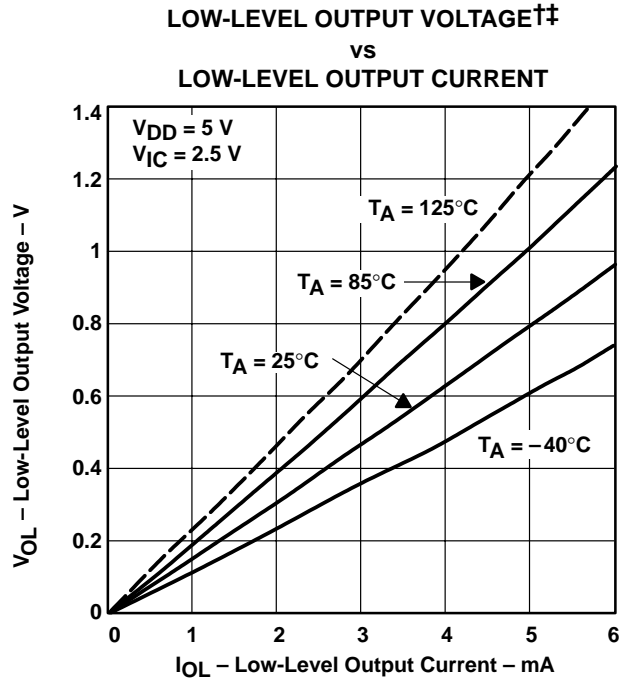

Figure 14

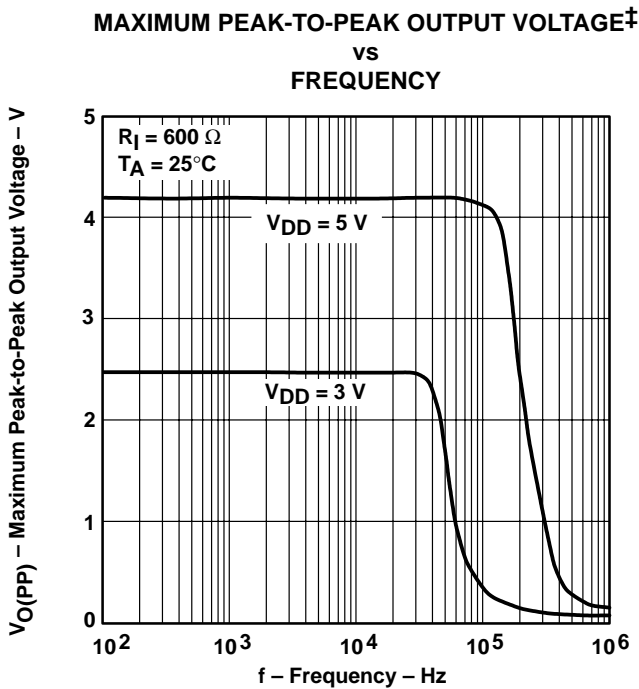

Figure 15

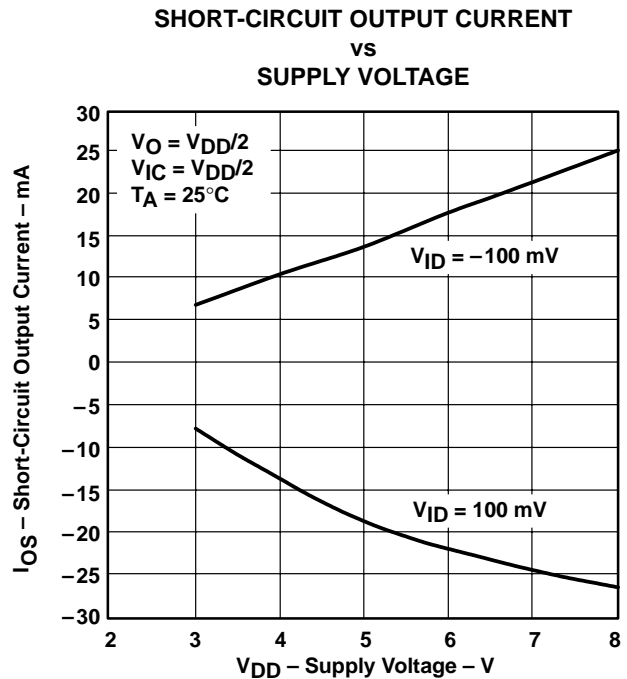

Figure 16

† Data at high and low temperatures are applicable only within the rated operating free-air temperature ranges of the various devices.
 ‡ For all curves where $V_{DD} = 5\text{ V}$, all loads are referenced to 2.5 V. For all curves where $V_{DD} = 3\text{ V}$, all loads are referenced to 1.5 V.

TYPICAL CHARACTERISTICS

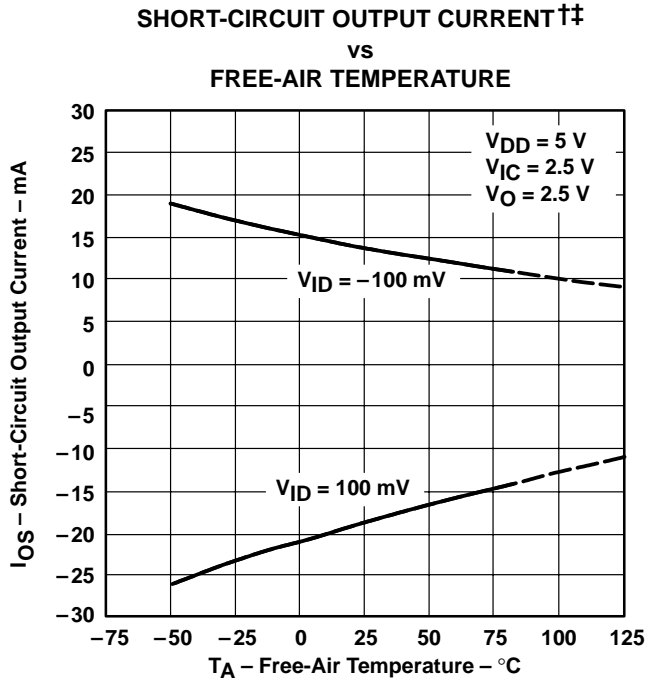

Figure 17

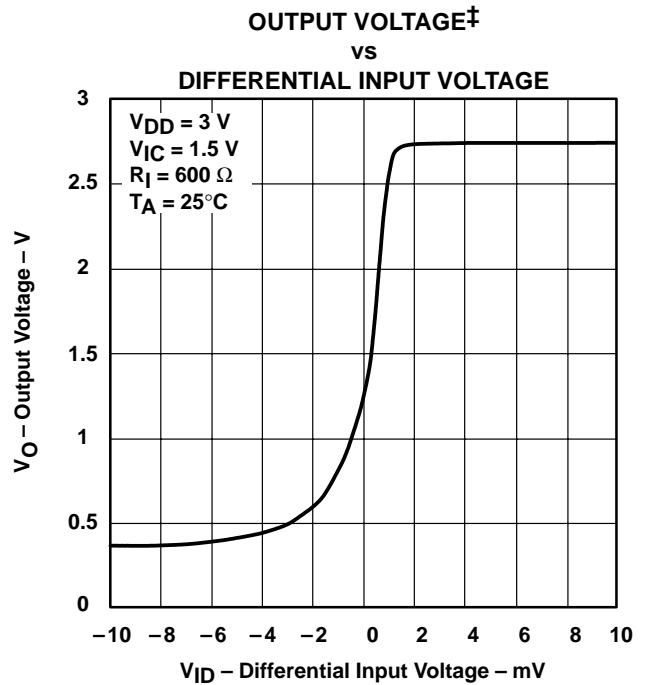

Figure 18

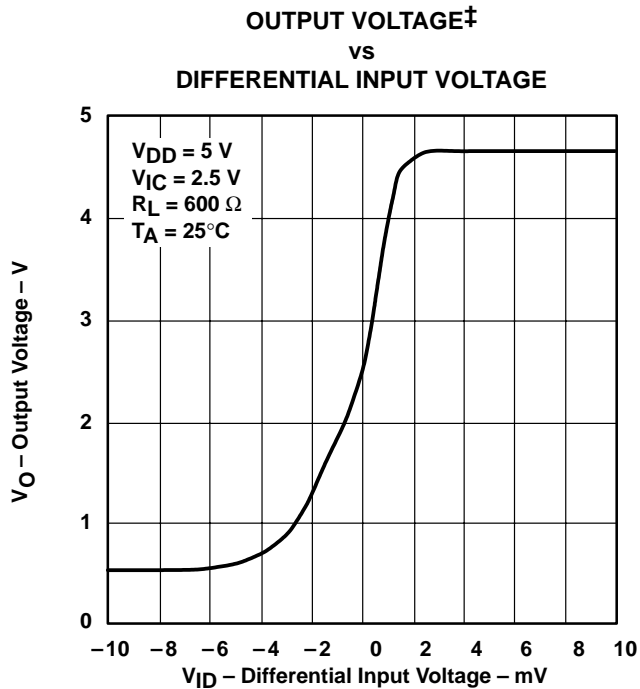

Figure 19

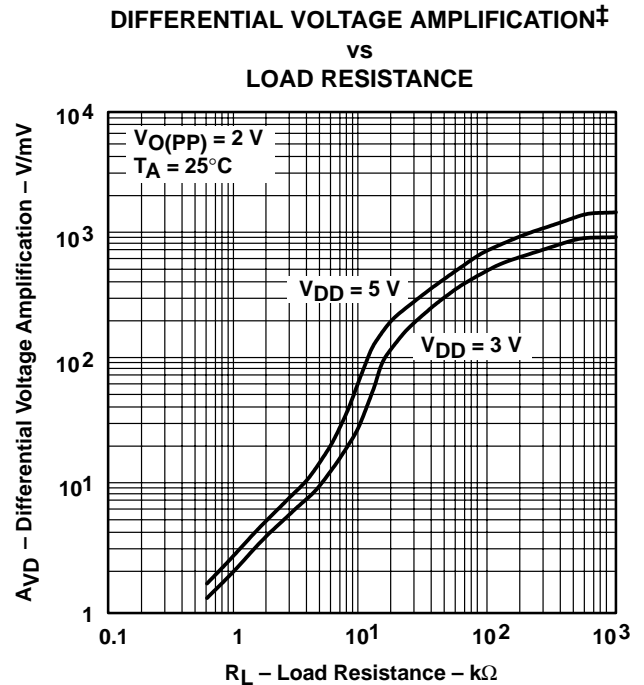

Figure 20

† Data at high and low temperatures are applicable only within the rated operating free-air temperature ranges of the various devices.
 †† For all curves where $V_{DD} = 5\text{ V}$, all loads are referenced to 2.5 V. For all curves where $V_{DD} = 3\text{ V}$, all loads are referenced to 1.5 V.

TYPICAL CHARACTERISTICS

LARGE-SIGNAL DIFFERENTIAL VOLTAGE
 AMPLIFICATION AND PHASE MARGIN†

vs
 FREQUENCY

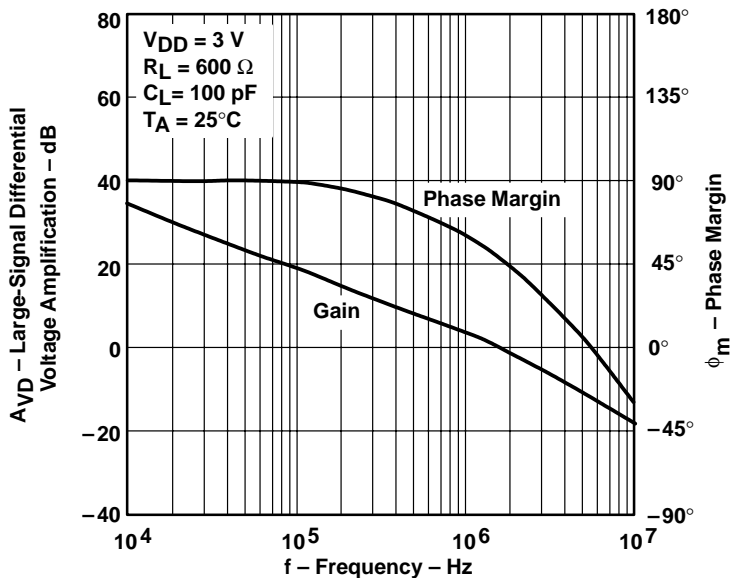

Figure 21

LARGE-SIGNAL DIFFERENTIAL VOLTAGE
 AMPLIFICATION AND PHASE MARGIN†

vs
 FREQUENCY

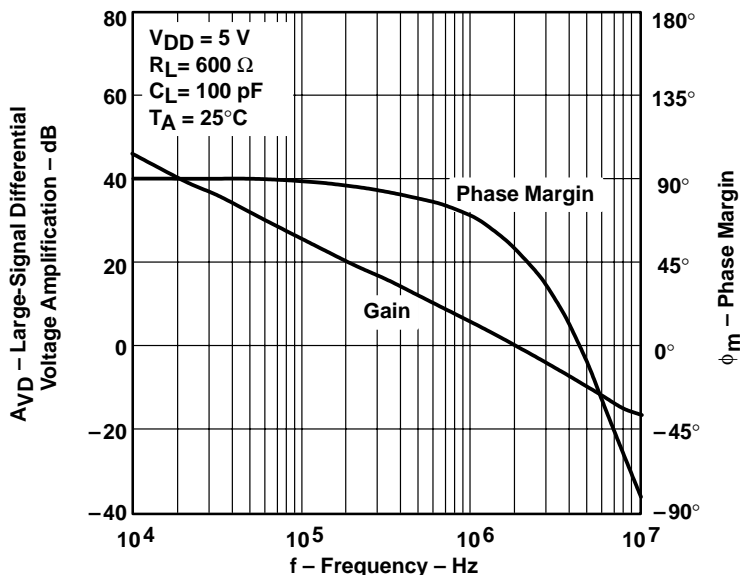
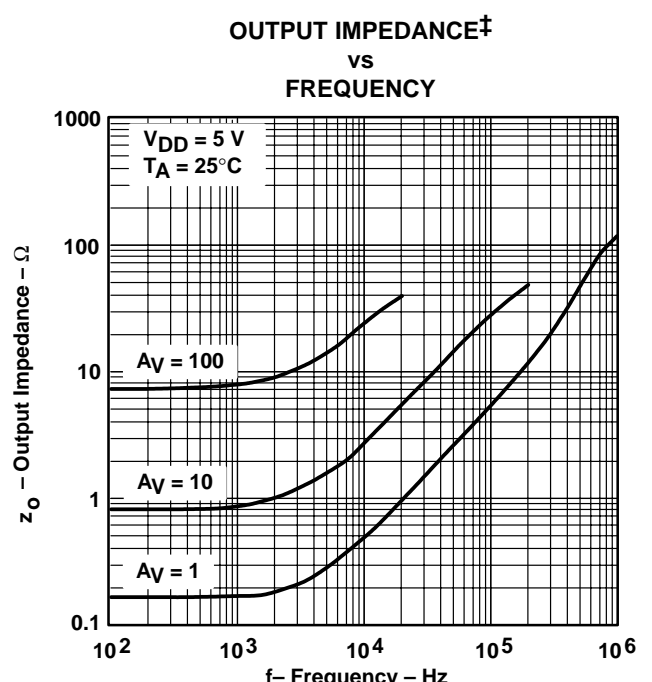
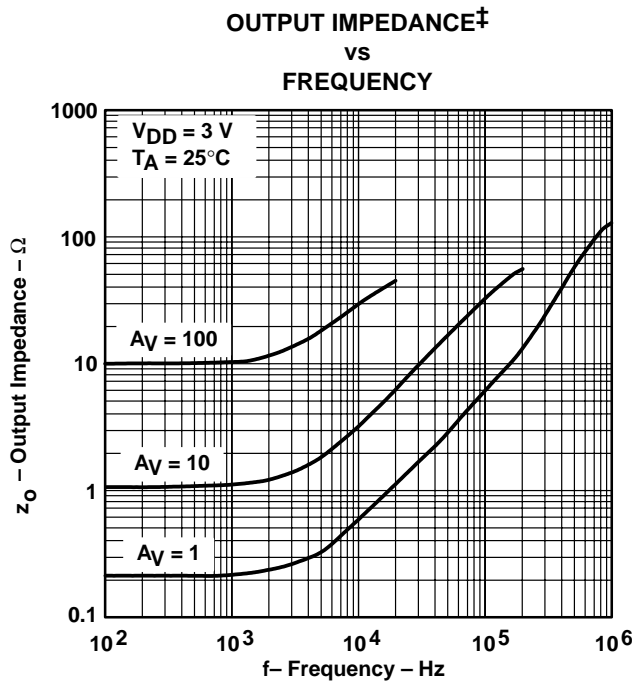
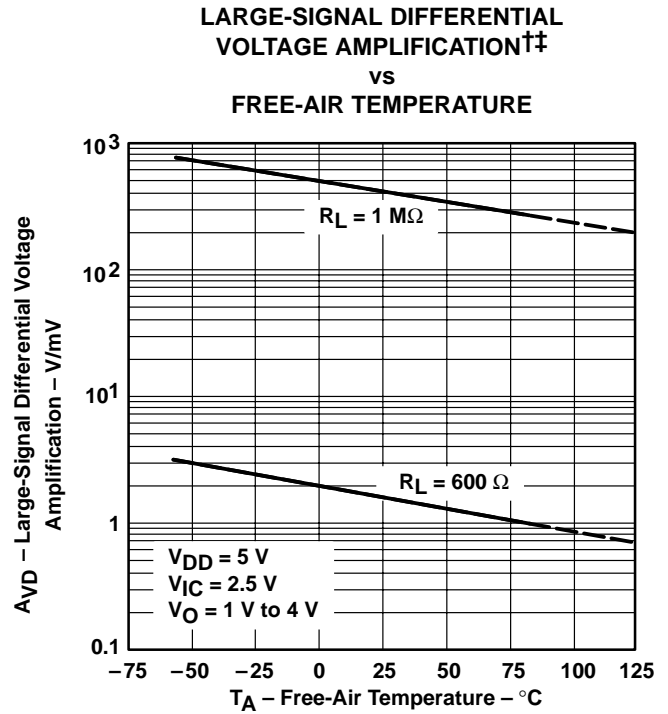
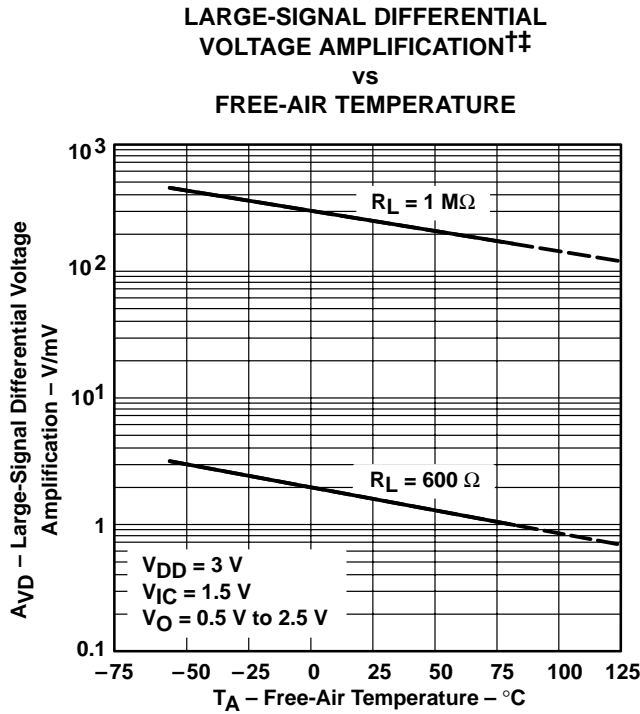

Figure 22

† For all curves where $V_{DD} = 5\text{ V}$, all loads are referenced to 2.5 V. For all curves where $V_{DD} = 3\text{ V}$, all loads are referenced to 1.5 V.

TYPICAL CHARACTERISTICS



† Data at high and low temperatures are applicable only within the rated operating free-air temperature ranges of the various devices.
 ‡ For all curves where $V_{DD} = 5\text{ V}$, all loads are referenced to 2.5 V. For all curves where $V_{DD} = 3\text{ V}$, all loads are referenced to 1.5 V.

TYPICAL CHARACTERISTICS

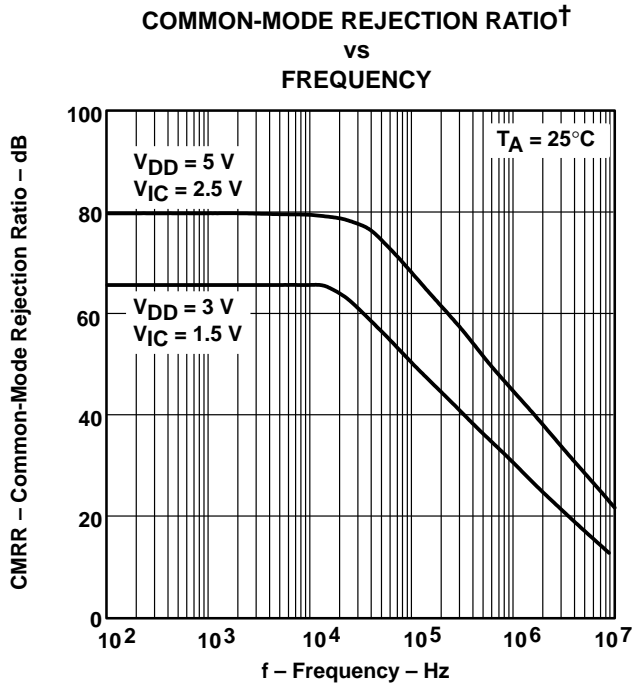

Figure 27

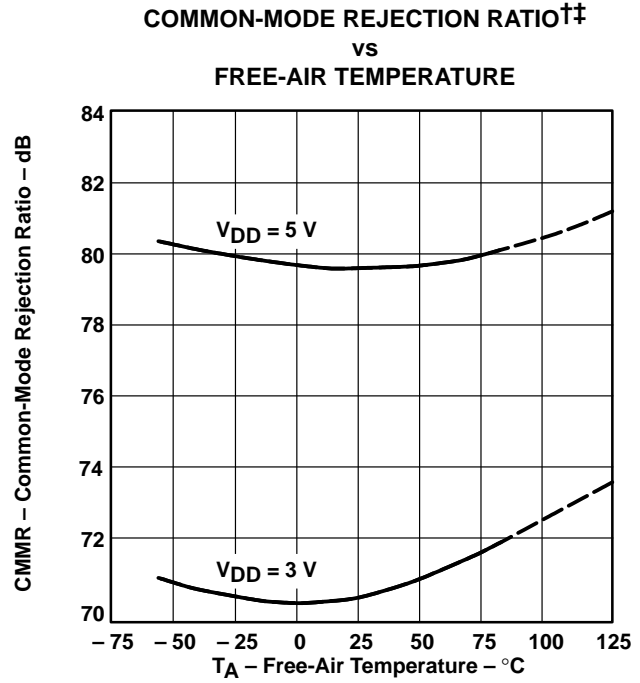

Figure 28

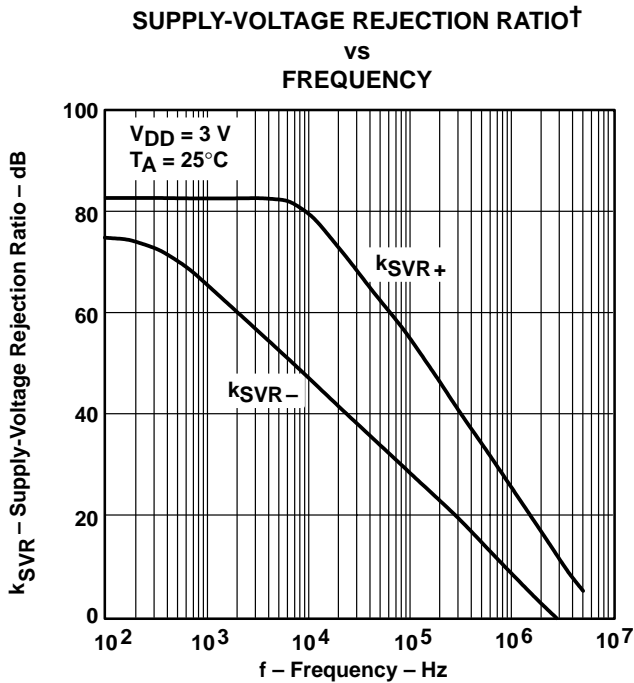

Figure 29

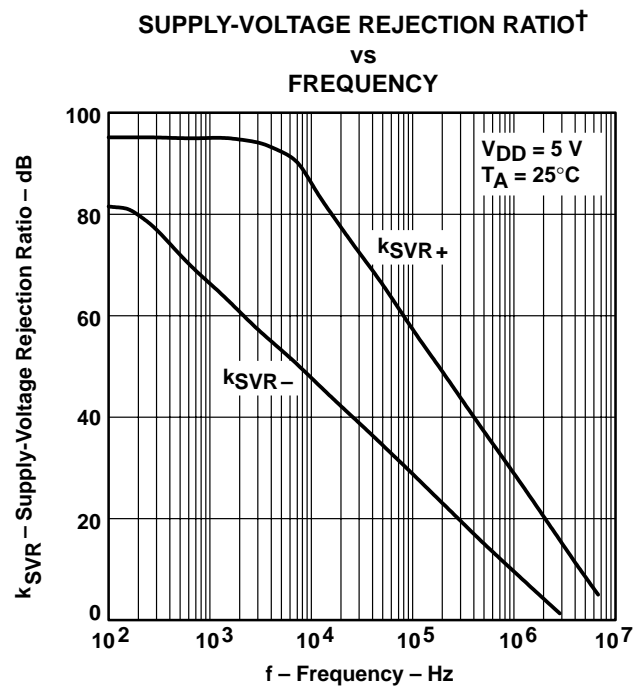
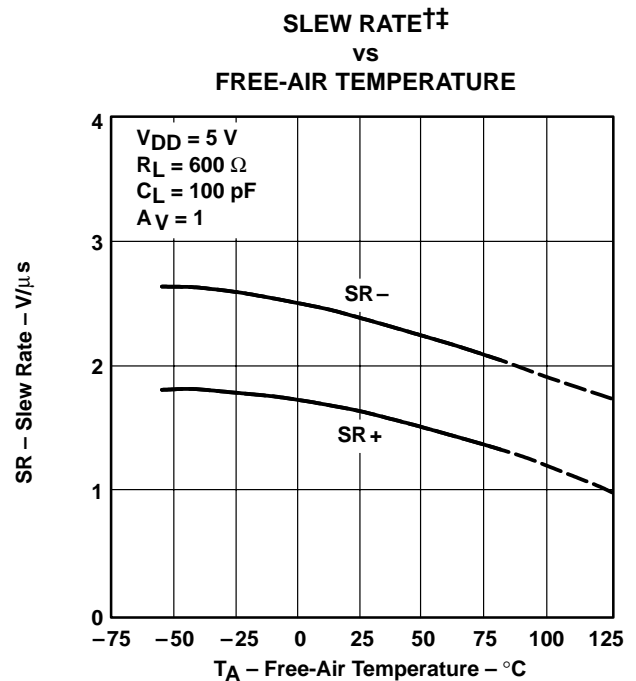
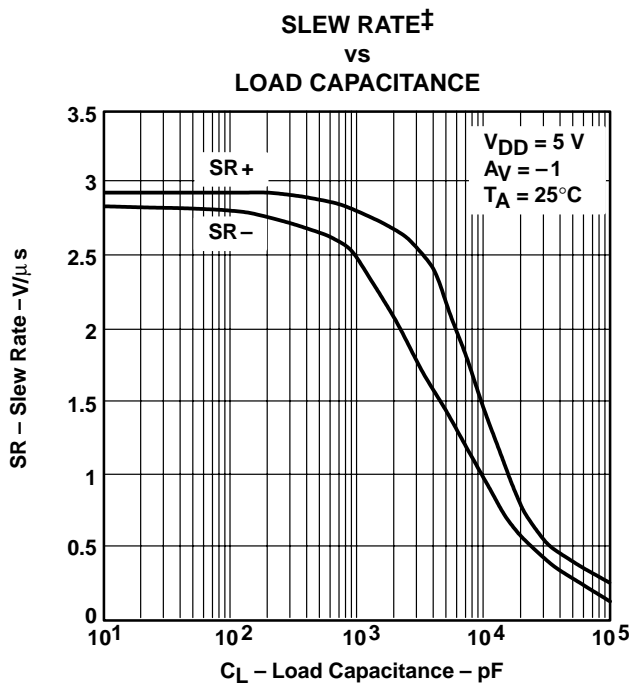
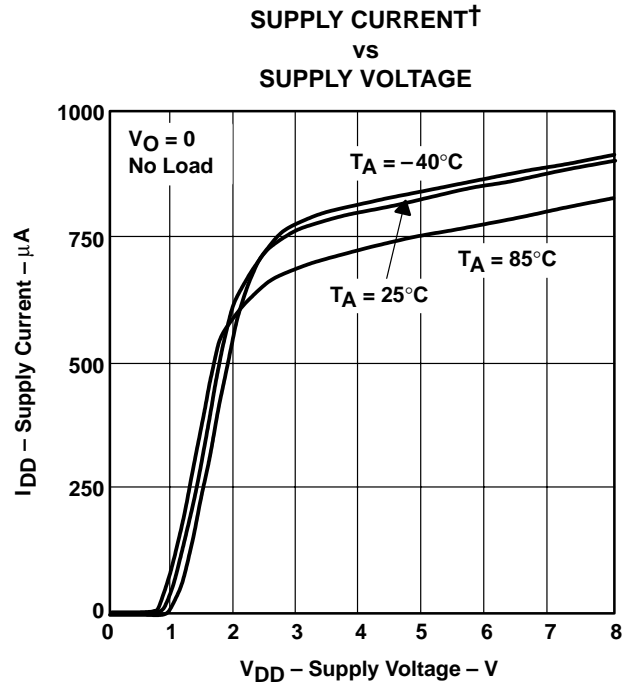
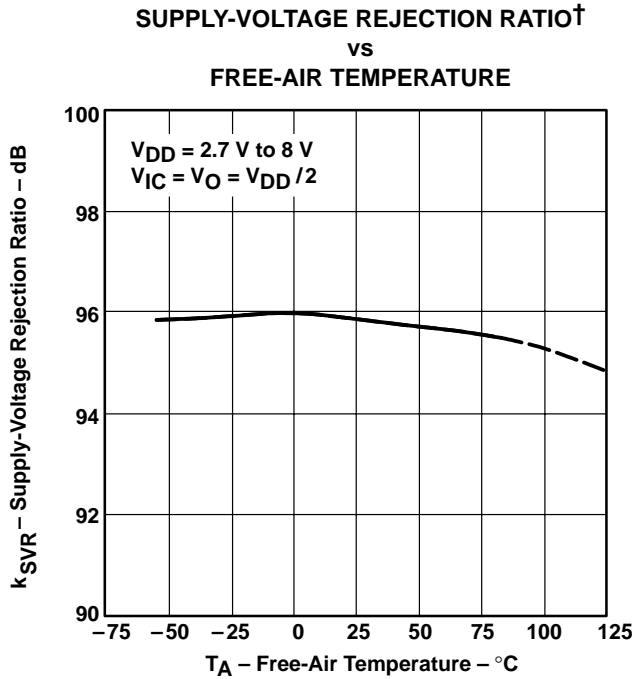

Figure 30

† For all curves where $V_{DD} = 5\text{ V}$, all loads are referenced to 2.5 V. For all curves where $V_{DD} = 3\text{ V}$, all loads are referenced to 1.5 V.
 ‡ Data at high and low temperatures are applicable only within the rated operating free-air temperature ranges of the various devices.

TYPICAL CHARACTERISTICS



† Data at high and low temperatures are applicable only within the rated operating free-air temperature ranges of the various devices.
 ‡ For all curves where $V_{DD} = 5\text{ V}$, all loads are referenced to 2.5 V. For all curves where $V_{DD} = 3\text{ V}$, all loads are referenced to 1.5 V.

TYPICAL CHARACTERISTICS

INVERTING LARGE-SIGNAL PULSE RESPONSE†

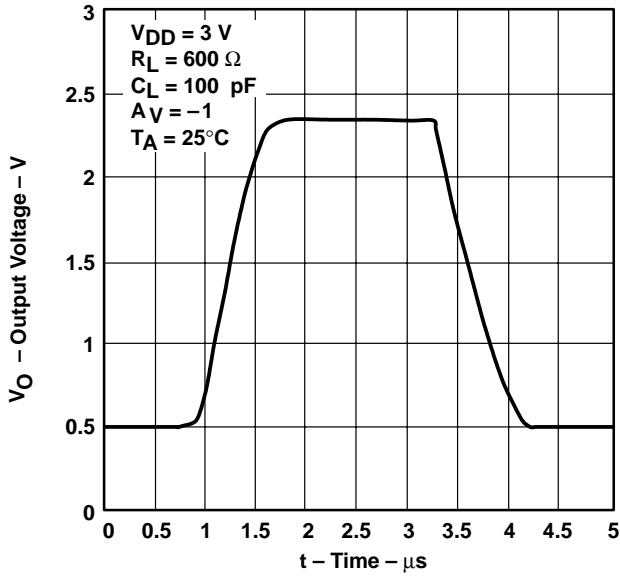

Figure 35

INVERTING LARGE-SIGNAL PULSE RESPONSE†

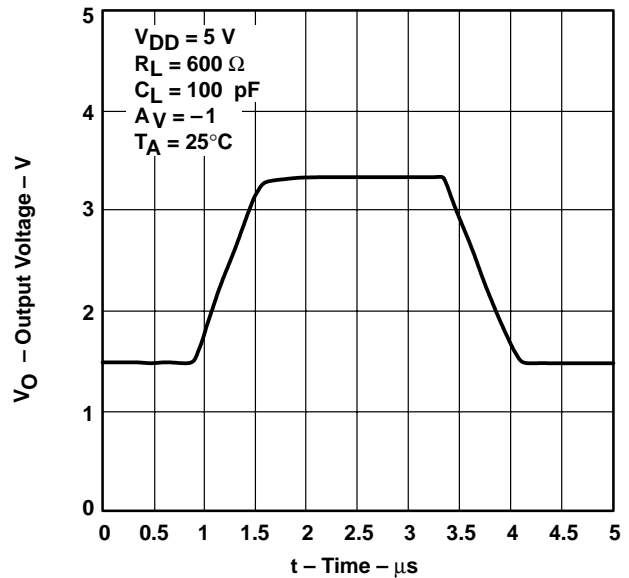

Figure 36

VOLTAGE-FOLLOWER LARGE-SIGNAL PULSE RESPONSE†

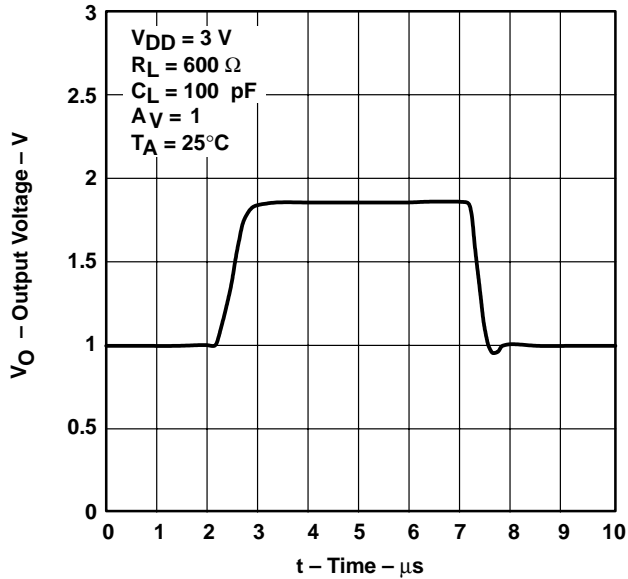

Figure 37

VOLTAGE-FOLLOWER LARGE-SIGNAL PULSE RESPONSE†

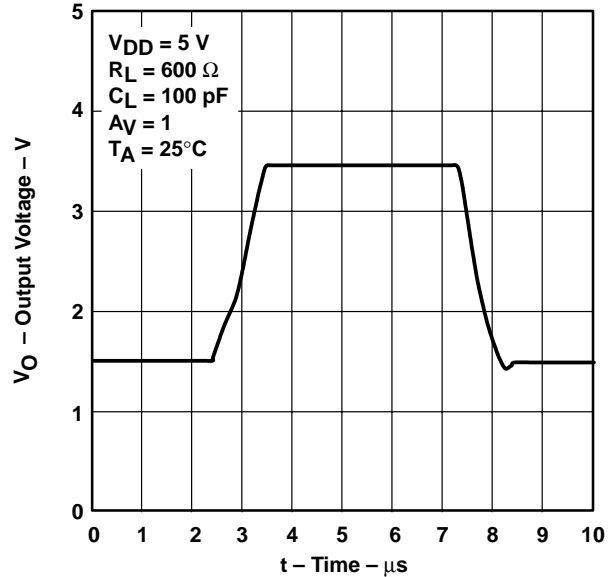
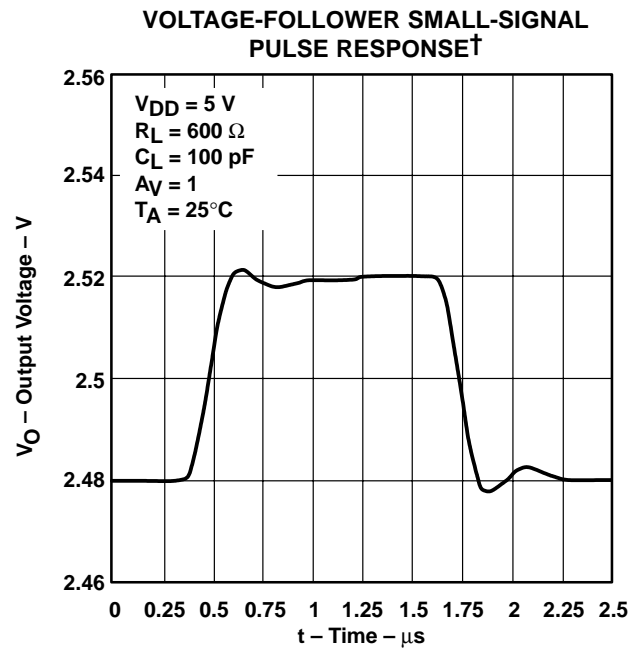
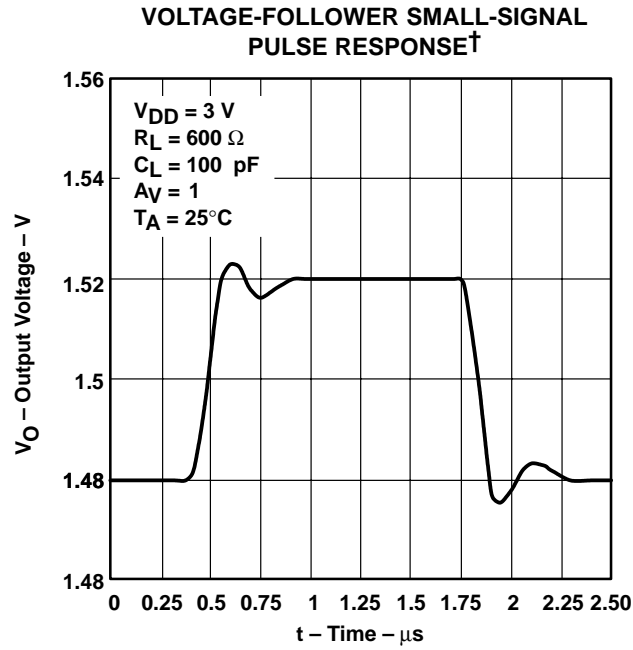
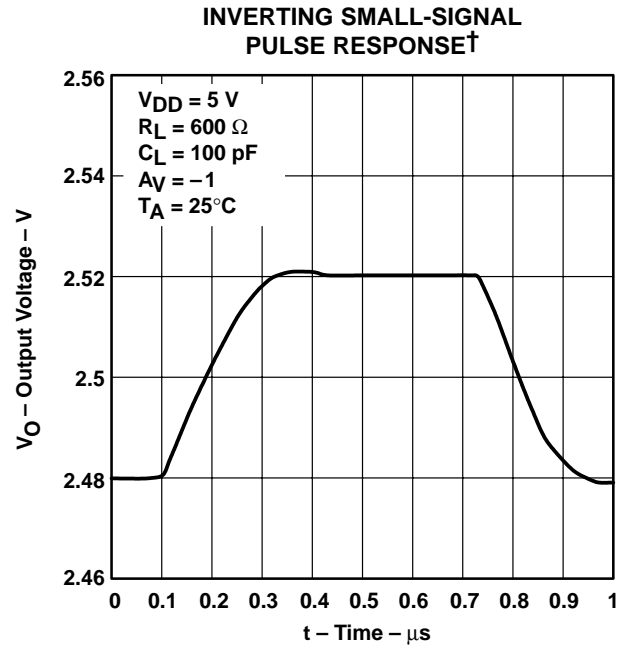
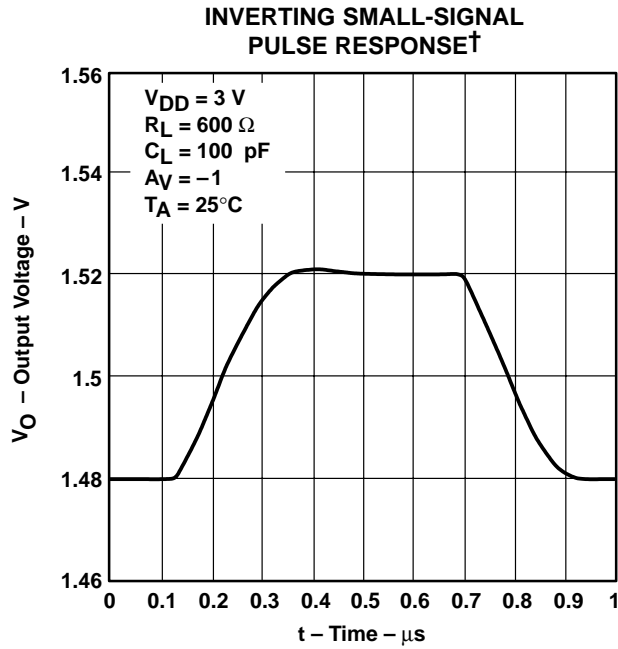

Figure 38

† For all curves where $V_{DD} = 5\text{ V}$, all loads are referenced to 2.5 V. For all curves where $V_{DD} = 3\text{ V}$, all loads are referenced to 1.5 V.

TYPICAL CHARACTERISTICS



† For all curves where $V_{DD} = 5\text{ V}$, all loads are referenced to 2.5 V. For all curves where $V_{DD} = 3\text{ V}$, all loads are referenced to 1.5 V.

TYPICAL CHARACTERISTICS

**EQUIVALENT INPUT NOISE VOLTAGE†
 VS
 FREQUENCY**

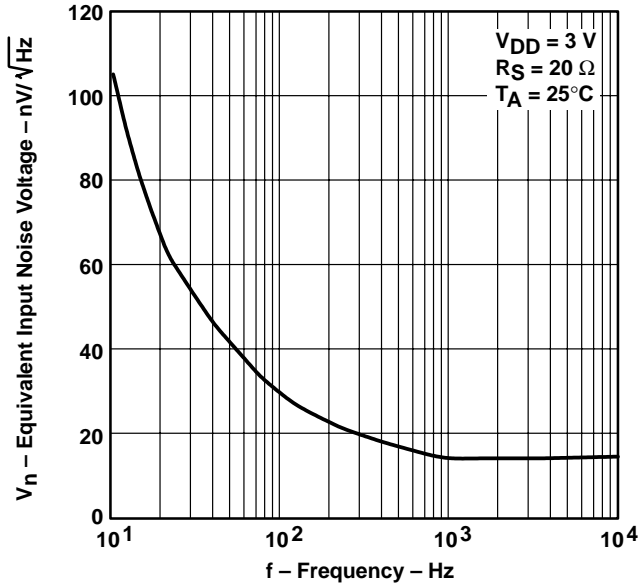

Figure 43

**EQUIVALENT INPUT NOISE VOLTAGE†
 VS
 FREQUENCY**

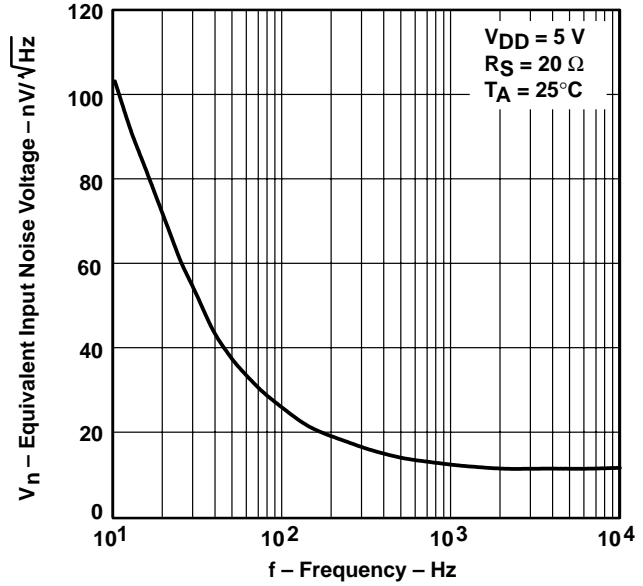

Figure 44

**INPUT NOISE VOLTAGE OVER
 A 10-SECOND PERIOD†**

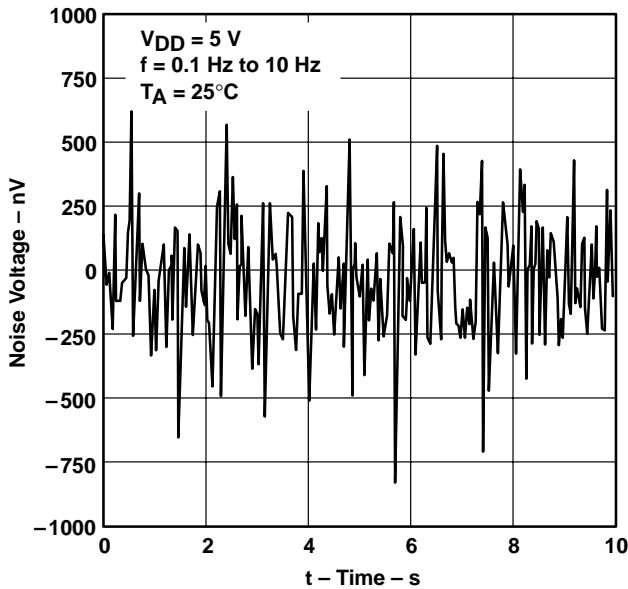

Figure 45

**TOTAL HARMONIC DISTORTION PLUS NOISE†
 VS
 FREQUENCY**

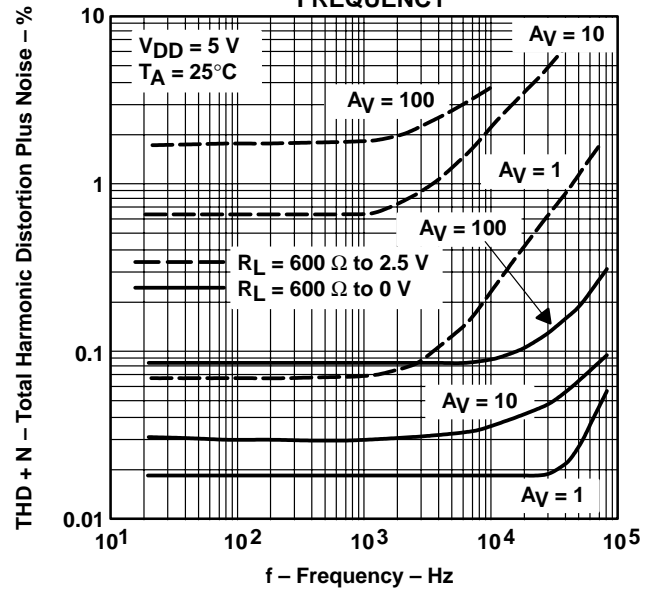
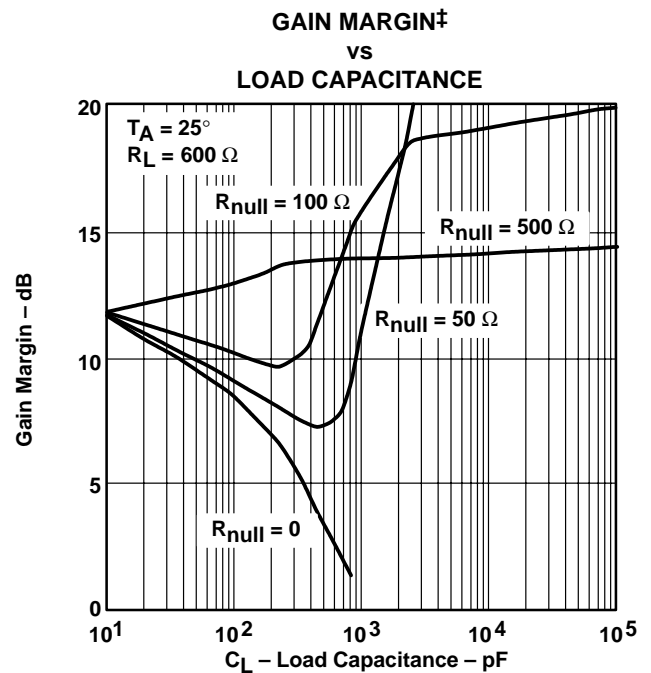
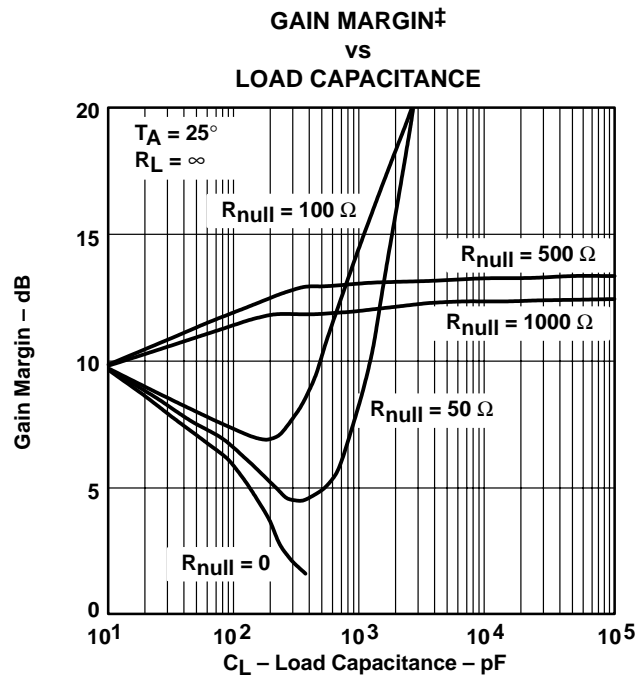
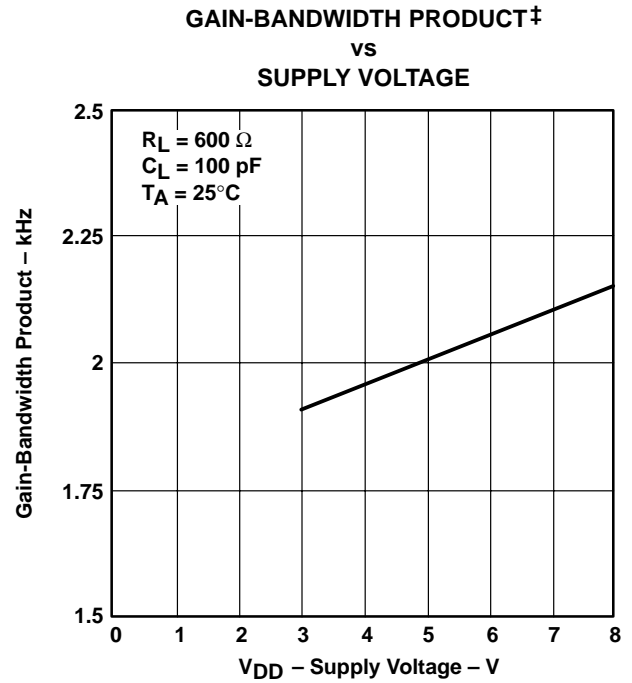
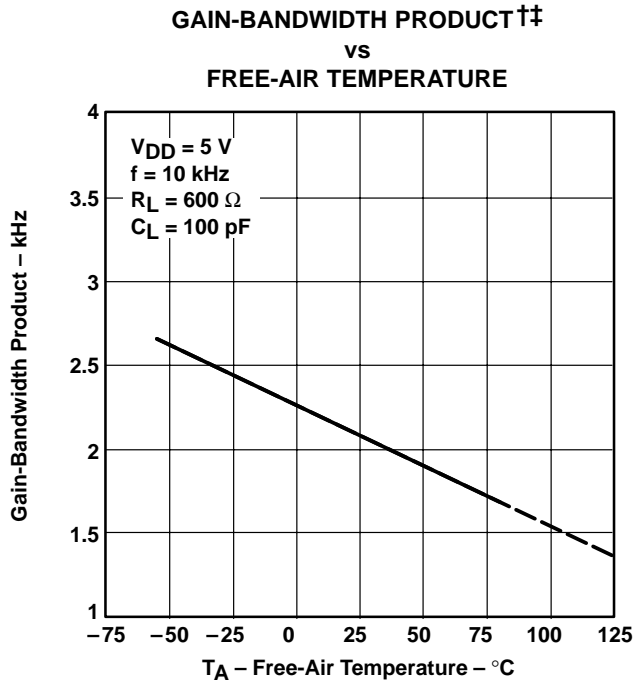

Figure 46

† For all curves where $V_{DD} = 5\text{ V}$, all loads are referenced to 2.5 V. For all curves where $V_{DD} = 3\text{ V}$, all loads are referenced to 1.5 V.

TYPICAL CHARACTERISTICS



† Data at high and low temperatures are applicable only within the rated operating free-air temperature ranges of the various devices.

‡ For all curves where $V_{DD} = 5\text{ V}$, all loads are referenced to 2.5 V. For all curves where $V_{DD} = 3\text{ V}$, all loads are referenced to 1.5 V.

TYPICAL CHARACTERISTICS

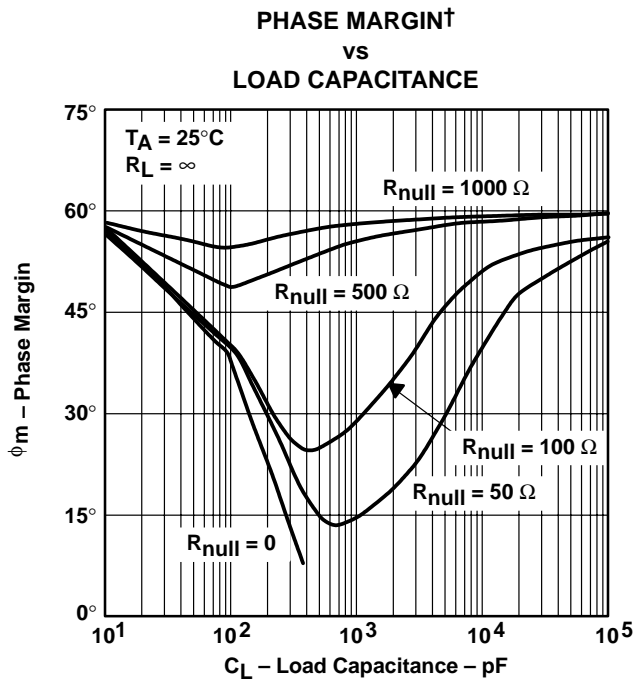

Figure 51

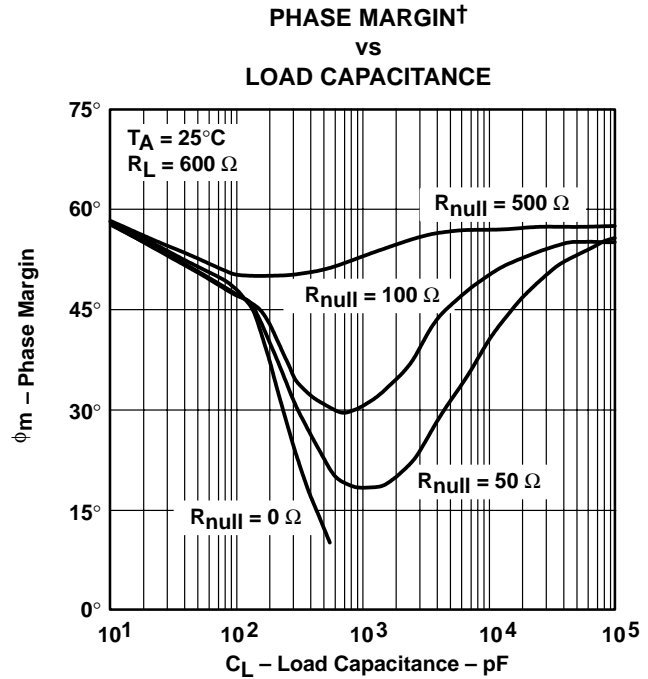

Figure 52

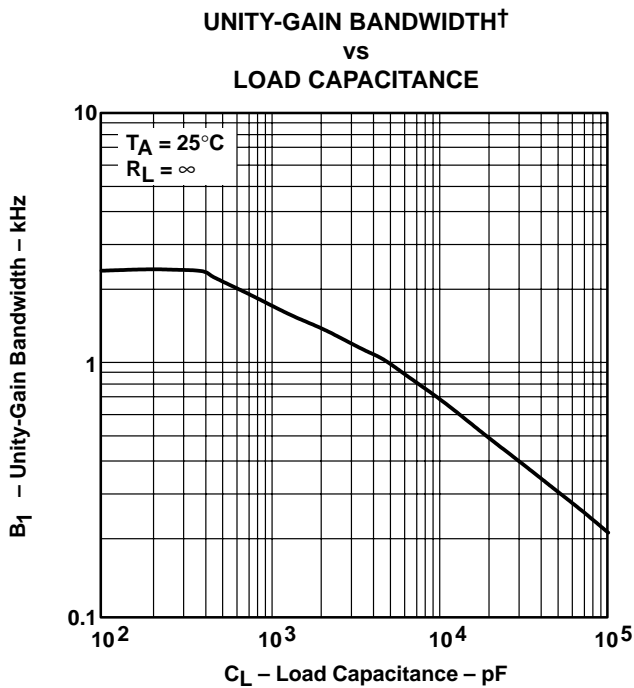

Figure 53

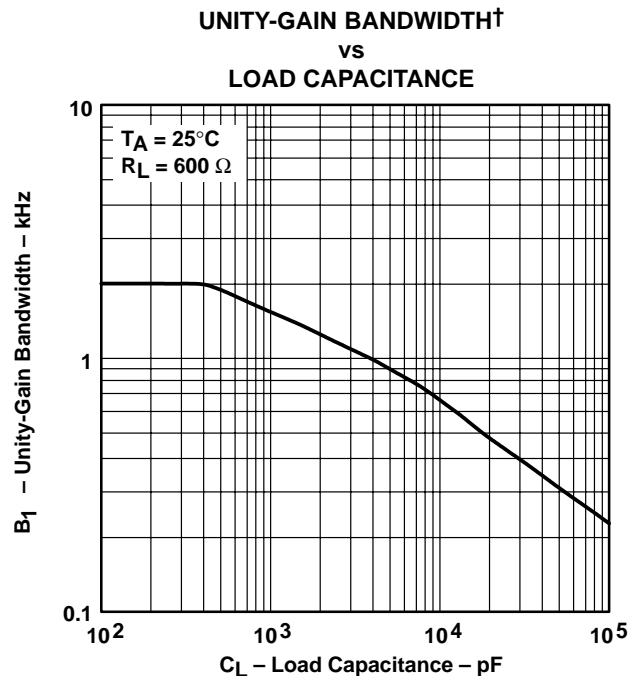

Figure 54

† For all curves where $V_{DD} = 5\text{ V}$, all loads are referenced to 2.5 V. For all curves where $V_{DD} = 3\text{ V}$, all loads are referenced to 1.5 V.

APPLICATION INFORMATION

driving large capacitive loads

The TLV2731 is designed to drive larger capacitive loads than most CMOS operational amplifiers. Figure 49 through Figure 54 illustrate its ability to drive loads greater than 100 pF while maintaining good gain and phase margins ($R_{null} = 0$).

A small series resistor (R_{null}) at the output of the device (see Figure 55) improves the gain and phase margins when driving large capacitive loads. Figure 49 through Figure 52 show the effects of adding series resistances of 50 Ω , 100 Ω , 500 Ω , and 1000 Ω . The addition of this series resistor has two effects: the first effect is that it adds a zero to the transfer function and the second effect is that it reduces the frequency of the pole associated with the output load in the transfer function.

The zero introduced to the transfer function is equal to the series resistance times the load capacitance. To calculate the approximate improvement in phase margin, equation 1 can be used.

$$\Delta\phi_{m1} = \tan^{-1} \left(2 \times \pi \times \text{UGBW} \times R_{null} \times C_L \right) \quad (1)$$

Where :

- $\Delta\phi_{m1}$ = Improvement in phase margin
- UGBW = Unity-gain bandwidth frequency
- R_{null} = Output series resistance
- C_L = Load capacitance

The unity-gain bandwidth (UGBW) frequency decreases as the capacitive load increases (see Figure 53 and Figure 54). To use equation 1, UGBW must be approximated from Figure 53 and Figure 54.

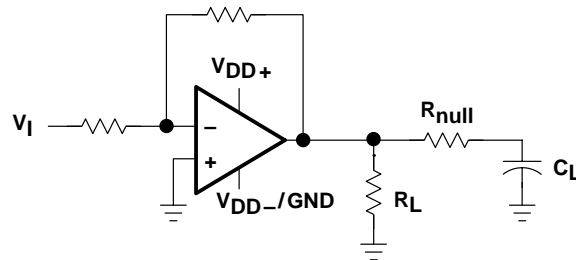
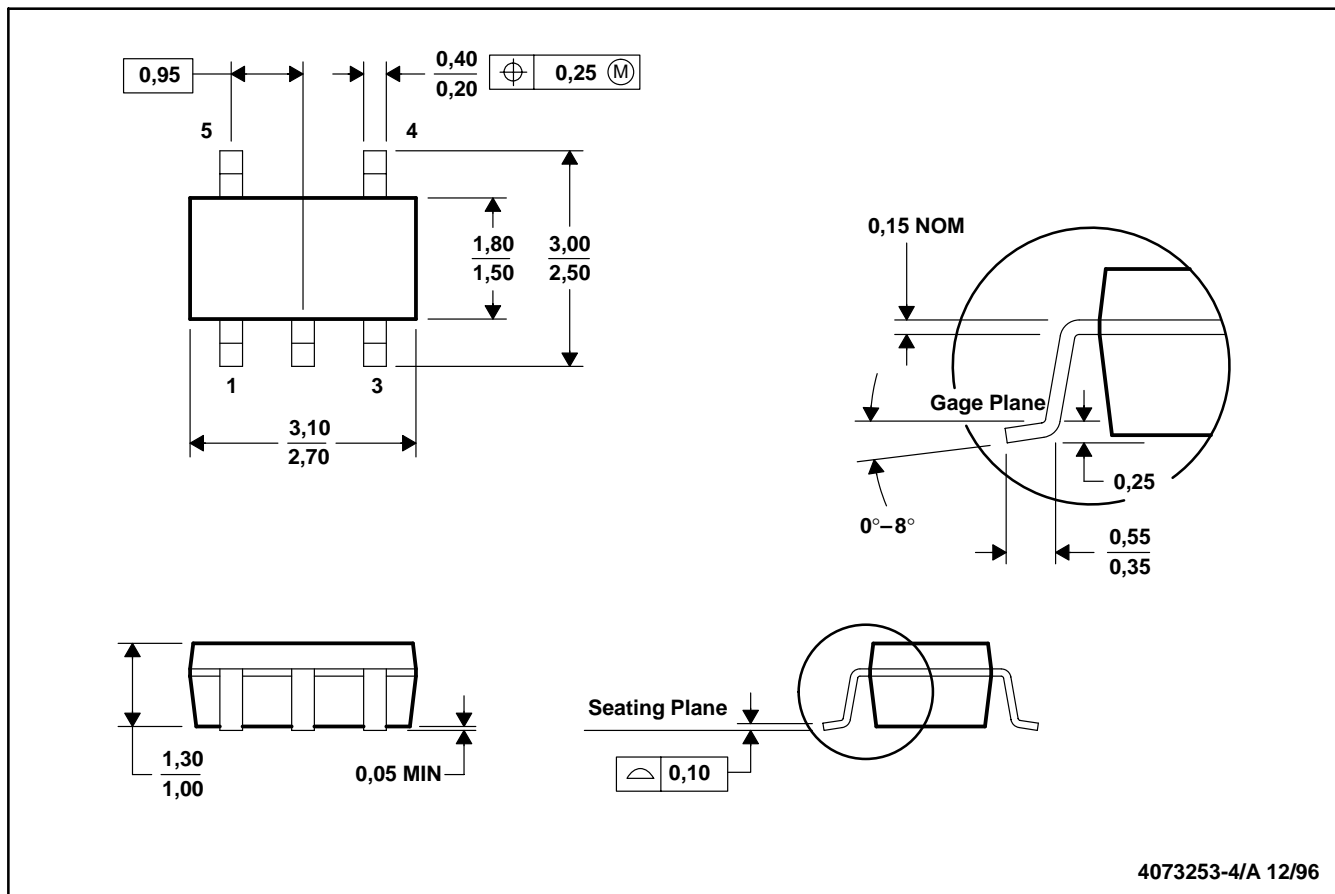

Figure 55. Series-Resistance Circuit

MECHANICAL INFORMATION

DBV (R-PDSO-G5)

PLASTIC SMALL-OUTLINE PACKAGE



- NOTES:
- A. All linear dimensions are in millimeters.
 - B. This drawing is subject to change without notice.
 - C. Body dimensions include mold flash or protrusion.

PACKAGING INFORMATION

Orderable Device	Status ⁽¹⁾	Package Type	Package Drawing	Pins	Package Qty	Eco Plan ⁽²⁾	Lead/Ball Finish	MSL Peak Temp ⁽³⁾
TLV2731CDBV	OBSOLETE	SOT-23	DBV	5		TBD	Call TI	Call TI
TLV2731CDBVR	ACTIVE	SOT-23	DBV	5	3000	Green (RoHS & no Sb/Br)	CU NIPDAU	Level-1-260C-UNLIM
TLV2731CDBVRG4	ACTIVE	SOT-23	DBV	5	3000	Green (RoHS & no Sb/Br)	CU NIPDAU	Level-1-260C-UNLIM
TLV2731CDBVT	ACTIVE	SOT-23	DBV	5	250	Green (RoHS & no Sb/Br)	CU NIPDAU	Level-1-260C-UNLIM
TLV2731CDBVTG4	ACTIVE	SOT-23	DBV	5	250	Green (RoHS & no Sb/Br)	CU NIPDAU	Level-1-260C-UNLIM
TLV2731IDBVR	ACTIVE	SOT-23	DBV	5	3000	Green (RoHS & no Sb/Br)	CU NIPDAU	Level-1-260C-UNLIM
TLV2731IDBVRG4	ACTIVE	SOT-23	DBV	5	3000	Green (RoHS & no Sb/Br)	CU NIPDAU	Level-1-260C-UNLIM
TLV2731IDBVT	ACTIVE	SOT-23	DBV	5	250	Green (RoHS & no Sb/Br)	CU NIPDAU	Level-1-260C-UNLIM
TLV2731IDBVTG4	ACTIVE	SOT-23	DBV	5	250	Green (RoHS & no Sb/Br)	CU NIPDAU	Level-1-260C-UNLIM

⁽¹⁾ The marketing status values are defined as follows:

ACTIVE: Product device recommended for new designs.

LIFEBUY: TI has announced that the device will be discontinued, and a lifetime-buy period is in effect.

NRND: Not recommended for new designs. Device is in production to support existing customers, but TI does not recommend using this part in a new design.

PREVIEW: Device has been announced but is not in production. Samples may or may not be available.

OBSOLETE: TI has discontinued the production of the device.

⁽²⁾ Eco Plan - The planned eco-friendly classification: Pb-Free (RoHS), Pb-Free (RoHS Exempt), or Green (RoHS & no Sb/Br) - please check <http://www.ti.com/productcontent> for the latest availability information and additional product content details.

TBD: The Pb-Free/Green conversion plan has not been defined.

Pb-Free (RoHS): TI's terms "Lead-Free" or "Pb-Free" mean semiconductor products that are compatible with the current RoHS requirements for all 6 substances, including the requirement that lead not exceed 0.1% by weight in homogeneous materials. Where designed to be soldered at high temperatures, TI Pb-Free products are suitable for use in specified lead-free processes.

Pb-Free (RoHS Exempt): This component has a RoHS exemption for either 1) lead-based flip-chip solder bumps used between the die and package, or 2) lead-based die adhesive used between the die and leadframe. The component is otherwise considered Pb-Free (RoHS compatible) as defined above.

Green (RoHS & no Sb/Br): TI defines "Green" to mean Pb-Free (RoHS compatible), and free of Bromine (Br) and Antimony (Sb) based flame retardants (Br or Sb do not exceed 0.1% by weight in homogeneous material)

⁽³⁾ MSL, Peak Temp. -- The Moisture Sensitivity Level rating according to the JEDEC industry standard classifications, and peak solder temperature.

Important Information and Disclaimer:The information provided on this page represents TI's knowledge and belief as of the date that it is provided. TI bases its knowledge and belief on information provided by third parties, and makes no representation or warranty as to the accuracy of such information. Efforts are underway to better integrate information from third parties. TI has taken and continues to take reasonable steps to provide representative and accurate information but may not have conducted destructive testing or chemical analysis on incoming materials and chemicals. TI and TI suppliers consider certain information to be proprietary, and thus CAS numbers and other limited information may not be available for release.

In no event shall TI's liability arising out of such information exceed the total purchase price of the TI part(s) at issue in this document sold by TI to Customer on an annual basis.

TAPE AND REEL INFORMATION

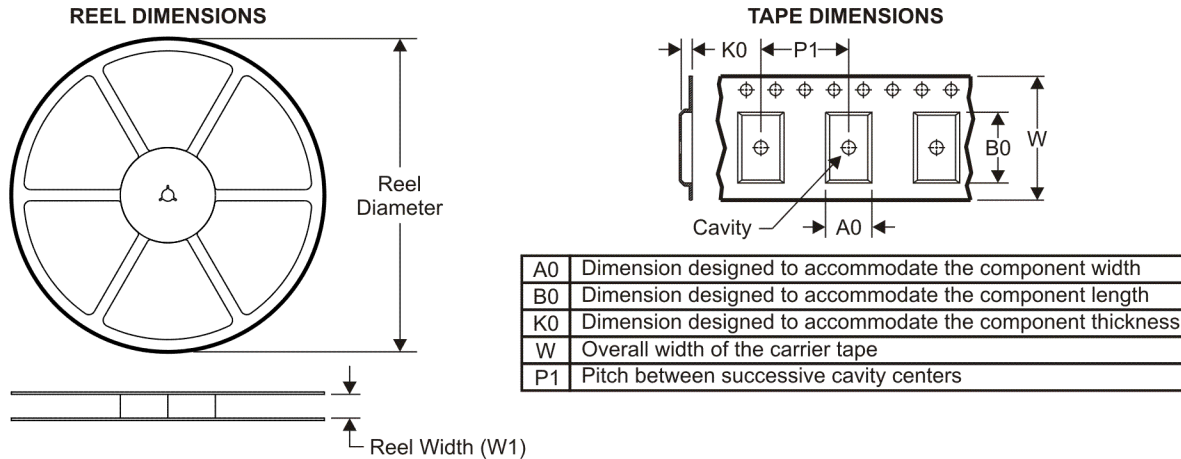

QUADRANT ASSIGNMENTS FOR PIN 1 ORIENTATION IN TAPE



*All dimensions are nominal

Device	Package Type	Package Drawing	Pins	SPQ	Reel Diameter (mm)	Reel Width W1 (mm)	A0 (mm)	B0 (mm)	K0 (mm)	P1 (mm)	W (mm)	Pin1 Quadrant
TLV2731CDBVR	SOT-23	DBV	5	3000	180.0	9.0	3.15	3.2	1.4	4.0	8.0	Q3
TLV2731CDBVT	SOT-23	DBV	5	250	180.0	9.0	3.15	3.2	1.4	4.0	8.0	Q3
TLV2731IDBVR	SOT-23	DBV	5	3000	180.0	9.0	3.15	3.2	1.4	4.0	8.0	Q3
TLV2731IDBVT	SOT-23	DBV	5	250	180.0	9.0	3.15	3.2	1.4	4.0	8.0	Q3

TAPE AND REEL BOX DIMENSIONS



*All dimensions are nominal

Device	Package Type	Package Drawing	Pins	SPQ	Length (mm)	Width (mm)	Height (mm)
TLV2731CDBVR	SOT-23	DBV	5	3000	182.0	182.0	20.0
TLV2731CDBVT	SOT-23	DBV	5	250	182.0	182.0	20.0
TLV2731IDBVR	SOT-23	DBV	5	3000	182.0	182.0	20.0
TLV2731IDBVT	SOT-23	DBV	5	250	182.0	182.0	20.0

IMPORTANT NOTICE

Texas Instruments Incorporated and its subsidiaries (TI) reserve the right to make corrections, modifications, enhancements, improvements, and other changes to its products and services at any time and to discontinue any product or service without notice. Customers should obtain the latest relevant information before placing orders and should verify that such information is current and complete. All products are sold subject to TI's terms and conditions of sale supplied at the time of order acknowledgment.

TI warrants performance of its hardware products to the specifications applicable at the time of sale in accordance with TI's standard warranty. Testing and other quality control techniques are used to the extent TI deems necessary to support this warranty. Except where mandated by government requirements, testing of all parameters of each product is not necessarily performed.

TI assumes no liability for applications assistance or customer product design. Customers are responsible for their products and applications using TI components. To minimize the risks associated with customer products and applications, customers should provide adequate design and operating safeguards.

TI does not warrant or represent that any license, either express or implied, is granted under any TI patent right, copyright, mask work right, or other TI intellectual property right relating to any combination, machine, or process in which TI products or services are used. Information published by TI regarding third-party products or services does not constitute a license from TI to use such products or services or a warranty or endorsement thereof. Use of such information may require a license from a third party under the patents or other intellectual property of the third party, or a license from TI under the patents or other intellectual property of TI.

Reproduction of TI information in TI data books or data sheets is permissible only if reproduction is without alteration and is accompanied by all associated warranties, conditions, limitations, and notices. Reproduction of this information with alteration is an unfair and deceptive business practice. TI is not responsible or liable for such altered documentation. Information of third parties may be subject to additional restrictions.

Resale of TI products or services with statements different from or beyond the parameters stated by TI for that product or service voids all express and any implied warranties for the associated TI product or service and is an unfair and deceptive business practice. TI is not responsible or liable for any such statements.

TI products are not authorized for use in safety-critical applications (such as life support) where a failure of the TI product would reasonably be expected to cause severe personal injury or death, unless officers of the parties have executed an agreement specifically governing such use. Buyers represent that they have all necessary expertise in the safety and regulatory ramifications of their applications, and acknowledge and agree that they are solely responsible for all legal, regulatory and safety-related requirements concerning their products and any use of TI products in such safety-critical applications, notwithstanding any applications-related information or support that may be provided by TI. Further, Buyers must fully indemnify TI and its representatives against any damages arising out of the use of TI products in such safety-critical applications.

TI products are neither designed nor intended for use in military/aerospace applications or environments unless the TI products are specifically designated by TI as military-grade or "enhanced plastic." Only products designated by TI as military-grade meet military specifications. Buyers acknowledge and agree that any such use of TI products which TI has not designated as military-grade is solely at the Buyer's risk, and that they are solely responsible for compliance with all legal and regulatory requirements in connection with such use.

TI products are neither designed nor intended for use in automotive applications or environments unless the specific TI products are designated by TI as compliant with ISO/TS 16949 requirements. Buyers acknowledge and agree that, if they use any non-designated products in automotive applications, TI will not be responsible for any failure to meet such requirements.

Following are URLs where you can obtain information on other Texas Instruments products and application solutions:

Products

Amplifiers	amplifier.ti.com
Data Converters	dataconverter.ti.com
DSP	dsp.ti.com
Clocks and Timers	www.ti.com/clocks
Interface	interface.ti.com
Logic	logic.ti.com
Power Mgmt	power.ti.com
Microcontrollers	microcontroller.ti.com
RFID	www.ti-rfid.com
RF/IF and ZigBee® Solutions	www.ti.com/lprf

Applications

Audio	www.ti.com/audio
Automotive	www.ti.com/automotive
Broadband	www.ti.com/broadband
Digital Control	www.ti.com/digitalcontrol
Medical	www.ti.com/medical
Military	www.ti.com/military
Optical Networking	www.ti.com/opticalnetwork
Security	www.ti.com/security
Telephony	www.ti.com/telephony
Video & Imaging	www.ti.com/video
Wireless	www.ti.com/wireless

Mailing Address: Texas Instruments, Post Office Box 655303, Dallas, Texas 75265
Copyright © 2008, Texas Instruments Incorporated