

**NEW**



Automotive High-speed Differential Transmission  
Compatible Connector

CONNECTOR

MB-0304-1

October 2015

# MX38 Series

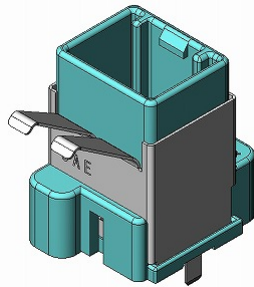

Straight Pin Connector

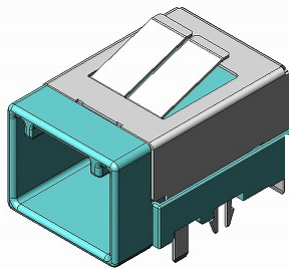

Angle Pin Connector

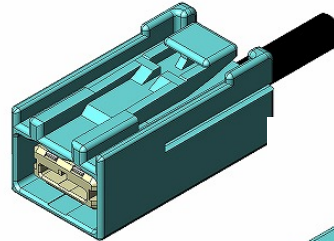

Socket Connector

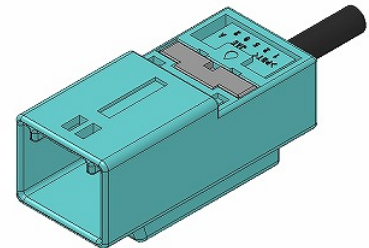

In-line Connector

Along with the advancement of electronics in the automotive field, the use of displays is rapidly growing to support safety features using surround view systems and LCD instrument panels, and rear seat entertainment.

As the display size and resolution are increasing, the transmission signals have shifted from analog to digital high-speed differential pairs, which can send large amounts of data more efficiently.

To meet these demands, the MX38 Series high-speed differential transmission compatible connector has been developed.

The MX38 Series is compatible with GVIF and LVDS transmission which is ideal for in-car video signal transmission.

GVIF is a trademark of Sony Corporation.

## Features

- 2.2mm pitch, 2 signal lines.
- Compatible with GVIF and LVDS transmission.
- Impedance-matching design for high-speed transmission.
- Available in different keying to prevent mis-mating. (4 types available)
- Mechanical lock and twist-resistant structure.
- Dual-shield structure with ground terminals for EMI control.
- Available as a complete harness to ensure transmission performance reliability.

## General Specifications

- No. of Contacts: 2-position
- Dielectric Withstanding Voltage: AC1000V applied for 1 minute (when mated)
- Operating Temperature: -40 Deg. C to +85 Deg. C
- Insulation Resistance: 100M  $\Omega$  min. (when mated)
- Applicable Board Thickness: t1.6mm
- Applicable Cable: Shielded twisted-pair cable. (sold as harness product)
- Connector Insertion Force: 70N max.

Materials and Finishes
------------------------

### ■ Pin Connector

Component	Material / Finish
Signal Terminal	Brass / Contact area: Au plating over Ni Board connection area: Sn plating
Outer Housing Inner Housing	SPS-GF30
GND Terminal, Shield Shell	Copper alloy / Sn plating

### ■ Socket Connector

Component	Material / Finish
Signal Terminal	Copper alloy / Contact area: Au plating over Ni Cable connection area: Sn plating
Outer Housing Retainer	PBT
Inner Housing Holder	LCP-GF35
GND Terminal	Copper alloy / Sn plating
Cover Shell, Sleeve	Brass / Sn plating

### ■ In-line Connector

Component	Material / Finish
Signal Terminal	Brass / Contact area: Au plating over Ni Cable connection area: Sn plating
Outer Housing Retainer	PBT
Inner Housing Holder	LCP-GF35
GND Terminal	Copper alloy / Sn plating
GND Plate Cover Shell, Sleeve	Brass / Sn plating

Outer Dimensions

■ Angle Pin Connector (MX38002NQ4) Drawing: SJ102056

Unit: mm

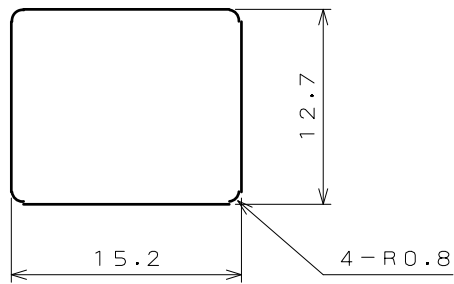
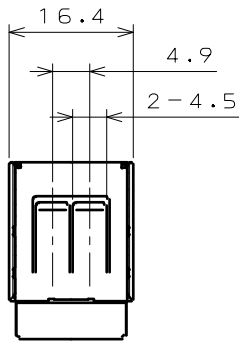

PANEL CUT OUT DIMENSION(REF.)

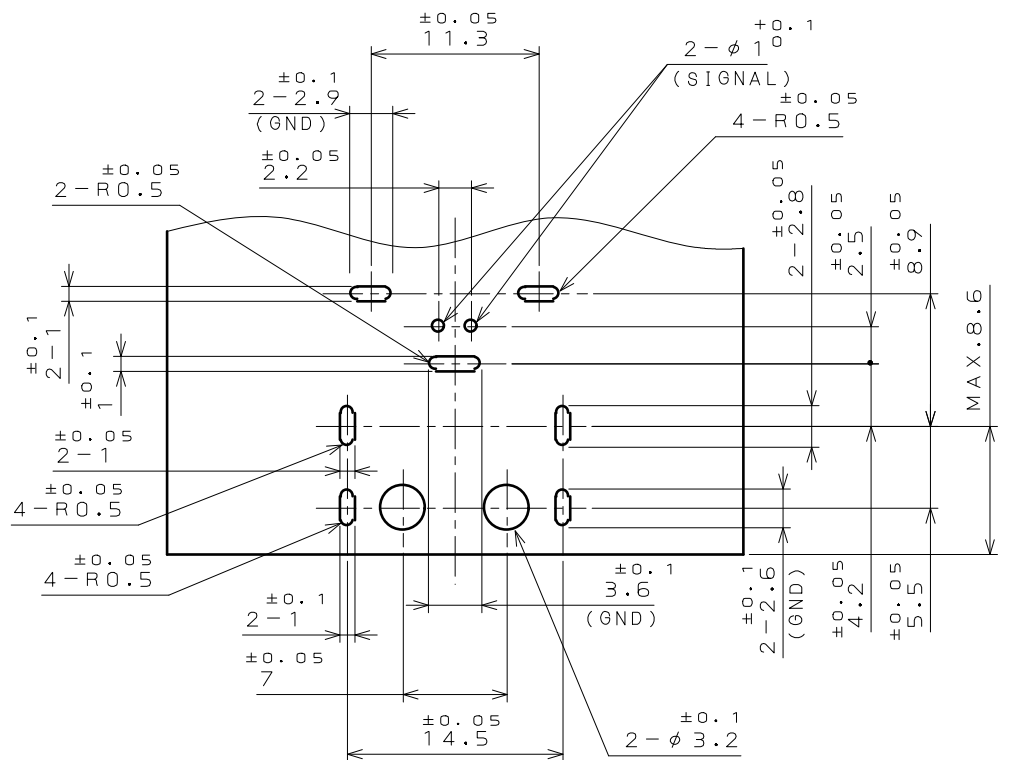
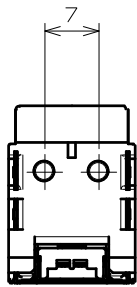
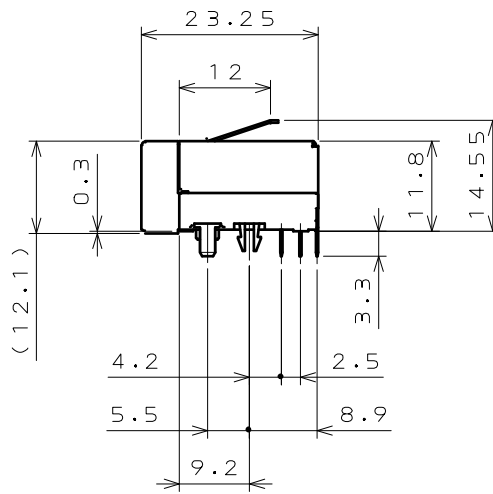
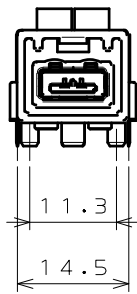

APPLICABLE P.C.B DIMENSION(REF.)

Outer Dimensions

■ Straight Pin Connector (MX38002UQ1) Drawing: SJ101167

Unit: mm

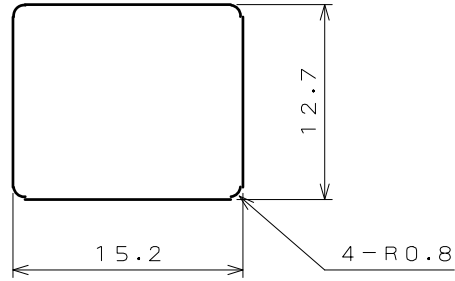
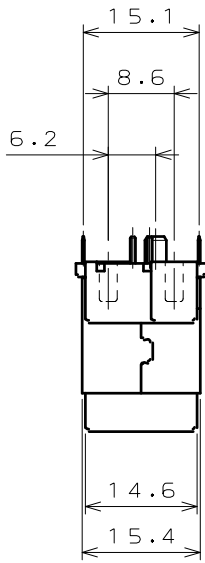

PANEL CUT OUT DIMENSION(REF.)

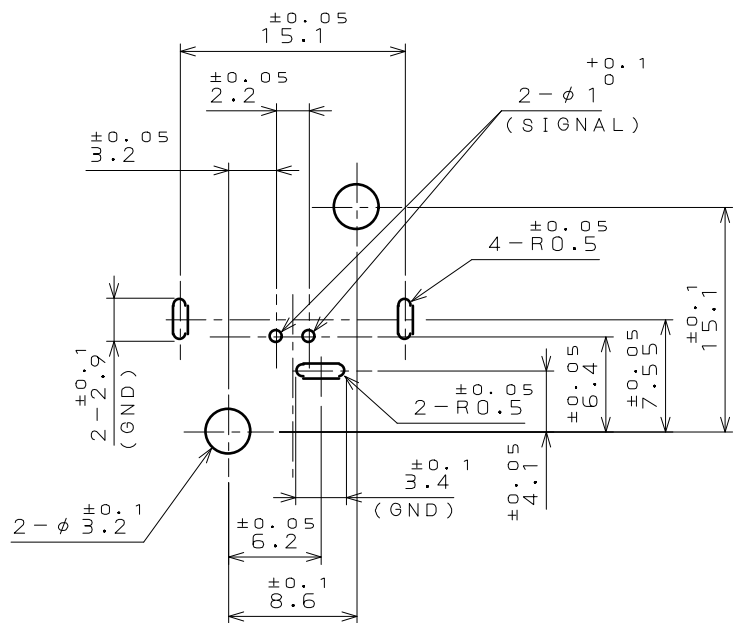
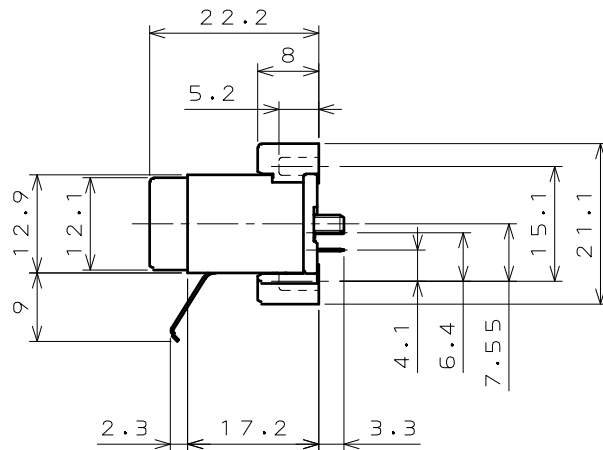
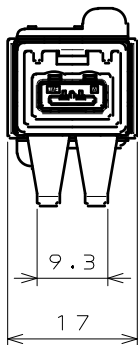

APPLICABLE P.C.B DIMENSION(REF.)

■ Socket Connector (for reference)

Unit: mm

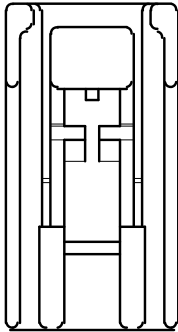

Note) Socket connector is sold as a harnessed product and is not sold as an individual product.

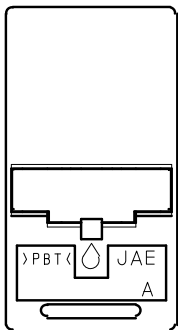
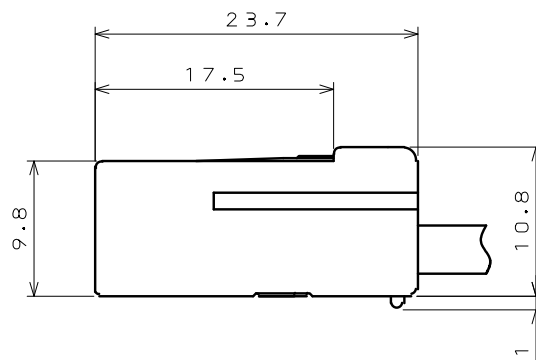
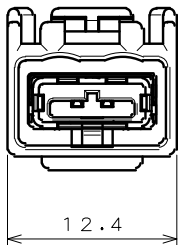

■ In-line Connector ( for reference)





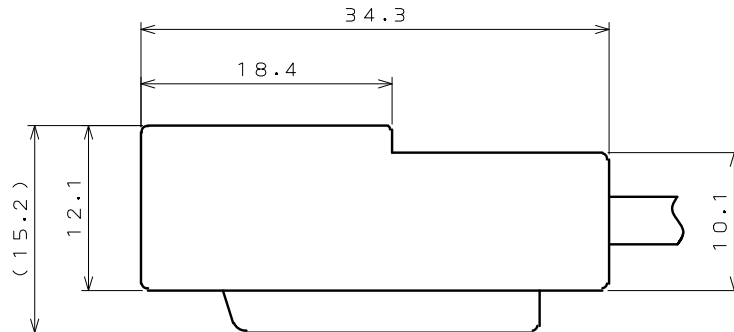
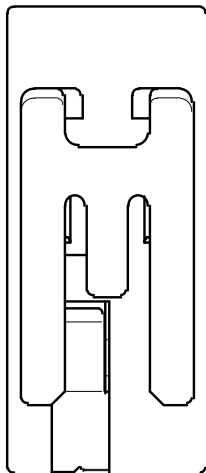
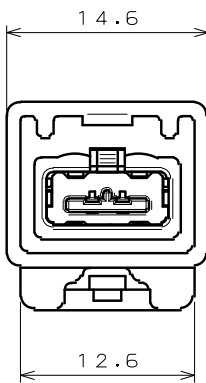
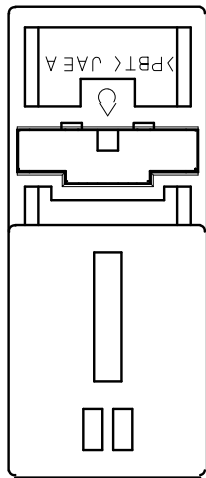

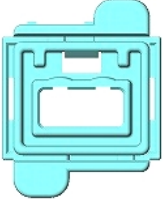

Unit: mm

Note) Socket connector is sold as a harnessed product and is not sold as an individual product.

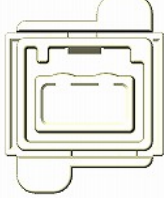
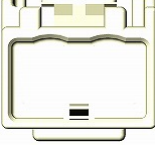
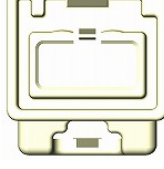

Key Shape

■ Key Type (Shape) / Insulator Color

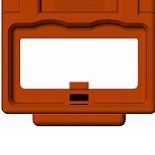
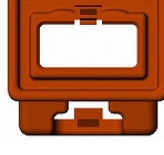
Key Type	Pin Connector		Socket Connector	In-line Connector	Outer Insulator Color
	Angle	Straight			
A					Light Blue
B					White
C		/			Green
D					Brown

Others

Specification

JACS-10211

**Notice:**

1. The values specified in this brochure are only for reference. The products and their specifications are subject to change without notice. Contact our sales staff for further information before considering or ordering any of our products. For purchase, a product specification must be agreed upon.

2. Users are requested to provide protection circuits and redundancy circuits to ensure safety of the equipment, and sufficiently review the suitability of JAE's products to the equipment.

3. The products presented in this brochure are designed for the uses recommended below. We strongly suggest you contact our sales staff when considering use of any of the products in any other way than the recommended applications or for a specific use that requires an extremely high reliability.

(1) Applications that require consultation:

(i) Please contact us if you are considering use involving a quality assurance program that you specify or that is peculiar to the industry, such as:

Automotive electrical components, train control, telecommunications devices (mainline), traffic light control, electric power, combustion control, fire prevention or security systems, disaster prevention equipment, etc.

(ii) We may separately give you our support with a quality assurance program that you specify, when you think of a use such as :

Aviation or space equipment, submarine repeaters, nuclear power control systems, medical equipment for life support, etc.

(2) Recommended applications include:

Computers, office appliances, telecommunications devices (terminals, mobile units), measuring equipment, audiovisual equipment, home electric appliances, factory automation equipment, etc

**Japan Aviation Electronics Industry, Limited**

Product Marketing Division

Aobadai Building, 3-1-19, Aobadai, Meguro-ku, Tokyo 153-8539

Phone: +81-3-3780-2882 FAX: +81-3-3780-2946

\* The specifications in this brochure are subject to change without notice. Please contact JAE for information.



# Mouser Electronics

Authorized Distributor

Click to View Pricing, Inventory, Delivery & Lifecycle Information:

[JAE Electronics:](#)

[MX38002UQ1](#)