

LOC	DIST	REVISIONS			
P	LTR	DESCRIPTION	DATE	DWN	APVD
E	B	BA1	REVISED PER ECO-11-005150	29MAR2011	RK HMR

FOR FURTHER INFORMATION SEE DATA SHEET FOR
CPF SERIES-THIN FILM PRECISION CHIP RESISTORS

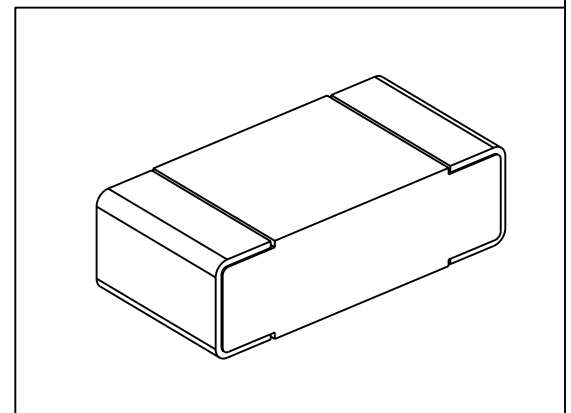
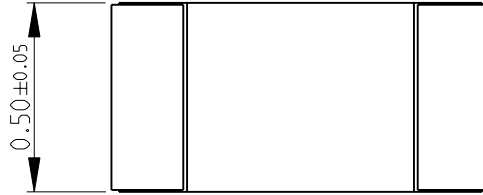

RoHS Compliant

2008

RELEASED FOR PUBLICATION

ALL RIGHTS RESERVED.

BY -

2008



THIS DRAWING IS UNPUBLISHED.

DIMENSIONS: mm	DWN	27-Sep-08	MATERIAL	-	FINISH	-
	CHK	27-Sep-08	TE Connectivity			
TOLERANCES UNLESS OTHERWISE SPECIFIED:	APVD	27-Sep-08				
	0 PLC ± 0.2	PRODUCT SPEC	SIZE	CAGE CODE	DRAWING NO	RESTRICTED TO
1 PLC ± 0.1	-	APPLICATION SPEC	A 4	00779	© = 1879208	-
2 PLC ± -	WEIGHT	-	CUSTOMER DRAWING			SCALE
3 PLC ± -	-	-	SCALE 50:1			SHEET 1 OF 1
4 PLC ± -	-	-	REV BA1			
ANGLES ± 5°						

Mouser Electronics

Authorized Distributor

Click to View Pricing, Inventory, Delivery & Lifecycle Information:

[TE Connectivity:](#)

[CPF0402B33RE1](#)