

CDBB240-HF Thru. CDBB2100-HF

Reverse Voltage: 40 to 100 Volts

Forward Current: 2.0 Amp

RoHS Device

Halogen Free

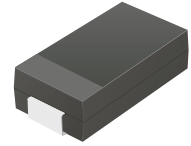

Features

- Low Profile surface mount applications in order to optimize board space.
- Low power loss, high efficiency.
- High current capability, low forward voltage drop.
- High surge capability.
- Guard ring for overvoltage protection.
- Ultra high-speed switching.
- Silicon epitaxial planar chip, metal silicon junction.

Mechanical data

- Epoxy: UL94-V0 rate flame retardant.
- Case: Molded plastic, DO-214AA / SMB
- Terminals: solderable per MIL-STD-750, method 2026.
- Polarity: Indicated by cathode band.
- weight: 0.091 grams

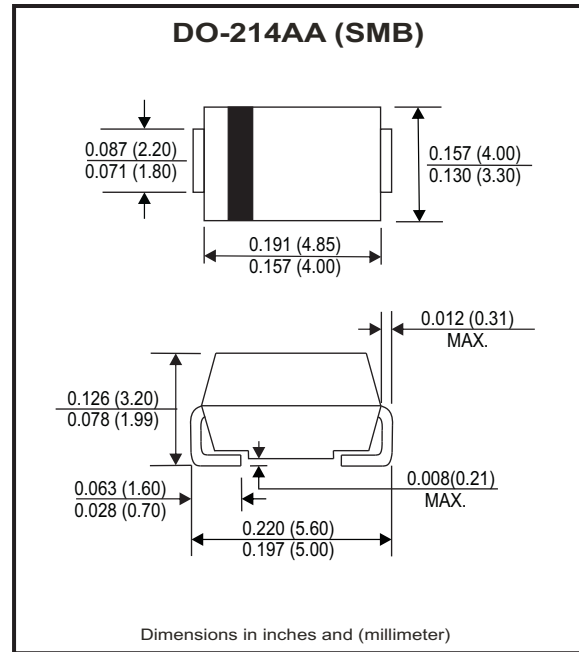

Maximum Ratings and Electrical Characteristics

Ratings at Ta=25°C unless otherwise noted.
Single phase, half wave, 60Hz, resistive or inductive loaded.
For capacitive load, derate current by 20% .

Parameter	Symbol	CDBB 240-HF	CDBB 260-HF	CDBB 2100-HF	Units
Max. Repetitive peak reverse voltage	V _{RRM}	40	60	100	V
Max. DC blocking voltage	V _{DC}	40	60	100	V
Max. RMS voltage	V _{RMS}	28	42	70	V
Max. instantaneous forward voltage @2.0A, T _A =25°C	V _F	0.50	0.70	0.81	V
Operating Temperature	T _J	-50 to +150			°C

Parameter	Conditions	Symbol	MIN.	TYP.	MAX.	Units
Forward rectified current	see Fig.1	I _o			2.0	A
Forward surge current	8.3ms single half sine-wave superimposed on rate load (JEDEC method)	I _{FSM}			50	A
Reverse Current	V _R =V _{RRM} T _A =25°C	I _R			0.5	mA
	V _R =V _{RRM} T _A =100°C	I _R			20	mA
Thermal Resistance	Junction to ambient	R _{θJA}		50		°C/W
Diode Junction capacitance	f=1MHz and applied 4V DC reverse Voltage	C _J		30		pF
Storage temperature		T _{STG}	-50		+175	°C

Company reserves the right to improve product design , functions and reliability without notice.

REV: D

RATING AND CHARACTERISTIC CURVES (CDBB240-HF Thru. CDBB2100-HF)

Fig.1 - Typical Forward Current Derating Curve

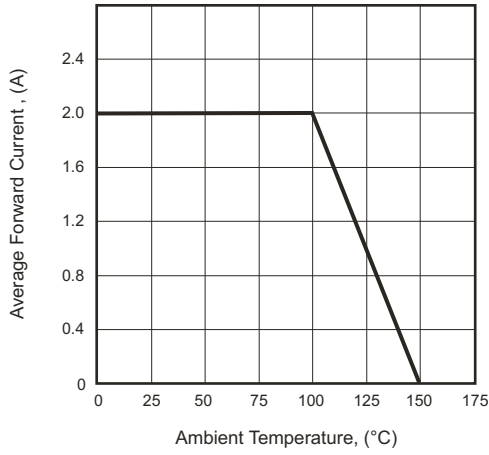

Fig.2 - Typical Forward Characteristics

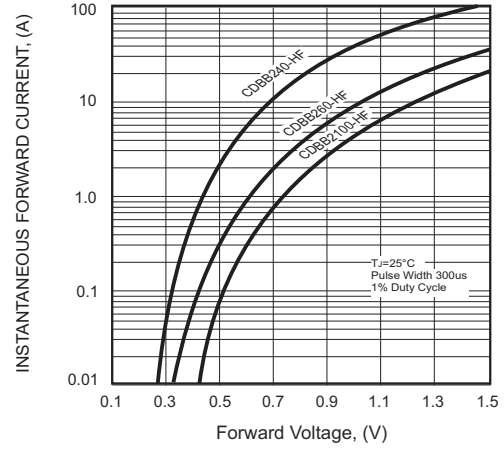

Fig.3 - Maximum Non-repetitive Forward Surge Current

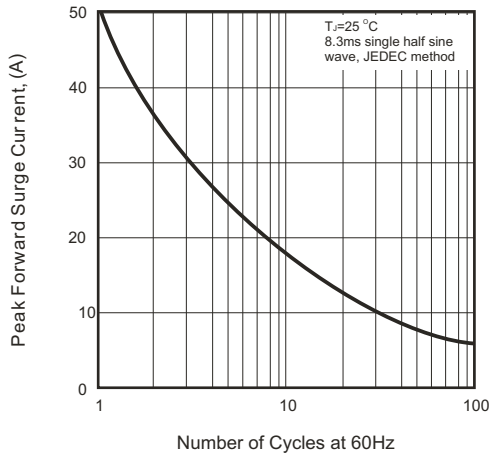

Fig.4 - Typical Junction Capacitance

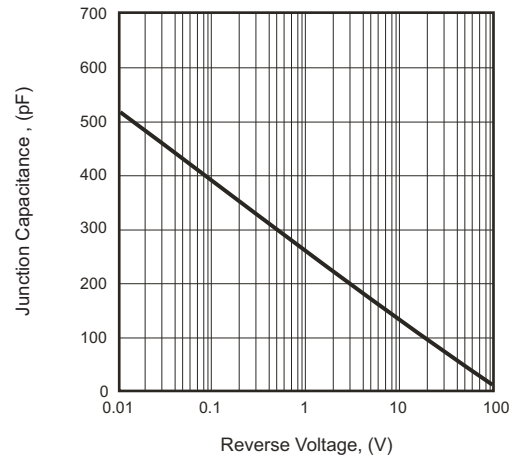
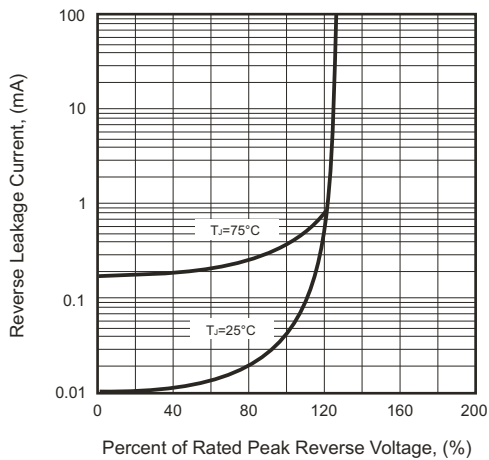
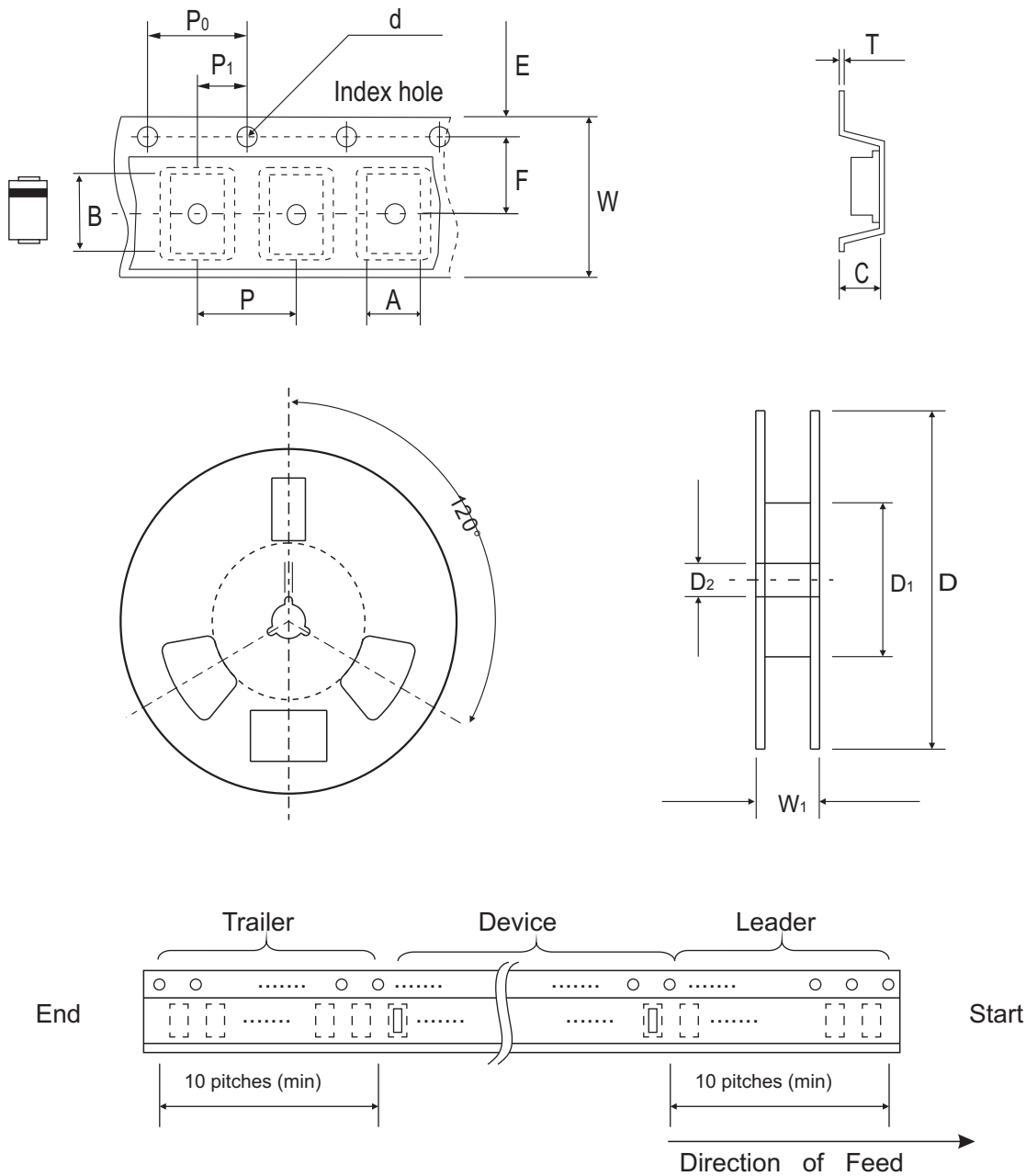

Fig.5 - Typical Reverse Characteristics



Company reserves the right to improve product design, functions and reliability without notice.

Reel Taping Specification



DO-214AA (SMB)	SYMBOL	A	B	C	d	D	D1	D2
	(mm)	4.00 ± 0.10	5.90 ± 0.10	3.00 ± 0.10	1.50 ± 0.10	330 ± 2.00	50.0 MIN.	13.50 ± 0.50
	(inch)	0.157 ± 0.004	0.232 ± 0.004	0.118 ± 0.004	0.059 ± 0.004	12.99 ± 0.079	1.969 MIN.	0.531 ± 0.020

DO-214AA (SMB)	SYMBOL	E	F	P	P0	P1	T	W	W1
	(mm)	1.75 ± 0.10	5.50 ± 0.10	8.00 ± 0.10	4.00 ± 0.10	2.00 ± 0.10	0.60 ± 0.10	12.0 ± 0.30	18.4 ± 1.00
	(inch)	0.069 ± 0.004	0.217 ± 0.004	0.315 ± 0.004	0.157 ± 0.004	0.079 ± 0.004	0.236 ± 0.004	0.472 ± 0.012	0.724 ± 0.040

Company reserves the right to improve product design , functions and reliability without notice.

REV: D

Marking Code

Part Number	Marking Code
CDBB240-HF	240
CDBB260-HF	260
CDBB2100-HF	2100

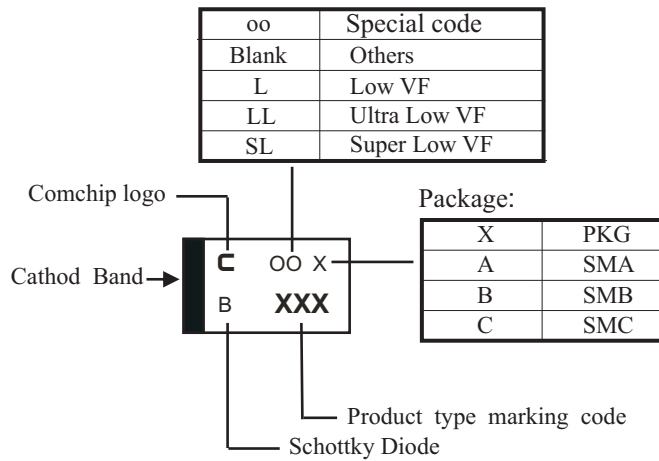

xxx/xxxx = Product type marking code

Suggested PAD Layout

SIZE	DO-214AA(SMB)	
	(mm)	(inch)
A	4.30	0.169
B	2.50	0.098
C	2.30	0.091
D	6.80	0.268
E	1.80	0.071

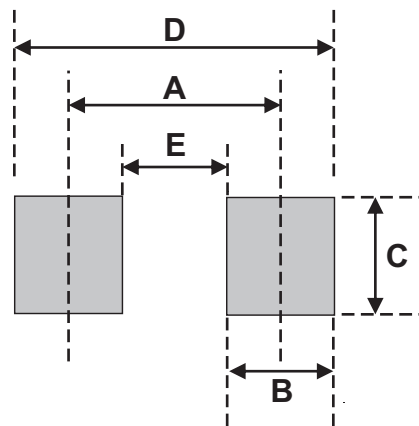

Standard Packaging

Case Type	REEL PACK	
	REEL (pcs)	Reel Size (inch)
DO-214AA (SMB)	3,000	13

Mouser Electronics

Authorized Distributor

Click to View Pricing, Inventory, Delivery & Lifecycle Information:

[Comchip Technology:](#)

[CDBB2100-HF](#) [CDBB2100-G](#)