



Is Now Part of



**ON Semiconductor®**

To learn more about ON Semiconductor, please visit our website at  
[www.onsemi.com](http://www.onsemi.com)

Please note: As part of the Fairchild Semiconductor integration, some of the Fairchild orderable part numbers will need to change in order to meet ON Semiconductor's system requirements. Since the ON Semiconductor product management systems do not have the ability to manage part nomenclature that utilizes an underscore (\_), the underscore (\_) in the Fairchild part numbers will be changed to a dash (-). This document may contain device numbers with an underscore (\_). Please check the ON Semiconductor website to verify the updated device numbers. The most current and up-to-date ordering information can be found at [www.onsemi.com](http://www.onsemi.com). Please email any questions regarding the system integration to [Fairchild\\_questions@onsemi.com](mailto:Fairchild_questions@onsemi.com).

ON Semiconductor and the ON Semiconductor logo are trademarks of Semiconductor Components Industries, LLC dba ON Semiconductor or its subsidiaries in the United States and/or other countries. ON Semiconductor owns the rights to a number of patents, trademarks, copyrights, trade secrets, and other intellectual property. A listing of ON Semiconductor's product/patent coverage may be accessed at [www.onsemi.com/site/pdf/Patent-Marking.pdf](http://www.onsemi.com/site/pdf/Patent-Marking.pdf). ON Semiconductor reserves the right to make changes without further notice to any products herein. ON Semiconductor makes no warranty, representation or guarantee regarding the suitability of its products for any particular purpose, nor does ON Semiconductor assume any liability arising out of the application or use of any product or circuit, and specifically disclaims any and all liability, including without limitation special, consequential or incidental damages. Buyer is responsible for its products and applications using ON Semiconductor products, including compliance with all laws, regulations and safety requirements or standards, regardless of any support or applications information provided by ON Semiconductor. "Typical" parameters which may be provided in ON Semiconductor data sheets and/or specifications can and do vary in different applications and actual performance may vary over time. All operating parameters, including "Typicals" must be validated for each customer application by customer's technical experts. ON Semiconductor does not convey any license under its patent rights nor the rights of others. ON Semiconductor products are not designed, intended, or authorized for use as a critical component in life support systems or any FDA Class 3 medical devices or medical devices with a same or similar classification in a foreign jurisdiction or any devices intended for implantation in the human body. Should Buyer purchase or use ON Semiconductor products for any such unintended or unauthorized application, Buyer shall indemnify and hold ON Semiconductor and its officers, employees, subsidiaries, affiliates, and distributors harmless against all claims, costs, damages, and expenses, and reasonable attorney fees arising out of, directly or indirectly, any claim of personal injury or death associated with such unintended or unauthorized use, even if such claim alleges that ON Semiconductor was negligent regarding the design or manufacture of the part. ON Semiconductor is an Equal Opportunity/Affirmative Action Employer. This literature is subject to all applicable copyright laws and is not for resale in any manner.



November 2014

# MMBD4148 / MMBD4148SE / MMBD4148CC / MMBD4148CA Small Signal Diode

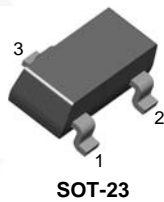

Connection Diagram

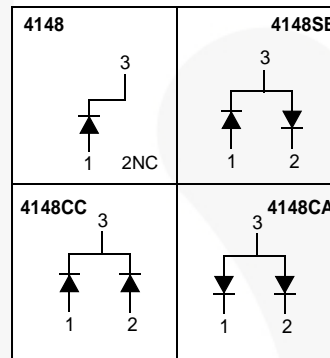

## Ordering Information

| Part Number   | Top Mark | Package   | Packing Method |
|---------------|----------|-----------|----------------|
| MMBD4148      | 5H       | SOT-23 3L | Tape and Reel  |
| MMBD4148_D87Z | 5H       | SOT-23 3L | Tape and Reel  |
| MMBD4148SE    | D4       | SOT-23 3L | Tape and Reel  |
| MMBD4148CC    | D5       | SOT-23 3L | Tape and Reel  |
| MMBD4148CA    | D6       | SOT-23 3L | Tape and Reel  |

## Absolute Maximum Ratings

Stresses exceeding the absolute maximum ratings may damage the device. The device may not function or be operable above the recommended operating conditions and stressing the parts to these levels is not recommended. In addition, extended exposure to stresses above the recommended operating conditions may affect device reliability. The absolute maximum ratings are stress ratings only. Values are at  $T_A = 25^\circ\text{C}$  unless otherwise noted.

| Symbol      | Parameter                                 |                               | Value       | Unit             |
|-------------|---|-------------------------------|-------------|------------------|
| $V_{RRM}$   | Maximum Repetitive Reverse Voltage        |                               | 100         | V                |
| $I_{F(AV)}$ | Average Rectified Forward Current         |                               | 200         | mA               |
| $I_{FSM}$   | Non-Repetitive Peak Forward Surge Current | Pulse Width = 1.0 second      | 1.0         | A                |
|             |   | Pulse Width = 1.0 microsecond | 2.0         |                  |
| $T_{STG}$   | Storage Temperature Range                 |                               | -55 to +150 | $^\circ\text{C}$ |
| $T_J$       | Operating Junction Temperature            |                               | 150         | $^\circ\text{C}$ |

MMBD4148 / MMBD4148SE / MMBD4148CC / MMBD4148CA — Small Signal Diode

## Thermal Characteristics

Values are at  $T_A = 25^\circ\text{C}$  unless otherwise noted.

| Symbol          | Parameter                               | Value | Unit                      |
|-----------------|---|-------|---------------------------|
| $P_D$           | Power Dissipation                       | 350   | mW                        |
| $R_{\theta JA}$ | Thermal Resistance, Junction-to-Ambient | 357   | $^\circ\text{C}/\text{W}$ |

## Electrical Characteristics

Values are at  $T_A = 25^\circ\text{C}$  unless otherwise noted.

| Symbol   | Parameter               | Conditions  | Min. | Max. | Unit          |
|----------|-------------------------|---|------|------|---------------|
| $V_R$    | Breakdown Voltage       | $I_R = 5.0 \mu\text{A}$   | 75   |      | V             |
|          |                         | $I_R = 100 \mu\text{A}$   | 100  |      |               |
| $V_F$    | Forward Voltage         | $I_F = 10 \text{ mA}$   |      | 1.0  | V             |
| $I_R$    | Reverse Leakage Current | $V_R = 20 \text{ V}$  |      | 25   | nA            |
|          |                         | $V_R = 20 \text{ V}, T_A = 150^\circ\text{C}$   |      | 50   | $\mu\text{A}$ |
|          |                         | $V_R = 75 \text{ V}$  |      | 5.0  | $\mu\text{A}$ |
| $C_T$    | Total Capacitance       | $V_R = 0 \text{ V}, f = 1.0 \text{ MHz}$  |      | 4.0  | pF            |
| $t_{rr}$ | Reverse Recovery Time   | $I_F = 10 \text{ mA}, V_R = 6.0 \text{ V}, I_{RR} = 1.0 \text{ mA}, R_L = 100 \Omega$ |      | 4.0  | ns            |

## Typical Performance Characteristics

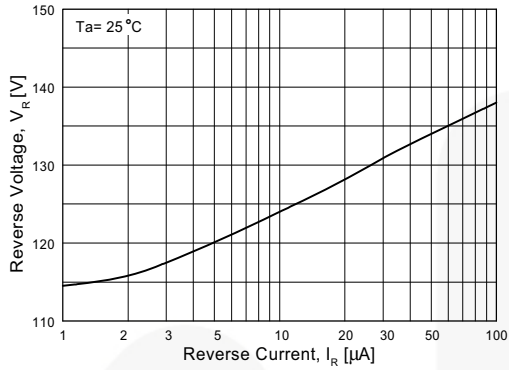

Figure 1. Reverse Voltage vs. Reverse Current  
BV - 1.0 to 100  $\mu$ A

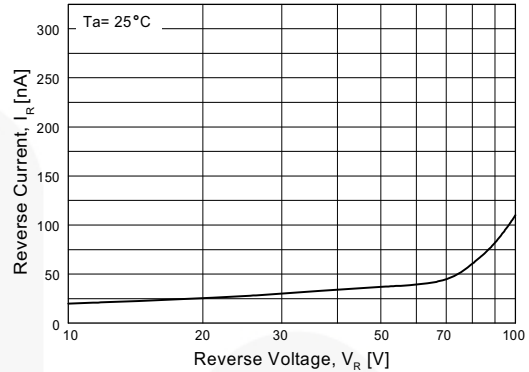

Figure 2. Reverse Current vs. Reverse Voltage  
IR - 10 to 100 V

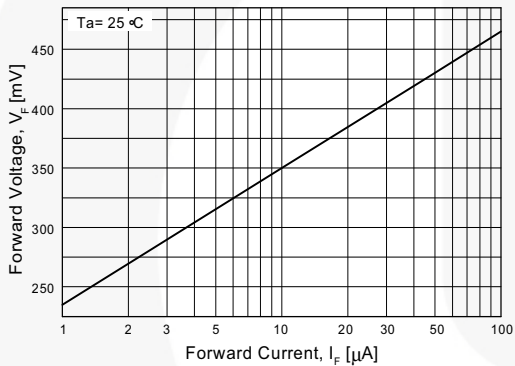

Figure 3. Forward Voltage vs. Forward Current  
VF - 1.0 to 100  $\mu$ A

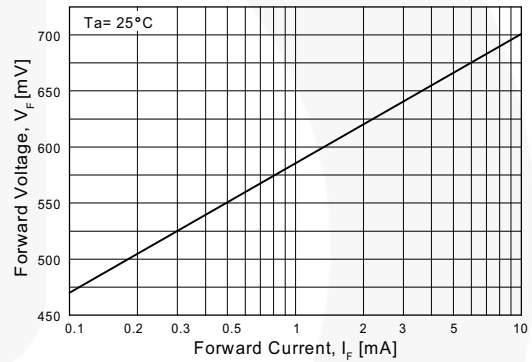

Figure 4. Forward Voltage vs. Forward Current  
VF - 0.1 to 10 mA

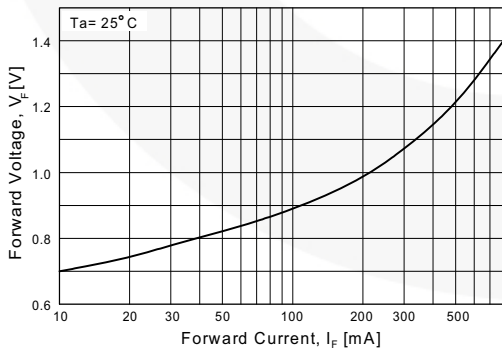

Figure 5. Forward Voltage vs. Forward Current  
VF - 10 to 800 mA

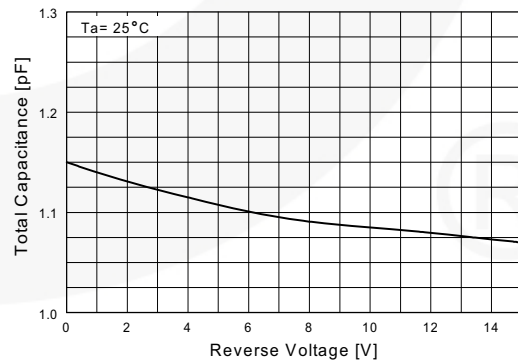

Figure 6. Total Capacitance vs. Reverse Voltage

Typical Performance Characteristics (Continued)

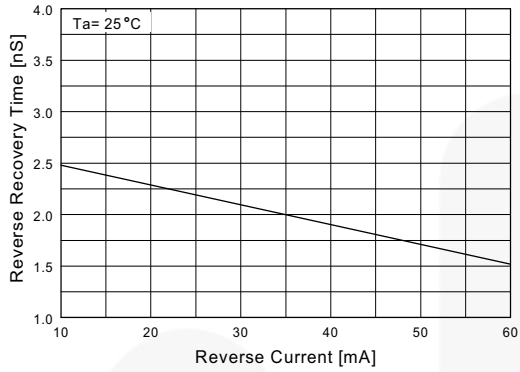

Figure 7. Reverse Recovery Time vs. Reverse Current  
TRR - IR 10 mA to 60 mA

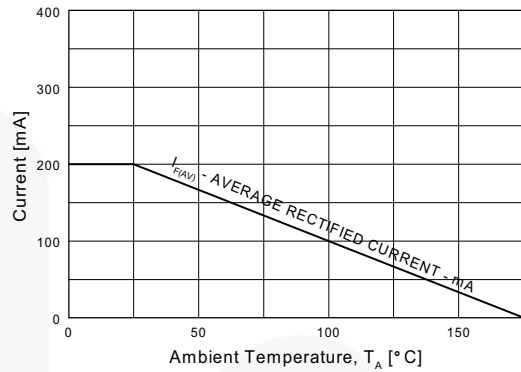

Figure 8. Average Rectified Current ( $I_{F(AV)}$ )  
vs. Ambient Temperature ( $T_A$ )

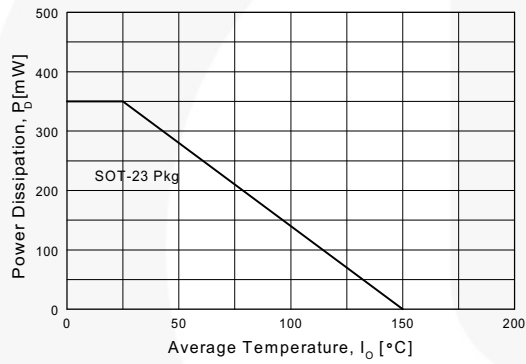
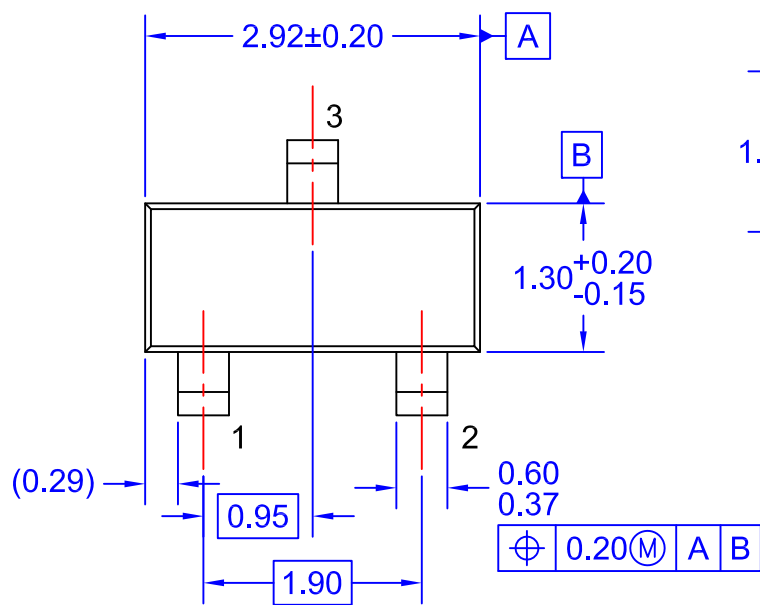
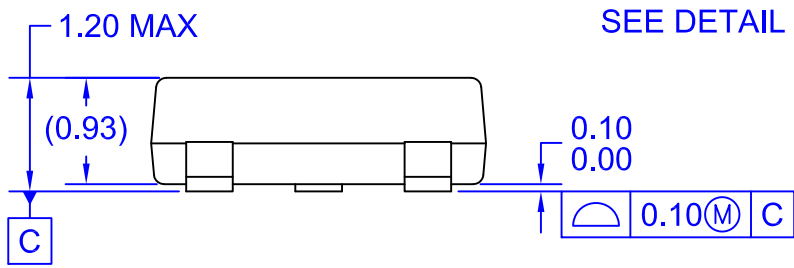

Figure 9. Power Derating Curve



LAND PATTERN  
RECOMMENDATION



SEE DETAIL A

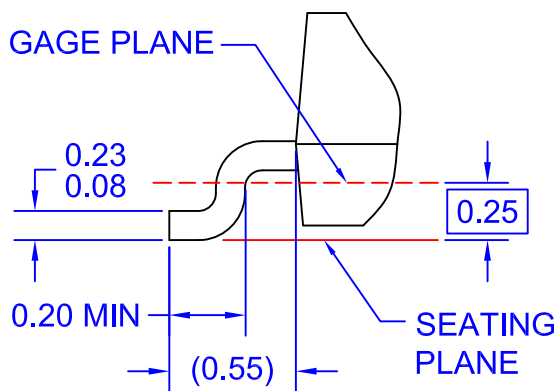

**DETAIL A**  
SCALE: 2X

NOTES: UNLESS OTHERWISE SPECIFIED

- A) REFERENCE JEDEC REGISTRATION TO-236, VARIATION AB, ISSUE H.
- B) ALL DIMENSIONS ARE IN MILLIMETERS.
- C) DIMENSIONS ARE INCLUSIVE OF BURRS, MOLD FLASH AND TIE BAR EXTRUSIONS.
- D) DIMENSIONING AND TOLERANCING PER ASME Y14.5M - 2009.
- E) DRAWING FILE NAME: MA03DREV12



ON Semiconductor and  are trademarks of Semiconductor Components Industries, LLC dba ON Semiconductor or its subsidiaries in the United States and/or other countries. ON Semiconductor owns the rights to a number of patents, trademarks, copyrights, trade secrets, and other intellectual property. A listing of ON Semiconductor's product/patent coverage may be accessed at [www.onsemi.com/site/pdf/Patent-Marking.pdf](http://www.onsemi.com/site/pdf/Patent-Marking.pdf). ON Semiconductor reserves the right to make changes without further notice to any products herein. ON Semiconductor makes no warranty, representation or guarantee regarding the suitability of its products for any particular purpose, nor does ON Semiconductor assume any liability arising out of the application or use of any product or circuit, and specifically disclaims any and all liability, including without limitation special, consequential or incidental damages. Buyer is responsible for its products and applications using ON Semiconductor products, including compliance with all laws, regulations and safety requirements or standards, regardless of any support or applications information provided by ON Semiconductor. "Typical" parameters which may be provided in ON Semiconductor data sheets and/or specifications can and do vary in different applications and actual performance may vary over time. All operating parameters, including "Typicals" must be validated for each customer application by customer's technical experts. ON Semiconductor does not convey any license under its patent rights nor the rights of others. ON Semiconductor products are not designed, intended, or authorized for use as a critical component in life support systems or any FDA Class 3 medical devices or medical devices with a same or similar classification in a foreign jurisdiction or any devices intended for implantation in the human body. Should Buyer purchase or use ON Semiconductor products for any such unintended or unauthorized application, Buyer shall indemnify and hold ON Semiconductor and its officers, employees, subsidiaries, affiliates, and distributors harmless against all claims, costs, damages, and expenses, and reasonable attorney fees arising out of, directly or indirectly, any claim of personal injury or death associated with such unintended or unauthorized use, even if such claim alleges that ON Semiconductor was negligent regarding the design or manufacture of the part. ON Semiconductor is an Equal Opportunity/Affirmative Action Employer. This literature is subject to all applicable copyright laws and is not for resale in any manner.

## PUBLICATION ORDERING INFORMATION

### LITERATURE FULFILLMENT:

Literature Distribution Center for ON Semiconductor  
19521 E. 32nd Pkwy, Aurora, Colorado 80011 USA  
**Phone:** 303-675-2175 or 800-344-3860 Toll Free USA/Canada  
**Fax:** 303-675-2176 or 800-344-3867 Toll Free USA/Canada  
**Email:** [orderlit@onsemi.com](mailto:orderlit@onsemi.com)

**N. American Technical Support:** 800-282-9855 Toll Free  
USA/Canada  
**Europe, Middle East and Africa Technical Support:**  
Phone: 421 33 790 2910  
**Japan Customer Focus Center**  
Phone: 81-3-5817-1050

**ON Semiconductor Website:** [www.onsemi.com](http://www.onsemi.com)  
**Order Literature:** <http://www.onsemi.com/orderlit>  
For additional information, please contact your local  
Sales Representative

# Mouser Electronics

Authorized Distributor

Click to View Pricing, Inventory, Delivery & Lifecycle Information:

[ON Semiconductor:](#)

[MMBD4148CC](#)