

T322 and T323 Series MIL-PRF-49137/1 and 5 (CX01 and CX05 Style)

Overview

The T322 and T323 (CX01 and CX05) capacitors are a complete line of extended range molded solid tantalum capacitors designed specifically for high-speed automatic insertion applications. These capacitors offer an extremely high capacitance-to-volume ratio while still maintaining excellent performance characteristics. Supplied in six axial lead tubular case sizes, these capacitors are ideally suited for use in printed wiring boards and all applications requiring a high degree of packaging density. These capacitors can be supplied in bulk packaging or lead-taped on reels. The T322/T323 capacitor dimensions and tight lead wire-to-body concentricity permit installation by the same automatic insertion equipment used for diodes and resistors.

These capacitors are available in working voltages of 2, 4, 6, 10, 15, 20, 25, 35, and 50 volts. The operating temperature ranges from -55°C to +85°C at full rated voltage and with 2/3 85°C rated voltage at 125°C. The gold-colored epoxy permits laser marking with outstanding permanency and legibility. T323 capacitors are qualified under MIL-PRF-49137/1 and 5 as Military Style CX01 and CX05.

Benefits

- Taped and reeled per EIA Specification RS-296
- Laser-marked case
- Qualified to MIL-PRF-49137/1 and 5 (CX01 and CX05 Style)
- Capacitance values of 0.1 to 330 μ F
- Tolerances of $\pm 5\%$, $\pm 10\%$ and $\pm 20\%$ (M and K only tolerances available for T323 Series)
- Voltage rating of 2 – 50 VDC
- Operating temperature range of -55°C to +85°C
- Case sizes: A, B, C, D, E, F

Applications

Typical applications include decoupling, blocking, bypassing and filtering in commercial computers, data processing, communications, and other electronic equipment. This product is well-suited for decoupling required by high speed computers due to its low ESR/impedance at high frequencies.

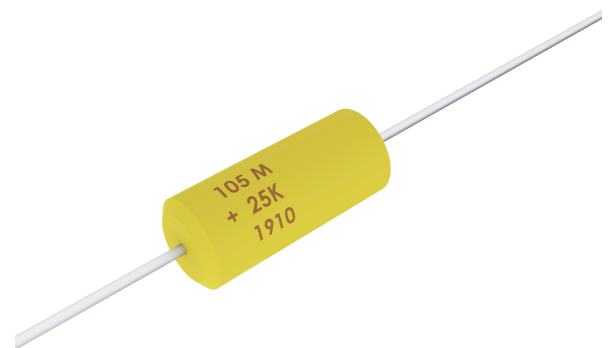

Ordering Information

T	32X	A	105	M	035	A	T	
Capacitor Class	Series	Case Size	Capacitance Code (pF)	Capacitance Tolerance	Rated Voltage (VDC)	Failure Rate/Military Product	Termination Finish	Packaging
T = Tantalum	Axial molded polar solid tantalum. Insert appropriate number to replace letter "X" = 322 or 323 (CX01 or CX05).	A B C D E F	First two digits represent significant figures. Third digit specifies number of zeros to follow.	J = $\pm 5\%^*$ K = $\pm 10\%$ M = $\pm 20\%$	002 = 2 004 = 4 006 = 6 010 = 10 015 = 15 020 = 20 025 = 25 035 = 35 050 = 50	Not Applicable	S = Standard (solder-coated nickel) T = 100% tin (Sn)- plated	Blank = Bulk 7200 = Reel

* J Tolerance available in T322 series only

MIL-PRF-49137/1/5 (CX01 and CX05 Style)

CX	05	D	475	K
Capacitor Class	Series	Rated Voltage (VDC)	Capacitance Code (pF)	Capacitance Tolerance
CX = MIL-PRF	01 = T323 05 = T323	D = 6 F = 10 H = 15 J = 20 K = 25 M = 35 N = 50	First two digits represent significant figures. Third digit specifies number of zeros to follow.	K = $\pm 10\%$ M = $\pm 20\%$

Performance Characteristics

Item	Performance Characteristics
Operating Temperature	-55°C to 125°C
Rated Capacitance Range	0.1 – 330 μ F at 120 Hz/25°C
Capacitance Tolerance	J Tolerance (5%), K Tolerance (10%), M Tolerance (20%)
Rated Voltage Range	2 – 50 V
DF (120 Hz at 25°C)	Refer to Part Number Electrical Specification Table
ESR and Impedance (100 kHz at 25°C)	Refer to Part Number Electrical Specification Table (for reference only)
Leakage Current	Refer to Part Number Electrical Specification Table (rated voltage up to +85°C and 2/3 of rated voltage applied at 125°C)

Dimensions – Inches (Millimeters)

Metric will govern

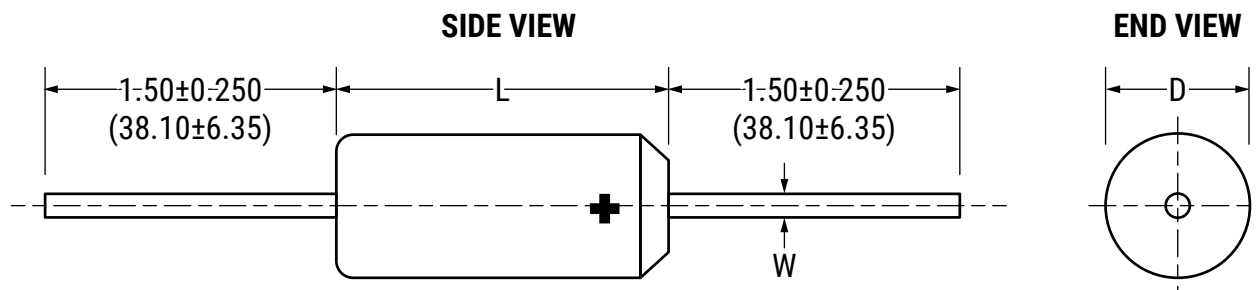

Case Size	D Maximum	L Maximum	W
A	0.095 (2.41)	0.260 (6.60)	0.020 (0.51)
B	0.110 (2.79)	0.290 (7.37)	0.020 (0.51)
C	0.180 (4.57)	0.345 (8.76)	0.020 (0.51)
D	0.180 (4.57)	0.420 (10.67)	0.020 (0.51)
E	0.280 (7.11)	0.530 (13.46)	0.025 (0.64)
F	0.300 (7.62)	0.710 (18.03)	0.025 (0.64)

Table 1 – Ratings & Part Number Reference

Rated Voltage (V) 85°C	Rated Cap µF	Case Code/ Case Size	KEMET Part Number (See below for part options)	DC Leakage µA at 25°C Max/5 Minimum	DF % at 25°C 120 Hz Maximum	CX01 & CX05 Capacitors per MIL-PRF-49137/1 & 5	
						Military Part Number	KEMET Part Number
2	6.8	A	T322A685(1)002A(2)	0.5	10		
2	8.2	A	T322A825(1)002A(2)	0.5	10		
2	10.0	A	T322A106(1)002A(2)	0.5	10		
2	12.0	B	T322B126(1)002A(2)	0.5	10		
2	15.0	B	T322B156(1)002A(2)	0.5	10		
2	18.0	B	T322B186(1)002A(2)	0.5	10		
2	22.0	B	T322B226(1)002A(2)	0.5	10		
2	27.0	B	T322B276(1)002A(2)	0.5	10		
2	33.0	B	T322B336(1)002A(2)	0.5	10		
2	39.0	C	T322C396(1)002A(2)	0.6	10		
2	47.0	C	T322C476(1)002A(2)	0.8	10		
2	56.0	C	T322C566(1)002A(2)	0.9	10		
2	68.0	C	T322C686(1)002A(2)	1.1	10		
4	4.7	A	T322A475(1)004A(2)	0.5	8		
4	5.6	A	T322A565(1)004A(2)	0.5	8		
4	6.8	A	T322A685(1)002A(2)	0.5	8		
4	8.2	B	T322B825(1)004A(2)	0.5	8		
4	10.0	B	T322B106(1)004A(2)	0.5	8		
4	12.0	B	T322B126(1)004A(2)	0.5	8		
4	15.0	B	T322B156(1)004A(2)	0.5	8		
4	18.0	B	T322B186(1)004A(2)	0.6	8		
4	22.0	B	T322B226(1)004A(2)	0.7	8		
4	27.0	C	T322C276(1)004A(2)	0.9	8		
4	33.0	C	T322C336(1)004A(2)	1.1	8		
4	39.0	C	T322C396(1)004A(2)	1.2	8		
4	47.0	C	T322C476(1)004A(2)	1.5	8		
4	56.0	D	T322D566(1)004A(2)	1.8	8		
4	68.0	D	T322D686(1)004A(2)	2.2	8		
6	3.3	A	T322A335(1)006A(2)	0.5	4		
6	3.9	A	T322A395(1)006A(2)	0.5	4		
6	4.7	A	T322A475J006A(2)	0.5	4		
6	4.7	A	T322A475K006A(2)	0.5	4	CX05D475K	T323A475K006A(2)
6	4.7	A	T322A475M006A(2)	0.5	4	CX05D475M	T323A475M006A(2)
6	5.6	B	T322B565J006A(2)	0.5	4		
6	5.6	B	T322B565K006A(2)	0.5	4	CX01D565K	T323B565K006A(2)
6	5.6	B	T322B565M006A(2)	0.5	4	CX01D565M	T323B565M006A(2)
6	6.8	B	T322B685J006A(2)	0.5	6		
6	6.8	B	T322B685K006A(2)	0.5	6	CX01D685K	T323B685K006A(2)
6	6.8	B	T322B685M006A(2)	0.5	6	CX01D685M	T323B685M006A(2)
6	8.2	B	T322B825J006A(2)	0.5	6		
6	8.2	B	T322B825K006A(2)	0.5	6	CX01D825K	T323B825K006A(2)
6	8.2	B	T322B825M006A(2)	0.5	6	CX01D825M	T323B825M006A(2)
6	10.0	B	T322B106J006A(2)	0.5	6		
6	10.0	B	T322B106K006A(2)	0.5	6	CX01D106K	T323B106K006A(2)
6	10.0	B	T322B106M006A(2)	0.5	6	CX01D106M	T323B106M006A(2)
6	12.0	B	T322B126J006A(2)	0.6	6		
6	12.0	B	T322B126K006A(2)	0.6	6	CX01D126K	T323B126K006A(2)
6	12.0	B	T322B126M006A(2)	0.6	6	CX01D126M	T323B126M006A(2)
6	15.0	B	T322B156J006A(2)	0.7	6		
6	15.0	B	T322B156K006A(2)	0.7	6	CX05D156K	T323B156K006A(2)
6	15.0	B	T322B156M006A(2)	0.7	6	CX05D156M	T323B156M006A(2)
6	18.0	C	T322C186(1)006A(2)	0.9	6		
6	22.0	C	T322C226(1)006A(2)	1.1	6		
6	27.0	C	T322C276(1)006A(2)	1.3	6		
6	33.0	C	T322C336J006A(2)	1.5	6		
6	33.0	C	T322C336K006A(2)	1.5	6	CX05D336K	T323C336K006A(2)
(V) 85°C	µF	Case Code/ Case Size	(see below for part options)	µA at 25°C Max/5 Minimum	% at 25°C 120 Hz Maximum	Military Part Number	KEMET Part Number
Rated Voltage	Rated Cap		KEMET Part Number	DC Leakage	DF	CX01 & CX05 Capacitors per MIL-PRF-49137/1 & 5	

(1) To complete KEMET part number, insert M for ±20%, K for ±10% or J for 5%. Designates capacitance tolerance.

(2) To complete KEMET part number, insert T = 100% Matte Tin (Sn) Plated, S = Standard Solder coated (SnPb 5% Pb minimum).

Designates termination finish.

Table 1 – Ratings & Part Number Reference cont.

Rated Voltage	Rated Cap	Case Code/ Case Size	KEMET Part Number	DC Leakage	DF	CX01 & CX05 Capacitors per MIL-PRF-49137/1 & 5	
(V) 85°C	µF		(See below for part options)	µA at 25°C Max/5 Minimum	% at 25°C 120 Hz Maximum	Military Part Number	KEMET Part Number
6	33.0	C	T322C336M006A(2)	1.5	6	CX05D336M	T323C336M006A(2)
6	39.0	D	T322D396(1)006A(2)	1.9	6		
6	47.0	D	T322D476J006A(2)	2.3	6		
6	47.0	D	T322D476K006A(2)	2.3	6	CX05D476K	T323D476K006A(2)
6	47.0	D	T322D476M006A(2)	2.3	6	CX05D476M	T323D476M006A(2)
6	56.0	D	T322D566(1)006A(2)	2.7	6		
6	68.0	D	T322D686(1)006A(2)	3.3	6		
6	82.0	E	T322E826(1)006A(2)	3.9	8		
6	100.0	E	T322E107(1)006A(2)	4.8	8		
6	120.0	E	T322E127(1)006A(2)	5.0	8		
6	150.0	E	T322E157(1)006A(2)	5.0	8		
6	180.0	E	T322E187(1)006A(2)	8.6	8		
6	220.0	E	T322E227(1)006A(2)	10.0	8		
6	270.0	F	T322F277(1)006A(2)	10.0	8		
6	330.0	F	T322F337(1)006A(2)	10.0	8		
10	2.2	A	T322A225(1)010A(2)	0.5	4		
10	2.7	A	T322A275(1)010A(2)	0.5	4		
10	3.3	A	T322A335J010A(2)	0.5	4		
10	3.3	A	T322A335K010A(2)	0.5	4	CX05F335K	T323A335K010A(2)
10	3.3	A	T322A335M010A(2)	0.5	4	CX05F335M	T323A335M010A(2)
10	3.9	B	T322B395(1)010A(2)	0.5	4		
10	4.7	B	T322B475(1)010A(2)	0.5	4		
10	5.6	B	T322B565(1)010A(2)	0.5	4		
10	6.8	B	T322B685(1)010A(2)	0.5	6		
10	8.2	B	T322B825(1)010A(2)	0.7	6		
10	10.0	B	T322B106J010A(2)	0.8	6		
10	10.0	B	T322B106K010A(2)	0.8	6	CX05F106K	T323B106K010A(2)
10	10.0	B	T322B106M010A(2)	0.8	6	CX05F106M	T323B106M010A(2)
10	12.0	C	T322C126(1)010A(2)	1.0	6		
10	15.0	C	T322C156(1)010A(2)	1.2	6		
10	18.0	C	T322C186(1)010A(2)	1.4	6		
10	22.0	C	T322C226J010A(2)	1.5	6		
10	22.0	C	T322C226K010A(2)	1.5	6	CX05F226K	T323C226K010A(2)
10	22.0	C	T322C226M010A(2)	1.5	6	CX05F226M	T323C226M010A(2)
10	27.0	D	T322D276J010A(2)	2.2	6		
10	27.0	D	T322D276K010A(2)	2.2	6	CX05F276K	T323D276K010A(2)
10	27.0	D	T322D276M010A(2)	2.2	6	CX05F276M	T323D276M010A(2)
10	33.0	D	T322D336J010A(2)	2.6	6		
10	33.0	D	T322D336K010A(2)	2.6	6	CX05F336K	T323D336K010A(2)
10	33.0	D	T322D336M010A(2)	2.6	4	CX05F336M	T323D336M010A(2)
10	39.0	D	T322D396J010A(2)	3.1	6		
10	39.0	D	T322D396K010A(2)	3.1	6	CX05F396K	T323D396K010A(2)
10	39.0	D	T322D396M010A(2)	3.1	6	CX05F396M	T323D396M010A(2)
10	47.0	D	T322D476J010A(2)	3.8	6		
10	47.0	D	T322D476K010A(2)	3.8	6	CX05F476K	T323D476K010A(2)
10	47.0	D	T322D476M010A(2)	3.8	6	CX05F476M	T323D476M010A(2)
10	56.0	E	T322E566(1)010A(2)	4.4	6		
10	68.0	E	T322E686(1)010A(2)	5.0	6		
10	82.0	E	T322E826(1)010A(2)	5.0	8		
10	100.0	E	T322E107(1)010A(2)	8.0	8		
10	120.0	E	T322E127(1)010A(2)	9.6	8		
10	150.0	E	T322E157(1)010A(2)	10.0	8		
10	180.0	F	T322F187(1)010A(2)	10.0	8		
10	220.0	F	T322F227(1)010A(2)	10.0	8		
15	1.5	A	T322A155(1)015A(2)	0.5	4		
15	1.8	A	T322A185(1)015A(2)	0.5	4		
(V) 85°C	µF	Case Code/ Case Size	(see below for part options)	µA at 25°C Max/5 Minimum	% at 25°C 120 Hz Maximum	Military Part Number	KEMET Part Number
Rated Voltage	Rated Cap	Case Code/ Case Size	KEMET Part Number	DC Leakage	DF	CX01 & CX05 Capacitors per MIL-PRF-49137/1 & 5	

(1) To complete KEMET part number, insert M for ±20%, K for ±10% or J for 5%. Designates capacitance tolerance.

(2) To complete KEMET part number, insert T = 100% Matte Tin (Sn) Plated, S = Standard Solder coated (SnPb 5% Pb minimum).

Designates termination finish.

Table 1 – Ratings & Part Number Reference cont.

Rated Voltage	Rated Cap	Case Code/ Case Size	KEMET Part Number	DC Leakage	DF	CX01 & CX05 Capacitors per MIL-PRF-49137/1 & 5	
(V) 85°C	µF		(See below for part options)	µA at 25°C Max/5 Minimum	% at 25°C 120 Hz Maximum	Military Part Number	KEMET Part Number
Rated Voltage	Rated Cap	Case Code/ Case Size	KEMET Part Number	DC Leakage	DF	CX01 & CX05 Capacitors per MIL-PRF-49137/1 & 5	
15	2.2	A	T322A225J015A(2)	0.5	4		
15	2.2	A	T322A225K015A(2)	0.5	4	CX05H225K	T323A225K015A(2)
15	2.2	A	T322A225M015A(2)	0.5	4	CX05H225M	T323A225M015A(2)
15	2.7	B	T322B275(1)015A(2)	0.5	4		
15	3.3	B	T322B335(1)015A(2)	0.5	4		
15	3.9	B	T322B395(1)015A(2)	0.5	4		
15	4.7	B	T322B475(1)015A(2)	0.6	4		
15	5.6	B	T322B565(1)015A(2)	0.7	4		
15	6.8	B	T322B685J015A(2)	0.8	6		
15	6.8	B	T322B685K015A(2)	0.8	6	CX05H685K	T323B685K015A(2)
15	6.8	B	T322B685M015A(2)	0.8	6	CX05H685M	T323B685M015A(2)
15	8.2	C	T322C825(1)015A(2)	1.0	6		
15	10.0	C	T322C106(1)015A(2)	1.2	6		
15	12.0	C	T322C126(1)015A(2)	1.4	6		
15	15.0	C	T322C156J015A(2)	1.5	6		
15	15.0	C	T322C156K015A(2)	1.5	6	CX05H156K	T323C156K015A(2)
15	15.0	C	T322C156M015A(2)	1.5	6	CX05H156M	T323C156M015A(2)
15	18.0	D	T322D186(1)015A(2)	2.2	6		
15	22.0	D	T322D226J015A(2)	2.6	6		
15	22.0	D	T322D226K015A(2)	2.6	6	CX06H226K	T323D226K015A(2)
15	22.0	D	T322D226M015A(2)	2.6	6	CX06H226M	T323D226M015A(2)
15	27.0	D	T322D276(1)015A(2)	3.2	6		
15	33.0	D	T322D336J015A(2)	4.0	6		
15	33.0	D	T322D336K015A(2)	4.0	6	CX05H336K	T323D336K015A(2)
15	33.0	D	T322D336M015A(2)	4.0	6	CX05H336M	T323D336M015A(2)
15	39.0	E	T322E396(1)015A(2)	4.7	6		
15	47.0	E	T322E476(1)015A(2)	5.0	6		
15	56.0	E	T322E566(1)015A(2)	6.7	6		
15	68.0	E	T322E686(1)015A(2)	8.2	6		
15	82.0	E	T322E826(1)015A(2)	9.8	8		
15	100.0	E	T322E107(1)015A(2)	10.0	8		
15	120.0	F	T322F127(1)015A(2)	10.0	8		
15	150.0	F	T322F157(1)015A(2)	10.0	8		
20	1.0	A	T322A105(1)020A(2)	0.5	4		
20	1.2	A	T322A125(1)020A(2)	0.5	4		
20	1.5	A	T322A155J020A(2)	0.5	4		
20	1.5	A	T322A155K020A(2)	0.5	4	CX05J155K	T323A155K020A(2)
20	1.5	A	T322A155M020A(2)	0.5	4	CX05J155M	T323A155M020A(2)
20	1.8	B	T322B185(1)020A(2)	0.5	4		
20	2.2	B	T322B225(1)020A(2)	0.5	4		
20	2.7	B	T322B275(1)020A(2)	0.5	4		
20	3.3	B	T322B335(1)020A(2)	0.5	4		
20	3.9	B	T322B395(1)020A(2)	0.6	4		
20	4.7	B	T322B475J020A(2)	0.8	4		
20	4.7	B	T322B475K020A(2)	0.8	4	CX05J475K	T323B475K020A(2)
20	4.7	B	T322B475M020A(2)	0.8	4	CX05J475M	T323B475M020A(2)
20	5.6	C	T322C565(1)020A(2)	0.9	4		
20	6.8	C	T322C685(1)020A(2)	1.1	6		
20	8.2	C	T322C825(1)020A(2)	1.3	6		
20	10.0	C	T322C106(1)020A(2)	1.6	6		
20	12.0	D	T322D126J020A(2)	1.9	6		
20	12.0	D	T322D126K020A(2)	1.9	6	CX05J126K	T323D126K020A(2)
20	12.0	D	T322D126M020A(2)	1.9	6	CX05J126M	T323D126M020A(2)
20	15.0	D	T322D156J020A(2)	2.4	6		
20	15.0	D	T322D156K020A(2)	2.4	6	CX05J156K	T323D156K020A(2)
20	15.0	D	T322D156M020A(2)	2.4	6	CX05J156M	T323D156M020A(2)
(V) 85°C	µF	Case Code/ Case Size	(see below for part options)	µA at 25°C Max/5 Minimum	% at 25°C 120 Hz Maximum	Military Part Number	KEMET Part Number
Rated Voltage	Rated Cap	Case Code/ Case Size	KEMET Part Number	DC Leakage	DF	CX01 & CX05 Capacitors per MIL-PRF-49137/1 & 5	

(1) To complete KEMET part number, insert M for ±20%, K for ±10% or J for 5%. Designates capacitance tolerance.

(2) To complete KEMET part number, insert T = 100% Matte Tin (Sn) Plated, S = Standard Solder coated (SnPb 5% Pb minimum).

Designates termination finish.

Table 1 – Ratings & Part Number Reference cont.

Rated Voltage (V) 85°C	Rated Cap µF	Case Code/ Case Size	KEMET Part Number (See below for part options)	DC Leakage µA at 25°C Max/5 Minimum	DF % at 25°C 120 Hz Maximum	CX01 & CX05 Capacitors per MIL-PRF-49137/1 & 5	
						Military Part Number	KEMET Part Number
20	18.0	D	T322D186(1)020A(2)	2.9	6		
20	22.0	D	T322D226(1)020A(2)	3.5	6		
20	27.0	E	T322E276(1)020A(2)	4.3	6		
20	33.0	E	T322E336(1)020A(2)	5.0	6		
20	39.0	E	T322E396(1)020A(2)	6.2	6		
20	47.0	E	T322E476(1)020A(2)	7.5	6		
20	56.0	E	T322E566(1)020A(2)	8.9	6		
20	68.0	E	T322E686(1)020A(2)	10.0	6		
20	82.0	F	T322F826(1)020A(2)	10.0	8		
20	100.0	F	T322F107(1)020A(2)	10.0	8		
20	120.0	F	T322F127(1)020A(2)	10.0	8		
25	0.47	A	T322A474(1)025A(2)	0.5	3		
25	0.56	A	T322A564(1)025A(2)	0.5	3		
25	0.68	A	T322A684(1)025A(2)	0.5	3		
25	0.82	A	T322A824(1)025A(2)	0.5	3		
25	1.0	A	T322A105J025A(2)	0.5	3		
25	1.0	A	T322A105K025A(2)	0.5	3	CX05K105K	T323A105K025A(2)
25	1.0	A	T322A105M025A(2)	0.5	3	CX05K105M	T323A105M025A(2)
25	1.2	B	T322B125(1)025A(2)	0.5	3		
25	1.5	B	T322B155J025A(2)	0.5	3		
25	1.5	B	T322B155K025A(2)	0.5	3	CX05K155K	T323B155K025A(2)
25	1.5	B	T322B155M025A(2)	0.5	3	CX05K155M	T323B155M025A(2)
25	1.8	B	T322B185J025A(2)	0.5	3		
25	1.8	B	T322B185K025A(2)	0.5	3	CX05K185K	T323B185K025A(2)
25	1.8	B	T322B185M025A(2)	0.5	3	CX05K185M	T323B185M025A(2)
25	2.2	B	T322B225J025A(2)	0.5	3		
25	2.2	B	T322B225K025A(2)	0.5	3		
25	2.2	B	T322B225M025A(2)	0.5	3	CK05K225K	T323B225K025A(2)
25	2.2	B	T322B225M025A(2)	0.5	3	CK05K225M	T323B225M025A(2)
25	2.7	B	T322B275(1)025A(2)	0.5	3		
25	3.3	B	T322B335J025A(2)	0.7	3		
25	3.3	B	T322B335K025A(2)	0.7	3	CX05K335K	T323B335K025A(2)
25	3.3	B	T322B335M025A(2)	0.7	3	CX05K335M	T323B335M025A(2)
25	3.9	C	T322C395(1)025A(2)	0.8	3		
25	4.7	C	T322C475(1)025A(2)	0.9	4		
25	5.6	C	T322C565(1)025A(2)	1.1	4		
25	6.8	C	T322C685J025A(2)	1.4	4		
25	6.8	C	T322C685K025A(2)	1.4	4	CX05K685K	T323C685K025A(2)
25	6.8	C	T322C685M025A(2)	1.4	4	CX05K685M	T323C685M025A(2)
25	8.2	C	T322C825(1)025A(2)	1.4	4		
25	10.0	C	T322C106J025A(2)	1.5	4		
25	10.0	C	T322C106K025A(2)	1.5	4	CX05K106K	T323C106K025A(2)
25	10.0	C	T322C106M025A(2)	1.5	4	CX05K106M	T323C106M025A(2)
25	12.0	D	T322D126(1)025A(2)	2.4	4		
25	15.0	D	T322D156(1)025A(2)	3.0	4		
25	18.0	E	T322E186(1)025A(2)	3.6	6		
25	22.0	E	T322E226(1)025A(2)	4.4	6		
25	27.0	E	T322E276(1)025A(2)	5.4	6		
25	33.0	E	T322E336(1)025A(2)	6.6	6		
25	39.0	E	T322E396(1)025A(2)	7.9	6		
25	47.0	E	T322E476(1)025A(2)	9.4	6		
25	56.0	F	T322F566(1)025A(2)	10.0	6		
25	68.0	F	T322F686(1)025A(2)	10.0	6		
35	0.1	A	T322A104(1)035A(2)	0.5	3		
35	0.12	A	T322A124(1)035A(2)	0.5	3		
35	0.15	A	T322A154(1)035A(2)	0.5	3		
35	0.18	A	T322A184(1)035A(2)	0.5	3		
(V) 85°C	µF	Case Code/ Case Size	(see below for part options)	µA at 25°C Max/5 Minimum	% at 25°C 120 Hz Maximum	Military Part Number	KEMET Part Number
Rated Voltage	Rated Cap		KEMET Part Number	DC Leakage	DF		

(1) To complete KEMET part number, insert M for ±20%, K for ±10% or J for 5%. Designates capacitance tolerance.

(2) To complete KEMET part number, insert T = 100% Matte Tin (Sn) Plated, S = Standard Solder coated (SnPb 5% Pb minimum).

Designates termination finish.

Table 1 – Ratings & Part Number Reference cont.

Rated Voltage	Rated Cap	Case Code/ Case Size	KEMET Part Number	DC Leakage	DF	CX01 & CX05 Capacitors per MIL-PRF-49137/1 & 5	
(V) 85°C	µF		(See below for part options)	µA at 25°C Max/5 Minimum	% at 25°C 120 Hz Maximum	Military Part Number	KEMET Part Number
35	0.22	A	T322A224(1)035A(2)	0.5	3		
35	0.27	A	T322A274(1)035A(2)	0.5	3		
35	0.33	A	T322A334J035A(2)	0.5	3		
35	0.33	A	T322A334K035A(2)	0.5	3	CX05M334K	T323A334K035A(2)
35	0.33	A	T322A334M035A(2)	0.5	3	CX05M334M	T323A334M035A(2)
35	0.39	A	T322A394(1)035A(2)	0.5	3		
35	0.47	A	T322A474J035A(2)	0.5	3		
35	0.47	A	T322A474K035A(2)	0.5	3	CX05M474K	T323A474K035A(2)
35	0.47	A	T322A474M035A(2)	0.5	3	CX05M474M	T323A474M035A(2)
35	0.56	B	T322B564J035A(2)	0.5	3		
35	0.56	B	T322B564K035A(2)	0.5	3	CX01M564K	T323B564K035A(2)
35	0.56	B	T322B564M035A(2)	0.5	3	CX01M564M	T323B564M035A(2)
35	0.68	B	T322B684J035A(2)	0.5	3		
35	0.68	B	T322B684K035A(2)	0.5	3	CX01M684K	T323B684K035A(2)
35	0.68	B	T322B684M035A(2)	0.5	3	CX01M684M	T323B684M035A(2)
35	0.82	B	T322B824J035A(2)	0.5	3		
35	0.82	B	T322B824K035A(2)	0.5	3	CX01M824K	T323B824K035A(2)
35	0.82	B	T322B824M035A(2)	0.5	3	CX01M824M	T323B824M035A(2)
35	1.0	B	T322B105J035A(2)	0.5	3		
35	1.0	B	T322B105K035A(2)	0.5	3	CX01M105K	T323B105K035A(2)
35	1.0	B	T322B105M035A(2)	0.5	3	CX01M105M	T323B105M035A(2)
35	1.2	B	T322B125J035A(2)	0.5	3		
35	1.2	B	T322B125K035A(2)	0.5	3	CX01M125K	T323B125K035A(2)
35	1.2	B	T322B125M035A(2)	0.5	3	CX01M125M	T323B125M035A(2)
35	1.5	B	T322B155J035A(2)	0.5	3		
35	1.5	B	T322B155K035A(2)	0.5	3	CX05M155K	T323B155K035A(2)
35	1.5	B	T322B155M035A(2)	0.5	3	CX05M155M	T323B155M035A(2)
35	1.8	C	T322C185(1)035A(2)	0.5	3		
35	2.2	C	T322C225(1)035A(2)	0.6	3		
35	2.7	C	T322C275(1)035A(2)	0.8	3		
35	3.3	C	T322C335J035A(2)	0.9	4		
35	3.3	C	T322C335K035A(2)	0.9	4	CX05M335K	T323C335K035A(2)
35	3.3	C	T322C335M035A(2)	0.9	4	CX05M335M	T323C335M035A(2)
35	3.9	C	T322C395J035A(2)	1.1	4		
35	3.9	C	T322C395K035A(2)	1.1	4	CX05M395K	T323C395K035A(2)
35	3.9	C	T322C395M035A(2)	1.1	4	CX05M395M	T323C395M035A(2)
35	4.7	C	T322C475J035A(2)	1.3	4		
35	4.7	C	T322C475K035A(2)	1.3	4	CX05M475K	T323C475K035A(2)
35	4.7	C	T322C475M035A(2)	1.3	4	CX05M475M	T323C475M035A(2)
35	5.6	D	T322C565M035A(2)	1.6	4		
35	6.8	D	T322D685J035A(2)	1.9	4		
35	6.8	D	T322D685K035A(2)	1.9	4	CX05M685K	T323D685K035A(2)
35	6.8	D	T322D685M035A(2)	1.9	4	CX05M685M	T323D685M035A(2)
35	8.2	D	T322D825(1)035A(2)	2.3	4		
35	10.0	D	T322D106J035A(2)	2.8	4		
35	10.0	D	T322D106K035A(2)	2.8	4	CX05M106K	T323D106K035A(2)
35	10.0	D	T322D106M035A(2)	2.8	4	CX05M106M	T323D106M035A(2)
35	12.0	E	T322E126(1)035A(2)	3.3	4		
35	15.0	E	T322E156(1)035A(2)	4.2	6		
35	18.0	E	T322E186(1)035A(2)	5.0	6		
35	22.0	E	T322E226(1)035A(2)	6.2	6		
35	27.0	E	T322E276(1)035A(2)	7.5	6		
35	33.0	E	T322E336(1)035A(2)	9.2	6		
35	39.0	F	T322F396(1)035A(2)	10.0	6		
35	47.0	F	T322F476(1)035A(2)	10.0	6		
50	0.1	A	T322A104J050A(2)	0.5	3		
(V) 85°C	µF	Case Code/ Case Size	(see below for part options)	µA at 25°C Max/5 Minimum	% at 25°C 120 Hz Maximum	Military Part Number	KEMET Part Number
Rated Voltage	Rated Cap	Case Code/ Case Size	KEMET Part Number	DC Leakage	DF	CX01 & CX05 Capacitors per MIL-PRF-49137/1 & 5	

(1) To complete KEMET part number, insert M for ±20%, K for ±10% or J for 5%. Designates capacitance tolerance.

(2) To complete KEMET part number, insert T = 100% Matte Tin (Sn) Plated, S = Standard Solder coated (SnPb 5% Pb minimum).

Designates termination finish.

Table 1 – Ratings & Part Number Reference cont.

Rated Voltage	Rated Cap	Case Code/ Case Size	KEMET Part Number	DC Leakage	DF	CX01 & CX05 Capacitors per MIL-PRF-49137/1 & 5	
(V) 85°C	µF		(See below for part options)	µA at 25°C Max/5 Minimum	% at 25°C 120 Hz Maximum	Military Part Number	KEMET Part Number
50	0.1	A	T322A104K050A(2)	0.5	3	CX05N104K	T323A104K050A(2)
50	0.1	A	T322A104M050A(2)	0.5	3	CX05N104M	T323A104M050A(2)
50	0.12	A	T322A124(1)050A(2)	0.5	3		
50	0.15	A	T322A154J050A(2)	0.5	3		
50	0.15	A	T322A154K050A(2)	0.5	3	CX05N154K	T323A154K050A(2)
50	0.15	A	T322A154M050A(2)	0.5	3	CX05N154M	T323A154M050A(2)
50	0.18	A	T322A184(1)050A(2)	0.5	3		
50	0.22	A	T322A224J050A(2)	0.5	3		
50	0.22	A	T322A224K050A(2)	0.5	3	CX05N224K	T323A224K050A(2)
50	0.22	A	T322A224M050A(2)	0.5	3	CX05N224M	T323A224M050A(2)
50	0.27	A	T322A274(1)050A(2)	0.5	3		
50	0.33	B	T322B334J050A(2)	0.5	3		
50	0.33	B	T322B334K050A(2)	0.5	3	CX05N334K	T323B334K050A(2)
50	0.33	B	T322B334M050A(2)	0.5	3	CX05N334M	T323B334M050A(2)
50	0.39	B	T322B394J050A(2)	0.5	3		
50	0.39	B	T322B394K050A(2)	0.5	3	CX05N394K	T323B394K050A(2)
50	0.39	B	T322B394M050A(2)	0.5	3	CX05N394M	T323B394M050A(2)
50	0.47	B	T322B474J050A(2)	0.5	3		
50	0.47	B	T322B474K050A(2)	0.5	3	CX05N474K	T323B474K050A(2)
50	0.47	B	T322B474M050A(2)	0.5	3	CX05N474M	T323B474M050A(2)
50	0.56	B	T322B564(1)050A(2)	0.5	3		
50	0.68	B	T322B684J050A(2)	0.5	3		
50	0.68	B	T322B684K050A(2)	0.5	3	CX05N684K	T323B684K050A(2)
50	0.68	B	T322B684M050A(2)	0.5	3	CX05N684M	T323B684M050A(2)
50	0.82	B	T322B824(1)050A(2)	0.5	3		
50	1.0	B	T322B105J050A(2)	0.5	3		
50	1.0	B	T322B105K050A(2)	0.5	3	CX05N105K	T323B105K050A(2)
50	1.0	B	T322B105M050A(2)	0.5	3	CX05N105M	T323B105M050A(2)
50	1.2	C	T322C125(1)050A(2)	0.5	3		
50	1.5	C	T322C155J050A(2)	0.6	4		
50	1.5	C	T322C155K050A(2)	0.6	4	CX05N155K	T323C155K050A(2)
50	1.5	C	T322C155M050A(2)	0.6	4	CX05N155M	T323C155M050A(2)
50	1.8	C	T322C185(1)050A(2)	0.7	4		
50	2.2	C	T322C225J050A(2)	0.9	4		
50	2.2	C	T322C225K050A(2)	0.9	4	CX05N225K	T323C225K050A(2)
50	2.2	C	T322C225M050A(2)	0.9	4	CX05N225M	T323C225M050A(2)
50	2.7	D	T322D275(1)050A(2)	1.1	4		
50	3.3	D	T322D335J050A(2)	1.3	4		
50	3.3	D	T322D335K050A(2)	1.3	4	CX05N335K	T323D335K050A(2)
50	3.3	D	T322D335M050A(2)	1.3	4	CX05N335M	T323D335M050A(2)
50	3.9	D	T322D395(1)050A(2)	1.6	4		
50	4.7	D	T322D475J050A(2)	1.9	4		
50	4.7	D	T322D475K050A(2)	1.9	4	CX05N475K	T323D475K050A(2)
50	4.7	D	T322D475M050A(2)	1.9	4	CX05N475M	T323D475M050A(2)
50	5.6	E	T322E565(1)050A(2)	2.2	4		
50	6.8	E	T322E685(1)050A(2)	2.7	4		
50	8.2	E	T322E825(1)050A(2)	3.2	4		
50	10.0	E	T322E106(1)050A(2)	4.0	6		
50	12.0	F	T322F126(1)050A(2)	4.8	6		
50	15.0	F	T322F156(1)050A(2)	6.0	6		
50	18.0	F	T322F186(1)050A(2)	7.2	6		
50	22.0	F	T322F226(1)050A(2)	8.8	6		
(V) 85°C	µF		(see below for part options)	µA at 25°C Max/5 Minimum	% at 25°C 120 Hz Maximum	Military Part Number	KEMET Part Number
Rated Voltage	Rated Cap	Case Code/ Case Size	KEMET Part Number	DC Leakage	DF	CX01 & CX05 Capacitors per MIL-PRF-49137/1 & 5	

(1) To complete KEMET part number, insert M for ±20%, K for ±10% or J for 5%. Designates capacitance tolerance.

(2) To complete KEMET part number, insert T = 100% Matte Tin (Sn) Plated, S = Standard Solder coated (SnPb 5% Pb minimum). Designates termination finish.

Recommended Voltage Derating Guidelines

	-55°C to 85°C	85°C to 125°C
% Change in Working DC Voltage with Temperature	V_R	66% of V_R

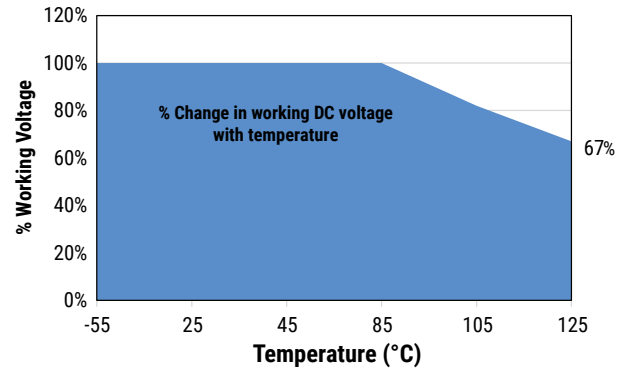

Ripple Current/Ripple Voltage

Permissible AC ripple voltage and current are related to equivalent series resistance (ESR) and the power dissipation capabilities of the device. Permissible AC ripple voltage that may be applied is limited by following criteria:

1. Dissipated power must not exceed the limits specified for the Series.
2. The positive peak AC voltage plus the DC bias voltage, if any, must not exceed the DC voltage rating of the capacitor.
3. The negative peak AC voltage in combination with bias voltage, if any, must not exceed the allowable limits specified for reverse voltage.

Thermal capacities for the various case sizes have been determined empirically and are listed below. The “ripple voltage” permissible may be calculated from the impedance and ESR data shown in the respective product section.

Temperature Compensation Multipliers for Maximum Power Dissipation		
$T \leq 25^\circ\text{C}$	$T \leq 85^\circ\text{C}$	$T \leq 125^\circ\text{C}$
1.00	0.90	0.40

T = Environmental Temperature

The maximum power dissipation rating must be reduced with increasing environmental operating temperatures. Refer to the Temperature Compensation Multiplier table for details.

Case Size	Maximum Power Dissipation (P_{max}) Watts at 25°C
A	0.060
B	0.070
C	0.080
D	0.090
E	0.100
F	0.110

Using the P_{max} of the device, the maximum allowable rms ripple current or voltage may be determined.

$$I(max) = \sqrt{P_{max}/R}$$

$$E(max) = Z \sqrt{P_{max}/R}$$

I = rms ripple current (amperes)

E = rms ripple voltage (volts)

P_{max} = maximum power dissipation (watts)

R = ESR at specified frequency (ohms)

Z = Impedance at specified frequency (ohms)

Optimum Solder Wave Profile

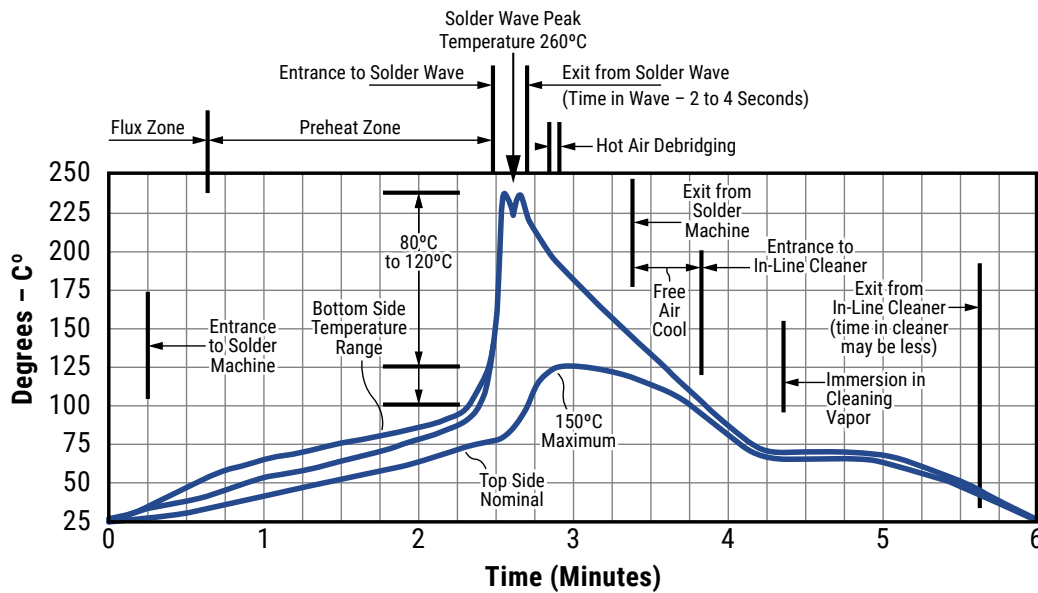

Reverse Voltage

Although these are polar capacitors, some degree of transient voltage reversal is permissible, as seen below. The capacitors should not be operated continuously in reverse mode, even within these limits.

Temperature (°C)	Percentage of Rated Voltage
+25	15
+85	5
+125	1

Construction

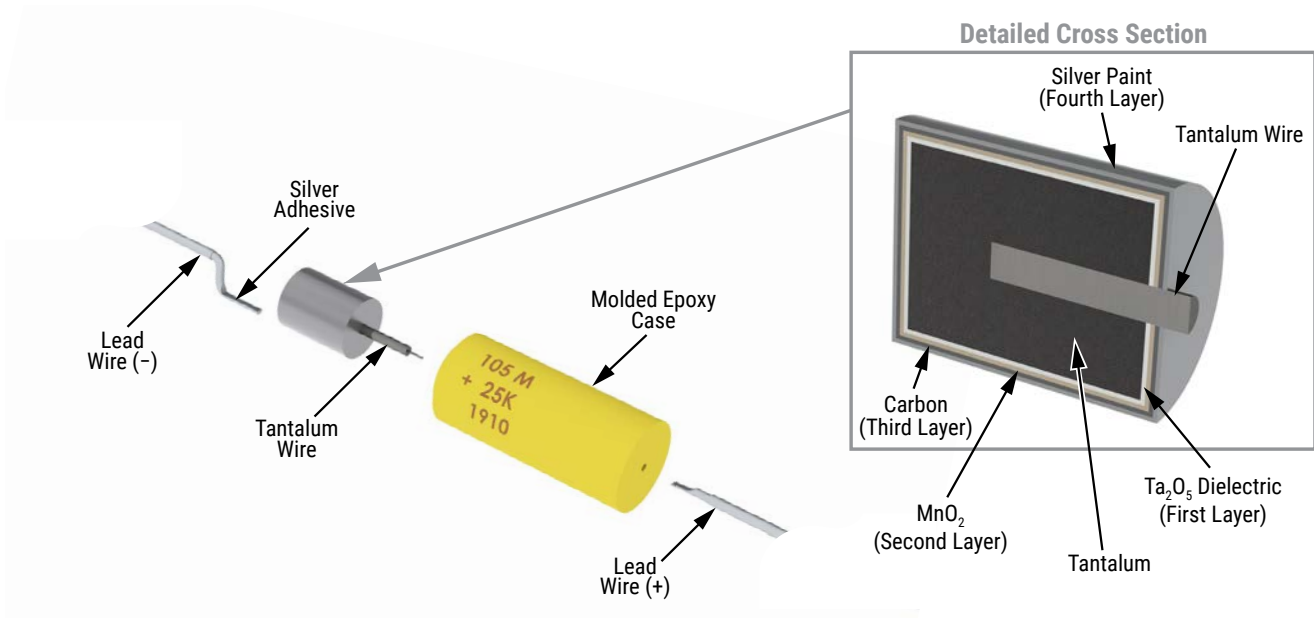

Capacitor Marking

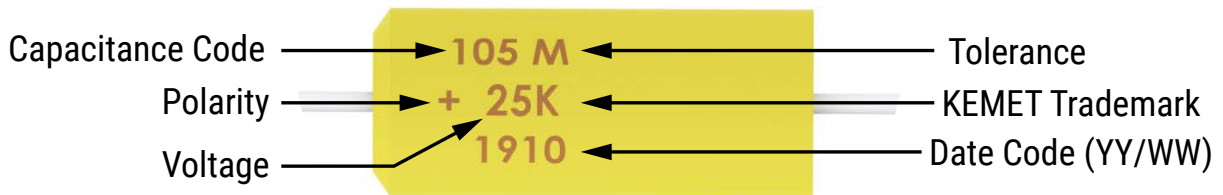

Storage

Tantalum hermetically sealed capacitors should be stored in normal working environments. While the capacitors themselves are quite robust in other environments, solderability will be degraded by exposure to high temperatures, high humidity, corrosive atmospheres, and long term storage. In addition, packaging materials will be degraded by high temperature – reels may soften or warp and tape peel force may increase. KEMET recommends that maximum storage temperature not exceed 40°C and maximum storage humidity not exceed 60% relative humidity. Temperature fluctuations should be minimized to avoid condensation on the parts and atmospheres should be free of chlorine and sulphur bearing compounds. For optimized solderability capacitors stock should be used promptly, preferably within three years of receipt.

Tape & Reel Packaging Information

KEMET offers standard reeling of Solid Tantalum Capacitors for automatic insertion or lead forming machines per EIA Specification RS-296.

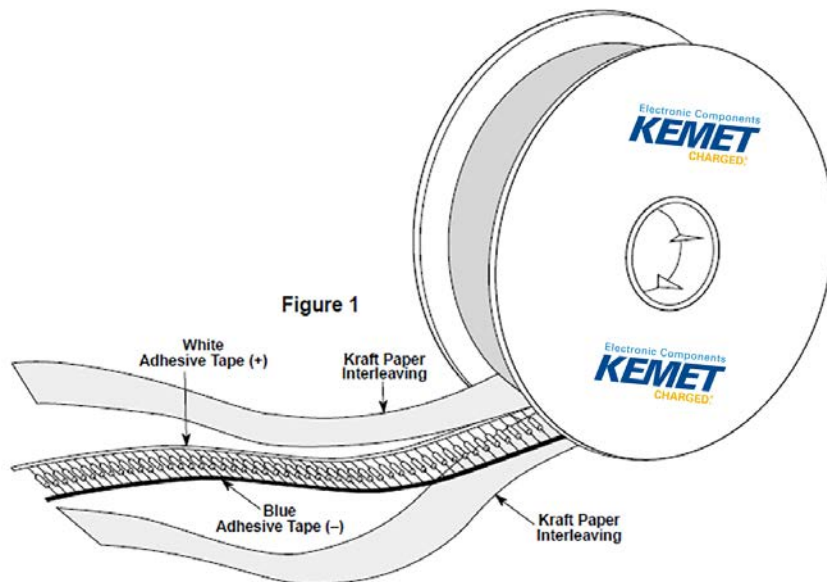

Table 2 – Packaging Quantity

Case Size	Standard Bulk Quantity	Standard Reel Quantity	Reel C-Spec	Ammo Pack Quantity	Ammo Pack C-Spec
A	300	4,500	C-7200	2,000	C-7293
B	250	4,000		2,000	Class I
C	100	2,500		1,000	C-7442
D	100	2,500		1,000	Class II
E	100	500		250	C-7443
F	100	500		250	Class III

Figure 2

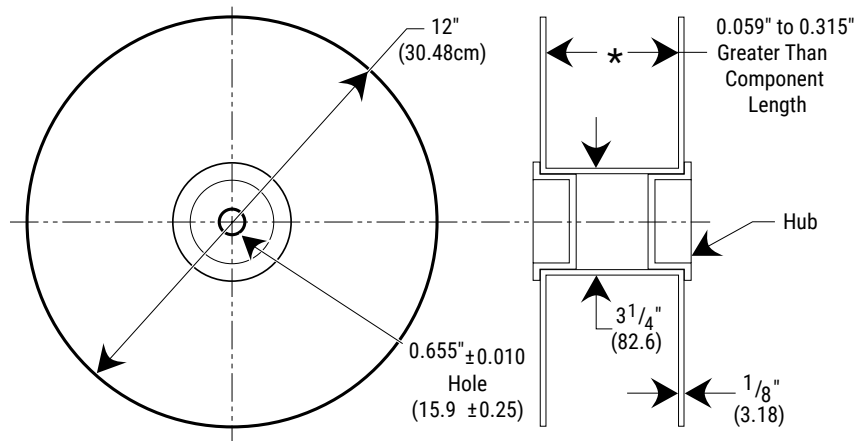

Figure 3

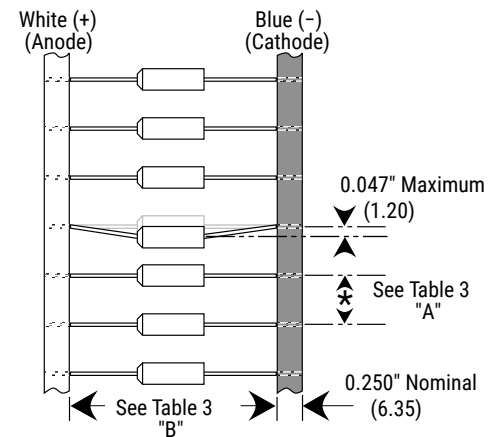

Table 3 – Tape Dimensions

Dimensions in Inches (& Millimeters)

BODY DIAMETER	A PITCH ±0.020 (0.5)	B INSIDE TAPE SPACING
≤ 0.197 (5.0)	0.200 (5.0)	2.063 (52.4) +0.079, -0.039 (+2.0, -1.0)
0.198 (5.0) to 0.394 (10.0)	0.400 or (10.0)	2.874 (73) +/0.059

Capacitors are reeled so that positive leads are oriented as shown in Figure 3. Kraft paper (50 lbs. test minimum) is inserted between the layers of capacitors wound on reels for component pitch ≤ 0.200" sizes and corrugated paper (70 lbs. test minimum), single faced is inserted for component pitch ≥ 0.400" sizes. Capacitor lead length may extend only a maximum of 0.031" (0.8 mm) beyond the tape's edges. Capacitors are centered in a row between the two tapes and will deviate only ±0.031" (0.79 mm) from the row center.

Figures 1 and 2 show the KEMET standard chipboard tape reel.

A minimum of 36" (91.5 cm) leader tape is provided at each end of the reeled capacitors.

Universal splicing clips are used to connect the tape.

KEMET Electronics Corporation Sales Offices

For a complete list of our global sales offices, please visit www.kemet.com/sales.

Disclaimer

All product specifications, statements, information and data (collectively, the "Information") in this datasheet are subject to change. The customer is responsible for checking and verifying the extent to which the Information contained in this publication is applicable to an order at the time the order is placed. All Information given herein is believed to be accurate and reliable, but it is presented without guarantee, warranty, or responsibility of any kind, expressed or implied.

Statements of suitability for certain applications are based on KEMET Electronics Corporation's ("KEMET") knowledge of typical operating conditions for such applications, but are not intended to constitute – and KEMET specifically disclaims – any warranty concerning suitability for a specific customer application or use. The Information is intended for use only by customers who have the requisite experience and capability to determine the correct products for their application. Any technical advice inferred from this Information or otherwise provided by KEMET with reference to the use of KEMET's products is given gratis, and KEMET assumes no obligation or liability for the advice given or results obtained.

Although KEMET designs and manufactures its products to the most stringent quality and safety standards, given the current state of the art, isolated component failures may still occur. Accordingly, customer applications which require a high degree of reliability or safety should employ suitable designs or other safeguards (such as installation of protective circuitry or redundancies) in order to ensure that the failure of an electrical component does not result in a risk of personal injury or property damage.

Although all product-related warnings, cautions and notes must be observed, the customer should not assume that all safety measures are indicated or that other measures may not be required.

KEMET is a registered trademark of KEMET Electronics Corporation.

Mouser Electronics

Authorized Distributor

Click to View Pricing, Inventory, Delivery & Lifecycle Information:

KEMET:

[T322A105K020AS](#) [T322A105K025AS](#) [T322A105K025AS7200](#) [T322A105M025AS7200](#) [T322A225K015AS](#)
[T322B105J035AS](#) [T322B105J050AS](#) [T322B105M035AS](#) [T322B125K035AS7200](#) [T322B156K006AS7200](#)
[T322B225J025AS](#) [T322B225K020AS](#) [T322B225K025AS](#) [T322B565K015AS](#) [T322B684K035AS](#)
[T322C106J020AS7200](#) [T322C106K015AS](#) [T322C106K020AS](#) [T322C106K025AS](#) [T322C106M020AS7200](#)
[T322C226K010AS](#) [T322C335K035AS](#) [T322C685M025AS7200](#) [T322D106M035AS](#) [T322D156K025AS7200](#)
[T322D336K010AS](#) [T322D336K015AS](#) [T322D475K050AS](#) [T322D686K006AS](#) [T322D686K006AS7200](#)
[T322E107K015AS7200](#) [T322E157K010AS7200](#) [T322E226K025AS](#) [T322E226K035AS](#) [T322E336K035AS7200](#)
[T322E476K020AS7200](#) [T322E476M020AS7200](#) [T322E686K020AS7200](#) [T322F107M020AS](#) [T322F107M020AS7200](#)
[T322F476K035AS7200](#) [T370C105M035AS6845](#) [T322A104K035AS](#) [T322A104K050AS](#) [T322A224K035AS](#)
[T322A224K050AS](#) [T322A334K035AS](#) [T322A335K010AS7200](#) [T322A474K035AS](#) [T322B105K035AS7200](#)
[T322B106K010AS](#) [T322B106K010AS7200](#) [T322B106M010AS](#) [T322B106M010AS7200](#) [T322B155K035AS7200](#)
[T322B335K015AS7200](#) [T322B335K025AS7200](#) [T322B474K050AS7200](#) [T322B475K010AS](#) [T322B475K020AS](#)
[T322B475M020AS](#) [T322C106M020AS](#) [T322C106M025AS](#) [T322C106M025AS7200](#) [T322C126M010AS](#)
[T322C156K015AS7200](#) [T322C156M010AS](#) [T322C156M010AS7200](#) [T322C226K010AS7200](#) [T322D106K035AS7200](#)
[T322D106M035AS7200](#) [T322D156K020AS7200](#) [T322D226K015AS7200](#) [T322D336M015AS](#) [T322D476K006AS](#)
[T322D566K006AS](#) [T322D685K035AS](#) [T322D825K035AS](#) [T322E107K010AS7200](#) [T322E156K035AS](#)
[T322E156K035AS7200](#) [T322F127M020AS](#) [T322F157K015AS7200](#) [T322F226K050AS7200](#) [T322F227K010AS7200](#)
[T370C475M020AS6845](#) [T322A475K006AS](#) [T322B105K035AS](#) [T322B105K050AS](#) [T322B105K050AS7200](#)
[T322B105M035AS7200](#) [T322B225K020AS7200](#) [T322B335K015AS](#) [T322B335K020AS](#) [T322B335K020AS7200](#)
[T322B335K025AS](#) [T322B475K020AS7200](#) [T322B475M020AS7200](#) [T322B685K010AS](#) [T322B685K010AS7200](#)