

- Generation V Technology
- Ultra Low On-Resistance
- P-Channel MOSFET
- SOT-23 Footprint
- Low Profile (<1.1mm)
- Available in Tape and Reel
- Fast Switching
- Lead-Free
- RoHS Compliant, Halogen-Free

HEXFET® Power MOSFET

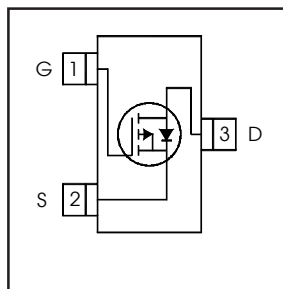

$$V_{DSS} = -20V$$

$$R_{DS(on)} = 0.60\Omega$$

Description

Fifth Generation HEXFETs from International Rectifier utilize advanced processing techniques to achieve extremely low on-resistance per silicon area. This benefit, combined with the fast switching speed and ruggedized device design that HEXFET Power MOSFETs are well known for, provides the designer with an extremely efficient and reliable device for use in a wide variety of applications.

A customized leadframe has been incorporated into the standard SOT-23 package to produce a HEXFET Power MOSFET with the industry's smallest footprint. This package, dubbed the Micro3, is ideal for applications where printed circuit board space is at a premium. The low profile (<1.1mm) of the Micro3 allows it to fit easily into extremely thin application environments such as portable electronics and PCMCIA cards.

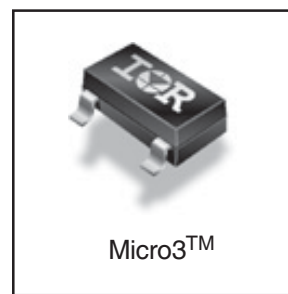

| Base Part Number | Package Type | Standard Pack | | Orderable Part Number |
|------------------|------------------|---------------|----------|-----------------------|
| | | Form | Quantity | |
| IRLML6302TRPbF | Micro3™ (SOT-23) | Tape and Reel | 3000 | IRLML6302TRPbF |

Absolute Maximum Ratings

| | Parameter | Max. | Units |
|--------------------------|--|-------------|-------|
| $I_D @ T_A = 25^\circ C$ | Continuous Drain Current, $V_{GS} @ -4.5V$ | -0.78 | A |
| $I_D @ T_A = 70^\circ C$ | Continuous Drain Current, $V_{GS} @ -4.5V$ | -0.62 | |
| I_{DM} | Pulsed Drain Current ① | -4.9 | |
| $P_D @ T_A = 25^\circ C$ | Power Dissipation | 540 | mW |
| | Linear Derating Factor | 4.3 | mW/°C |
| V_{GS} | Gate-to-Source Voltage | ± 12 | V |
| dv/dt | Peak Diode Recovery dv/dt ② | -5.0 | V/ns |
| T_J, T_{STG} | Junction and Storage Temperature Range | -55 to +150 | °C |

Thermal Resistance

| | Parameter | Typ. | Max. | Units |
|-----------------|-------------------------------|------|------|-------|
| $R_{\theta JA}$ | Maximum Junction-to-Ambient ④ | — | 230 | °C/W |

Electrical Characteristics @ T_J = 25°C (unless otherwise specified)

| | Parameter | Min. | Typ. | Max. | Units | Conditions |
|--|--------------------------------------|-------|------|------|-------------------------------------|--|
| V _{(BR)DSS} | Drain-to-Source Breakdown Voltage | -20 | — | — | V | V _{GS} = 0V, I _D = -250μA |
| ΔV _{(BR)DSS} /ΔT _J | Breakdown Voltage Temp. Coefficient | — | -4.9 | — | mV/°C | Reference to 25°C, I _D = -1mA |
| R _{DS(ON)} | Static Drain-to-Source On-Resistance | — | — | 0.60 | Ω | V _{GS} = -4.5V, I _D = -0.61A ③ |
| | | — | — | 0.90 | | V _{GS} = -2.7V, I _D = -0.31A ③ |
| V _{GS(th)} | Gate Threshold Voltage | -0.70 | — | -1.5 | V | V _{DS} = V _{GS} , I _D = -250μA |
| g _{fs} | Forward Transconductance | 0.56 | — | — | S | V _{DS} = -10V, I _D = -0.31A |
| I _{DSS} | Drain-to-Source Leakage Current | — | — | -1.0 | μA | V _{DS} = -16V, V _{GS} = 0V |
| | | — | — | -25 | | V _{DS} = -16V, V _{GS} = 0V, T _J = 125°C |
| I _{GSS} | Gate-to-Source Forward Leakage | — | — | -100 | nA | V _{GS} = -12V |
| | Gate-to-Source Reverse Leakage | — | — | 100 | | V _{GS} = 12V |
| Q _g | Total Gate Charge | — | 2.4 | 3.6 | nC | I _D = -0.61A |
| Q _{gs} | Gate-to-Source Charge | — | 0.56 | 0.84 | | V _{DS} = -16V |
| Q _{gd} | Gate-to-Drain ("Miller") Charge | — | 1.0 | 1.5 | | V _{GS} = -4.5V, See Fig. 6 and 9 ③ |
| t _{d(on)} | Turn-On Delay Time | — | 13 | — | | ns |
| t _r | Rise Time | — | 18 | — | I _D = -0.61A | |
| t _{d(off)} | Turn-Off Delay Time | — | 22 | — | R _G = 6.2Ω | |
| t _f | Fall Time | — | 22 | — | R _D = 16Ω, See Fig. 10 ③ | |
| C _{iss} | Input Capacitance | — | 97 | — | pF | V _{GS} = 0V |
| C _{oss} | Output Capacitance | — | 53 | — | | V _{DS} = -15V |
| C _{rss} | Reverse Transfer Capacitance | — | 28 | — | | f = 1.0MHz, See Fig. 5 |

Source-Drain Ratings and Characteristics

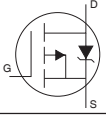
| | Parameter | Min. | Typ. | Max. | Units | Conditions |
|-----------------|---|------|------|-------|-------|--|
| I _S | Continuous Source Current (Body Diode) | — | — | -0.54 | A | MOSFET symbol showing the integral reverse p-n junction diode.  |
| I _{SM} | Pulsed Source Current (Body Diode) ① | — | — | -4.9 | | |
| V _{SD} | Diode Forward Voltage | — | — | -1.2 | V | T _J = 25°C, I _S = -0.61A, V _{GS} = 0V ④ |
| t _{rr} | Reverse Recovery Time | — | 35 | 53 | ns | T _J = 25°C, I _F = -0.61A |
| Q _{rr} | Reverse Recovery Charge | — | 26 | 39 | nC | di/dt = -100A/μs ④ |

Notes:

- ① Repetitive rating; pulse width limited by max. junction temperature. (See fig. 11)
- ② I_{SD} ≤ -0.61A, di/dt ≤ 76A/μs, V_{DD} ≤ V_{(BR)DSS}, T_J ≤ 150°C
- ③ Pulse width ≤ 300μs; duty cycle ≤ 2%.
- ④ Surface mounted on FR-4 board, t ≤ 5sec.

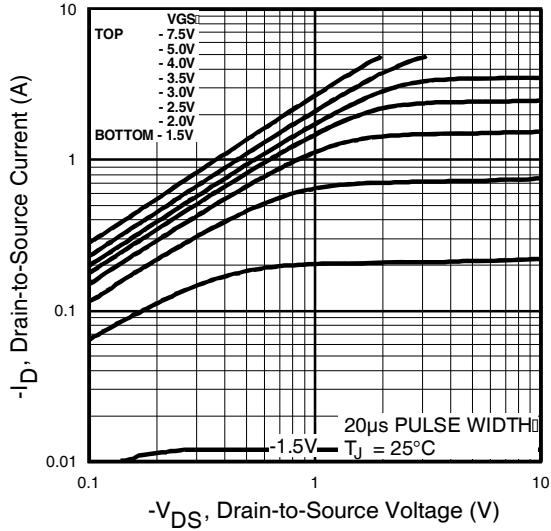
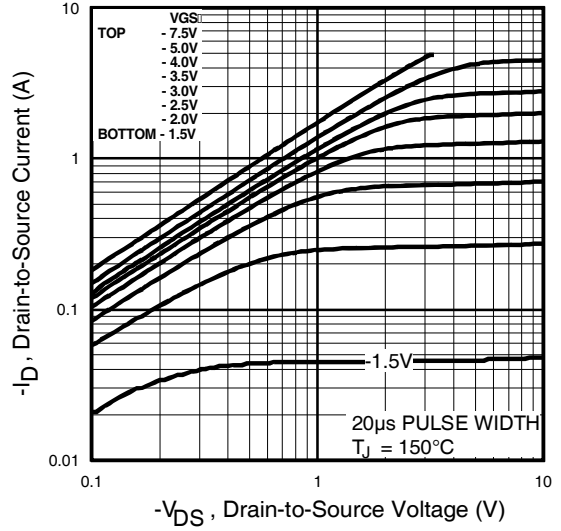
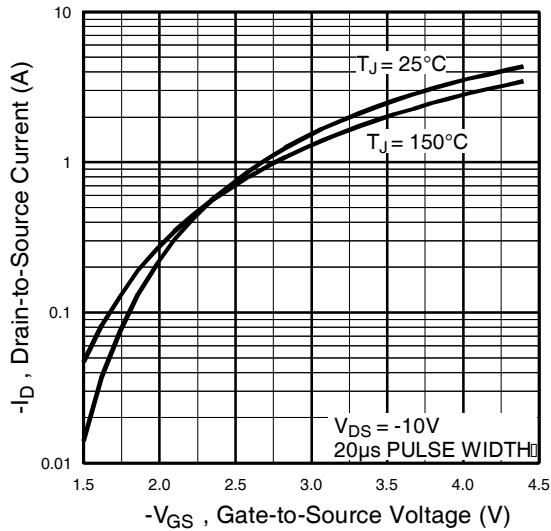
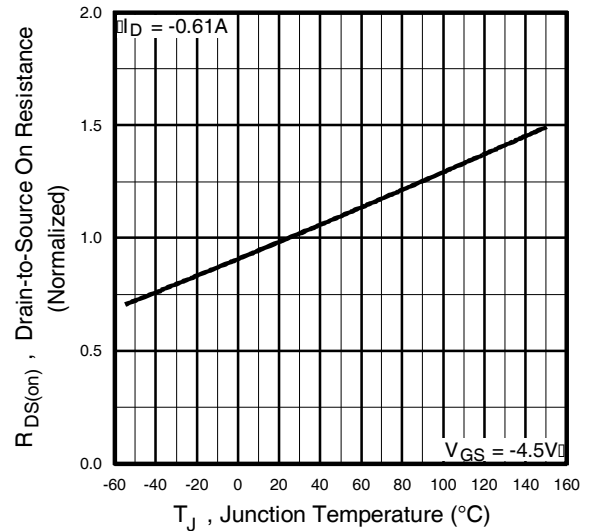
Fig 1. Typical Output Characteristics

Fig 2. Typical Output Characteristics

Fig 3. Typical Transfer Characteristics

Fig 4. Normalized On-Resistance Vs. Temperature

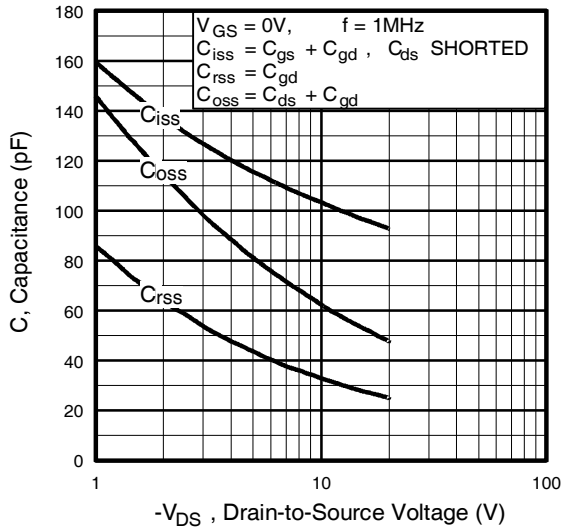

Fig 5. Typical Capacitance Vs. Drain-to-Source Voltage

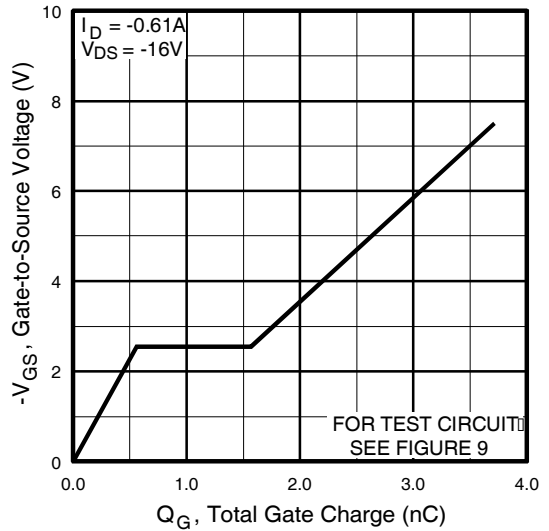

Fig 6. Typical Gate Charge Vs. Gate-to-Source Voltage

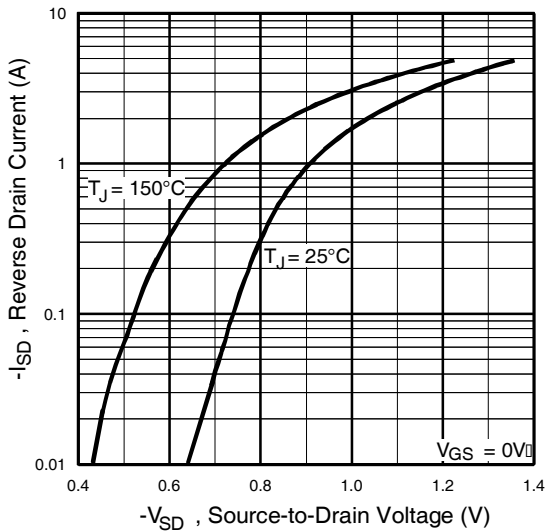

Fig 7. Typical Source-Drain Diode Forward Voltage

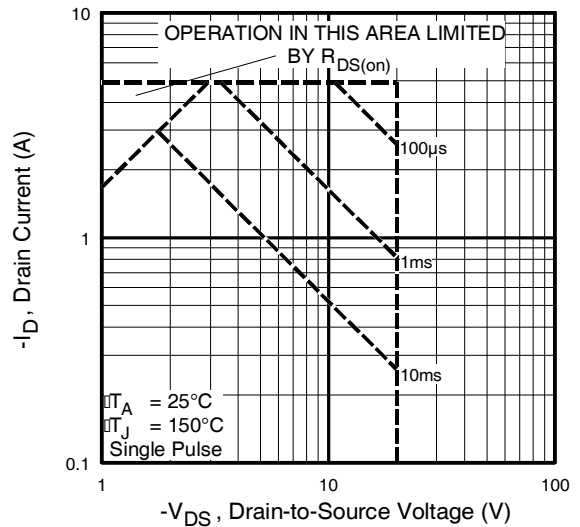
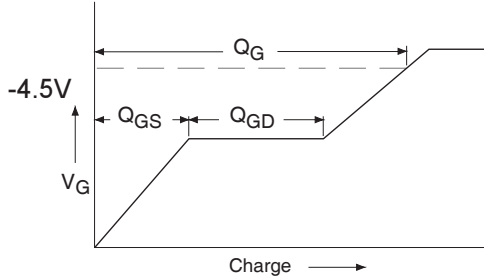
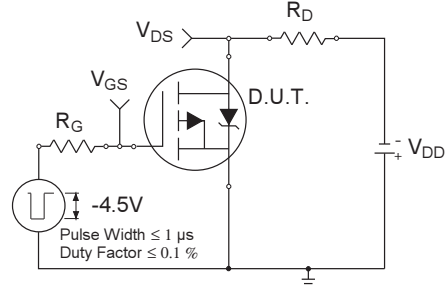
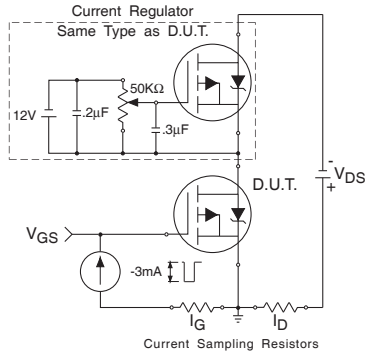
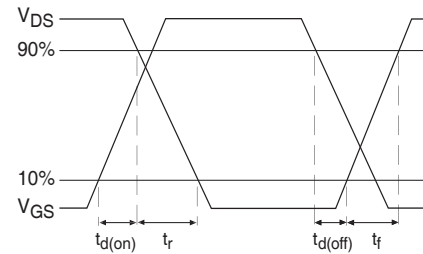
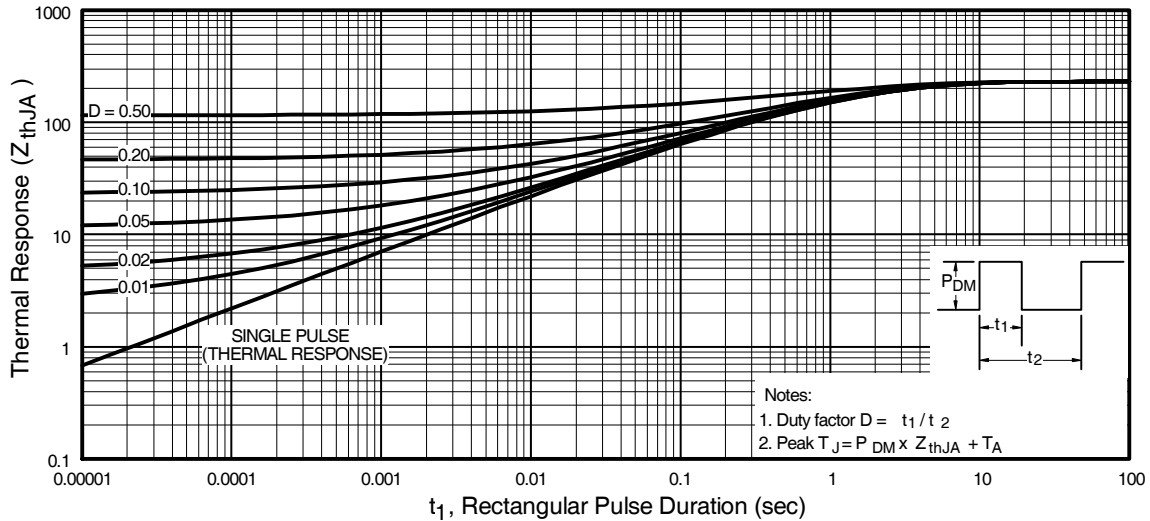
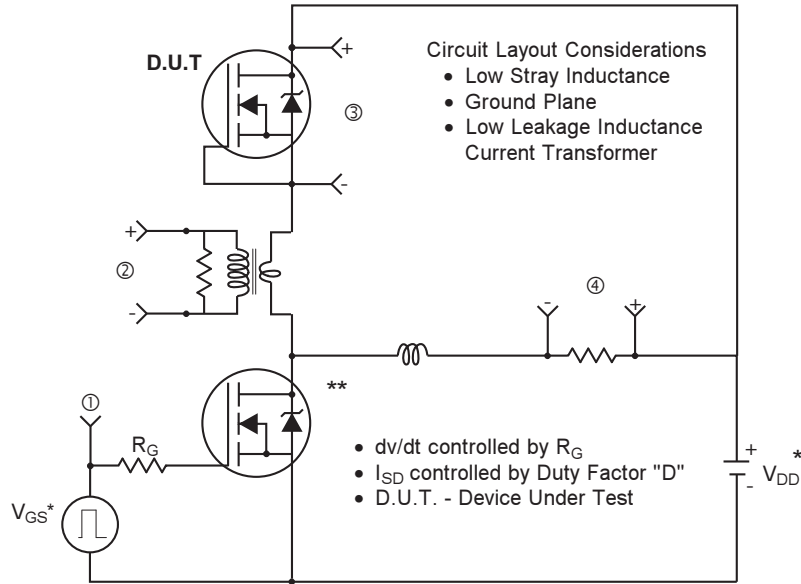

Fig 8. Maximum Safe Operating Area

Fig 9a. Basic Gate Charge Waveform

Fig 10a. Switching Time Test Circuit

Fig 9b. Gate Charge Test Circuit

Fig 10b. Switching Time Waveforms

Fig 11. Maximum Effective Transient Thermal Impedance, Junction-to-Ambient

Peak Diode Recovery dv/dt Test Circuit



* Reverse Polarity for P-Channel

** Use P-Channel Driver for P-Channel Measurements

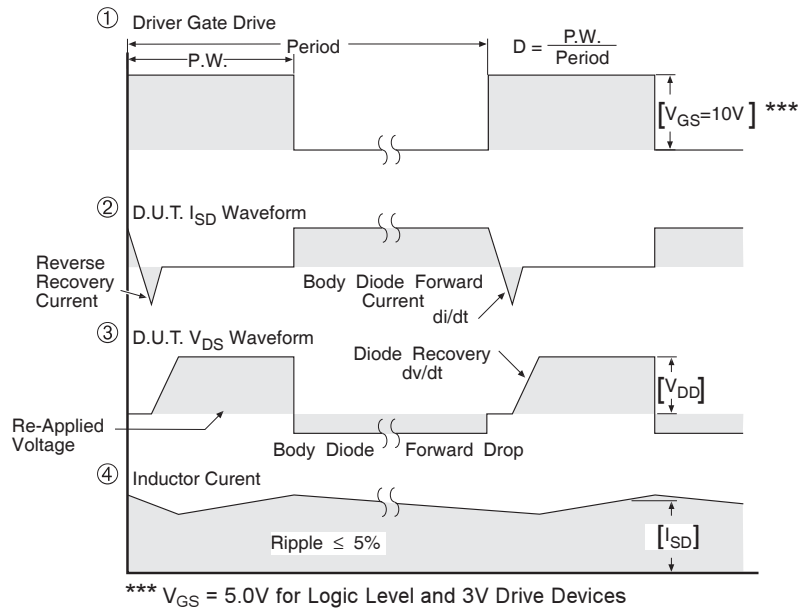
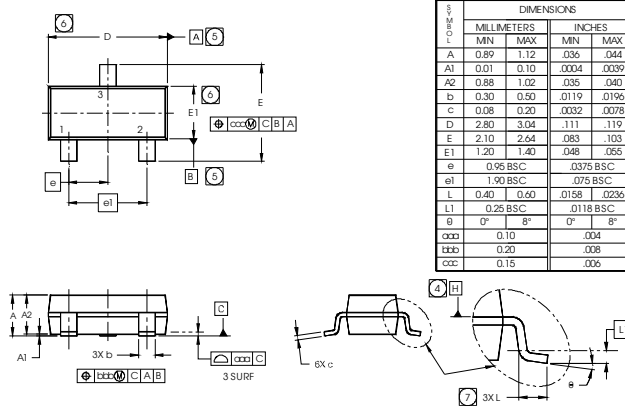

Fig 13. For P-Channel HEXFETS



Micro3 (SOT-23) (Lead-Free) Package Outline

Dimensions are shown in millimeters (inches)



| DIMENSIONS | DIMENSIONS | | | |
|------------|-------------|------|-----------|-------|
| | MILLIMETERS | | INCHES | |
| | MIN | MAX | MIN | MAX |
| A | 0.89 | 1.12 | .036 | .044 |
| A1 | 0.01 | 0.10 | .0004 | .0039 |
| A2 | 0.88 | 1.02 | .035 | .040 |
| b | 0.50 | 0.50 | .019 | .0196 |
| c | 0.08 | 0.20 | .0032 | .0078 |
| D | 2.80 | 3.04 | .111 | .119 |
| E | 2.10 | 2.64 | .083 | .103 |
| E1 | 1.20 | 1.40 | .048 | .056 |
| e | 0.95 BSC | | .0375 BSC | |
| e1 | 1.90 BSC | | .075 BSC | |
| L | 0.40 | 0.60 | .0158 | .0236 |
| L1 | 0.25 BSC | | .0118 BSC | |
| g | 0" | 8" | 0" | 8" |
| ccc | 0.10 | | .004 | |
| ddd | 0.20 | | .008 | |
| ccc | 0.15 | | .006 | |

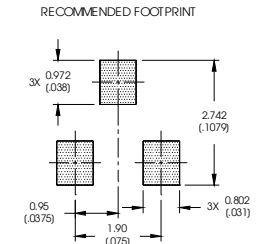

- NOTES
1. DIMENSIONING AND TOLERANCING PER ASME Y14.5M-1994.
 2. DIMENSIONS ARE SHOWN IN MILLIMETERS AND INCHES.
 3. CONTROLLING DIMENSION: MILLIMETER.
 4. DATUM PLANE H IS LOCATED AT THE MOLD PARTING LINE.
 5. DATUM A AND B TO BE DETERMINED AT DATUM PLANE H.
 6. DIMENSIONS D AND E1 ARE MEASURED AT DATUM PLANE H.
 7. DIMENSION L IS THE LEAD LENGTH FOR SOLDERING TO A SUBSTRATE.
 8. OUTLINE CONFORMS TO JEDEC OUTLINE TO-236AB.

Micro3 (SOT-23 / TO-236AB) Part Marking Information

Notes: This part marking information applies to devices produced after 02/26/2001

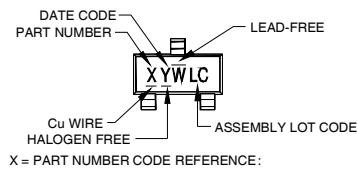

- X = PART NUMBER CODE REFERENCE:
- | | |
|---------------|---------------|
| A = IRLML2402 | S = IRLML6244 |
| B = IRLML2803 | T = IRLML6246 |
| C = IRLML6302 | U = IRLML6344 |
| D = IRLML5103 | V = IRLML6346 |
| E = IRLML6402 | W = IRFML8244 |
| F = IRLML6401 | X = IRLML2244 |
| G = IRLML2502 | Y = IRLML2246 |
| H = IRLML5203 | Z = IRFML9244 |
| I = IRLML0030 | |
| J = IRLML2030 | |
| K = IRLML0100 | |
| L = IRLML0060 | |
| M = IRLML0040 | |
| N = IRLML2060 | |
| P = IRLML9301 | |
| R = IRLML9303 | |

DATE CODE EXAMPLE:
 YWW = 432 = DF
 YWW = 503 = 5C

W = (1-26) IF PRECEDED BY LAST DIGIT OF CALENDAR YEAR

| YEAR | Y | WORK WEEK | W | |
|------|------|-----------|----|---|
| 2011 | 2001 | 1 | 01 | A |
| 2012 | 2002 | 2 | 02 | B |
| 2013 | 2003 | 3 | 03 | C |
| 2014 | 2004 | 4 | 04 | D |
| 2015 | 2005 | 5 | | |
| 2016 | 2006 | 6 | | |
| 2017 | 2007 | 7 | | |
| 2018 | 2008 | 8 | | |
| 2019 | 2009 | 9 | | |
| 2020 | 2010 | 0 | 24 | X |
| | | | 25 | Y |
| | | | 26 | Z |

W = (27-52) IF PRECEDED BY A LETTER

| YEAR | Y | WORK WEEK | W | |
|------|------|-----------|----|---|
| 2011 | 2001 | A | 27 | A |
| 2012 | 2002 | B | 28 | B |
| 2013 | 2003 | C | 29 | C |
| 2014 | 2004 | D | 30 | D |
| 2015 | 2005 | E | | |
| 2016 | 2006 | F | | |
| 2017 | 2007 | G | | |
| 2018 | 2008 | H | | |
| 2019 | 2009 | J | | |
| 2020 | 2010 | K | 50 | X |
| | | | 51 | Y |
| | | | 52 | Z |

Note: For the most current drawing please refer to IR website at <http://www.irf.com/package>

Micro3™ Tape & Reel Information

Dimensions are shown in millimeters (inches)

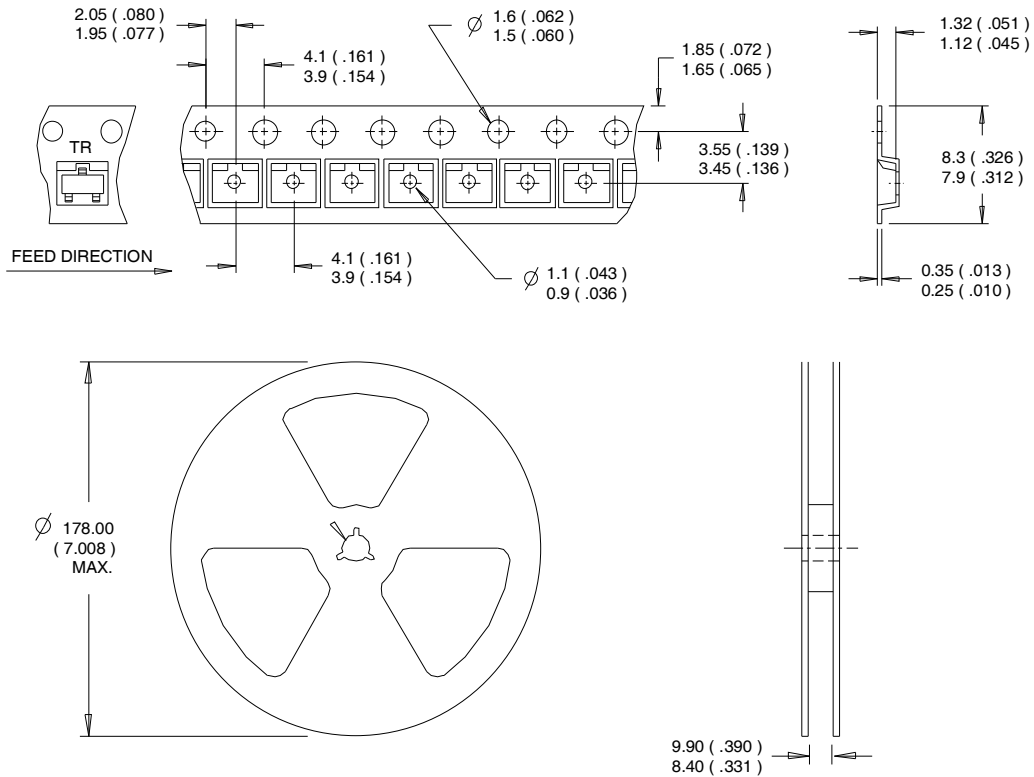

- NOTES:
 1. CONTROLLING DIMENSION : MILLIMETER.
 2. OUTLINE CONFORMS TO EIA-481 & EIA-541.

Note: For the most current drawing please refer to IR website at <http://www.irf.com/package>

Qualification information[†]

| | | |
|----------------------------|--|---|
| Qualification level | Consumer (per JEDEC JESD47F ^{††} guidelines) | |
| Moisture Sensitivity Level | Micro3™ (SOT-23) | MSL1 (per JEDEC J-STD-020D ^{††}) |
| RoHS compliant | Yes | |

[†] Qualification standards can be found at International Rectifier's web site: <http://www.irf.com/product-info/reliability>

^{††} Applicable version of JEDEC standard at the time of product release

Revision History

| Date | Comment |
|-----------|--|
| 4/28/2014 | <ul style="list-style-type: none"> • Updated data sheet with new IR corporate template. • Updated package outline & part marking on page 8. • Added Qualification table -Qual level "Consumer" on page 10. • Added bullet point in the Benefits "RoHS Compliant, Halogen -Free" on page 1. |

Mouser Electronics

Authorized Distributor

Click to View Pricing, Inventory, Delivery & Lifecycle Information:

[Infineon:](#)

[IRLML6302TRPBF](#)