



Is Now Part of



**ON Semiconductor®**

To learn more about ON Semiconductor, please visit our website at  
[www.onsemi.com](http://www.onsemi.com)

Please note: As part of the Fairchild Semiconductor integration, some of the Fairchild orderable part numbers will need to change in order to meet ON Semiconductor's system requirements. Since the ON Semiconductor product management systems do not have the ability to manage part nomenclature that utilizes an underscore (\_), the underscore (\_) in the Fairchild part numbers will be changed to a dash (-). This document may contain device numbers with an underscore (\_). Please check the ON Semiconductor website to verify the updated device numbers. The most current and up-to-date ordering information can be found at [www.onsemi.com](http://www.onsemi.com). Please email any questions regarding the system integration to [Fairchild\\_questions@onsemi.com](mailto:Fairchild_questions@onsemi.com).

ON Semiconductor and the ON Semiconductor logo are trademarks of Semiconductor Components Industries, LLC dba ON Semiconductor or its subsidiaries in the United States and/or other countries. ON Semiconductor owns the rights to a number of patents, trademarks, copyrights, trade secrets, and other intellectual property. A listing of ON Semiconductor's product/patent coverage may be accessed at [www.onsemi.com/site/pdf/Patent-Marking.pdf](http://www.onsemi.com/site/pdf/Patent-Marking.pdf). ON Semiconductor reserves the right to make changes without further notice to any products herein. ON Semiconductor makes no warranty, representation or guarantee regarding the suitability of its products for any particular purpose, nor does ON Semiconductor assume any liability arising out of the application or use of any product or circuit, and specifically disclaims any and all liability, including without limitation special, consequential or incidental damages. Buyer is responsible for its products and applications using ON Semiconductor products, including compliance with all laws, regulations and safety requirements or standards, regardless of any support or applications information provided by ON Semiconductor. "Typical" parameters which may be provided in ON Semiconductor data sheets and/or specifications can and do vary in different applications and actual performance may vary over time. All operating parameters, including "Typicals" must be validated for each customer application by customer's technical experts. ON Semiconductor does not convey any license under its patent rights nor the rights of others. ON Semiconductor products are not designed, intended, or authorized for use as a critical component in life support systems or any FDA Class 3 medical devices or medical devices with a same or similar classification in a foreign jurisdiction or any devices intended for implantation in the human body. Should Buyer purchase or use ON Semiconductor products for any such unintended or unauthorized application, Buyer shall indemnify and hold ON Semiconductor and its officers, employees, subsidiaries, affiliates, and distributors harmless against all claims, costs, damages, and expenses, and reasonable attorney fees arising out of, directly or indirectly, any claim of personal injury or death associated with such unintended or unauthorized use, even if such claim alleges that ON Semiconductor was negligent regarding the design or manufacture of the part. ON Semiconductor is an Equal Opportunity/Affirmative Action Employer. This literature is subject to all applicable copyright laws and is not for resale in any manner.

## MPSA14

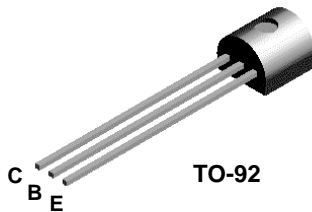

## MMBTA14

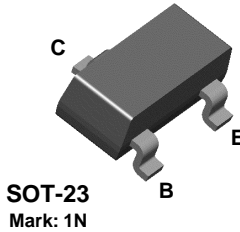

## PZTA14

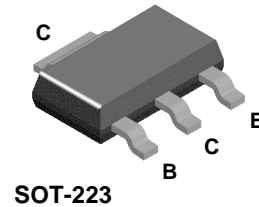

## NPN Darlington Transistor

This device is designed for applications requiring extremely high current gain at collector currents to 1.0 A. Sourced from Process 05.

### Absolute Maximum Ratings\*

TA = 25°C unless otherwise noted

Symbol	Parameter	Value	Units
$V_{CES}$	Collector-Emitter Voltage	30	V
$V_{CBO}$	Collector-Base Voltage	30	V
$V_{EBO}$	Emitter-Base Voltage	10	V
$I_C$	Collector Current - Continuous	1.2	A
$T_J, T_{stg}$	Operating and Storage Junction Temperature Range	-55 to +150	°C

\*These ratings are limiting values above which the serviceability of any semiconductor device may be impaired.

#### NOTES:

- 1) These ratings are based on a maximum junction temperature of 150 degrees C.
- 2) These are steady state limits. The factory should be consulted on applications involving pulsed or low duty cycle operations.

### Thermal Characteristics

TA = 25°C unless otherwise noted

Symbol	Characteristic	Max			Units
		MPSA14	*MMBTA14	**PZTA14	
$P_D$	Total Device Dissipation Derate above 25°C	625 5.0	350 2.8	1,000 8.0	mW mW/°C
$R_{\theta JC}$	Thermal Resistance, Junction to Case	83.3			°C/W
$R_{\theta JA}$	Thermal Resistance, Junction to Ambient	200	357	125	°C/W

\* Device mounted on FR-4 PCB 1.6" X 1.6" X 0.06."

\*\* Device mounted on FR-4 PCB 36 mm X 18 mm X 1.5 mm; mounting pad for the collector lead min. 6 cm<sup>2</sup>.

## NPN Darlington Transistor

(continued)

### Electrical Characteristics TA = 25°C unless otherwise noted

Symbol	Parameter	Test Conditions	Min	Max	Units
<b>OFF CHARACTERISTICS</b>					
$V_{(BR)CES}$	Collector-Emitter Breakdown Voltage	$I_C = 100 \mu A, I_B = 0$	30		V
$I_{CBO}$	Collector-Cutoff Current	$V_{CB} = 30 V, I_E = 0$		100	nA
$I_{EBO}$	Emitter-Cutoff Current	$V_{EB} = 10 V, I_C = 0$		100	nA
<b>ON CHARACTERISTICS*</b>					
$h_{FE}$	DC Current Gain	$I_C = 10 mA, V_{CE} = 5.0 V$ $I_C = 100 mA, V_{CE} = 5.0 V$	10,000 20,000		
$V_{CE(sat)}$	Collector-Emitter Saturation Voltage	$I_C = 100 mA, I_B = 0.1 mA$		1.5	V
$V_{BE(on)}$	Base-Emitter On Voltage	$I_C = 100 mA, V_{CE} = 5.0 V$		2.0	V
<b>SMALL SIGNAL CHARACTERISTICS</b>					
$f_T$	Current Gain - Bandwidth Product	$I_C = 10 mA, V_{CE} = 5 V,$ $f = 100 MHz$	125		MHz

\*Pulse Test: Pulse Width  $\leq 300 \mu s$ , Duty Cycle  $\leq 2.0\%$

### Typical Characteristics

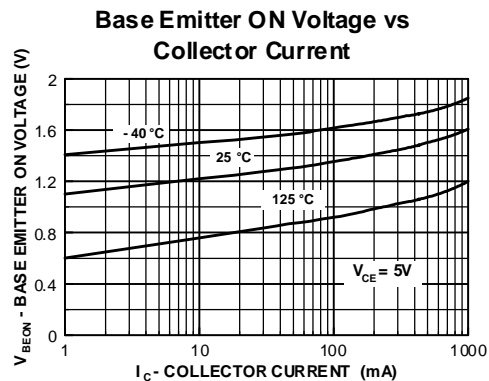
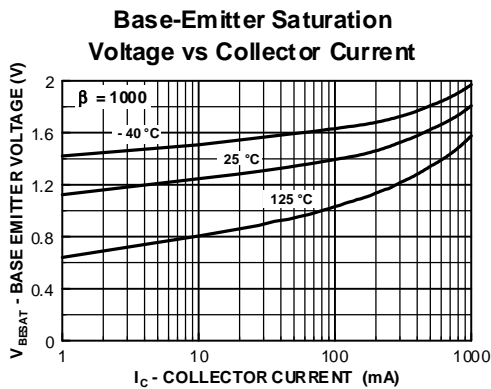
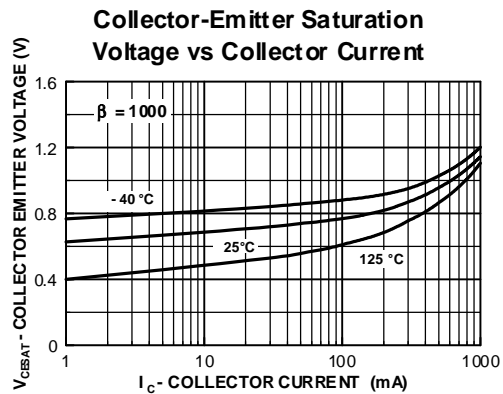
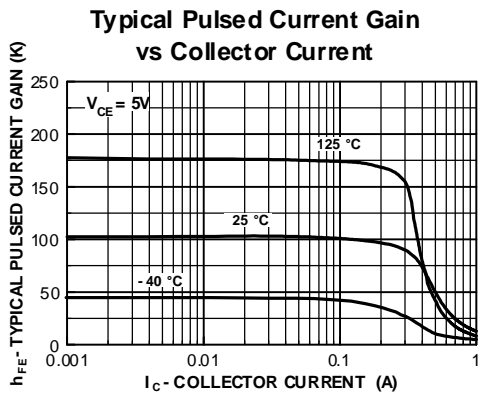

**NPN Darlington Transistor**  
(continued)

**Typical Characteristics** (continued)

**Collector-Cutoff Current vs Ambient Temperature**

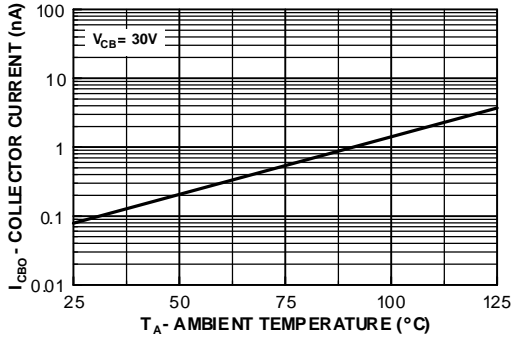

**Collector-Emitter Breakdown Voltage with Resistance Between Emitter-Base**

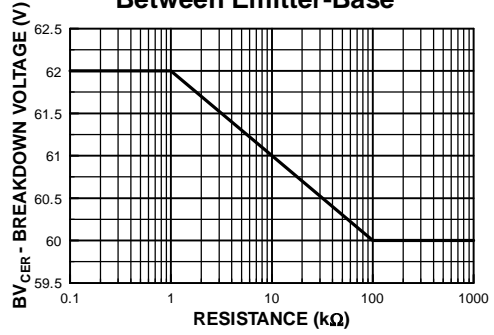

**Input and Output Capacitance vs Reverse Voltage**

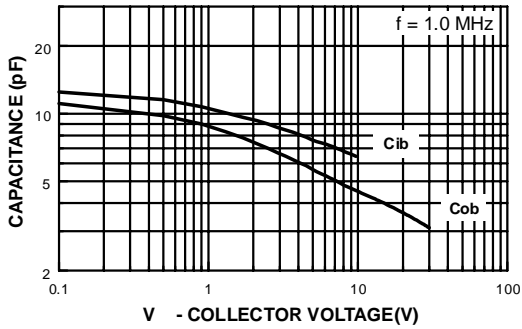

**Gain Bandwidth Product vs Collector Current**

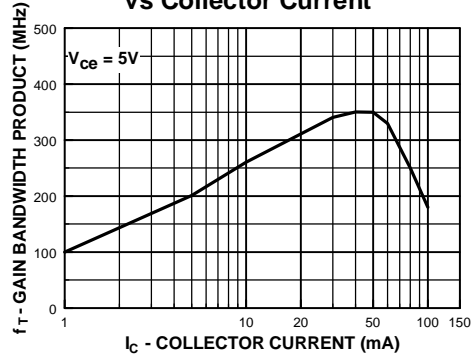

**Power Dissipation vs Ambient Temperature**

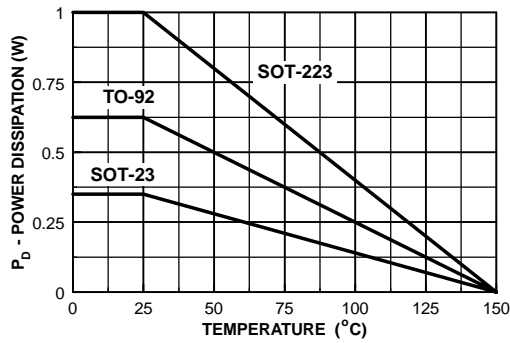

# TO-92 Tape and Reel Data



## TO-92 Packaging Configuration: Figure 1.0

FSCINT Label sample



F63TNR Label sample



### TO-92 TNR/AMMO PACKING INFORMATION

Packing	Style	Quantity	EOL code
Reel	A	2,000	D26Z
	E	2,000	D27Z
Ammo	M	2,000	D74Z
	P	2,000	D75Z

Unit weight = 0.22 gm  
 Reel weight with components = 1.04 kg  
 Ammo weight with components = 1.02 kg  
 Max quantity per intermediate box = 10,000 units



### (TO-92) BULK PACKING INFORMATION

EOL CODE	DESCRIPTION	LEADCLIP DIMENSION	QUANTITY
J18Z	TO-18 OPTION STD	NO LEAD CLIP	2.0 K / BOX
J05Z	TO-5 OPTION STD	NO LEAD CLIP	1.5 K / BOX
NO EOL CODE	TO-92 STANDARD STRAIGHT FOR: PKG 92, 94 (NON PROELECTRON SERIES), 96	NO LEADCLIP	2.0 K / BOX
L34Z	TO-92 STANDARD STRAIGHT FOR: PKG 94 (PROELECTRON SERIES BCXXX, BFXXX, BSRXXX), 97, 98	NO LEADCLIP	2.0 K / BOX

### BULK OPTION

See Bulk Packing Information table



## TO-92 Tape and Reel Data, continued

### TO-92 Reeling Style

Configuration: Figure 2.0

#### Machine Option "A" (H)



Style "A", D26Z, D70Z (s/h)

#### Machine Option "E" (J)



Style "E", D27Z, D71Z (s/h)

### TO-92 Radial Ammo Packaging

Configuration: Figure 3.0

FIRST WIRE OFF IS COLLECTOR  
ADHESIVE TAPE IS ON THE TOP SIDE  
FLAT OF TRANSISTOR IS ON TOP



ORDER STYLE  
D74Z (M)

FIRST WIRE OFF IS EMITTER (ON PKG. 92)  
ADHESIVE TAPE IS ON BOTTOM SIDE  
FLAT OF TRANSISTOR IS ON BOTTOM

FIRST WIRE OFF IS EMITTER  
ADHESIVE TAPE IS ON THE TOP SIDE  
FLAT OF TRANSISTOR IS ON BOTTOM



ORDER STYLE  
D75Z (P)

FIRST WIRE OFF IS COLLECTOR (ON PKG. 92)  
ADHESIVE TAPE IS ON BOTTOM SIDE  
FLAT OF TRANSISTOR IS ON TOP

# TO-92 Tape and Reel Data, continued

**TO-92 Tape and Reel Taping  
Dimension Configuration: Figure 4.0**

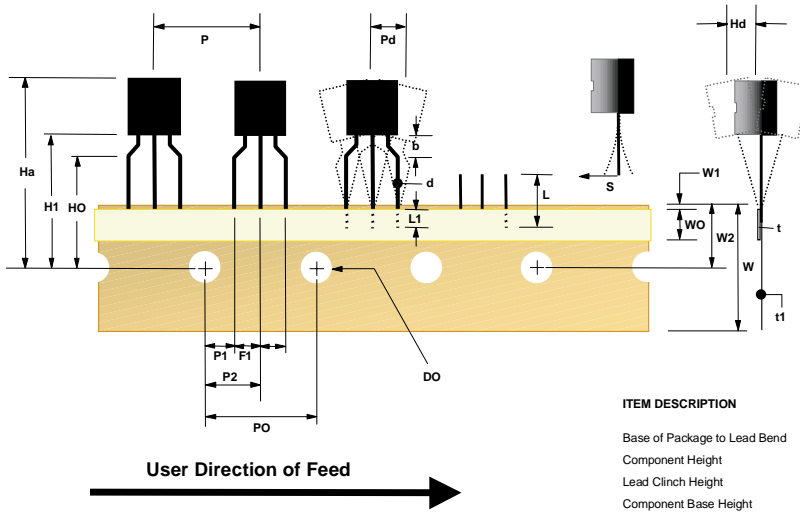

ITEM DESCRIPTION	SYMBOL	DIMENSION
Base of Package to Lead Bend	b	0.098 (max)
Component Height	Ha	0.928 (+/- 0.025)
Lead Clinch Height	HO	0.630 (+/- 0.020)
Component Base Height	H1	0.748 (+/- 0.020)
Component Alignment ( side/side )	Pd	0.040 (max)
Component Alignment ( front/back )	Hd	0.031 (max)
Component Pitch	P	0.500 (+/- 0.020)
Feed Hole Pitch	PO	0.500 (+/- 0.008)
Hole Center to First Lead	P1	0.150 (+0.009, -0.010)
Hole Center to Component Center	P2	0.247 (+/- 0.007)
Lead Spread	F1/F2	0.104 (+/- 0.010)
Lead Thickness	d	0.018 (+0.002, -0.003)
Cut Lead Length	L	0.429 (max)
Taped Lead Length	L1	0.209 (+0.051, -0.052)
Taped Lead Thickness	t	0.032 (+/- 0.006)
Carrier Tape Thickness	t1	0.021 (+/- 0.006)
Carrier Tape Width	W	0.708 (+0.020, -0.019)
Hold - down Tape Width	WO	0.236 (+/- 0.012)
Hold - down Tape position	W1	0.035 (max)
Feed Hole Position	W2	0.360 (+/- 0.025)
Sprocket Hole Diameter	DO	0.157 (+0.008, -0.007)
Lead Spring Out	S	0.004 (max)

Note : All dimensions are in inches.

**TO-92 Reel  
Configuration: Figure 5.0**

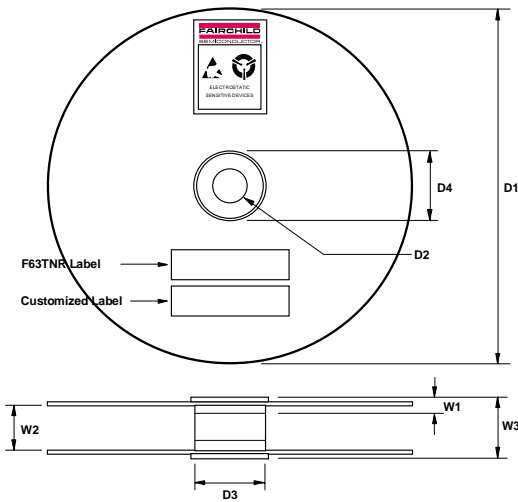

ITEM DESCRIPTION	SYMBOL	MINIMUM	MAXIMUM
Reel Diameter	D1	13.975	14.025
Arbor Hole Diameter (Standard)	D2	1.160	1.200
(Small Hole)	D2	0.650	0.700
Core Diameter	D3	3.100	3.300
Hub Recess Inner Diameter	D4	2.700	3.100
Hub Recess Depth	W1	0.370	0.570
Flange to Flange Inner Width	W2	1.630	1.690
Hub to Hub Center Width	W3		2.090

Note: All dimensions are in inches

# TO-92 Package Dimensions



## TO-92 (FS PKG Code 92, 94, 96)

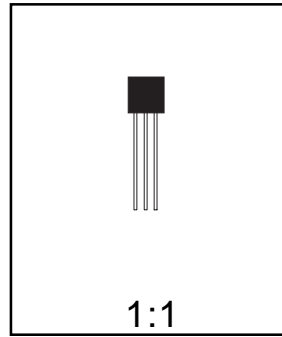

Scale 1:1 on letter size paper

Dimensions shown below are in:  
inches [millimeters]

Part Weight per unit (gram): 0.1977

TO-92 (92,94,96)

PIN	92		94		96	
	B	F	B	F	B	F
1	E	D	E	D	B	S
2	B	S	C	G	E	D
3	C	G	B	S	C	G





# SOT-23 Tape and Reel Data



## SOT-23 Packaging Configuration: Figure 10

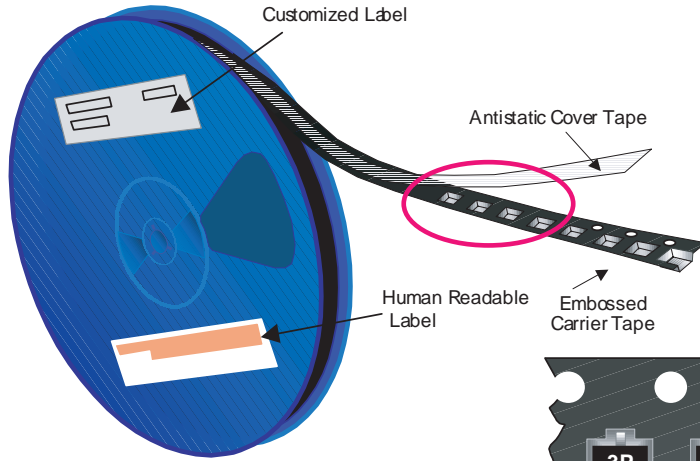

### Packaging Description:

SOT-23 parts are shipped in tape. The carrier tape is made from a dissipative (carbon filled) polycarbonate resin. The cover tape is a multilayer film (Heat Activated Adhesive in nature) primarily composed of polyester film, adhesive layer, sealant, and anti-static sprayed agent. These reeled parts in standard option are shipped with 3,000 units per 7" or 177mm diameter reel. The reels are dark blue in color and is made of polystyrene plastic (anti-static coated). Other option comes in 10,000 units per 13" or 330mm diameter reel. This and some other options are described in the Packaging Information table.

These full reels are individually labeled and placed inside a standard intermediate made of recyclable corrugated brown paper with a Fairchild logo printing. One pizza box contains eight reels maximum. And these intermediate boxes are placed inside a labeled shipping box which comes in different sizes depending on the number of parts shipped.

SOT-23 Packaging Information		
Packaging Option	Standard (no flow code)	D87Z
Packaging type	TNR	TNR
Qty per Reel/Tube/Bag	3,000	10,000
Reel Size	7" Dia	13"
Box Dimension (mm)	187x107x183	343x343x64
Max qty per Box	24,000	30,000
Weight per unit (gm)	0.0082	0.0082
Weight per Reel (kg)	0.1175	0.4006
Note/Comments		

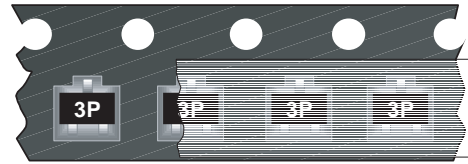

### SOT-23 Unit Orientation

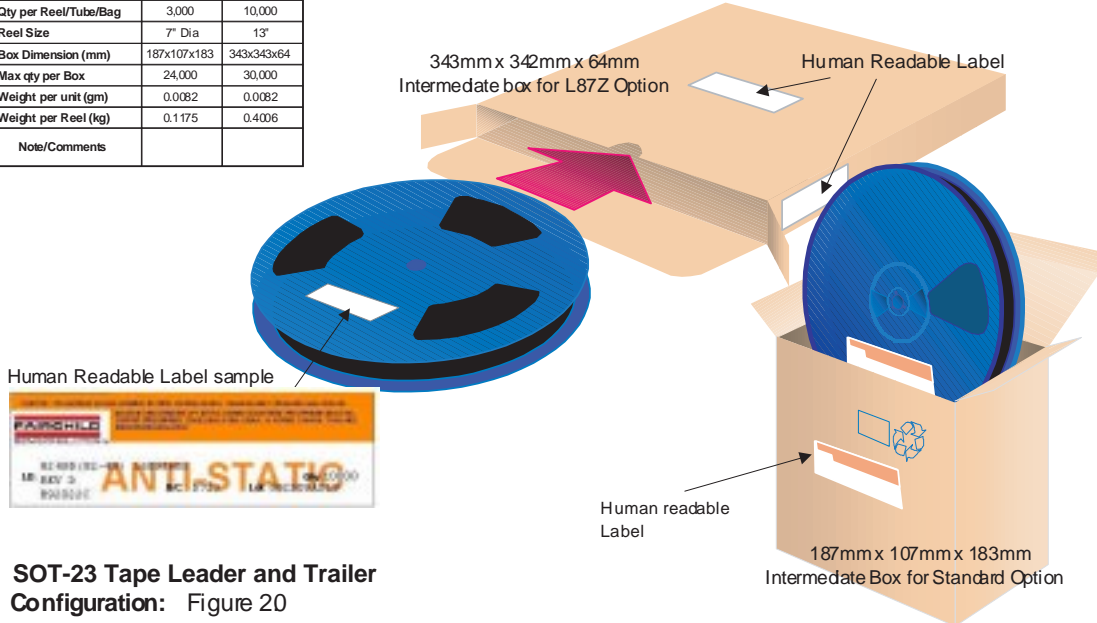

Human Readable Label sample



## SOT-23 Tape Leader and Trailer Configuration: Figure 20

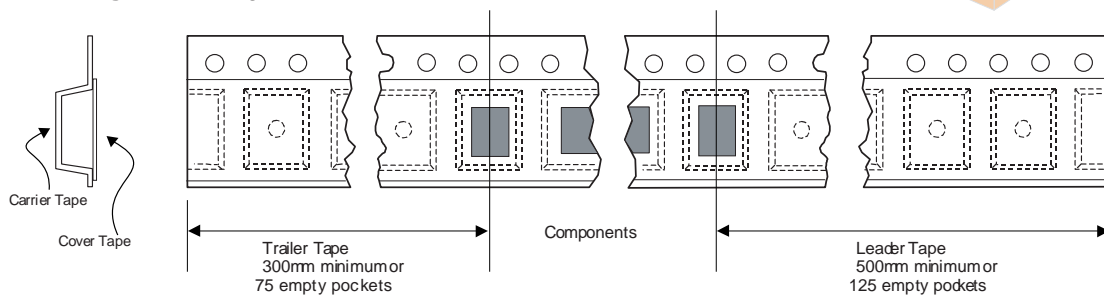

# SOT-23 Tape and Reel Data, continued

## SOT-23 Embossed Carrier Tape Configuration: Figure 3.0



Dimensions are in millimeter

Pkg type	A0	B0	W	D0	D1	E1	E2	F	P1	P0	K0	T	Wc	Tc
SOT-23 (8mm)	3.15 ±0.10	2.77 ±0.10	8.0 ±0.3	1.55 ±0.05	1.125 ±0.125	1.75 ±0.10	6.25 min	3.50 ±0.05	4.0 ±0.1	4.0 ±0.1	1.30 ±0.10	0.228 ±0.013	5.2 ±0.3	0.06 ±0.02

Notes: A0, B0, and K0 dimensions are determined with respect to the EIA/Jedec RS-481 rotational and lateral movement requirements (see sketches A, B, and C).



Sketch A (Side or Front Sectional View)  
Component Rotation

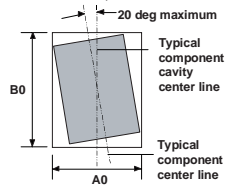

Sketch B (Top View)  
Component Rotation



Sketch C (Top View)  
Component lateral movement

## SOT-23 Reel Configuration: Figure 4.0

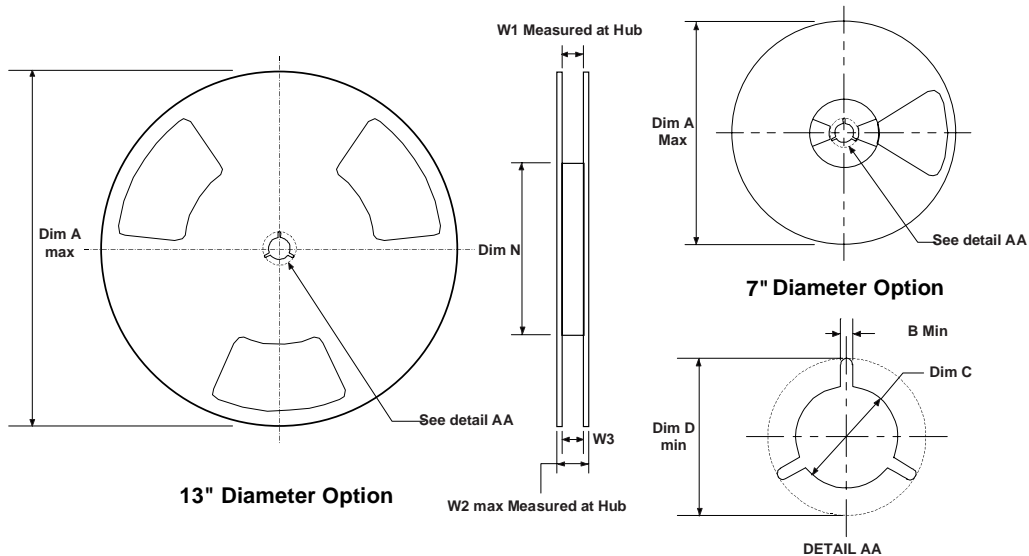

Dimensions are in inches and millimeters

Tape Size	Reel Option	Dim A	Dim B	Dim C	Dim D	Dim N	Dim W1	Dim W2	Dim W3 (LSL-USL)
8mm	7" Dia	7.00 177.8	0.059 1.5	512 +0.020/-0.008 13 +0.5/-0.2	0.795 20.2	2.165 55	0.331 +0.059/-0.000 8.4 +1.5/0	0.567 14.4	0.311 -0.429 7.9 - 10.9
8mm	13" Dia	13.00 330	0.059 1.5	512 +0.020/-0.008 13 +0.5/-0.2	0.795 20.2	4.00 100	0.331 +0.059/-0.000 8.4 +1.5/0	0.567 14.4	0.311 -0.429 7.9 - 10.9

# SOT-23 Package Dimensions



## SOT-23 (FS PKG Code 49)

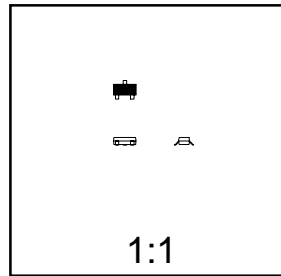

Scale 1:1 on letter size paper

Dimensions shown below are in:  
inches [millimeters]

Part Weight per unit (gram): 0.0082

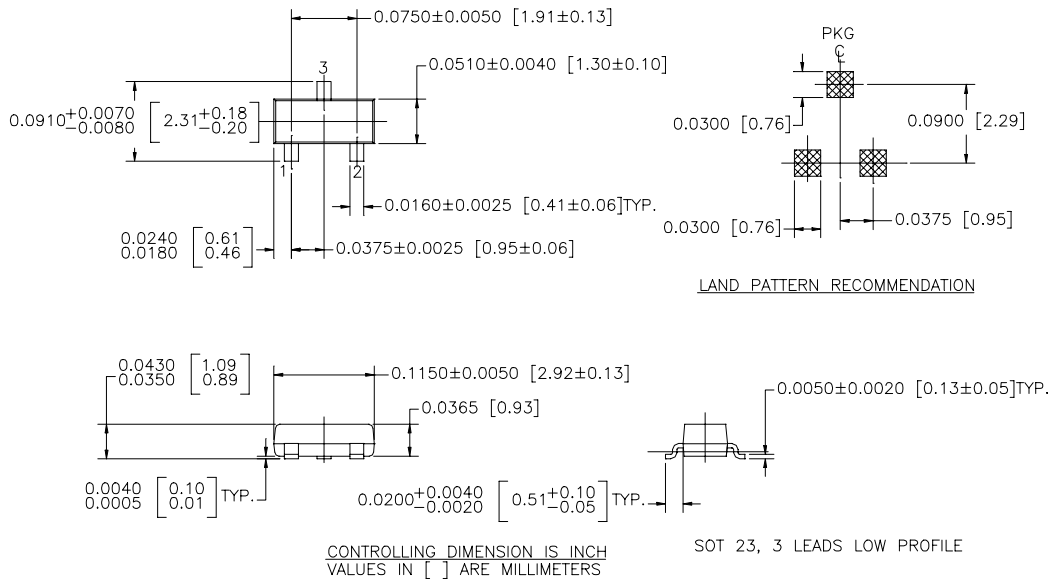

NOTE : UNLESS OTHERWISE SPECIFIED

- STANDARD LEAD FINISH 150 MICRONS / 3.81 MICROMETERS  
MINIMUM TIN / LEAD (SOLDER) ON ALLOY 42
- REFERENCE JEDEC REGISTRATION TO-236, VARIATION AB, ISSUE G, DATED JUL 1993

# SOT-223 Tape and Reel Data



## SOT-223 Packaging Configuration: Figure 1.0

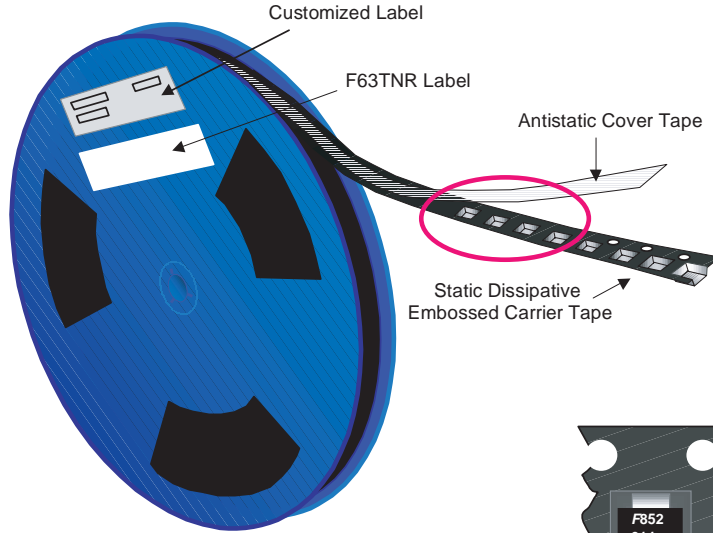

**Packaging Description:**  
 SOT-223 parts are shipped in tape. The carrier tape is made from a dissipative (carbon filled) polycarbonate resin. The cover tape is a multilayer film (Heat Activated Adhesive in nature) primarily composed of polyester film, adhesive layer, sealant, and anti-static sprayed agent. These reeled parts in standard option are shipped with 2,500 units per 13" or 330cm diameter reel. The reels are dark blue in color and is made of polystyrene plastic (anti-static coated). Other option comes in 500 units per 7" or 177cm diameter reel. This and some other options are further described in the Packaging Information table.  
 These full reels are individually barcode labeled and placed inside a standard intermediate box (illustrated in figure 1.0) made of recyclable corrugated brown paper. One box contains two reels maximum. And these boxes are placed inside a barcode labeled shipping box which comes in different sizes depending on the number of parts shipped.

SOT-223 Packaging Information		
Packaging Option	Standard (no flow code)	D84Z
Packaging type	TNR	TNR
Qty per Reel/Tube/Bag	2,500	500
Reel Size	13" Dia	7" Dia
Box Dimension (mm)	343x64x343	184x187x47
Max qty per Box	5,000	1,000
Weight per unit (gm)	0.1246	0.1246
Weight per Reel (kg)	0.7250	0.1532
Note/Comments		

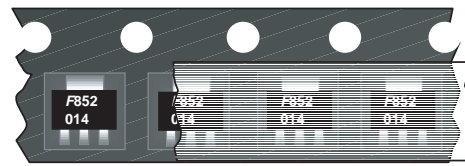

### SOT-223 Unit Orientation

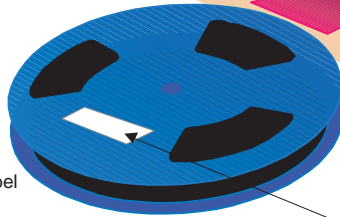
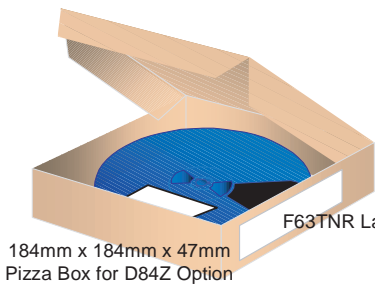
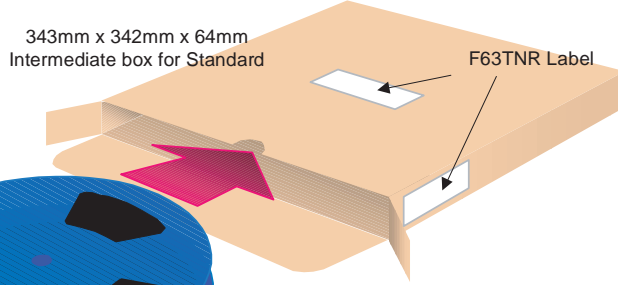

**F63TNR Label sample**

LOT: CBVK741B019	QTY: 3000
FSID: PN2222A	SPEC:
D/C1: D984Z	QTY1:
D/C2:	QTY2:
SPEC REV: CPN:	N/F: F
(F63TNR)3	

## SOT-223 Tape Leader and Trailer Configuration: Figure 2.0

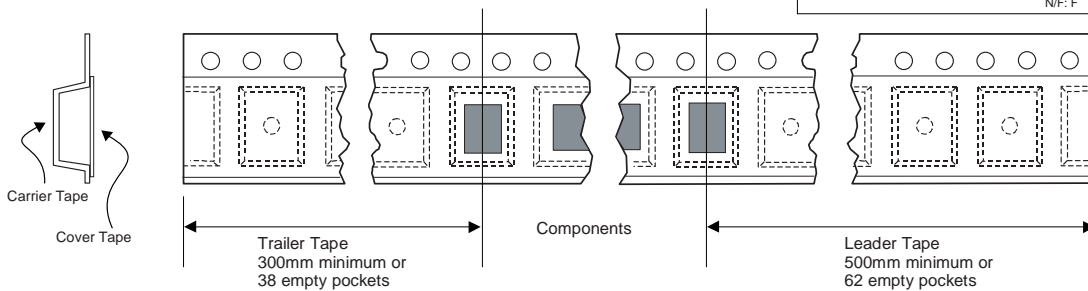

# SOT-223 Tape and Reel Data, continued

## SOT-223 Embossed Carrier Tape Configuration: Figure 3.0

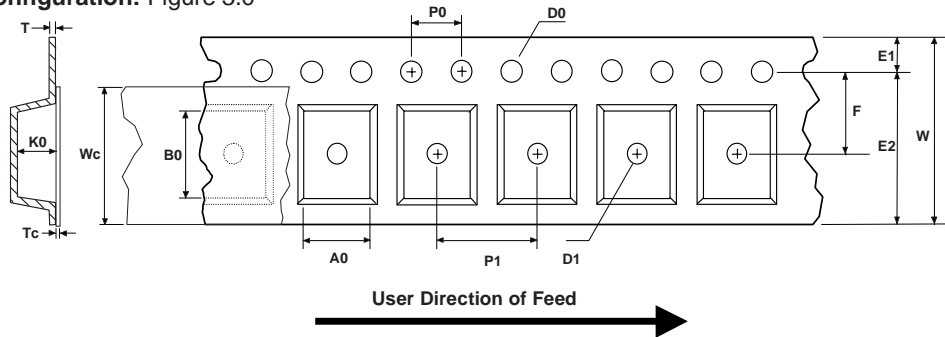

Dimensions are in millimeter														
Pkg type	A0	B0	W	D0	D1	E1	E2	F	P1	P0	K0	T	Wc	Tc
SOT-223 (12mm)	6.83 +/-0.10	7.42 +/-0.10	12.0 +/-0.3	1.55 +/-0.05	1.50 +/-0.10	1.75 +/-0.10	10.25 min	5.50 +/-0.05	8.0 +/-0.1	4.0 +/-0.1	1.88 +/-0.10	0.292 +/- 0.0130	9.5 +/-0.025	0.06 +/-0.02

Notes: A0, B0, and K0 dimensions are determined with respect to the EIA/Jedec RS-481 rotational and lateral movement requirements (see sketches A, B, and C).

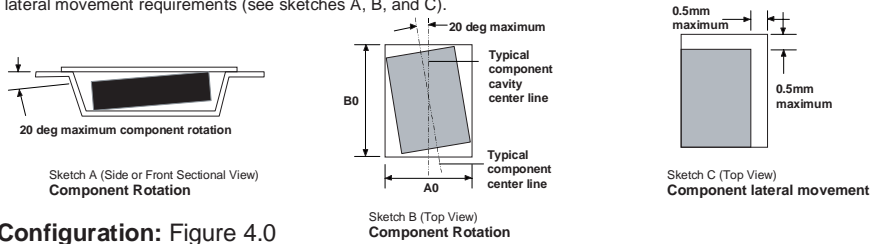

## SOT-223 Reel Configuration: Figure 4.0

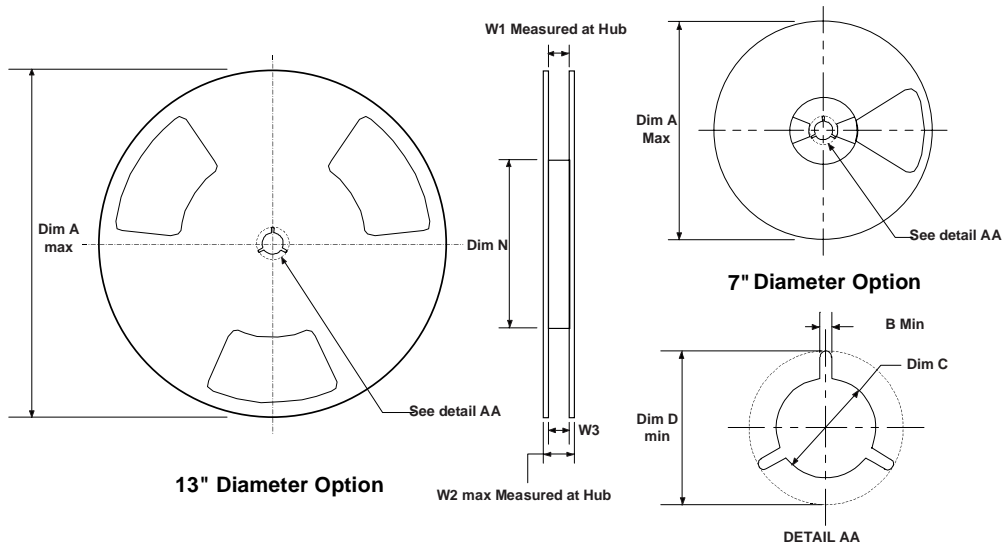

Dimensions are in inches and millimeters									
Tape Size	Reel Option	Dim A	Dim B	Dim C	Dim D	Dim N	Dim W1	Dim W2	Dim W3 (LSL-USL)
12mm	7" Dia	7.00 177.8	0.059 1.5	512 +0.020/-0.008 13 +0.5/-0.2	0.795 20.2	5.906 150	0.488 +0.078/-0.000 12.4 +2/0	0.724 18.4	0.469 - 0.606 11.9 - 15.4
12mm	13" Dia	13.00 330	0.059 1.5	512 +0.020/-0.008 13 +0.5/-0.2	0.795 20.2	7.00 178	0.488 +0.078/-0.000 12.4 +2/0	0.724 18.4	0.469 - 0.606 11.9 - 15.4

# SOT-223 Package Dimensions



## SOT-223 (FS PKG Code 47)

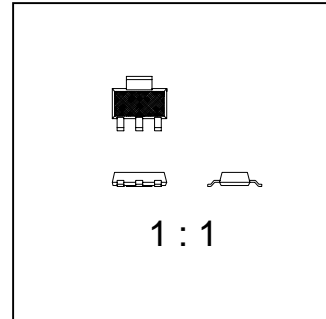
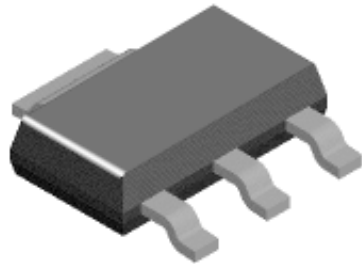

Scale 1:1 on letter size paper

Part Weight per unit (gram): 0.1246

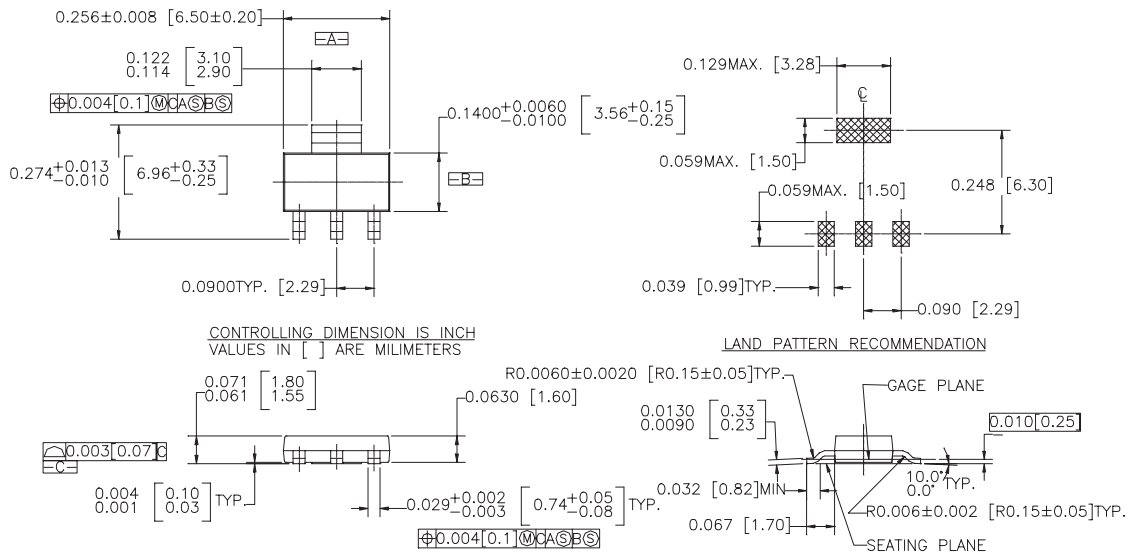

- NOTES : UNLESS OTHERWISE SPECIFIED
- STANDARD LEAD FINISH TO BE 150 MICRONS/ 3.81 MICROMETERS MINIMUM TIN/LEAD (SOLDER) ON COPPER.
  - REFERENCE JEDEC REGISTRATION TO-261, VARIATION AA, ISSUE A, DATED JAN 1990

## TRADEMARKS

The following are registered and unregistered trademarks Fairchild Semiconductor owns or is authorized to use and is not intended to be an exhaustive list of all such trademarks.

ACE <sup>x</sup> <sup>TM</sup>	FAST <sup>r</sup> <sup>TM</sup>	PowerTrench <sup>®</sup>	SyncFET <sup>TM</sup>
Bottomless <sup>TM</sup>	GlobalOptoisolator <sup>TM</sup>	QFET <sup>TM</sup>	TinyLogic <sup>TM</sup>
CoolFET <sup>TM</sup>	GTO <sup>TM</sup>	QS <sup>TM</sup>	UHC <sup>TM</sup>
CROSSVOLT <sup>TM</sup>	HiSeC <sup>TM</sup>	QT Optoelectronics <sup>TM</sup>	VCX <sup>TM</sup>
DO <sup>ME</sup> <sup>TM</sup>	ISOP <sup>LANAR</sup> <sup>TM</sup>	Quiet Series <sup>TM</sup>	
E <sup>2</sup> CMOS <sup>TM</sup>	MICROWIRE <sup>TM</sup>	SILENT SWITCHER <sup>®</sup>	
EnSigna <sup>TM</sup>	OPTOLOGIC <sup>TM</sup>	SMART START <sup>TM</sup>	
FACT <sup>TM</sup>	OPTOPLANAR <sup>TM</sup>	SuperSOT <sup>TM</sup> -3	
FACT Quiet Series <sup>TM</sup>	PACMAN <sup>TM</sup>	SuperSOT <sup>TM</sup> -6	
FAST <sup>®</sup>	POP <sup>TM</sup>	SuperSOT <sup>TM</sup> -8	

## DISCLAIMER

FAIRCHILD SEMICONDUCTOR RESERVES THE RIGHT TO MAKE CHANGES WITHOUT FURTHER NOTICE TO ANY PRODUCTS HEREIN TO IMPROVE RELIABILITY, FUNCTION OR DESIGN. FAIRCHILD DOES NOT ASSUME ANY LIABILITY ARISING OUT OF THE APPLICATION OR USE OF ANY PRODUCT OR CIRCUIT DESCRIBED HEREIN; NEITHER DOES IT CONVEY ANY LICENSE UNDER ITS PATENT RIGHTS, NOR THE RIGHTS OF OTHERS.

## LIFE SUPPORT POLICY

FAIRCHILD'S PRODUCTS ARE NOT AUTHORIZED FOR USE AS CRITICAL COMPONENTS IN LIFE SUPPORT DEVICES OR SYSTEMS WITHOUT THE EXPRESS WRITTEN APPROVAL OF FAIRCHILD SEMICONDUCTOR CORPORATION. As used herein:

1. Life support devices or systems are devices or systems which, (a) are intended for surgical implant into the body, or (b) support or sustain life, or (c) whose failure to perform when properly used in accordance with instructions for use provided in the labeling, can be reasonably expected to result in significant injury to the user.
2. A critical component is any component of a life support device or system whose failure to perform can be reasonably expected to cause the failure of the life support device or system, or to affect its safety or effectiveness.

## PRODUCT STATUS DEFINITIONS

### Definition of Terms

Datasheet Identification	Product Status	Definition
Advance Information	Formative or In Design	This datasheet contains the design specifications for product development. Specifications may change in any manner without notice.
Preliminary	First Production	This datasheet contains preliminary data, and supplementary data will be published at a later date. Fairchild Semiconductor reserves the right to make changes at any time without notice in order to improve design.
No Identification Needed	Full Production	This datasheet contains final specifications. Fairchild Semiconductor reserves the right to make changes at any time without notice in order to improve design.
Obsolete	Not In Production	This datasheet contains specifications on a product that has been discontinued by Fairchild semiconductor. The datasheet is printed for reference information only.

ON Semiconductor and  are trademarks of Semiconductor Components Industries, LLC dba ON Semiconductor or its subsidiaries in the United States and/or other countries. ON Semiconductor owns the rights to a number of patents, trademarks, copyrights, trade secrets, and other intellectual property. A listing of ON Semiconductor's product/patent coverage may be accessed at [www.onsemi.com/site/pdf/Patent-Marking.pdf](http://www.onsemi.com/site/pdf/Patent-Marking.pdf). ON Semiconductor reserves the right to make changes without further notice to any products herein. ON Semiconductor makes no warranty, representation or guarantee regarding the suitability of its products for any particular purpose, nor does ON Semiconductor assume any liability arising out of the application or use of any product or circuit, and specifically disclaims any and all liability, including without limitation special, consequential or incidental damages. Buyer is responsible for its products and applications using ON Semiconductor products, including compliance with all laws, regulations and safety requirements or standards, regardless of any support or applications information provided by ON Semiconductor. "Typical" parameters which may be provided in ON Semiconductor data sheets and/or specifications can and do vary in different applications and actual performance may vary over time. All operating parameters, including "Typicals" must be validated for each customer application by customer's technical experts. ON Semiconductor does not convey any license under its patent rights nor the rights of others. ON Semiconductor products are not designed, intended, or authorized for use as a critical component in life support systems or any FDA Class 3 medical devices or medical devices with a same or similar classification in a foreign jurisdiction or any devices intended for implantation in the human body. Should Buyer purchase or use ON Semiconductor products for any such unintended or unauthorized application, Buyer shall indemnify and hold ON Semiconductor and its officers, employees, subsidiaries, affiliates, and distributors harmless against all claims, costs, damages, and expenses, and reasonable attorney fees arising out of, directly or indirectly, any claim of personal injury or death associated with such unintended or unauthorized use, even if such claim alleges that ON Semiconductor was negligent regarding the design or manufacture of the part. ON Semiconductor is an Equal Opportunity/Affirmative Action Employer. This literature is subject to all applicable copyright laws and is not for resale in any manner.

## PUBLICATION ORDERING INFORMATION

### LITERATURE FULFILLMENT:

Literature Distribution Center for ON Semiconductor  
19521 E. 32nd Pkwy, Aurora, Colorado 80011 USA  
**Phone:** 303-675-2175 or 800-344-3860 Toll Free USA/Canada  
**Fax:** 303-675-2176 or 800-344-3867 Toll Free USA/Canada  
**Email:** [orderlit@onsemi.com](mailto:orderlit@onsemi.com)

**N. American Technical Support:** 800-282-9855 Toll Free  
USA/Canada  
**Europe, Middle East and Africa Technical Support:**  
Phone: 421 33 790 2910  
**Japan Customer Focus Center**  
Phone: 81-3-5817-1050

**ON Semiconductor Website:** [www.onsemi.com](http://www.onsemi.com)  
**Order Literature:** <http://www.onsemi.com/orderlit>  
For additional information, please contact your local  
Sales Representative



# Mouser Electronics

Authorized Distributor

Click to View Pricing, Inventory, Delivery & Lifecycle Information:

[ON Semiconductor:](#)

[PZTA14](#) [PZTA14\\_F081](#) [PZTA14\\_Q](#)