

# General Specifications

## Electrical Capacity (Resistive Load)

Low/Logic Level: 50mA @ 24V DC

## Other Ratings

<b>Contact Resistance:</b>	50 milliohms maximum
<b>Insulation Resistance:</b>	500 megohms minimum @ 250V DC
<b>Dielectric Strength:</b>	250V AC minimum for 1 minute minimum
<b>Mechanical Life:</b>	500,000 operations minimum
<b>Electrical Life:</b>	500,000 operations minimum
<b>Nominal Operating Force:</b>	1.96N for sculptured actuator 2.0N for piano actuator 3.0N for square & round flush actuators
<b>Total Travel:</b>	Flush Actuators .016" (0.4mm) Sculptured & Piano Actuators .031" (0.8mm)

## Materials & Finishes

<b>Actuator:</b>	Polyamide
<b>Case:</b>	Glass fiber reinforced polyamide
<b>Seal:</b>	Nitrile butadiene rubber
<b>Base:</b>	Glass fiber reinforced polyester
<b>Movable Contact:</b>	Phosphor bronze with silver plating
<b>Stationary Contacts:</b>	Brass with silver plating
<b>Terminals:</b>	Brass with silver plating

## Environmental Data

<b>Operating Temperature Range:</b>	-25°C through +85°C (-13°F through +185°F)
<b>Humidity:</b>	90 ~ 95% humidity for 96 hours @ 40°C (104°F)
<b>Vibration:</b>	10 ~ 55Hz with peak-to-peak amplitude of 1.5mm traversing the frequency range & returning in 1 minute; 3 right angled directions for 2 hours
<b>Shock:</b>	50G (490m/s <sup>2</sup> ) acceleration (tested in 6 right angled directions, with 5 shocks in each direction)

## PCB Processing

<b>Soldering:</b>	Wave Soldering Recommended. See Profile A in Supplement section. Manual Soldering: See Profile A in Supplement section.
<b>Cleaning:</b>	Automated cleaning. See Cleaning specifications in Supplement section.

## Standards & Certifications

The JF Series tactiles have not been tested for UL recognition or CSA certification. These switches are designed for use in a low-voltage, low-current, logic-level circuit. When used as intended in a logic-level circuit, the results do not produce hazardous energy.

# Distinctive Characteristics

Extremely low profile of 5mm from PCB to top of switch.

Rubber seal construction prevents contact contamination and allows automated soldering and cleaning.

Minimal operating force and short stroke permit light touch operation.

Dome contact gives crisp tactile and audible feedback to positively indicate circuit transfer and assures high reliability and long life.

Wide choice of body shapes and colors.

Crimped terminals provide a spring type action to ensure secure mounting and prevent dislodging during wave soldering.

Space saving body dimensions provide for compact, side-by-side mounting on a standard grid.

Terminal spacing conforms to standard .100" (2.54mm) PCB grid.

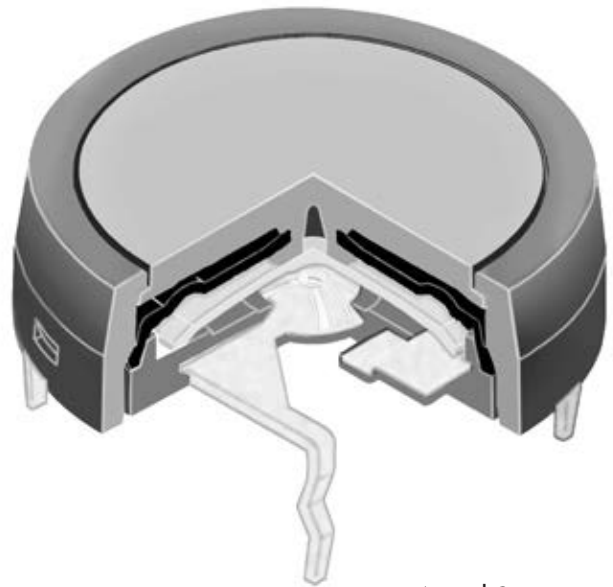

Actual Size



## Common Bus Matrix

These single pole, single throw switches can be used in a keyboard matrix and, using strapped terminals, achieve a common bus electrical configuration on a single-sided PC board.



		PC Terminations												
		1	2	3	4	5	6	7	8	9	10	11	12	13
Keys (Switches)	1													
	2													
	3													
	4													
	5													
	6													
	7													
	8													
	9													
	0													
	A													
	B													

● = ON

## X-Y Matrix

These single pole, single throw switches can be arranged on a single-sided PC board matrix with strapped terminals to achieve an X-Y type electrical interconnection.



		PC Terminations						
		1	2	3	4	5	6	7
Keys (Switches)	1							
	2							
	3							
	4							
	5							
	6							
	7							
	8							
	9							
	0							
	A							
	B							

● = ON

Red = PCB Trace    Black = Switch Circuit

### TYPICAL SWITCH ORDERING EXAMPLE

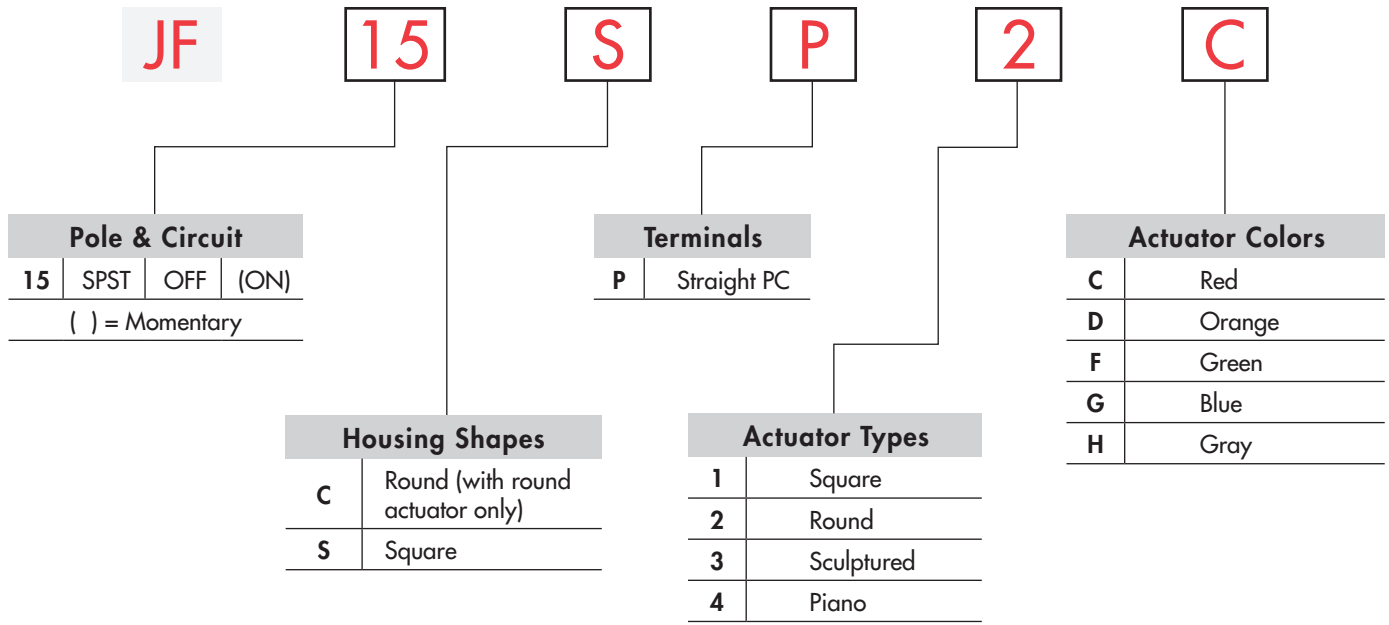

### DESCRIPTION FOR TYPICAL ORDERING EXAMPLE

**JF15SP2C**

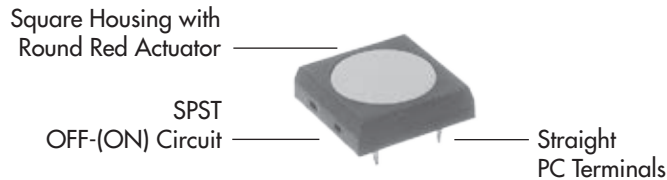

### POLE & CIRCUIT

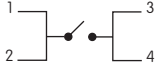
Pole	Model	Actuator Position ( ) = Momentary		Switch Throw & Schematic	Note: Terminal numbers are shown on the switch.
		Normal	Down		
SP	JF15	OFF	(ON)	SPST 	

HOUSING SHAPES & ACTUATOR TYPES

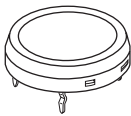
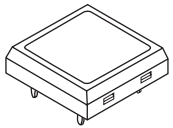
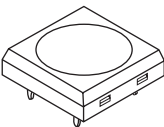
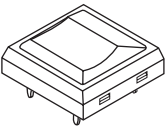
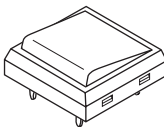
<p><b>C</b> Round Housing</p>	<p><b>S</b> Square Housing</p>			
<p><b>2</b> Round Actuator</p> 	<p><b>1</b> Square Actuator</p> 	<p><b>2</b> Round Actuator</p> 	<p><b>3</b> Sculptured Actuator</p> 	<p><b>4</b> Piano Actuator</p> 

Actuator Colors Available:

**C** Red

**D** Orange

**F** Green

**G** Blue

**H** Gray

Housing is Black

TERMINALS & PANEL DESIGN

**P** Straight PC

Additional details in Typical Switch Dimensions

Versatile panel arrangements can be made to fit individual design needs.

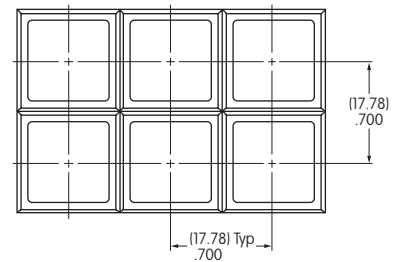
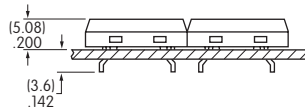
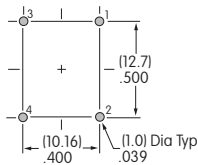
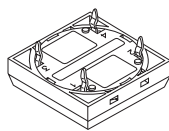

TYPICAL SWITCH DIMENSIONS

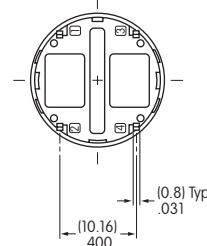
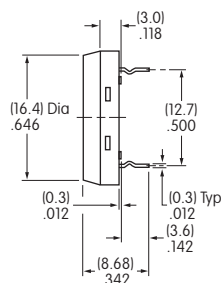
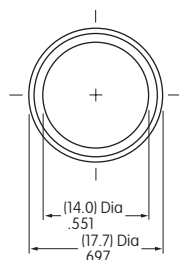

Round Actuator



JF15CP2C

Toggles  
Rockers  
Pushbuttons  
Illuminated PB  
Programmable  
Keylocks  
Rotaries  
Slides  
Tactiles  
Tilt  
Touch  
Indicators  
Accessories  
Supplement

## TYPICAL SWITCH DIMENSIONS

### Square Actuator

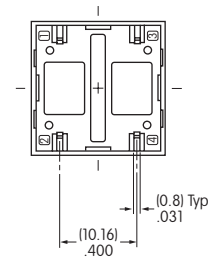
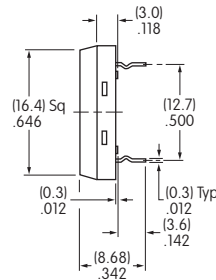
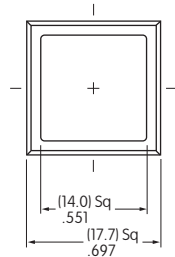

JF15SP1C

### Round Actuator

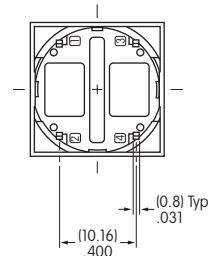
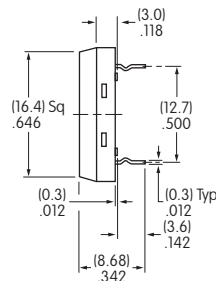
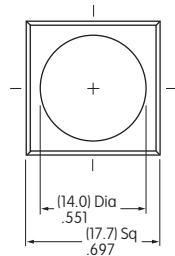
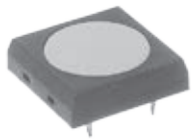

JF15SP2C

### Sculptured Actuator

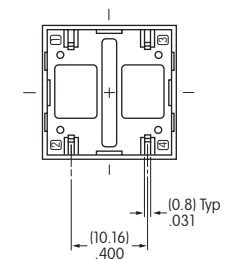
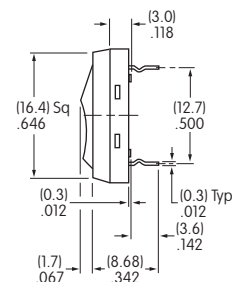
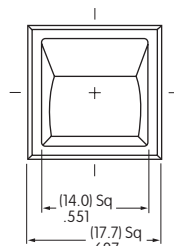

JF15SP3C

### Piano Actuator

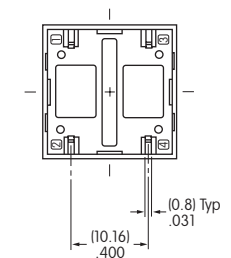
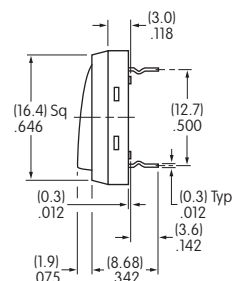
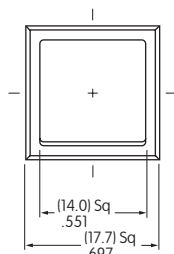

JF15SP4C

LEGENDS

NKK Switches can provide custom legends for caps. Contact factory for more information.

Shaded Areas are Printable Areas

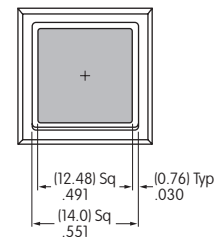
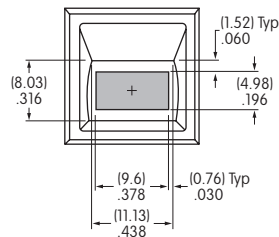
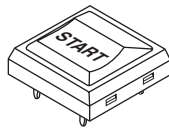
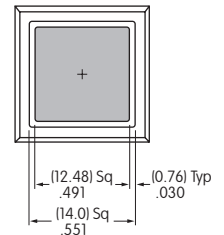
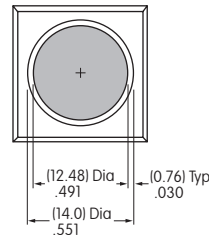
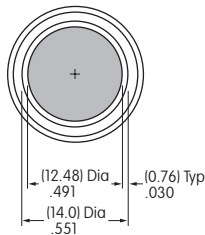
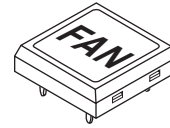

Recommended Print Methods: Screen Print or Pad Print. Epoxy based ink is recommended.

# Mouser Electronics

Authorized Distributor

Click to View Pricing, Inventory, Delivery & Lifecycle Information:

## NKK Switches:

[JF15SP3G](#) [JF15SP4C](#) [JF15SP4H](#) [JF15SP4D](#) [JF15SP2C](#) [JF15SP3F](#) [JF15SP1D](#) [JF15SP1H](#) [JF15SP1F](#)  
[JF15SP3H](#) [JF15SP1C](#) [JF15SP1G](#) [JF15SP3C](#) [JF15CP2C](#) [JF15CP2H](#) [JF15CP2D](#) [JF15CP2F](#) [JF15CP2G](#)  
[JF15SP2G](#) [JF15SP4G](#) [JF15SP1A](#) [JF15SP2D](#) [JF15SP2F](#) [JF15SP2H](#) [JF15SP3D](#) [JF15SP4F](#) [JF15CP2A](#)