

NTHD4102P

Power MOSFET

-20 V, -4.1 A, Dual P-Channel ChipFET™

Features

- Offers an Ultra Low $R_{DS(ON)}$ Solution in the ChipFET Package
- Miniature ChipFET Package 40% Smaller Footprint than TSOP-6
- Low Profile (<1.1 mm) Allows it to Fit Easily into Extremely Thin Environments such as Portable Electronics
- Simplifies Circuit Design since Additional Boost Circuits for Gate Voltages are not Required
- Operated at Standard Logic Level Gate Drive, Facilitating Future Migration to Lower Levels using the same Basic Topology
- Pb-Free Package is Available

Applications

- Optimized for Battery and Load Management Applications in Portable Equipment such as MP3 Players, Cell Phones, and PDAs
- Charge Control in Battery Chargers
- Buck and Boost Converters

MAXIMUM RATINGS ($T_J = 25^\circ\text{C}$ unless otherwise noted)

Parameter		Symbol	Value	Unit
Drain-to-Source Voltage		V_{DSS}	-20	V
Gate-to-Source Voltage		V_{GS}	± 8.0	V
Continuous Drain Current (Note 1)	Steady State	$T_A = 25^\circ\text{C}$	-2.9	A
		$T_A = 85^\circ\text{C}$	-2.1	
	$t \leq 10$ s	$T_A = 25^\circ\text{C}$	-4.1	
Power Dissipation (Note 1)	Steady State	$T_A = 25^\circ\text{C}$	1.1	W
		$t \leq 10$ s	2.1	
Pulsed Drain Current	$t_p = 10$ μs	I_{DM}	-16	A
Operating Junction and Storage Temperature		T_J, T_{STG}	-55 to 150	$^\circ\text{C}$
Source Current (Body Diode)		I_S	-1.1	A
Lead Temperature for Soldering Purposes (1/8" from case for 10 s)		T_L	260	$^\circ\text{C}$

THERMAL RESISTANCE RATINGS

Parameter	Symbol	Max	Unit
Junction-to-Ambient, Steady State (Note 1)	$R_{\theta JA}$	113	$^\circ\text{C/W}$
Junction-to-Ambient, $t \leq 10$ s (Note 1)		60	

Stresses exceeding Maximum Ratings may damage the device. Maximum Ratings are stress ratings only. Functional operation above the Recommended Operating Conditions is not implied. Extended exposure to stresses above the Recommended Operating Conditions may affect device reliability.

1. Surface mounted on FR4 board using 1 in sq pad size (Cu area = 1.127 in sq [1 oz] including traces)



ON Semiconductor®

<http://onsemi.com>

$V_{(BR)DSS}$	$R_{DS(ON)}$ TYP	I_D MAX
-20 V	64 m Ω @ -4.5 V	-4.1 A
	85 m Ω @ -2.5 V	
	120 m Ω @ -1.8 V	

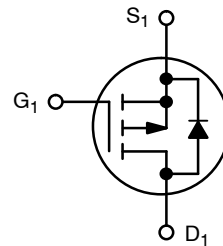

P-Channel MOSFET

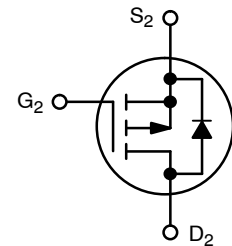

P-Channel MOSFET

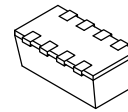

ChipFET
CASE 1206A
STYLE 2

PIN CONNECTIONS

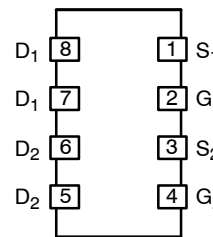

MARKING DIAGRAM

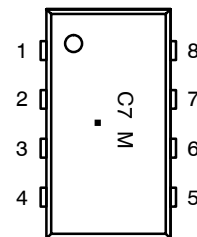

C7 = Specific Device Code
M = Month Code
▪ = Pb-Free Package

ORDERING INFORMATION

Device	Package	Shipping†
NTHD4102PT1	ChipFET	3000/Tape & Reel
NTHD4102PT1G	ChipFET (Pb-Free)	3000/Tape & Reel

†For information on tape and reel specifications, including part orientation and tape sizes, please refer to our Tape and Reel Packaging Specifications Brochure, BRD8011/D.

NTHD4102P

ELECTRICAL CHARACTERISTICS (T_J = 25°C unless otherwise noted)

Characteristic	Symbol	Test Condition	Min	Typ	Max	Unit
----------------	--------	----------------	-----	-----	-----	------

OFF CHARACTERISTICS

Drain-to-Source Breakdown Voltage	V _{(Br)DSS}	V _{GS} = 0 V, I _D = -250 μA	-20			V
Drain-to-Source Breakdown Voltage Temperature Coefficient	V _{(Br)DSS} /T _J			-15		mV/°C
Zero Gate Voltage Drain Current	I _{DSS}	V _{GS} = 0 V V _{DS} = -16 V	T _J = 25°C		-1.0	μA
			T _J = 85°C		-5.0	
Gate-to-Source Leakage Current	I _{GSS}	V _{DS} = 0 V, V _{GS} = ±8.0 V			±100	nA

ON CHARACTERISTICS (Note 2)

Gate Threshold Voltage	V _{GS(TH)}	V _{GS} = V _{DS} , I _D = -250 μA	-0.45		-1.5	V
Gate Threshold Temperature Coefficient	V _{GS(TH)} /T _J			2.7		mV/°C
Drain-to-Source On Resistance	R _{DS(ON)}	V _{GS} = -4.5 V, I _D = -2.9 A		64	80	mΩ
		V _{GS} = -2.5 V, I _D = -2.2 A		85	110	
		V _{DS} = -1.8 V, I _D = -1.0 A		120	170	
Forward Transconductance	g _{FS}	V _{DS} = -10 V, I _D = -2.9 A		7.0		S

CHARGES, CAPACITANCES, AND GATE RESISTANCE

Input Capacitance	C _{ISS}	V _{GS} = 0 V, f = 1.0 MHz, V _{DS} = -16 V		750		pF
Output Capacitance	C _{OSS}			100		
Reverse Transfer Capacitance	C _{RSS}			45		
Total Gate Charge	Q _{G(TOT)}	V _{GS} = -4.5 V, V _{DS} = -16 V, I _D = -2.6 A		7.6	8.6	nC
Gate-to-Source Charge	Q _{GS}			1.3		
Gate-to-Drain Charge	Q _{GD}			2.6		

SWITCHING CHARACTERISTICS (Note 3)

Turn-On Delay Time	t _{d(ON)}	V _{GS} = -4.5 V, V _{DD} = -16 V, I _D = -2.6 A, R _G = 2.0 Ω		5.5	10	ns
Rise Time	t _r			12	25	
Turn-Off Delay Time	t _{d(OFF)}			32	40	
Fall Time	t _f			23	35	

DRAIN-SOURCE DIODE CHARACTERISTICS

Forward Diode Voltage	V _{SD}	V _{GS} = 0 V, I _S = -1.1 A		-0.8	-1.2	V
Reverse Recovery Time	t _{RR}	V _{GS} = 0 V, di _S /dt = 100 A/μs, I _S = 1.0 A		20	40	ns
Charge Time	t _a			15		
Discharge Time	t _b			5		
Reverse Recovery Charge	Q _{RR}			0.01		

2. Pulse test: pulse width ≤ 300 μs, duty cycle ≤ 2%

3. Switching characteristics are independent of operating junction temperatures

NTHD4102P

TYPICAL PERFORMANCE CURVES ($T_J = 25^\circ\text{C}$ unless otherwise noted)

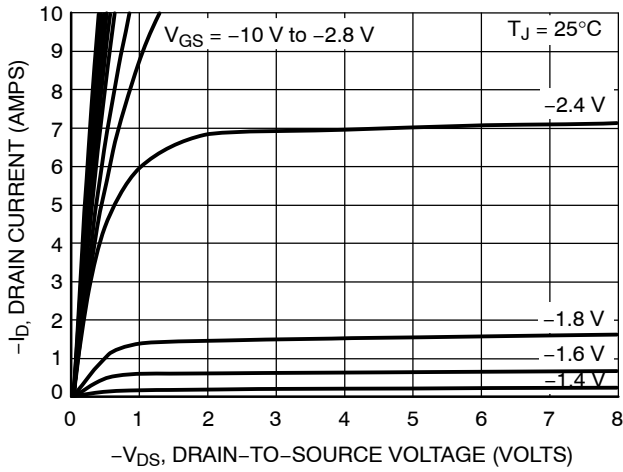

Figure 1. On-Region Characteristics

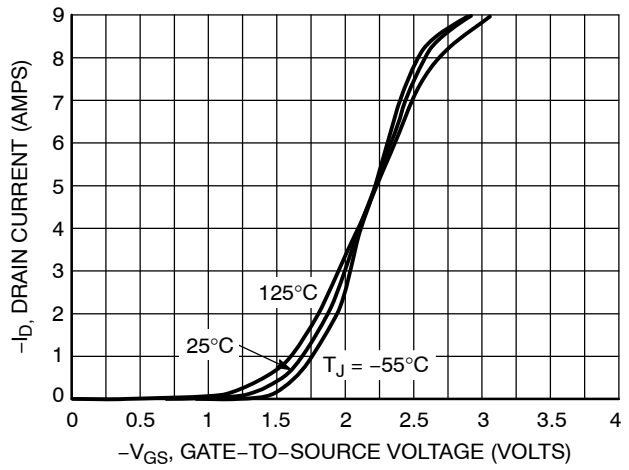

Figure 2. Transfer Characteristics

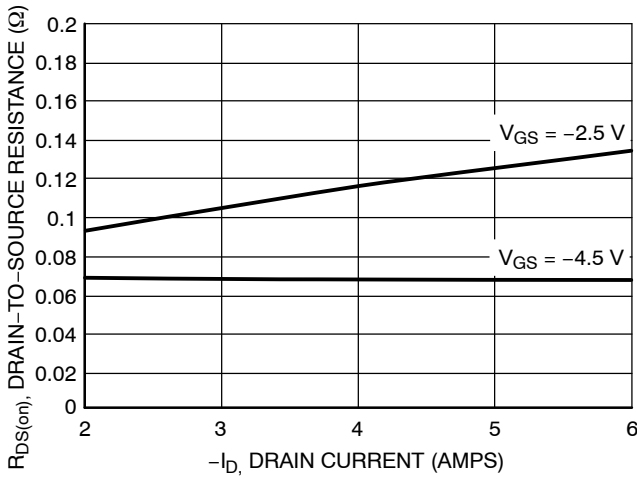

Figure 3. On-Resistance vs. Drain Current and Gate Voltage

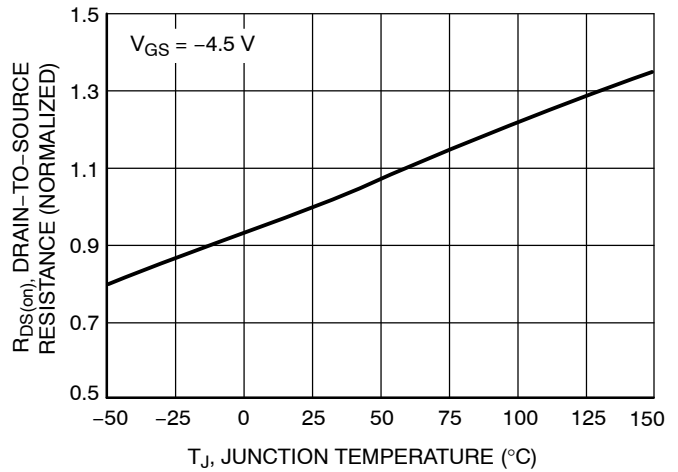

Figure 4. On-Resistance Variation with Temperature

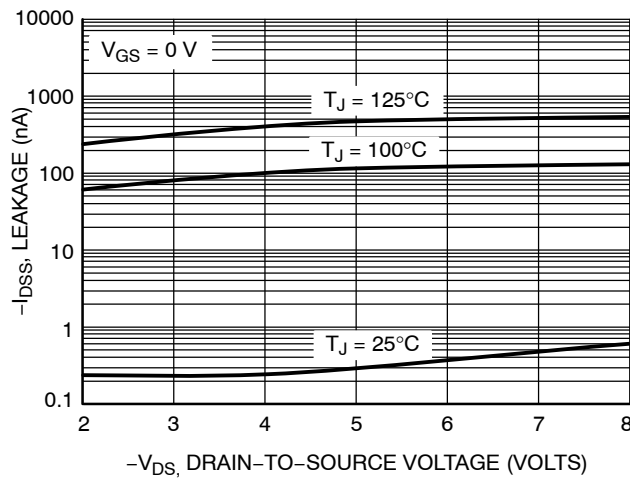

Figure 5. Drain-to-Source Leakage Current vs. Voltage

TYPICAL PERFORMANCE CURVES ($T_J = 25^\circ\text{C}$ unless otherwise noted)

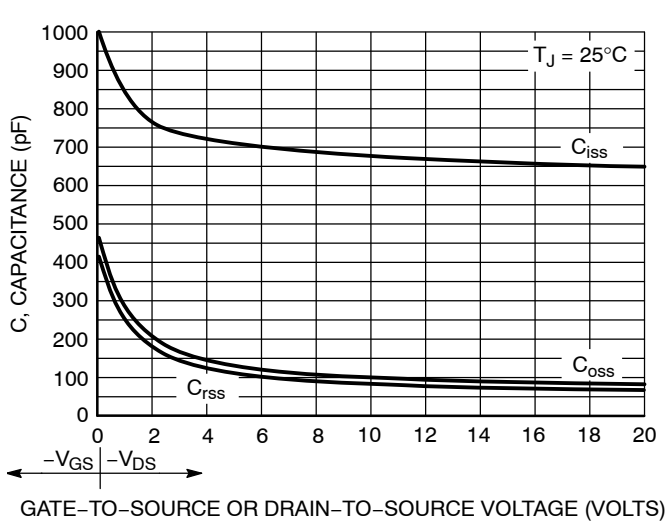

Figure 6. Capacitance Variation

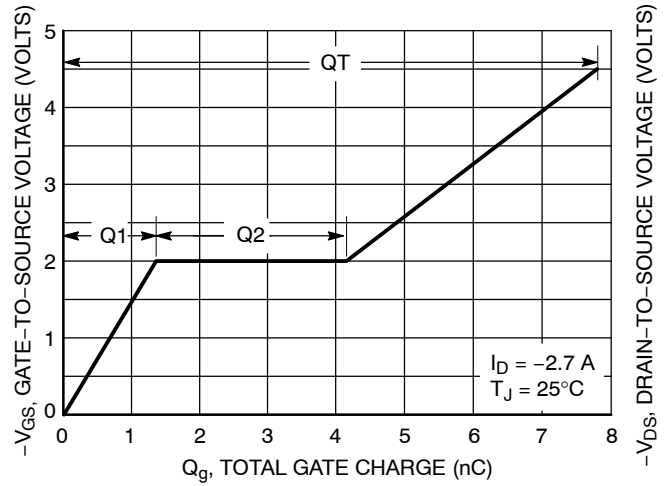

Figure 7. Gate-to-Source and Drain-to-Source Voltage vs. Total Gate Charge

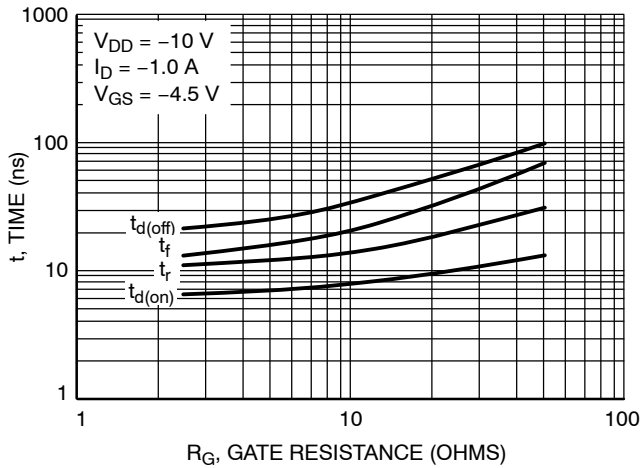

Figure 8. Resistive Switching Time Variation vs. Gate Resistance

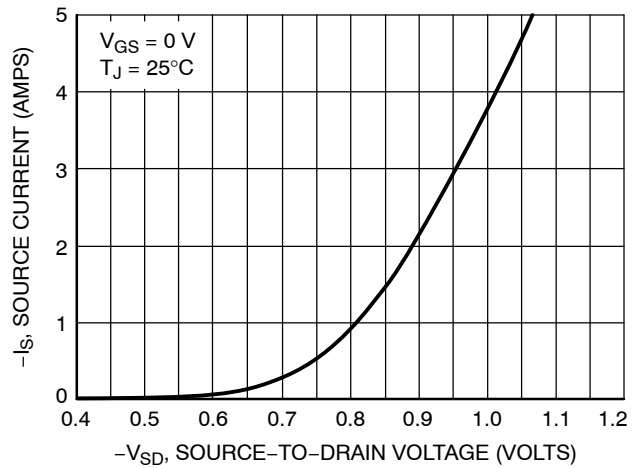

Figure 9. Diode Forward Voltage vs. Current

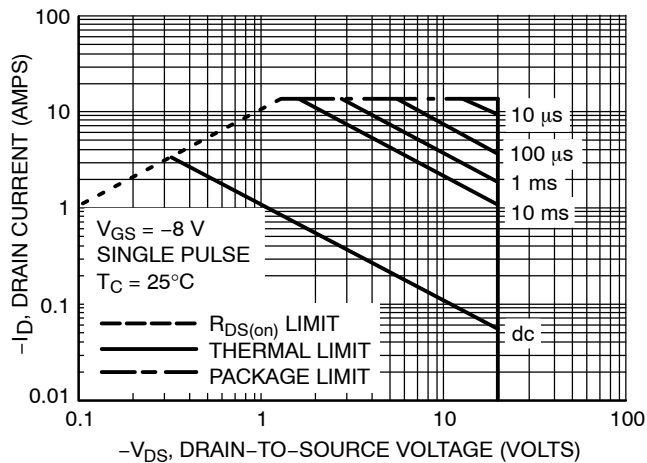
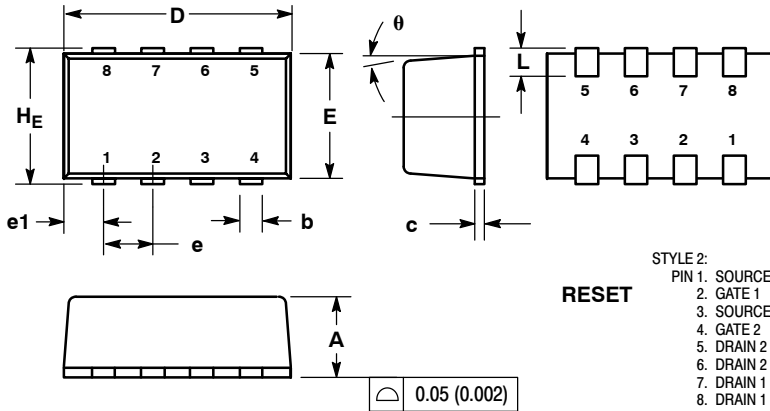

Figure 10. Maximum Rated Forward Biased Safe Operating Area

NTHD4102P

PACKAGE DIMENSIONS

ChipFET™
CASE 1206A-03
ISSUE K



NOTES:

1. DIMENSIONING AND TOLERANCING PER ANSI Y14.5M, 1982.
2. CONTROLLING DIMENSION: MILLIMETER.
3. MOLD GATE BURRS SHALL NOT EXCEED 0.13 MM PER SIDE.
4. LEADFRAME TO MOLDED BODY OFFSET IN HORIZONTAL AND VERTICAL SHALL NOT EXCEED 0.08 MM.
5. DIMENSIONS A AND B EXCLUSIVE OF MOLD GATE BURRS.
6. NO MOLD FLASH ALLOWED ON THE TOP AND BOTTOM LEAD SURFACE.

DIM	MILLIMETERS			INCHES		
	MIN	NOM	MAX	MIN	NOM	MAX
A	1.00	1.05	1.10	0.039	0.041	0.043
b	0.25	0.30	0.35	0.010	0.012	0.014
c	0.10	0.15	0.20	0.004	0.006	0.008
D	2.95	3.05	3.10	0.116	0.120	0.122
E	1.55	1.65	1.70	0.061	0.065	0.067
e	0.65 BSC			0.025 BSC		
e1	0.55 BSC			0.022 BSC		
L	0.28	0.35	0.42	0.011	0.014	0.017
HE	1.80	1.90	2.00	0.071	0.075	0.079
θ	5° NOM			5° NOM		

SOLDERING FOOTPRINT*

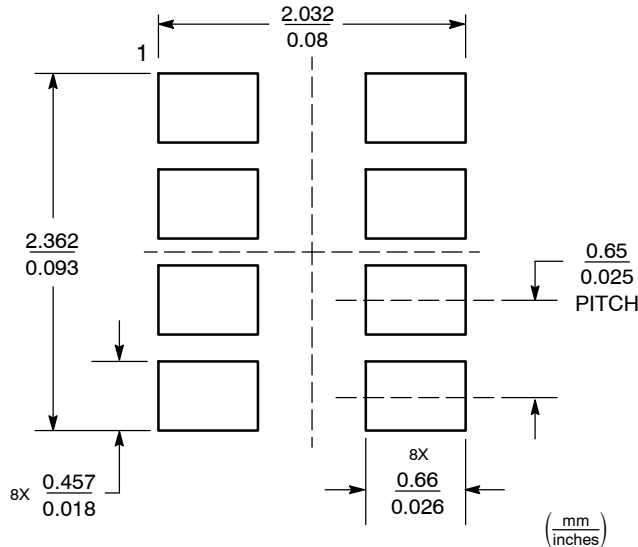

*For additional information on our Pb-Free strategy and soldering details, please download the ON Semiconductor Soldering and Mounting Techniques Reference Manual, SOLDERRM/D.

ChipFET is a trademark of Vishay Siliconix.

ON Semiconductor and are registered trademarks of Semiconductor Components Industries, LLC (SCILLC). SCILLC reserves the right to make changes without further notice to any products herein. SCILLC makes no warranty, representation or guarantee regarding the suitability of its products for any particular purpose, nor does SCILLC assume any liability arising out of the application or use of any product or circuit, and specifically disclaims any and all liability, including without limitation special, consequential or incidental damages. "Typical" parameters which may be provided in SCILLC data sheets and/or specifications can and do vary in different applications and actual performance may vary over time. All operating parameters, including "Typicals" must be validated for each customer application by customer's technical experts. SCILLC does not convey any license under its patent rights nor the rights of others. SCILLC products are not designed, intended, or authorized for use as components in systems intended for surgical implant into the body, or other applications intended to support or sustain life, or for any other application in which the failure of the SCILLC product could create a situation where personal injury or death may occur. Should Buyer purchase or use SCILLC products for any such unintended or unauthorized application, Buyer shall indemnify and hold SCILLC and its officers, employees, subsidiaries, affiliates, and distributors harmless against all claims, costs, damages, and expenses, and reasonable attorney fees arising out of, directly or indirectly, any claim of personal injury or death associated with such unintended or unauthorized use, even if such claim alleges that SCILLC was negligent regarding the design or manufacture of the part. SCILLC is an Equal Opportunity/Affirmative Action Employer. This literature is subject to all applicable copyright laws and is not for resale in any manner.

PUBLICATION ORDERING INFORMATION

LITERATURE FULFILLMENT:
Literature Distribution Center for ON Semiconductor
P.O. Box 61312, Phoenix, Arizona 85082-1312 USA
Phone: 480-829-7710 or 800-344-3860 Toll Free USA/Canada
Fax: 480-829-7709 or 800-344-3867 Toll Free USA/Canada
Email: orderlit@onsemi.com

N. American Technical Support: 800-282-9855 Toll Free
USA/Canada

Japan: ON Semiconductor, Japan Customer Focus Center
2-9-1 Kamimeguro, Meguro-ku, Tokyo, Japan 153-0051
Phone: 81-3-5773-3850

ON Semiconductor Website: <http://onsemi.com>

Order Literature: <http://www.onsemi.com/litorder>

For additional information, please contact your local Sales Representative.

NTHD4102P/D

Mouser Electronics

Authorized Distributor

Click to View Pricing, Inventory, Delivery & Lifecycle Information:

[ON Semiconductor:](#)

[NTHD4102PT1G](#)