

| LOC | | DIST | | REVISIONS | | | |
|-----|-----|---------------------------|-----------|-----------|------|--|--|
| P | LTN | DESCRIPTION | DATE | DWN | APVD | | |
| B1 | | REVISED PER ECO-16-014766 | 12OCT2016 | RS | GJ | | |

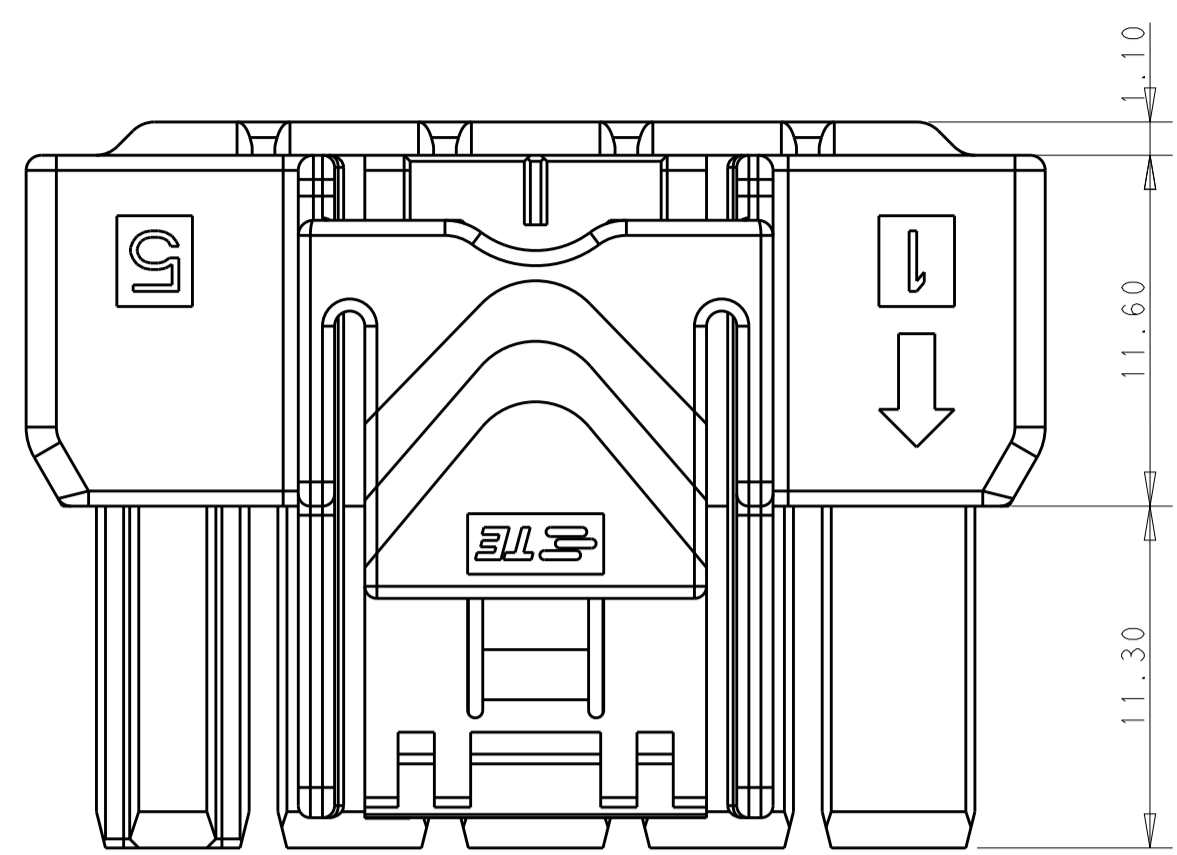

| POS. | DIM. A |
|------|--------|
| 3*5 | 33.70 |
| 3*4 | 27.70 |
| 3*3 | 21.70 |

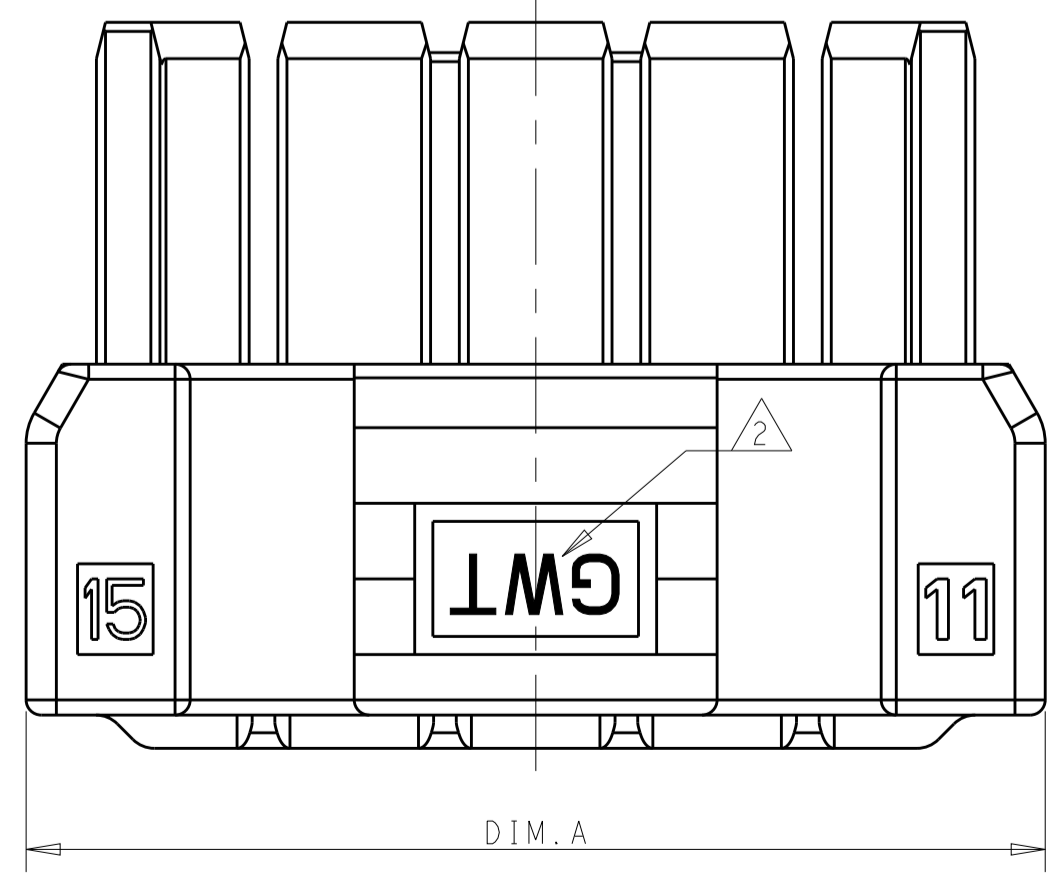
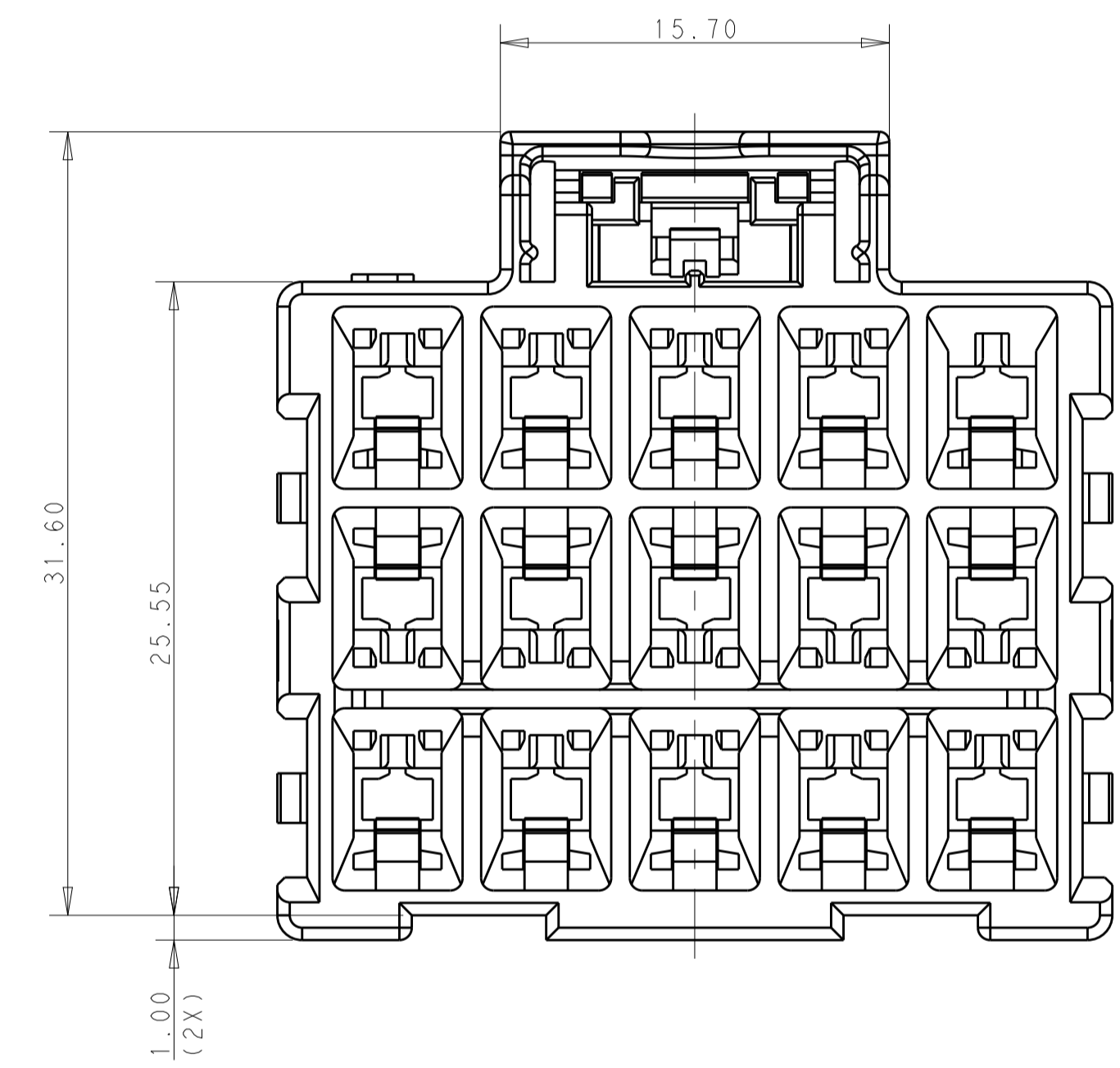
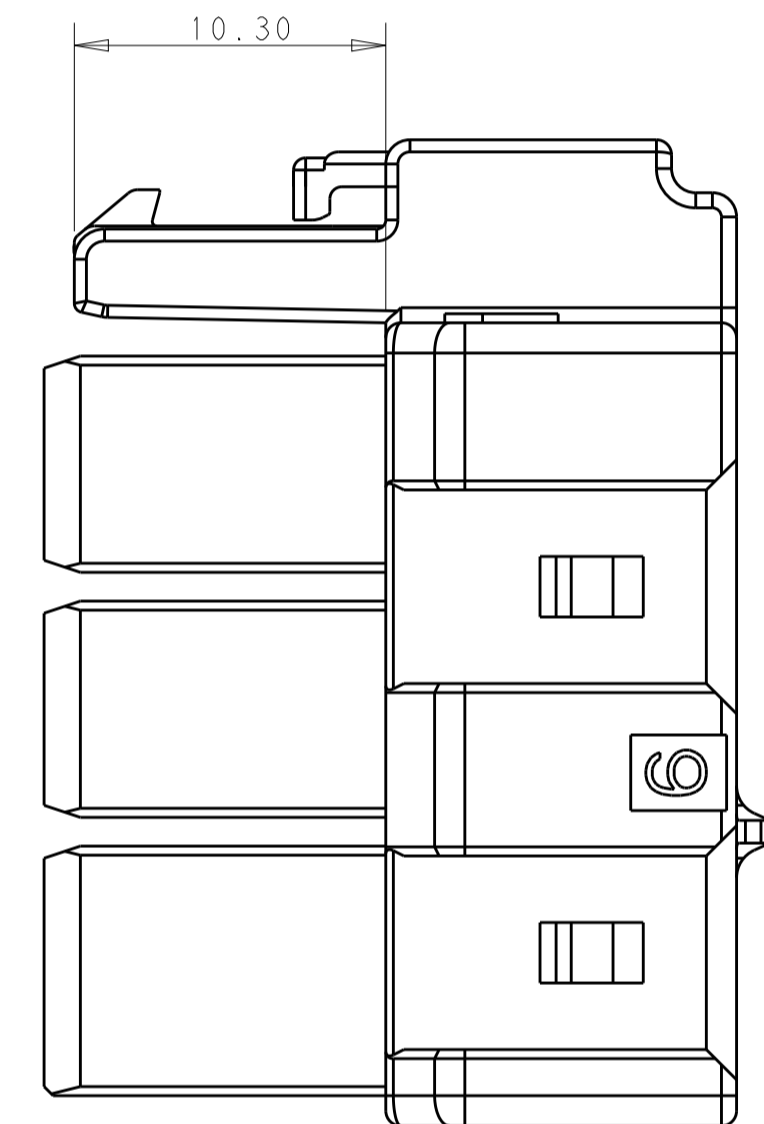
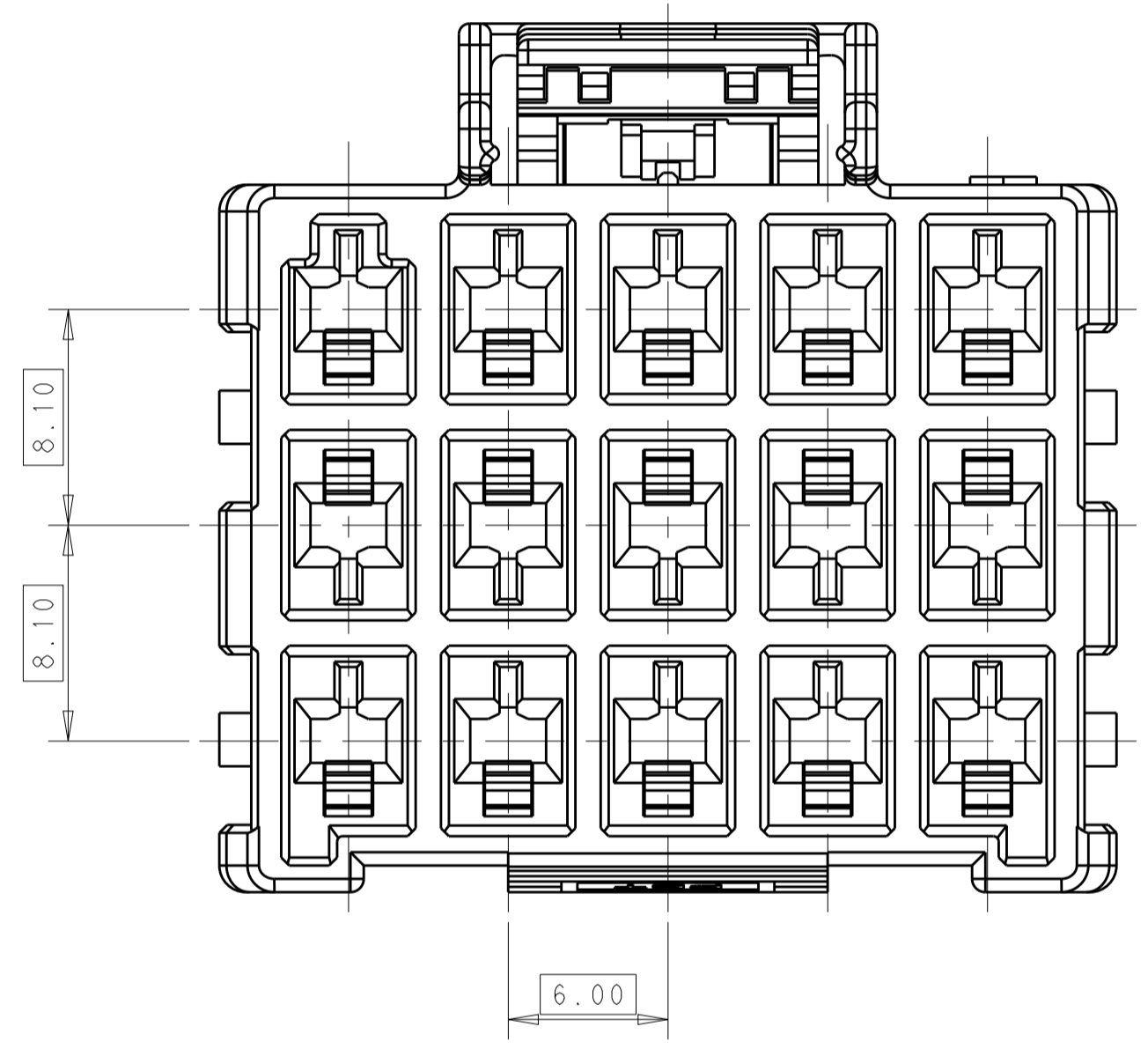

1 MATERIAL:
 LEVEL A: PA6, COMPLY WITH GLOW WIRE REQUIREMENTS FOR PARTS OF NON-METALLIC MATERIAL SUPPORTING A CURRENT-CARRYING CONNECTION DETAILED IN IEC 60335-1, SECTION 30 (GWT), UL 94V-0
 LEVEL B: PBT, HOT WIRE IGNITION (HWI) VERSION ARE MOLDED IN A RESIN THAT COMPLIES WITH TE HOT WIRE IGNITION TEST 109-32026 AND ARE RECOMMENDED FOR USE WITH HWI HOUSINGS THAT ALSO COMPLY, UL 94V-0

2 MATERIAL MARK:
 LEVEL A: GWT, LEVEL B: HWT

3. APPLICABLE CONTACT P/N
 RECEPTACLE CONTACT: 1971237/1971779/81/83/85/87-*; 2238066-*

4. MATING CONN. P/N
 CAP HSG: *-2232356/60-*
 DOUBLE ROW TPA: *-1971778-*; SINGLE ROW TPA: *-1971777-*

5. THIS PRODUCT HAS NOT COMPLETED VALIDATION TESTING.

| | | | |
|--|-------------|----------------------------|---|
| THIS DRAWING IS A CONTROLLED DOCUMENT. | | DWN: TOMMY_WU 26MAR2013 | TE Connectivity NAME: PLUG HOUSING, TRIPLE ROW POWER TRIPLE LOCK |
| DIMENSIONS: | | CHK: HAPYE_WU 26MAR2013 | |
| TOLERANCES UNLESS OTHERWISE SPECIFIED: | | APVD: YIHONG_MAO 26MAR2013 | |
| mm | 0 PLC ± | PRODUCT SPEC | SIZE: CAGE CODE DRAWING NO |
| | 1 PLC ±0.35 | 108-106118 | RESTRICTED TO |
| | 2 PLC ±0.25 | APPLICATION SPEC | A100779C=2232357 |
| | 3 PLC ± | | SCALE 3:1 SHEET 1 OF 2 REV B1 |
| | 4 PLC ± | | |
| | ANGLES ± | | |
| MATERIAL | FINISH | WEIGHT | |
| | | | Customer Drawing |

| LOC | | DIST | | REVISIONS | | | |
|---------------|-----|-------------|------|-----------|------|--|--|
| P | LTN | DESCRIPTION | DATE | OWN | APVD | | |
| -SEE SHEET 1- | | | | | | | |

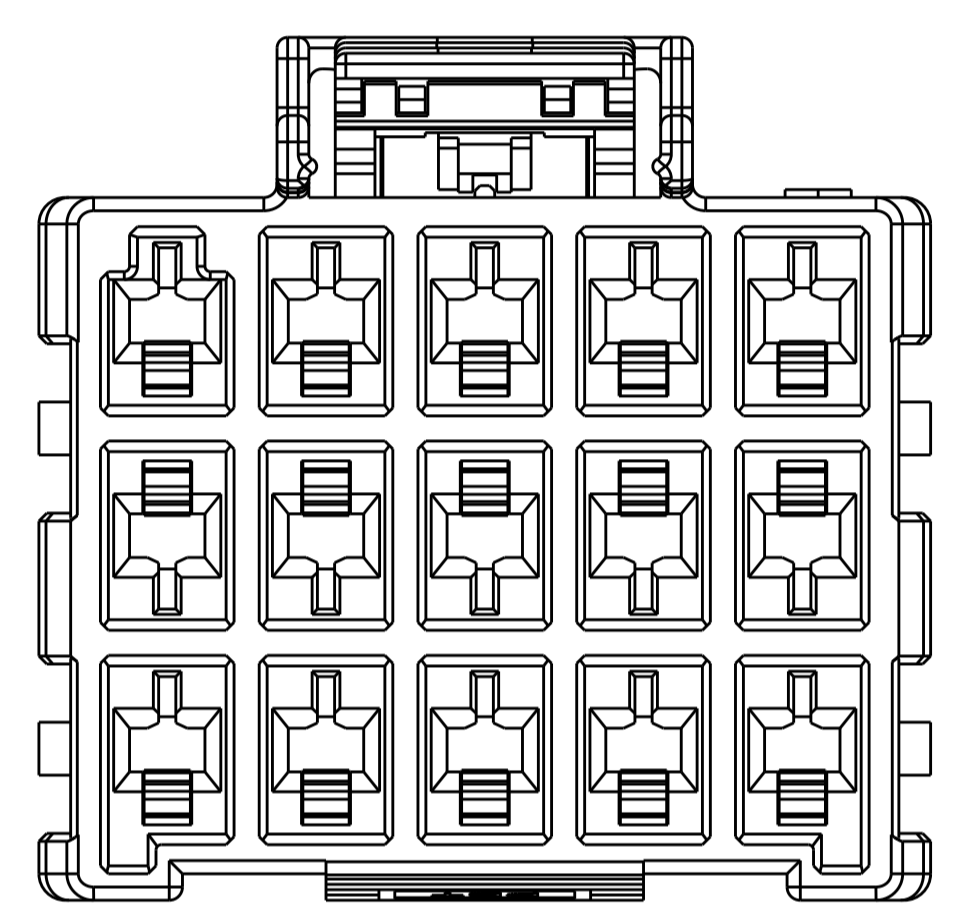
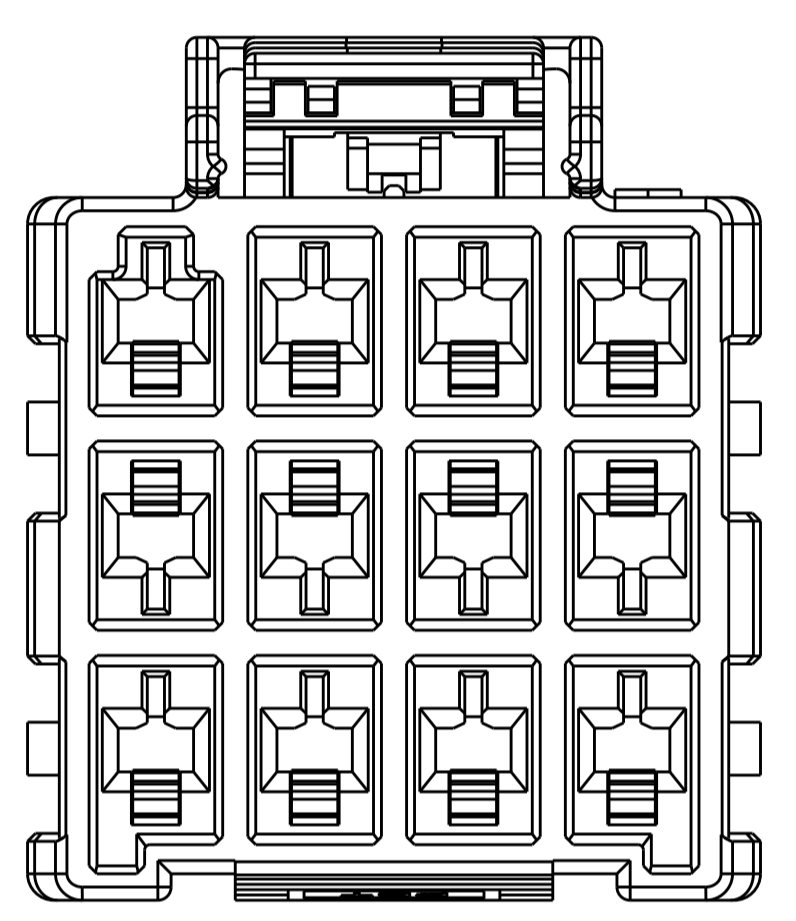
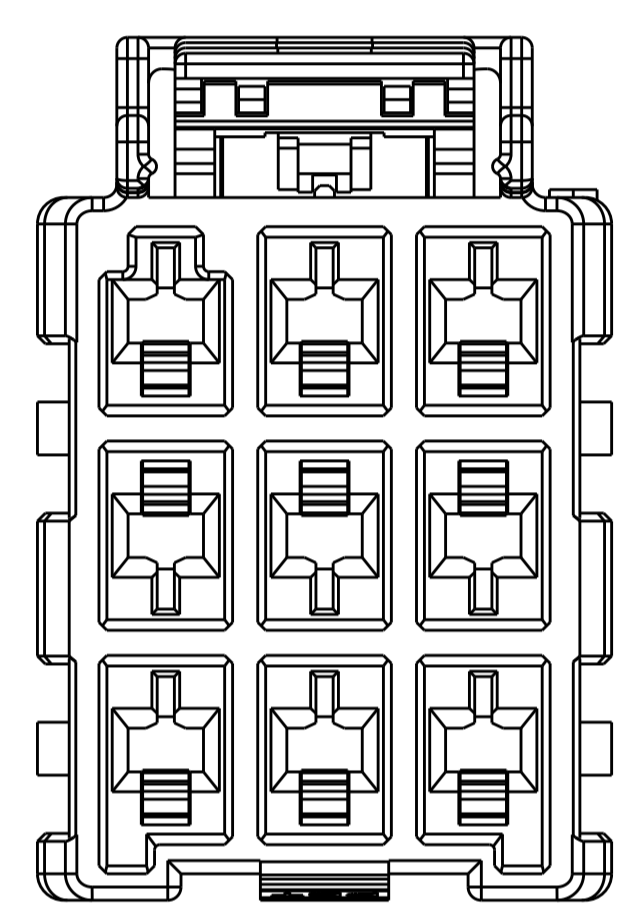
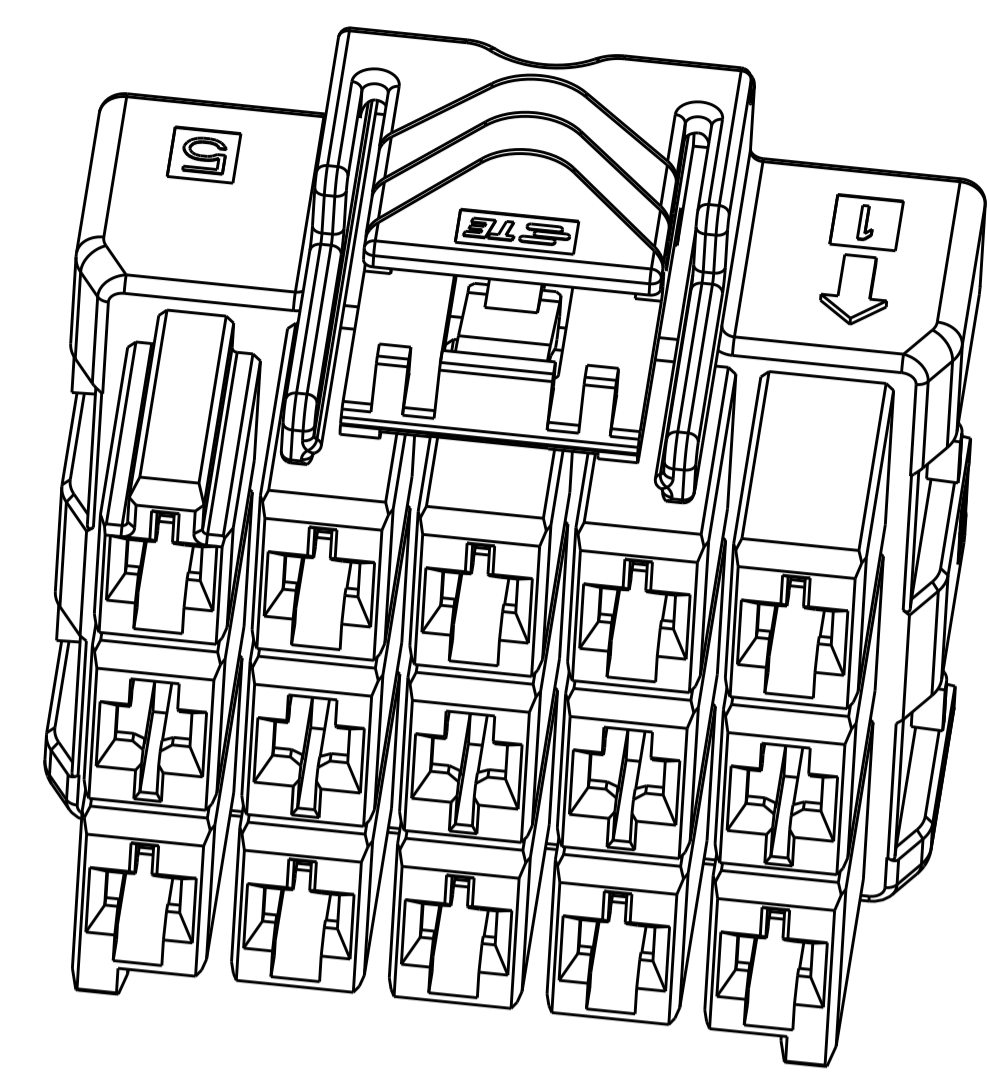
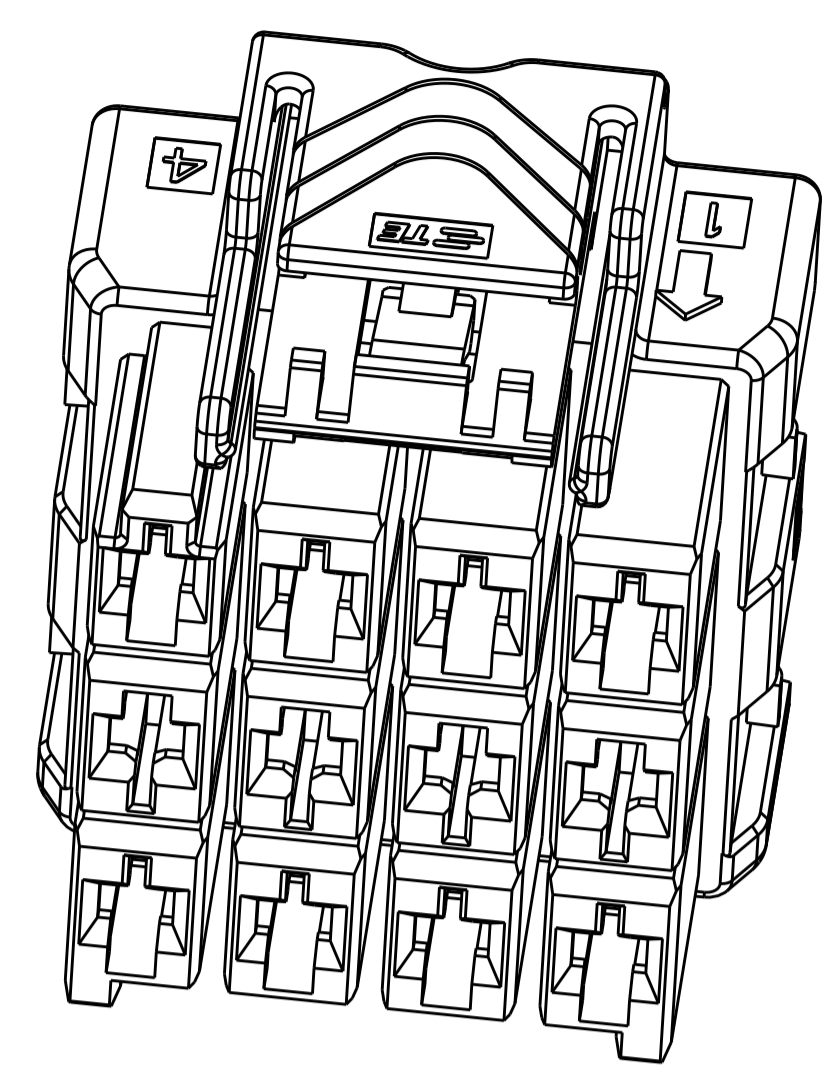
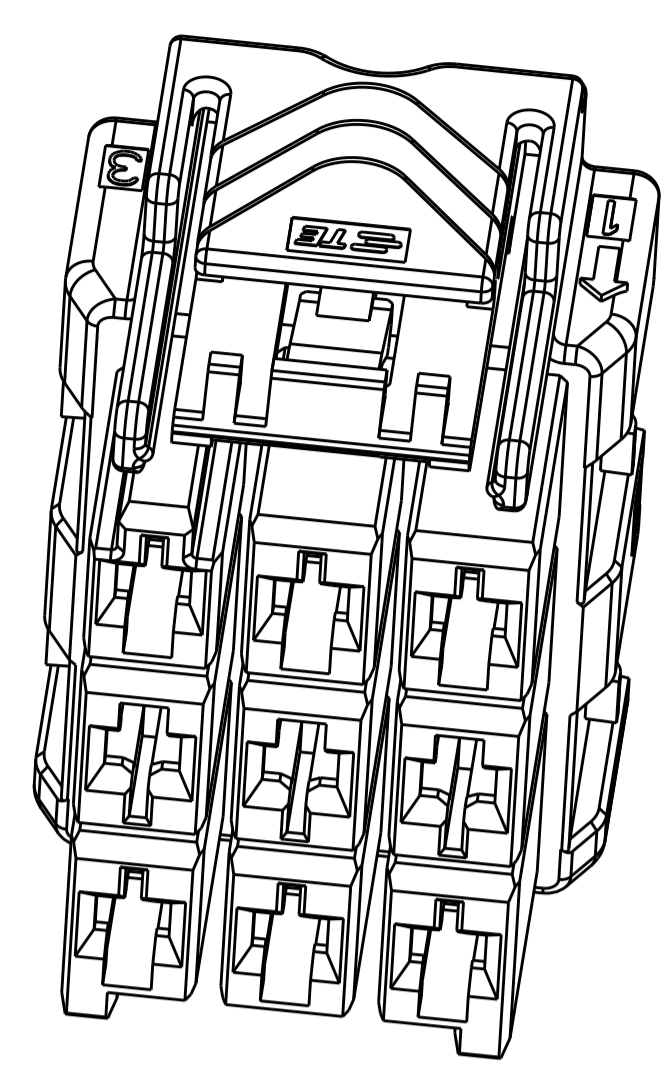

| POS. | MATERIAL | COLOR | KEY | P/N |
|------|----------|-----------|-------|-------------|
| 3*5 | LEVEL A | DARK GREY | KEY A | 5-2232357-7 |
| | | BROWN | KEY B | 6-2232357-7 |
| | | GREEN | KEY C | 7-2232357-7 |
| | | ORANGE | KEY D | 8-2232357-7 |
| 3*4 | LEVEL A | BLACK | KEY A | 1-2232357-5 |
| | | DARK GREY | KEY A | 5-2232357-4 |
| | | BROWN | KEY B | 6-2232357-4 |
| | | GREEN | KEY C | 7-2232357-4 |
| 3*3 | LEVEL A | ORANGE | KEY D | 8-2232357-4 |
| | | BLACK | KEY A | 1-2232357-4 |
| | | DARK GREY | KEY A | 5-2232357-3 |
| | | BROWN | KEY B | 6-2232357-3 |
| 3*3 | LEVEL A | GREEN | KEY C | 7-2232357-3 |
| | | ORANGE | KEY D | 8-2232357-3 |
| | | BLACK | KEY A | 1-2232357-6 |

3*3 POSITIONS

3*4 POSITIONS

3*5 POSITIONS

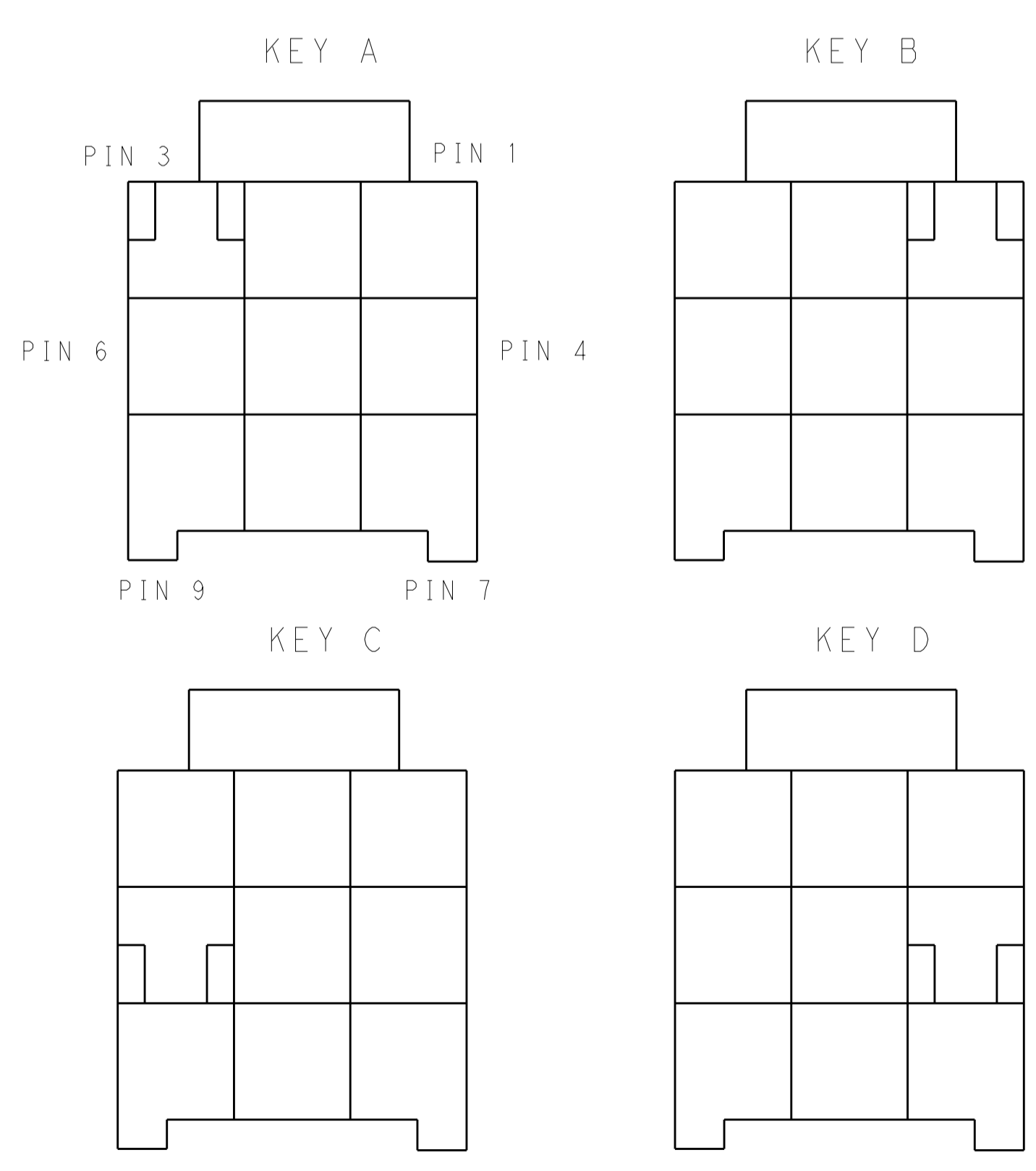

KEYING FOR 3*3 POS.

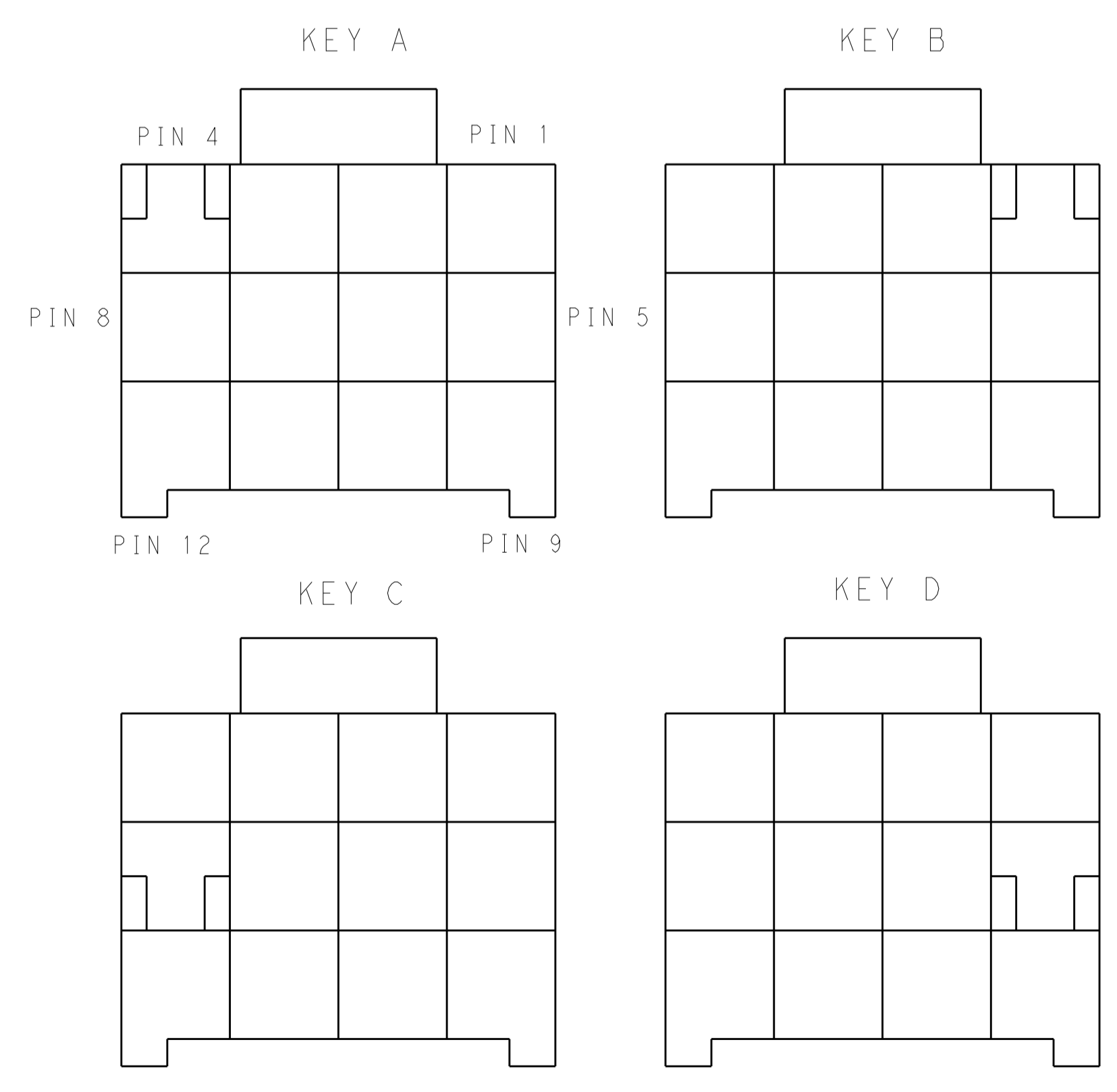

KEYING FOR 3*4 POS.

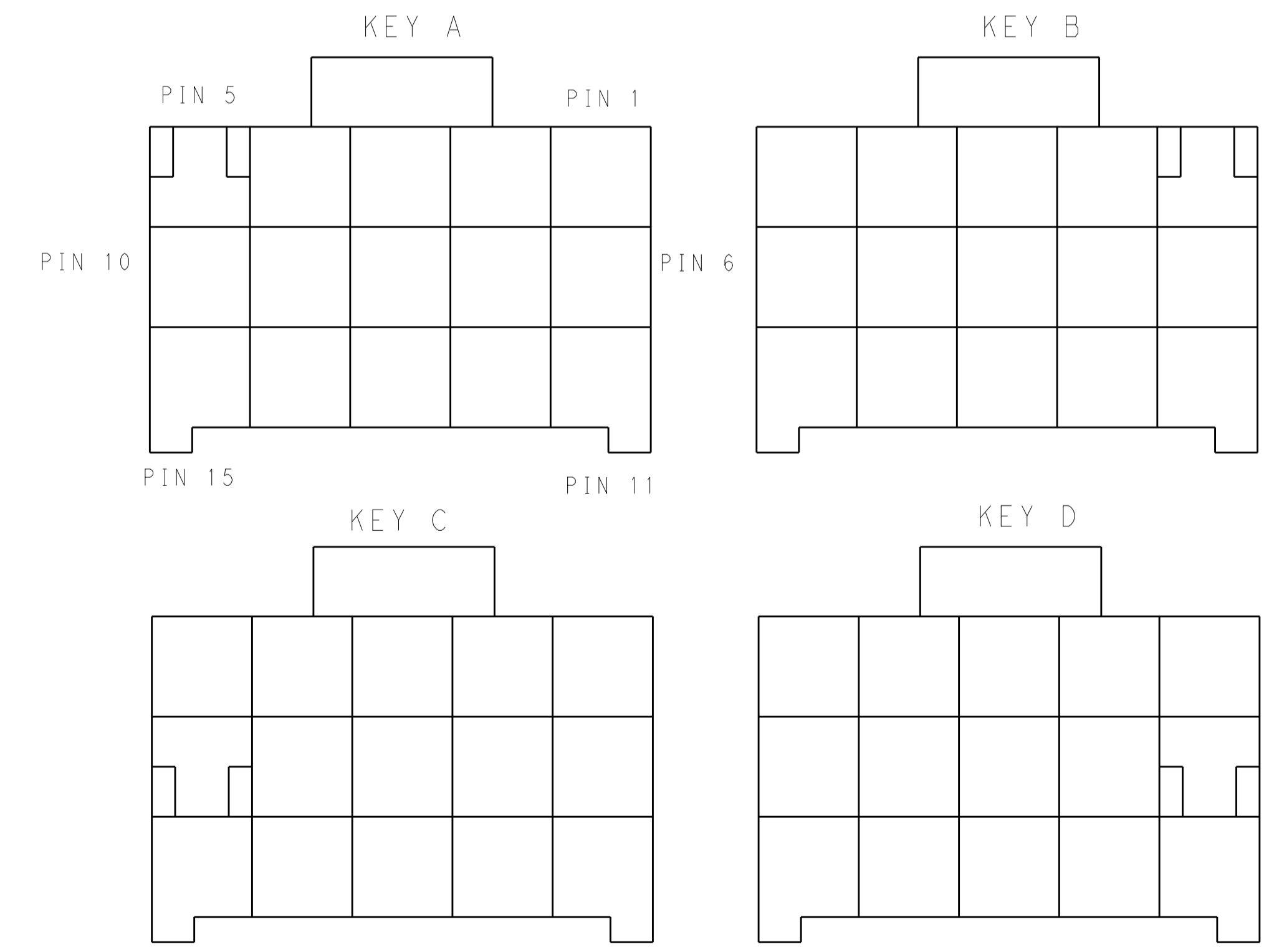

KEYING FOR 3*5 POS.

THIS DRAWING IS A CONTROLLED DOCUMENT.

| | | | | | |
|-------------|---|--------------------------|------------------------------|----------------------------|------------------|
| DIMENSIONS: | TOLERANCES UNLESS OTHERWISE SPECIFIED: | OWN: TOMMY_WU 26MAR2013 | CHK: HAPYE_WU 26MAR2013 | APVD: YIHONG_MAO 26MAR2013 | NAME: YIHONG_MAO |
| mm | 0 PLC ±.1 1 PLC ±0.35 2 PLC ±0.25 3 PLC ±.1 4 PLC ±.1 ANGLES ±.1 | PRODUCT SPEC: 108-106118 | APPLICATION SPEC: 114-106118 | WEIGHT: - | SIZE: A1 |
| MATERIAL: - | FINISH: - | Customer Drawing | SCALE: - | SHEET 2 OF 2 | REV B1 |

STE TE Connectivity
PLUG HOUSING, TRIPLE ROW
POWER TRIPLE LOCK

Mouser Electronics

Authorized Distributor

Click to View Pricing, Inventory, Delivery & Lifecycle Information:

[TE Connectivity:](#)

[5-2232357-7](#)