

# High Current Density Surface Mount Glass Passivated Fast Switching Rectifier

eSMP® Series



SMP (DO-220AA)

Cathode Anode

**DESIGN SUPPORT TOOLS**
[click logo to get started](#)

PRIMARY CHARACTERISTICS	
$I_{F(AV)}$	1.0 A
$V_{RRM}$	100 V, 200 V, 400 V, 600 V
$I_{FSM}$	30 A
$t_{rr}$	150 ns, 250 ns
$I_R$	1 $\mu$ A
$V_F$	1.3 V
$T_J$ max.	150 °C
Package	SMP (DO-220AA)
Circuit configuration	Single

**FEATURES**

- Very low profile - typical height of 1.0 mm
- Ideal for automated placement
- Glass passivated pellet chip junction
- Fast switching for high efficiency
- Low thermal resistance
- High forward surge capability
- Meets MSL level 1, per J-STD-020, LF maximum peak of 260 °C
- AEC-Q101 qualified available
  - Automotive ordering code; base P/NHM3
- Material categorization: for definitions of compliance please see [www.vishay.com/doc?99912](http://www.vishay.com/doc?99912)

 AUTOMOTIVE  
GRADE  
Available

**RoHS**  
COMPLIANT  
HALOGEN  
**FREE**
**TYPICAL APPLICATIONS**

For use in fast switching rectification of power supply, inverters, converters, and freewheeling diodes for consumer, automotive and telecommunication.

**MECHANICAL DATA**
**Case:** SMP (DO-220AA)

Molding compound meets UL 94 V-0 flammability rating  
Base P/N-M3 - halogen-free, RoHS-compliant, and commercial grade

Base P/NHM3 - halogen-free, RoHS-compliant, and AEC-Q101 qualified

Base P/NHM3\_X - halogen-free, RoHS-compliant, and AEC-Q101 qualified

("\_X" denotes revision code e.g. A, B,.....)

**Terminals:** matte tin plated leads, solderable per J-STD-002 and JESD 22-B102

M3 and HM3 suffix meets JESD 201 class 2 whisker test

**Polarity:** color band denotes the cathode end

MAXIMUM RATINGS ( $T_A = 25$ °C unless otherwise noted)						
PARAMETER	SYMBOL	RS1PB	RS1PD	RS1PG	RS1PJ	UNIT
Device marking code		RB	RD	RG	RJ	
Maximum repetitive peak reverse voltage	$V_{RRM}$	100	200	400	600	V
Maximum average forward rectified current (fig. 1)	$I_{F(AV)}$	1.0				A
Peak forward surge current 10 ms single half sine-wave superimposed on rated load	$I_{FSM}$	30				A
Operating junction and storage temperature range	$T_J, T_{STG}$	-55 to +150				°C



ELECTRICAL CHARACTERISTICS (T <sub>A</sub> = 25 °C unless otherwise noted)							
PARAMETER	TEST CONDITIONS	SYMBOL	RS1PB	RS1PD	RS1PG	RS1PJ	UNIT
Maximum instantaneous forward voltage	I <sub>F</sub> = 1.0 A	V <sub>F</sub> <sup>(1)</sup>	1.3				V
Maximum reverse current at rated V <sub>R</sub> voltage	T <sub>A</sub> = 25 °C T <sub>A</sub> = 125 °C	I <sub>R</sub> <sup>(2)</sup>	1.0				μA
			60				
Maximum reverse recovery time	I <sub>F</sub> = 0.5 A, I <sub>R</sub> = 1.0 A, I <sub>rr</sub> = 0.25 A	t <sub>rr</sub>	150			250	ns
Typical junction capacitance	4.0 V, 1 MHz	C <sub>J</sub>	9				pF

**Notes**

- (1) Pulse test: 300 μs pulse width, 1 % duty cycle
- (2) Pulse test: Pulse width ≤ 40 ms

THERMAL CHARACTERISTICS (T <sub>A</sub> = 25 °C unless otherwise noted)						
PARAMETER	SYMBOL	RS1PB	RS1PD	RS1PG	RS1PJ	UNIT
Typical thermal resistance	R <sub>θJA</sub> <sup>(1)</sup>	115				°C/W
	R <sub>θJL</sub> <sup>(1)</sup>	15				
	R <sub>θJC</sub> <sup>(1)</sup>	20				

**Note**

- (1) Thermal resistance from junction to ambient and junction to lead mounted on PCB with 5.0 mm x 5.0 mm copper pad areas. R<sub>θJL</sub> is measured at the terminal of cathode band. R<sub>θJC</sub> is measured at the top center of the body

ORDERING INFORMATION (Example)				
PREFERRED P/N	UNIT WEIGHT (g)	PREFERRED PACKAGE CODE	BASE QUANTITY	DELIVERY MODE
RS1PB-M3/84A	0.024	84A	3000	7" diameter plastic tape and reel
RS1PB-M3/85A	0.024	85A	10 000	13" diameter plastic tape and reel
RS1PBHM3/84A <sup>(1)</sup>	0.024	84A	3000	7" diameter plastic tape and reel
RS1PBHM3/85A <sup>(1)</sup>	0.024	85A	10 000	13" diameter plastic tape and reel
RS1PBHM3_A/H <sup>(1)</sup>	0.024	H	3000	7" diameter plastic tape and reel
RS1PBHM3_A/I <sup>(1)</sup>	0.024	I	10 000	13" diameter plastic tape and reel

**Note**

- (1) AEC-Q101 qualified

**RATINGS AND CHARACTERISTICS CURVES (T<sub>A</sub> = 25 °C unless otherwise noted)**

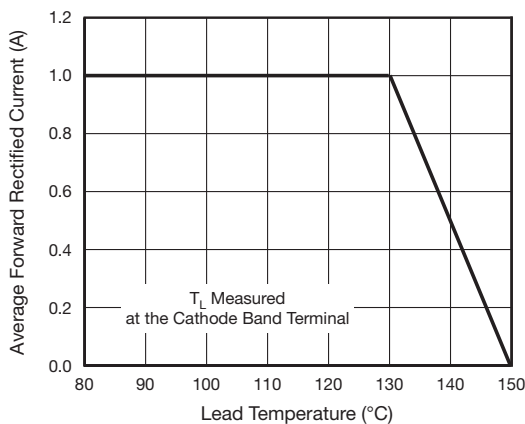

Fig. 1 - Maximum Forward Current Derating Curve

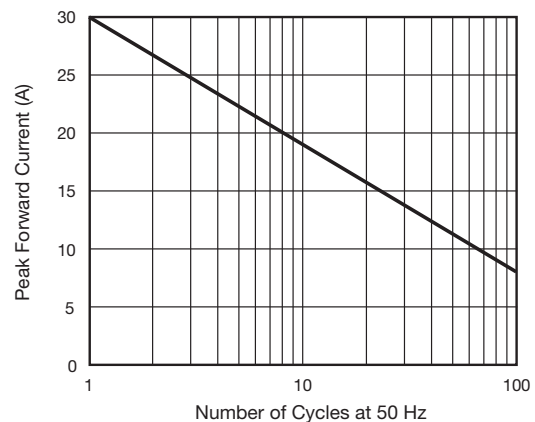

Fig. 2 - Maximum Non-Repetitive Peak Forward Surge Current

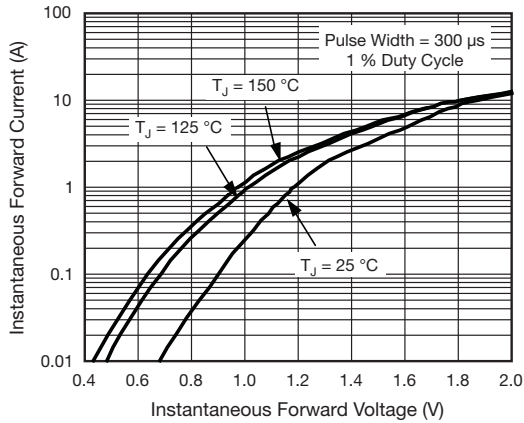

Fig. 3 - Typical Instantaneous Forward Characteristics

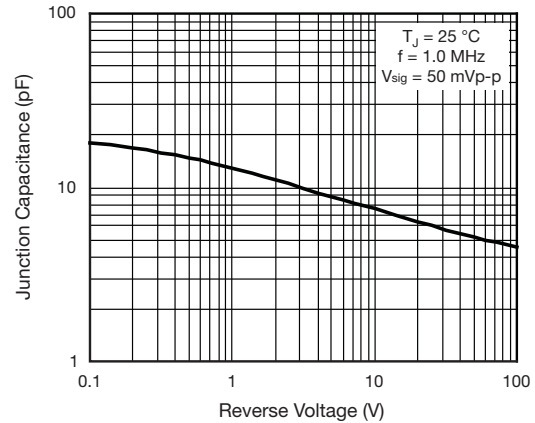

Fig. 5 - Typical Junction Capacitance

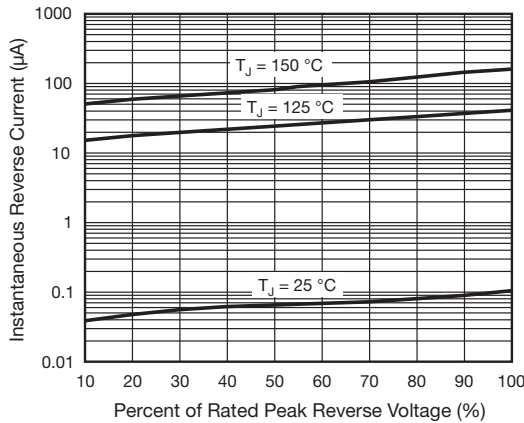

Fig. 4 - Typical Reverse Characteristics

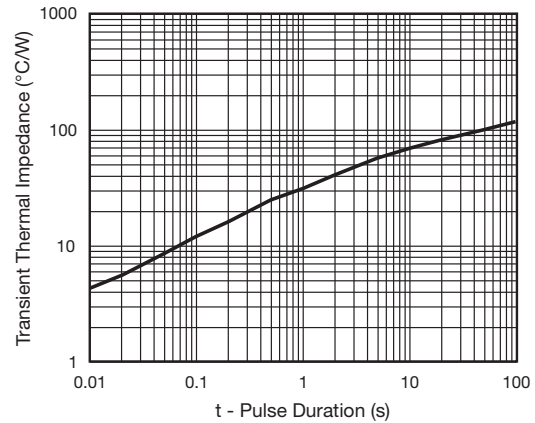
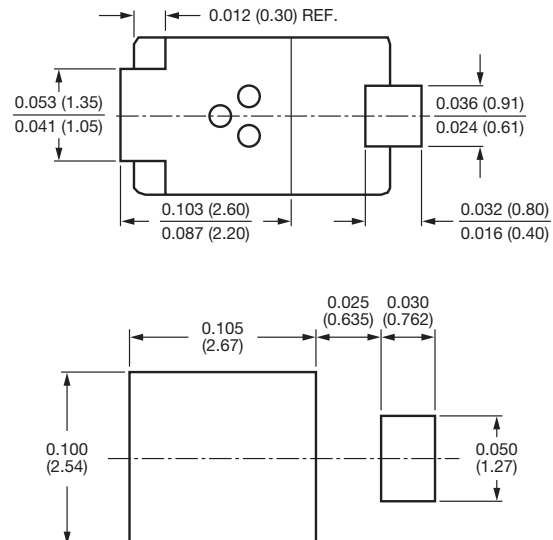
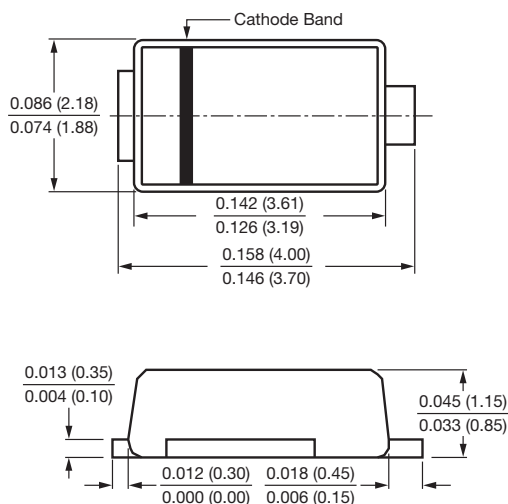

Fig. 6 - Typical Transient Thermal Impedance

## PACKAGE OUTLINE DIMENSIONS in inches (millimeters)

### SMP (DO-220AA)





## **Disclaimer**

ALL PRODUCT, PRODUCT SPECIFICATIONS AND DATA ARE SUBJECT TO CHANGE WITHOUT NOTICE TO IMPROVE RELIABILITY, FUNCTION OR DESIGN OR OTHERWISE.

Vishay Intertechnology, Inc., its affiliates, agents, and employees, and all persons acting on its or their behalf (collectively, "Vishay"), disclaim any and all liability for any errors, inaccuracies or incompleteness contained in any datasheet or in any other disclosure relating to any product.

Vishay makes no warranty, representation or guarantee regarding the suitability of the products for any particular purpose or the continuing production of any product. To the maximum extent permitted by applicable law, Vishay disclaims (i) any and all liability arising out of the application or use of any product, (ii) any and all liability, including without limitation special, consequential or incidental damages, and (iii) any and all implied warranties, including warranties of fitness for particular purpose, non-infringement and merchantability.

Statements regarding the suitability of products for certain types of applications are based on Vishay's knowledge of typical requirements that are often placed on Vishay products in generic applications. Such statements are not binding statements about the suitability of products for a particular application. It is the customer's responsibility to validate that a particular product with the properties described in the product specification is suitable for use in a particular application. Parameters provided in datasheets and / or specifications may vary in different applications and performance may vary over time. All operating parameters, including typical parameters, must be validated for each customer application by the customer's technical experts. Product specifications do not expand or otherwise modify Vishay's terms and conditions of purchase, including but not limited to the warranty expressed therein.

Except as expressly indicated in writing, Vishay products are not designed for use in medical, life-saving, or life-sustaining applications or for any other application in which the failure of the Vishay product could result in personal injury or death. Customers using or selling Vishay products not expressly indicated for use in such applications do so at their own risk. Please contact authorized Vishay personnel to obtain written terms and conditions regarding products designed for such applications.

No license, express or implied, by estoppel or otherwise, to any intellectual property rights is granted by this document or by any conduct of Vishay. Product names and markings noted herein may be trademarks of their respective owners.

# Mouser Electronics

Authorized Distributor

Click to View Pricing, Inventory, Delivery & Lifecycle Information:

[Vishay:](#)

[RS1PB-E3/84A](#) [RS1PB-E3/85A](#) [RS1PBHE3/84A](#) [RS1PBHE3/85A](#) [RS1PD-E3/84A](#) [RS1PD-E3/85A](#)  
[RS1PDHE3/84A](#) [RS1PDHE3/85A](#) [RS1PG-E3/84A](#) [RS1PG-E3/85A](#) [RS1PGHE3/84A](#) [RS1PGHE3/85A](#) [RS1PJ-](#)  
[E3/84A](#) [RS1PJ-E3/85A](#) [RS1PJHE3/84A](#) [RS1PJHE3/85A](#) [RS1PG-M3/84A](#) [RS1PD-M3/84A](#) [RS1PGHM3/85A](#)  
[RS1PJHM3/85A](#) [RS1PB-M3/85A](#) [RS1PDHM3/85A](#) [RS1PJHM3/84A](#) [RS1PB-M3/84A](#) [RS1PBHM3/85A](#) [RS1PJ-](#)  
[M3/84A](#) [RS1PGHM3/84A](#) [RS1PBHM3/84A](#) [RS1PG-M3/85A](#) [RS1PJ-M3/85A](#) [RS1PDHM3/84A](#) [RS1PD-M3/85A](#)