

Type RP73 Series

Key Features

High precision -
Tolerance down to 0.05%
and TCR down to 5PPM

Power rating to 1.0W
Up to 200V DC operating
voltage

Terminal finish –
electroplated 100% matte
Sn



Applications

Communications

Industrial Controls

Instrumentation

Medical

The RP73 resistor series is a stable thin film chip resistor range offering increased power dissipation, higher temperature capabilities and increased working voltages compared to the standard RN73 series. The resistor is produced by sputtering a metal film onto high grade alumina and protecting with three complete printed layers. Values are normally offered in E96 and E24 series. The RP73 resistor has accurate and uniform physical dimensions to reduce placement problems.

Electrical Characteristics RP73 series

Rated Power @ 70°C	0.063W														
Resistance range Ω	Min	49R9	49R9			49R9	49R9	49R9	10R	49R9	49R9	49R9	4R7		
	Max	4K99	12K			4K99	60K	69K8	255K	4K99	60K	69K8	511K		
Tolerance (%)	0.05					0.1					0.5 / 1				
Code Letter	A					B					D / F				
TCR (PPM / °C)	5	10	15	25	50	5	10	15	25	50	5	10	15	25	50
Code Letter	A	C	D	F	G	A	C	D	F	G	A	C	D	F	G
Selection series	E24 & E96														
Max. operating voltage	25V														
Max overload voltage	50V														
Operating temperature range	-55 ~ +155°C														
Insulation resistance	>1000MΩ														
Stability	0.5%														

Rated Power @ 70°C		0603 0.1W														
Resistance range Ω	Min	24R9	4R7			24R9	4R7			4R7	24R9	4R7			4R7	
	Max	15K	332K			15K	332K			1M0	15K	332K			1M0	
Tolerance (%)		0.05					0.1					0.5 / 1				
Code Letter		A					B					D / F				
TCR (PPM / °C)		5	10	15	25	50	5	10	15	25	50	5	10	15	25	50
Code Letter		A	C	D	F	G	A	C	D	F	G	A	C	D	F	G
Selection series		E24 & E96														
Max. operating voltage		75V														
Max overload voltage		150V														
Operating temperature range		-55 ~ +155°C														
Insulation resistance		>1000MΩ														
Stability		0.5%														

Rated Power @ 70°C		0805 0.125W														
Resistance range Ω	Min	24R9	4R7			24R9	4R7	4R7	4R7	24R9	4R7	4R7	1R0			
	Max	30K	511K			30K	511K	1M0	1M0	30K	511K	1M0	1M0			
Tolerance (%)		0.05					0.1					0.5 / 1				
Code Letter		A					B					D / F				
TCR (PPM / °C)		5	10	15	25	50	5	10	15	25	50	5	10	15	25	50
Code Letter		A	C	D	F	G	A	C	D	F	G	A	C	D	F	G
Selection series		E24 & E96														
Max. operating voltage		150V														
Max overload voltage		300V														
Operating temperature range		-55 ~ +155°C														
Insulation resistance		>1000MΩ														
Stability		0.5%														

Rated Power @ 70°C		1206 0.25W														
Resistance range Ω	Min	24R9	4R7			24R9	4R7			24R9	4R7					
	Max	49K9	1M0			49K9	1M0			49K9	1M0					
Tolerance (%)		0.05					0.1					0.5 / 1				
Code Letter		A					B					D / F				
TCR (PPM / °C)		5	10	15	25	50	5	10	15	25	50	5	10	15	25	50
Code Letter		A	C	D	F	G	A	C	D	F	G	A	C	D	F	G
Selection series		E24 & E96														
Max. operating voltage		200V														
Max overload voltage		400V														
Operating temperature range		-55 ~ +155°C														
Insulation resistance		>1000MΩ														
Stability		0.5%														

Rated Power @ 70°C		1210 0.33W														
Resistance range Ω	Min	24R9	4R7				24R9	4R7				24R9	4R7			
	Max	49K9	1M0				49K9	1M0				49K9	1M0			
Tolerance (%)		0.05					0.1					0.5 / 1				
Code Letter		A					B					D / F				
TCR (PPM / °C)		5	10	15	25	50	5	10	15	25	50	5	10	15	25	50
Code Letter		A	C	D	F	G	A	C	D	F	G	A	C	D	F	G
Selection series		E24 & E96														
Max. operating voltage		200V														
Max overload voltage		400V														
Operating temperature range		-55 ~ +155°C														
Insulation resistance		>1000MΩ														
Stability		0.5%														

Rated Power @ 70°C		2010 0.33W														
Resistance range Ω	Min	24R9	4R7				24R9	4R7				24R9	4R7			
	Max	49K9	1M0				49K9	1M0				49K9	1M0			
Tolerance (%)		0.05					0.1					0.5 / 1				
Code Letter		A					B					D / F				
TCR (PPM / °C)		5	10	15	25	50	5	10	15	25	50	5	10	15	25	50
Code Letter		A	C	D	F	G	A	C	D	F	G	A	C	D	F	G
Selection series		E24 & E96														
Max. operating voltage		200V														
Max overload voltage		400V														
Operating temperature range		-55 ~ +155°C														
Insulation resistance		>1000MΩ														
Stability		0.5%														

Rated Power @ 70°C		2512 1.0W					
Resistance range Ω	Min	4R7		1R0		1R0	
	Max	100R		100R		100R	
Tolerance (%)		0.1		0.5		1.0	
Code Letter		B		D		F	
TCR (PPM / °C)		25	50	25	50	25	50
Code Letter		F	G	F	G	F	G
Selection series		E24 & E96					
Max. operating voltage		200V					
Max overload voltage		400V					
Operating temperature range		-55 ~ +155°C					
Insulation resistance		>1000MΩ					
Stability		0.5%					

Operating Voltage= $\sqrt{P \cdot R}$ or Max. operating voltage listed above, whichever is lower.
 Overload Voltage= $2.5 \cdot \sqrt{P \cdot R}$ or Max. overload voltage listed above, whichever is lower.

Electrical Characteristics RP73P series – High Power

		0402					
Rated Power @ 70°C		0.1W					
Resistance range Ω	Min	10R		4R7		4R7	
	Max	255K		255K		255K	
Tolerance (%)		0.1		0.5		1.0	
Code Letter		B		D		F	
TCR (PPM / °C)		25	50	25	50	25	50
Code Letter		F	G	F	G	F	G
Selection series		E24 & E96					
Max. operating voltage		50V					
Max overload voltage		100V					
Operating temperature range		-55 ~ +155°C					
Insulation resistance		>1000MΩ					
Stability		0.5%					

		0603					
Rated Power @ 70°C		0.166W					
Resistance range Ω	Min	10R		10R		10R	
	Max	332K		332K		332K	
Tolerance (%)		0.1		0.5		1.0	
Code Letter		B		D		F	
TCR (PPM / °C)		25	50	25	50	25	50
Code Letter		F	G	F	G	F	G
Selection series		E24 & E96					
Max. operating voltage		100V					
Max overload voltage		150V					
Operating temperature range		-55 ~ +155°C					
Insulation resistance		>1000MΩ					
Stability		0.5%					

		0805					
Rated Power @ 70°C		0.25W					
Resistance range Ω	Min	10R		10R		10R	
	Max	499K		499K		499K	
Tolerance (%)		0.1		0.5		1.0	
Code Letter		B		D		F	
TCR (PPM / °C)		25	50	25	50	25	50
Code Letter		F	G	F	G	F	G
Selection series		E24 & E96					
Max. operating voltage		150V					
Max overload voltage		300V					
Operating temperature range		-55 ~ +155°C					
Insulation resistance		>1000MΩ					
Stability		0.5%					

		1206					
Rated Power @ 70°C		0.33W					
Resistance range Ω	Min	10R		10R		10R	
	Max	1M0		1M0		1M0	
Tolerance (%)		0.1		0.5		1.0	
Code Letter		B		D		F	
TCR (PPM / °C)		25	50	25	50	25	50
Code Letter		F	G	F	G	F	G
Selection series		E24 & E96					
Max. operating voltage		200V					
Max overload voltage		400V					
Operating temperature range		-55 ~ +155°C					
Insulation resistance		>1000MΩ					
Stability		0.5%					

Operating Voltage= $\sqrt{P \cdot R}$ or Max. operating voltage listed above, whichever is lower.
 Overload Voltage= $2.5 \cdot \sqrt{P \cdot R}$ or Max. overload voltage listed above, whichever is lower.

Environmental Characteristics

Item	Requirement		Test Method
	Tol. $\leq 0.05\%$	TOL. $> 0.05\%$	
Temperature Coefficient of Resistance (TCR)	As per TCRs specified in Electrical Characteristics tables		MIL-STD-202 Method 304 +25/-55/+25/+125/+25°C
Short Time Overload	$\Delta R \pm 0.2\%$	$\Delta R \pm 0.2\%$	JIS-C-5201-1 5.5 RCWV*2.5 or Max. overload voltage whichever is lower for 5 seconds
Insulation Resistance	$> 1000 \text{ M}\Omega$		MIL-STD-202 Method 302 Apply 100VDC for 1 minute
Endurance	$\Delta R \pm 0.5\%$		MIL-STD-202 Method 108A 70 \pm 2°C, RCWV for 1000 hrs with 1.5 hrs "ON" and 0.5 hrs "OFF"
Damp Heat with Load	$\Delta R \pm 0.5\%$	$\Delta R \pm 0.5\%$	MIL-STD-202 Method 103B 40 \pm 2°C, 90~95% R.H. RCWV for 1000 hrs with 1.5 hrs "ON" and 0.5 hrs "OFF"
Bending Strength	$\Delta R \pm 0.05\%$	$\Delta R \pm 0.2\%$	JIS-C-5201-1 6.1.4 Bending amplitude 3 mm for 10 seconds
Solderability	95% min. coverage		MIL-STD-202 Method 208H 245 \pm 5°C for 3 seconds
Resistance to Soldering Heat	$\Delta R \pm 0.05\%$	$\Delta R \pm 0.2\%$	MIL-STD-202 Method 210E 260 \pm 5°C for 10 seconds
Dielectric Withstand Voltage	By Type		MIL-STD-202 Method 301 Max. overload voltage for 1 minute
Thermal Shock	$\Delta R \pm 0.05\%$	$\Delta R \pm 0.25\%$	MIL-STD-202 Method 107G -55°C ~ 150°C, 100 cycles
Low Temperature Operation	$\Delta R \pm 0.5\%$	$\Delta R \pm 0.5\%$	JIS-C-5201-1 7.1 1 hour, -65°C, followed by 45 minutes of RCWV

Storage Temperature: 25 \pm 3°C; Humidity < 80%RH

Derating Curve



For resistors operated in ambient temperatures above 70°C, power rating must be derated in accordance with this curve

Construction and dimensions



①	Alumina Substrate	④	Edge Electrode (NiCr)	⑦	Resistor Layer (NiCr)
②	Bottom Electrode (Ag)	⑤	Barrier Layer (Ni)	⑧	Overcoat (Epoxy)
③	Top Electrode (Ag)	⑥	External Electrode (Sn)	⑨	Marking

Size	L (mm)	W (mm)	T (mm)	D1 (mm)	D2 (mm)	Weight (g) (1000 Pcs.)
0402	1.00±0.05	0.50±0.05	0.30±0.05	0.20±0.10	0.20±0.10	0.54
0603	1.55±0.10	0.80±0.10	0.45±0.10	0.30±0.20	0.30±0.20	1.83
0805	2.00±0.15	1.25±0.15	0.55±0.10	0.30±0.20	0.40±0.20	4.71
1206	3.05±0.15	1.55±0.15	0.55±0.10	0.42±0.20	0.35±0.25	9.02
1210	3.10±0.15	2.40±0.15	0.55±0.10	0.40±0.20	0.55±0.25	10
2010	4.90±0.15	2.40±0.15	0.55±0.10	0.60±0.30	0.50±0.25	23.61
2512	6.30±0.15	3.10±0.15	0.55±0.10	0.60±0.30	0.50±0.25	38.06

Suggested PCB Layout Plan

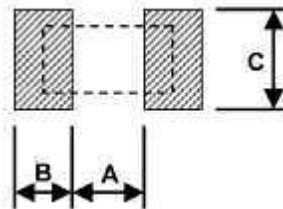

Recommended Land Pattern			
Size	A	B	C
0402	0.50	0.50	0.60±0.2
0603	0.80	1.00	0.90±0.2
0805	1.00	1.00	1.35±0.2
1206	2.00	1.15	1.70±0.2
1210	2.00	1.15	2.50±0.2
2010	3.60	1.40	2.50±0.2
2512	4.90	1.60	3.10±0.2

Marking

Case sizes 0805 to 2512 IEC 4 Digit Marking:

Resistance	100R (100Ω)	2K2 (2.2kΩ)	10K (10kΩ)	499K (499kΩ)	100K (100kΩ)
Code	1000	2201	1002	4992	1003

Case Size 0603 E24 3 digit marking – Example 101 = 100R 102=1K0

E24	10	11	12	13	15	16	18	20	22	24	27	30
	33	36	39	43	47	51	56	62	68	75	82	91

Case size 0603 E96 3 digit marking – Examples 14C = 13K7 68B = 4K99 68X = 49R9

Code	E96	Code	E96	Code	E96	Code	E96
01	100	25	178	49	316	73	562
02	102	26	182	50	324	74	576
03	105	27	187	51	332	75	590
04	107	28	191	52	340	76	604
05	110	29	196	53	348	77	619
06	113	30	200	54	357	78	634
07	115	31	205	55	365	79	649
08	118	32	210	56	374	80	665
09	121	33	215	57	383	81	681
10	124	34	221	58	392	82	698
11	127	35	226	59	402	83	715
12	130	36	232	60	412	84	732
13	133	37	237	61	422	85	750
14	137	38	243	62	432	86	768
15	140	39	249	63	442	87	787
16	143	40	255	64	453	88	806
17	147	41	261	65	464	89	825
18	150	42	267	66	475	90	845
19	154	43	274	67	487	91	866
20	158	44	280	68	499	92	887
21	162	45	287	69	511	93	909
22	165	46	294	70	523	94	931
23	169	47	301	71	536	95	953
24	174	48	309	72	549	96	976

Code	A	B	C	D	E	F	G	H	X	Y	Z
Multiplier	10 ⁰	10 ¹	10 ²	10 ³	10 ⁴	10 ⁵	10 ⁶	10 ⁷	10 ⁻¹	10 ⁻²	10 ⁻³

NB for 0603 size values other than E24 and E96 will be supplied unmarked

Case sizes smaller than 0603 will be supplied unmarked

Packaging

Packing Quantity and Reel Specification



Size	$\varnothing A \pm 1.0$	$\varnothing B \pm 1.0$	$\varnothing C \pm 0.7$	$W \pm 1.0$	$T \pm 1.0$	Paper Tape	Embossed Plastic Tape
0402	178.0	60.0	13.5	9.5	11.5	1000 / 5000	N/A
0603							
0805							
1206				13.5	15.5	N/A	4000
1210							
2010							
2512							

Paper tape Specification

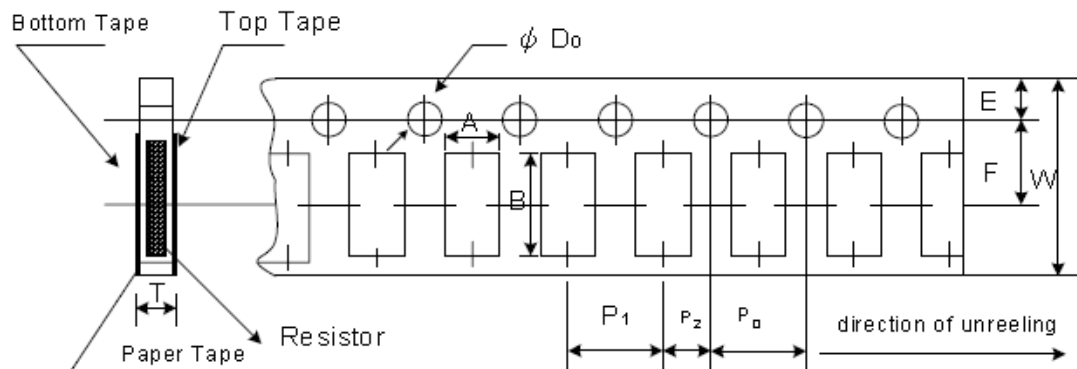

Size	$A \pm 0.05$	$B \pm 0.05$	$W \pm 0.10$	$E \pm 0.05$	$F \pm 0.05$	P_0	P_1	$P_2 \pm 0.05$	$\varnothing D_0$	T	
0402	0.70	1.16	8.00	1.75	3.5	4.00 ± 0.10	2.00 ± 0.05	2.00	1.55 ± 0.05	0.40 ± 0.03	
0603	1.10	1.90					4.00 ± 0.10			4.00 ± 0.10	0.60 ± 0.03
0805	1.60	2.37					4.00 ± 0.05				0.75 ± 0.05
1206	2.00	3.55				1.60 ± 0.10					
1210	2.75	3.40									

Peel force of top cover tape

The peel speed shall be about 300mm/min±5%

The peel force of top cover tape shall be between 8gf to 60gf



Embossed Plastic Tape Specifications



Type	A	B	W	E	F	P ₀	P ₁	P ₂	ØD ₀	T
2010	2.85±0.10	5.45±0.10	12.0±0.10	1.75±0.10	5.5±0.05	4.00±0.05	4.00±0.10	2.00±0.05	1.50±0.10	1.00±0.20
2512	3.40±0.10	6.65±0.10	12.0±0.10	1.75±0.10	5.5±0.05	4.00±0.05	4.00±0.10	2.00±0.05	1.50±0.10	1.00±0.20

Peel force of top cover tape

The peel speed shall be about 300mm/min±5%

The peel force of top cover tape shall be between 20gf to 80gf



Reflow Solder Profile



Time of Reflow soldering at maximum temperature point 260°C = 10s

Wave Solder Profile



Time of Wave soldering at maximum temperature point 260°C = 10s

Time of Soldering Iron at maximum temperature point 410°C = 5s

How To Order

RP73	C	2A	100R	B	TD
Common Part	TCR	Package Size	Value	Tolerance	Packaging
RP73 – Standard	A - ±5ppm/°C	1E - 0402	100R (100Ω)	A - ±0.05%	TG – 250 cut tape length (1E, 1J, 2A, 2B)
RP73P – High Power	C - ±10ppm/°C	1J – 0603	1K0 (1000Ω)	B - ±0.1%	TDF – 1000 reel (1E, 1J, 2A, 2B)
	D - ±15PPM	2A – 0805	100K (100,000 Ω)	D - ±0.5%	TD – 5000 reel (1E, 1J, 2A, 2B, 2E)
	F - ±25PPM	2B – 1206		F - ±1.0%	TE – 4000 reel (2H, 3A only)
	G - ±50PPM	2E – 1210			
		2H – 2010			
		3A - 2512			

Mouser Electronics

Authorized Distributor

Click to View Pricing, Inventory, Delivery & Lifecycle Information:

[TE Connectivity:](#)

[RP73D2B499RBTG](#)