

THIS DRAWING IS UNPUBLISHED. RELEASED FOR PUBLICATION  
 © COPYRIGHT - REVISED PER ECO-11-004587 ALL RIGHTS RESERVED.

LOC	DIST	REVISIONS					
AD	00	P	LTR	DESCRIPTION	DATE	DWN	APVD
		P1		REVISED PER ECO-11-004587	11MAR11	RK	HMR

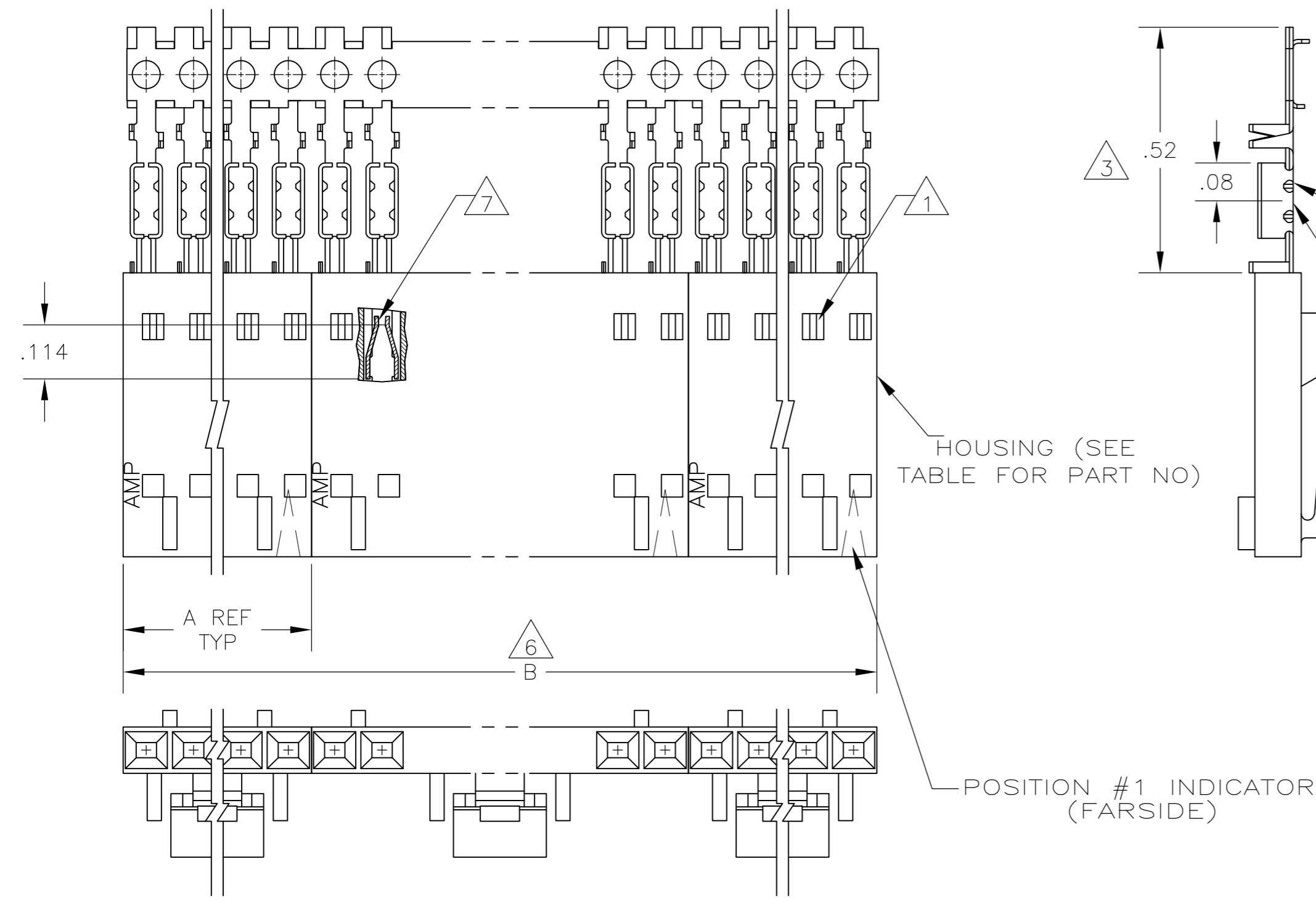

CONTACT IDENTIFICATION LETTER "B" (LOCATED IN THIS AREA)

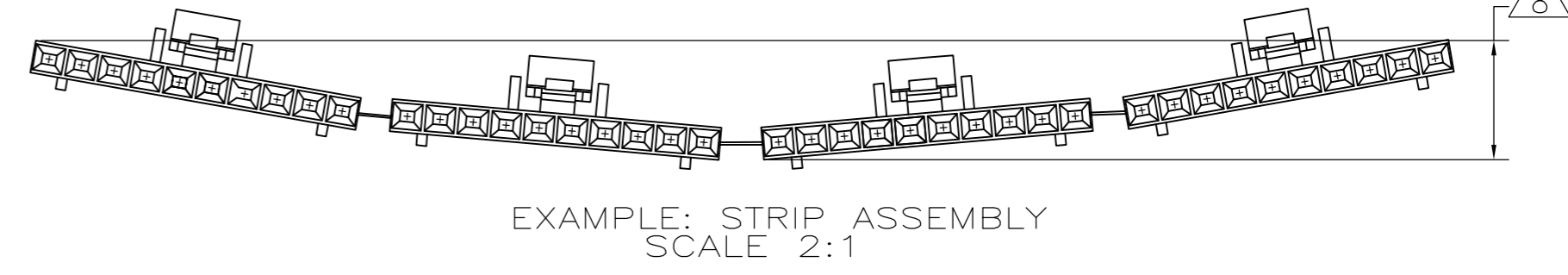

12	2	2.40	1.198	1-104257-1	12	6-103956-1
12	2	2.20	1.098	1-104257-0	11	6-103956-0
12	2	2.00	.998	104257-9	10	5-103956-9
12	2	1.80	.898	104257-8	9	5-103956-8
12	2	1.60	.798	104257-7	8	5-103956-7
12	2	1.40	.698	104257-6	7	5-103956-6
12	4	2.39	.598	104257-5	6	5-103956-5
12	4	1.99	.498	104257-4	5	5-103956-4
12	5	1.99	.398	104257-3	4	5-103956-3
12	8	2.40	.298	104257-2	3	5-103956-2
12	10	2.00	.198	104257-1	2	5-103956-1
11	10	2	1.40	104257-6	7	1-103956-8
11	10	2	1.60	104257-7	8	1-103956-7
11	10	4	2.39	104257-5	6	1-103956-6
11	10	4	1.99	104257-4	5	1-103956-5
11	10	5	1.99	104257-3	4	1-103956-4
11	10	8	2.40	104257-2	3	1-103956-3
11	10	10	2.00	104257-1	2	1-103956-2
9	2	2.40	1.198	1-104257-1	12	1-103956-1
9	2	2.20	1.098	1-104257-0	11	1-103956-0
9	2	2.00	.998	104257-9	10	103956-9
9	2	1.80	.898	104257-8	9	103956-8
9	2	1.60	.798	104257-7	8	103956-7
9	2	1.40	.698	104257-6	7	103956-6
9	4	2.39	.598	104257-5	6	103956-5
9	4	1.99	.498	104257-4	5	103956-4
9	5	1.99	.398	104257-3	4	103956-3
9	8	2.40	.298	104257-2	3	103956-2
9	10	2.00	.198	104257-1	2	103956-1
PLATING	6	B	A	HOUSING PART NUMBER	NO OF POSN	ASSEMBLY PART NUMBER ON STRIP

- 1 CONTACTS ARE LATCHED INTO THE PRELOAD WINDOWS.
- 2 USE WITH #22-#26 AWG WIRE SIZE, .054/.030 INSULATION DIAMETER, .015 MAXIMUM INSULATION THICKNESS.
- 3 THE DIMENSION APPLIES WITH THE FORWARD PRELOAD STOP IN CONTACT WITH THE HOUSING SURFACE.
- 4 POINT OF MEASUREMENT FOR PLATING THICKNESS.
- 5 FOR INDIVIDUAL ASSEMBLIES SEE PART NUMBER 103645.
- 6 ASSEMBLIES ARE JOINED BY THE CARRIER STRIP. ORDER QUANTITY REFLECTS TOTAL NUMBER OF INDIVIDUAL ASSEMBLIES REQUIRED. SEE TABLE FOR NUMBER OF ASSEMBLIES PER STRIP.
- 7 POINT OF MEASUREMENT FOR PLATING THICKNESS (INSIDE BEAMS)
- 8 MAXIMUM ALLOWABLE BOW OF ASSEMBLY NOT TO EXCEED .055.
- 9 .000100-.000200 BRIGHT TIN-LEAD OVER .000050 NICKEL.
- 10 .000100-.000200 BRIGHT TIN OVER .000050 NICKEL.
- 11 PRELIMINARY PART - NOT RELEASED FOR PRODUCTION.
- 12 .000100-.000200 MATTE TIN OVER .000050 NICKEL.

THIS DRAWING IS A CONTROLLED DOCUMENT.

DWN L A MAYER 11-4-86  
 CHK P de Jong 11-12-86  
 APVD P de Jong 11-12-86

TE Connectivity

RCPT ASSY, AMPMODU MTE, SINGLE ROW, .100 C/L, LATCHED & POLARIZED, FOR #22-#26 AWG WIRE SIZE, STRIP FORM

108-25034  
 114-25026

SIZE A2 CAGE CODE 00779 C=103956 DRAWING NO RESTRICTED TO

WEIGHT - SCALE 4:1 SHEET 1 of 1 REV P1

CUSTOMER DRAWING

# Mouser Electronics

Authorized Distributor

Click to View Pricing, Inventory, Delivery & Lifecycle Information:

[TE Connectivity:](#)

[5-103956-5](#)