

SF1092A

**199 MHz
SAW Filter**

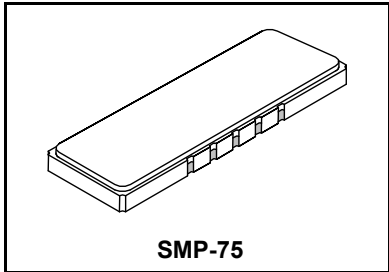

- *Designed for GSM BTS Receiver IF Applications*
- *Low Insertion Loss*
- *Excellent Size-to-Performance Ratio*
- *Hermetic SMP-75 Surface-Mount Case*
- *Unbalanced Input and Output*
- *Complies with Directive 2002/95/EC (RoHS)*



Absolute Maximum Ratings

Rating	Value	Units
Maximum Incident Power in Passband	+18	dBm
Maximum DC voltage between any 2 terminals	30	VDC
Storage Temperature Range	-40 to +85	°C
Suitable for lead-free soldering - Maximum Soldering Profile	260°C for 30 s	

Electrical Specifications

Characteristic	Sym	Notes	Min	Typ	Max	Units	
Nominal Center Frequency	f_c	1	199.000			MHz	
Passband Insertion Loss at f_c 1 dB Passband Amplitude Ripple over $f_c \pm 100$ kHz Group Delay Variation over $f_c \pm 100$ kHz	IL	1, 2		5.5	7.0	dB	
	BW_1		± 100	± 140		kHz	
					1.0		dB _{P-P}
	GDV			300	500		ns _{P-P}
Rejection $f_c - 800$ to $f_c - 600$ and $f_c + 600$ to $f_c + 800$ kHz 119 MHz to $f_c - 800$ kHz $f_c + 800$ kHz to 278 MHz		1, 2, 3	35			dB	
			45				
			45				
Operating Temperature Range	T_A	1	-10		+85	°C	
Frequency Temperature Coefficient	FTC	1		0.32		ppm/°C ²	

Impedance Matching to 50 Ω unbalanced	External L-C
Case Style	SMP-75 19 x 6.5 mm Nominal Footprint
Lid Symbolization (YY = year, WW = week)	RFM SF1092A YYWW

CAUTION: Electrostatic Sensitive Device. Observe precautions for handling.

NOTES:

1. Unless noted otherwise, all specifications apply over the operating temperature range with filter soldered to the specified demonstration board with impedance matching to 50 Ω and measured with 50 Ω network analyzer.
2. Unless noted otherwise, all frequency specifications are referenced to the nominal center frequency, f_c .
3. Rejection is measured as attenuation below the minimum IL point in the passband. Rejection in final user application is dependent on PCB layout and external impedance matching design. See Application Note No. 42 for details.
4. The turnover temperature, T_O , is the temperature of maximum (or turnover) frequency, f_o . The nominal frequency at any case temperature, T_c , may be calculated from: $f = f_o [1 - FTC(T_o - T_c)^2]$.
5. The design, manufacturing process, and specifications of this filter are subject to change.
6. Either Port 1 or Port 2 may be used for either input or output in the design. However, impedances and impedance matching may vary between Port 1 and Port 2, so that the filter must always be installed in one direction per the circuit design.
7. US and international patents may apply.

SF1092A Demo Board

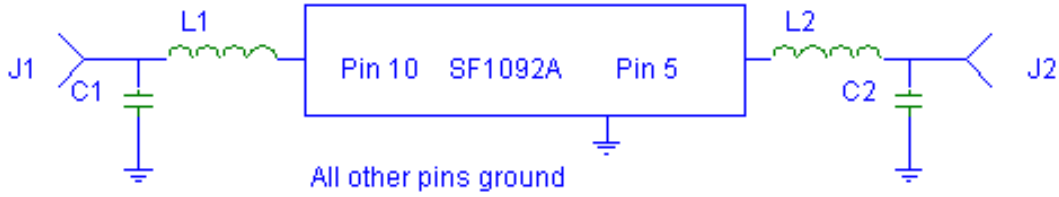

PCB=400-1467-001 19 mm demo
 J1, J2=500-0248-001 4 hole flange SMA connector
 C1, C2=500 0003 220 22pF
 L1=500 0782 820 0805CS 82 nH
 L2=500-0782-680 0805CS 68 nH
 Note: L1 and L2 are at 90 degree angle to each other

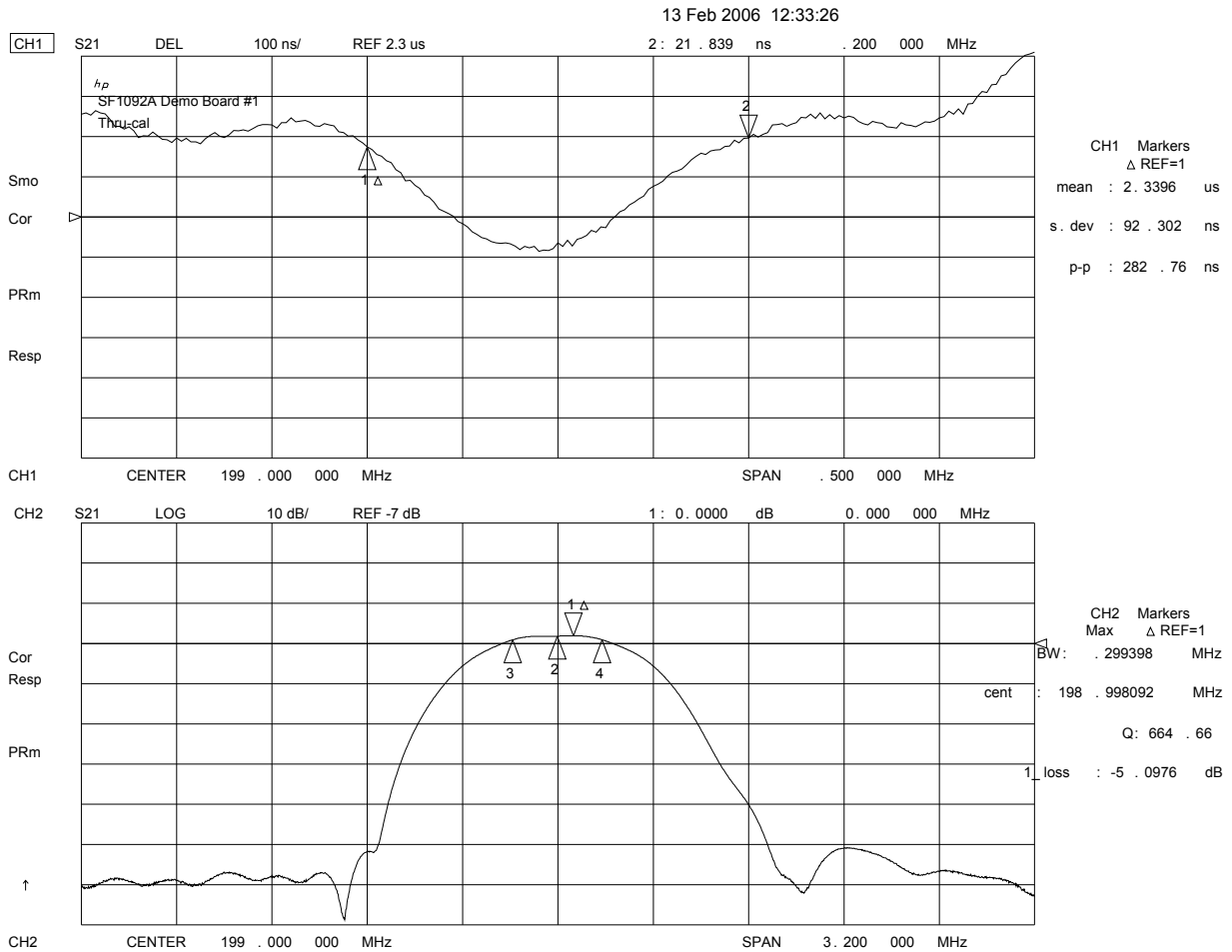

13 Feb 2006 12:34:35

CH1 S11 1 UFS

1: 27.100 Ω 26.697 Ω 21.352 nH 199.000 000 MHz

hp
SF1092A Demo Board #1
Full 2-port cal

Cor

PRm

Full

↑

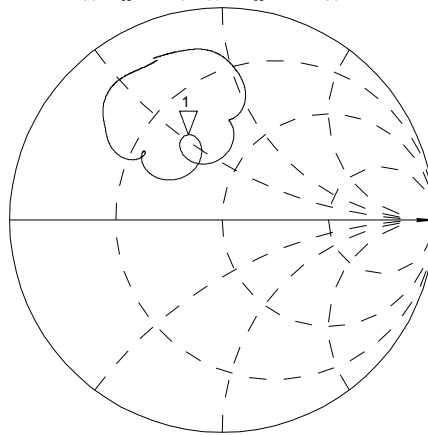

CH2 S22 1 UFS

1: 36.609 Ω 31.684 Ω 25.340 nH 199.000 000 MHz

Cor

Full

PRm

↑

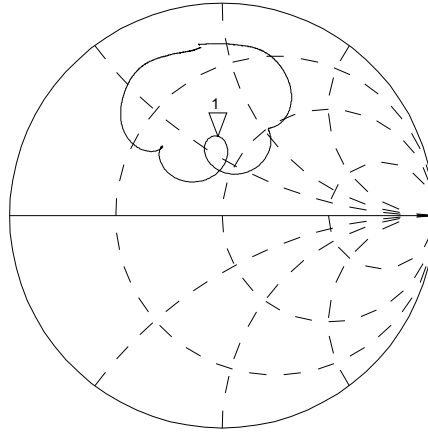

CENTER 199.000 000 MHz

SPAN 3.200 000 MHz

SMP-75 Case

10-Terminal Ceramic Surface-Mount Case 19 x 6.5 mm Nominal Footprint

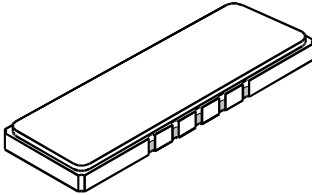

Case Dimensions						
Dimension	mm			Inches		
	Min	Nom	Max	Min	Nom	Max
A	18.80	19.00	19.30	0.740	0.748	0.760
B	6.30	6.50	6.80	0.248	0.256	0.268
C		1.75	2.00		0.069	0.079
D		2.29			0.090	
E		1.02			0.040	
H		1.0			0.039	
P		1.905			0.075	

Materials	
Solder Pad Termination	Au plating 30 - 60 μ inches (76.2-152 μ m) over 80-200 μ inches (203-508 μ m) Ni.
Lid	Fe-Ni-Co Alloy Electroless Nickel Plate (8-11% Phosphorus) 100-200 μ inches Thick
Body	Al ₂ O ₃ Ceramic
Pb Free	

Electrical Connections		
Connection		Terminals
Port 1	Input or Return	10
	Return or Input	1
Port 2	Output or Return	5
	Return or Output	6
Ground		All others
Single Ended Operation		Return is ground
Differential Operation		Return is hot

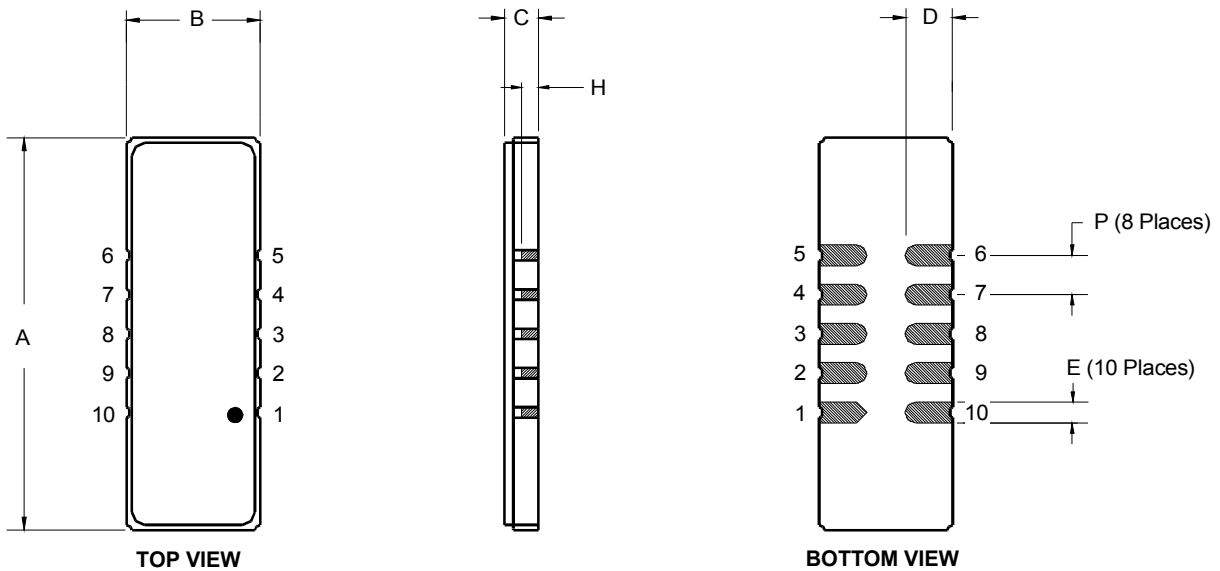

SMP-75 Pad Layout

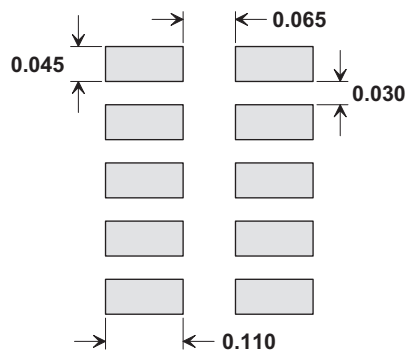

Dimensions are in inches
 All pads have same dimensions
 Vertical spacing between pads is 0.030"

COMPONENT ORIENTATION AND DIMENSIONS

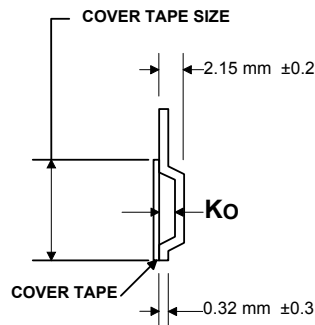
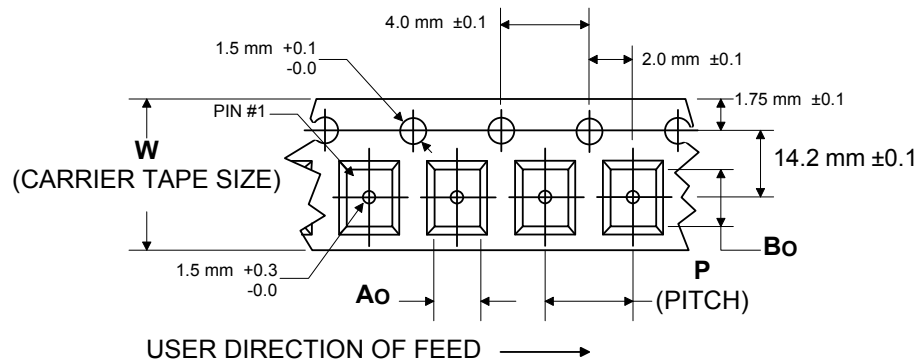

Carrier Tape Dimensions		
Ao	7.2 mm	± 0.1
Bo	19.51 mm	± 0.1
Ko	2.24 mm	± 0.1
Pitch	12.0 mm	± 0.1
W	32.0 mm	± 0.3