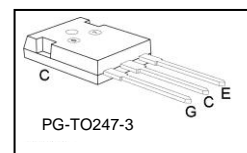
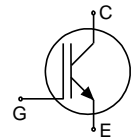


Low Loss IGBT : IGBT in TRENCHSTOP™ and Fieldstop technology



**Features:**

- Very low  $V_{CE(sat)}$  1.5V (typ.)
- Maximum Junction Temperature 175°C
- Short circuit withstand time 5μs
- Designed for :
  - Frequency Converters
  - Uninterrupted Power Supply
- TRENCHSTOP™ and Fieldstop technology for 600V applications offers :
  - very tight parameter distribution
  - high ruggedness, temperature stable behavior
  - very high switching speed
  - low  $V_{CE(sat)}$
- Positive temperature coefficient in  $V_{CE(sat)}$
- Low EMI
- Low Gate Charge
- Qualified according to JEDEC<sup>1</sup> for target applications
- Pb-free lead plating; RoHS compliant
- Complete product spectrum and PSpice Models : <http://www.infineon.com/igbt/>



| Type      | $V_{CE}$ | $I_C$ | $V_{CE(sat), T_j=25^\circ C}$ | $T_{j,max}$ | Marking | Package    |
|-----------|----------|-------|-------------------------------|-------------|---------|------------|
| IGW50N60T | 600 V    | 50 A  | 1.5 V                         | 175 °C      | G50T60  | PG-TO247-3 |

**Maximum Ratings**

| Parameter   | Symbol       | Value      | Unit |
|---|--------------|------------|------|
| Collector-emitter voltage, $T_j \geq 25^\circ C$  | $V_{CE}$     | 600        | V    |
| DC collector current, limited by $T_{j,max}$<br>$T_C = 25^\circ C$ , value limited by bondwire<br>$T_C = 100^\circ C$ | $I_C$        | 90<br>64   | A    |
| Pulsed collector current, $t_p$ limited by $T_{j,max}$  | $I_{C,puls}$ | 150        |      |
| Turn off safe operating area, $V_{CE} = 600V$ , $T_j = 175^\circ C$ , $t_p = 1\mu s$                                  | -            | 150        |      |
| Gate-emitter voltage  | $V_{GE}$     | $\pm 20$   | V    |
| Short circuit withstand time <sup>2)</sup><br>$V_{GE} = 15V$ , $V_{CC} \leq 400V$ , $T_j \leq 150^\circ C$            | $t_{SC}$     | 5          | μs   |
| Power dissipation $T_C = 25^\circ C$  | $P_{tot}$    | 333        | W    |
| Operating junction temperature  | $T_j$        | -40...+175 |      |
| Storage temperature   | $T_{stg}$    | -55...+150 | °C   |
| Soldering temperature, 1.6mm (0.063 in.) from case for 10s  | -            | 260        |      |

<sup>1</sup> J-STD-020 and JESD-022

<sup>2)</sup> Allowed number of short circuits: <1000; time between short circuits: >1s.

### Thermal Resistance

| Parameter                                | Symbol     | Conditions | Max. Value | Unit |
|--|------------|------------|------------|------|
| <b>Characteristic</b>                    |            |            |            |      |
| IGBT thermal resistance, junction – case | $R_{thJC}$ |            | 0.45       | K/W  |
| Thermal resistance, junction – ambient   | $R_{thJA}$ |            | 40         |      |

### Electrical Characteristic, at $T_j = 25\text{ °C}$ , unless otherwise specified

| Parameter                            | Symbol        | Conditions                 | Value               |      |      | Unit     |         |
|--------------------------------------|---------------|----------------------------|---------------------|------|------|----------|---------|
|                                      |               |                            | min.                | Typ. | max. |          |         |
| <b>Static Characteristic</b>         |               |                            |                     |      |      |          |         |
| Collector-emitter breakdown voltage  | $V_{(BR)CES}$ | $V_{GE}=0V, I_C=0.2mA$     | 600                 | -    | -    | V        |         |
| Collector-emitter saturation voltage | $V_{CE(sat)}$ | $V_{GE} = 15V, I_C=50A$    | -                   | 1.5  | 2.0  |          |         |
|                                      |               | $T_j=25\text{ °C}$         | -                   | 1.9  | -    |          |         |
| Gate-emitter threshold voltage       | $V_{GE(th)}$  | $I_C=0.8mA, V_{CE}=V_{GE}$ | 4.1                 | 4.9  | 5.7  |          |         |
| Zero gate voltage collector current  | $I_{CES}$     | $V_{CE}=600V, V_{GE}=0V$   | $T_j=25\text{ °C}$  | -    | -    | 40       | $\mu A$ |
|                                      |               |                            | $T_j=175\text{ °C}$ | -    | -    | 3500     |         |
| Gate-emitter leakage current         | $I_{GES}$     | $V_{CE}=0V, V_{GE}=20V$    | -                   | -    | 100  | nA       |         |
| Transconductance                     | $g_{fs}$      | $V_{CE}=20V, I_C=50A$      | -                   | 31   | -    | S        |         |
| Integrated gate resistor             | $R_{Gint}$    |                            | -                   |      |      | $\Omega$ |         |

### Dynamic Characteristic

|  |             |   |   |       |   |         |
|--|-------------|---|---|-------|---|---------|
| Input capacitance  | $C_{iss}$   | $V_{CE}=25V, V_{GE}=0V, f=1MHz$                                     | - | 3140  | - | $\mu F$ |
| Output capacitance   | $C_{oss}$   |   | - | 200   | - |         |
| Reverse transfer capacitance                                   | $C_{rss}$   |   | - | 93    | - |         |
| Gate charge  | $Q_{Gate}$  | $V_{CC}=480V, I_C=50A, V_{GE}=15V$                                  | - | 310   | - | nC      |
| Internal emitter inductance measured 5mm (0.197 in.) from case | $L_E$       | PG-TO-220-3-1   | - | 7     | - | nH      |
|  |             | PG-TO-247-3-21  | - | 13    | - |         |
| Short circuit collector current <sup>1)</sup>                  | $I_{C(SC)}$ | $V_{GE}=15V, t_{SC}\leq 5\mu s, V_{CC}=400V, T_j\leq 150\text{ °C}$ | - | 458.3 | - | A       |

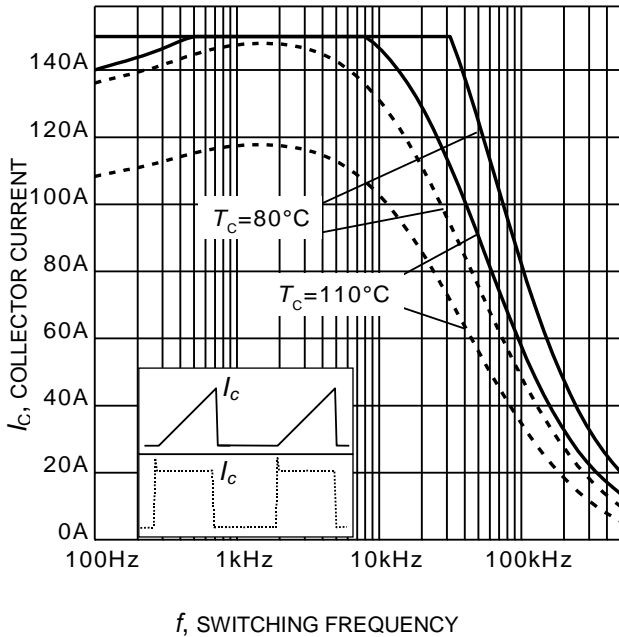
<sup>1)</sup> Allowed number of short circuits: <1000; time between short circuits: >1s.

### Switching Characteristic, Inductive Load, at $T_j=25\text{ °C}$

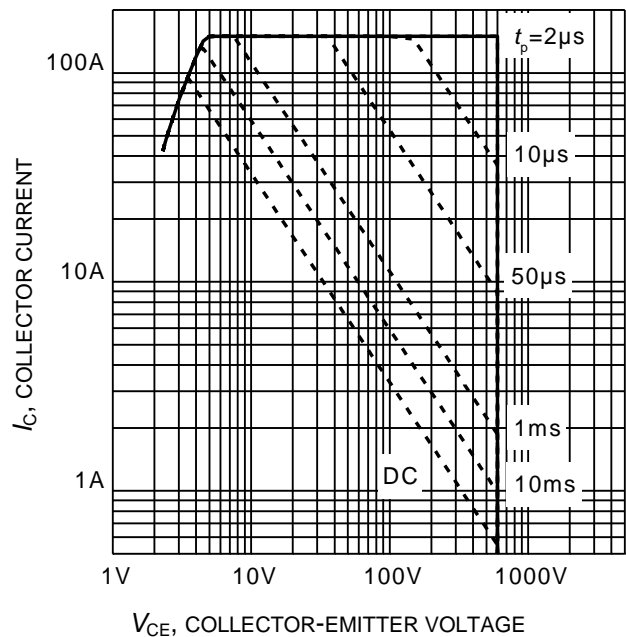
| Parameter                  | Symbol       | Conditions  | Value |      |      | Unit |
|----------------------------|--------------|---|-------|------|------|------|
|                            |              |   | min.  | Typ. | max. |      |
| <b>IGBT Characteristic</b> |              |   |       |      |      |      |
| Turn-on delay time         | $t_{d(on)}$  | $T_j=25\text{ °C}$ ,<br>$V_{CC}=400\text{V}$ , $I_C=50\text{A}$ ,<br>$V_{GE}=0/15\text{V}$ , $r_G=7\Omega$ ,<br>$L_\sigma=103\text{nH}$ , $C_\sigma=39\text{pF}$<br>$L_\sigma$ , $C_\sigma$ from Fig. E<br>Energy losses include<br>"tail" and diode reverse<br>recovery.<br>Diode from IKW50N60T | -     | 26   | -    | ns   |
| Rise time                  | $t_r$        |   | -     | 29   | -    |      |
| Turn-off delay time        | $t_{d(off)}$ |   | -     | 299  | -    |      |
| Fall time                  | $t_f$        |   | -     | 29   | -    |      |
| Turn-on energy             | $E_{on}$     | Diode from IKW50N60T  | -     | 1.2  | -    | mJ   |
| Turn-off energy            | $E_{off}$    |   | -     | 1.4  | -    |      |
| Total switching energy     | $E_{ts}$     |   | -     | 2.6  | -    |      |

### Switching Characteristic, Inductive Load, at $T_j=150\text{ °C}$

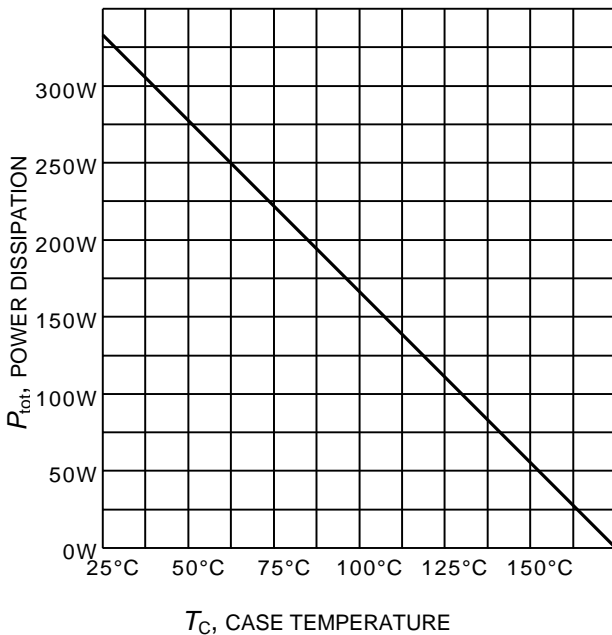
| Parameter                  | Symbol       | Conditions   | Value |      |      | Unit |
|----------------------------|--------------|--|-------|------|------|------|
|                            |              |  | min.  | Typ. | max. |      |
| <b>IGBT Characteristic</b> |              |  |       |      |      |      |
| Turn-on delay time         | $t_{d(on)}$  | $T_j=175\text{ °C}$ ,<br>$V_{CC}=400\text{V}$ , $I_C=50\text{A}$ ,<br>$V_{GE}=0/15\text{V}$ , $r_G=7\Omega$ ,<br>$L_\sigma=103\text{nH}$ , $C_\sigma=39\text{pF}$<br>$L_\sigma$ , $C_\sigma$ from Fig. E<br>Energy losses include<br>"tail" and diode reverse<br>recovery.<br>Diode from IKW50N60T | -     | 27   | -    | ns   |
| Rise time                  | $t_r$        |  | -     | 33   | -    |      |
| Turn-off delay time        | $t_{d(off)}$ |  | -     | 341  | -    |      |
| Fall time                  | $t_f$        |  | -     | 55   | -    |      |
| Turn-on energy             | $E_{on}$     | Diode from IKW50N60T   | -     | 1.8  | -    | mJ   |
| Turn-off energy            | $E_{off}$    |  | -     | 1.8  | -    |      |
| Total switching energy     | $E_{ts}$     |  | -     | 3.6  | -    |      |



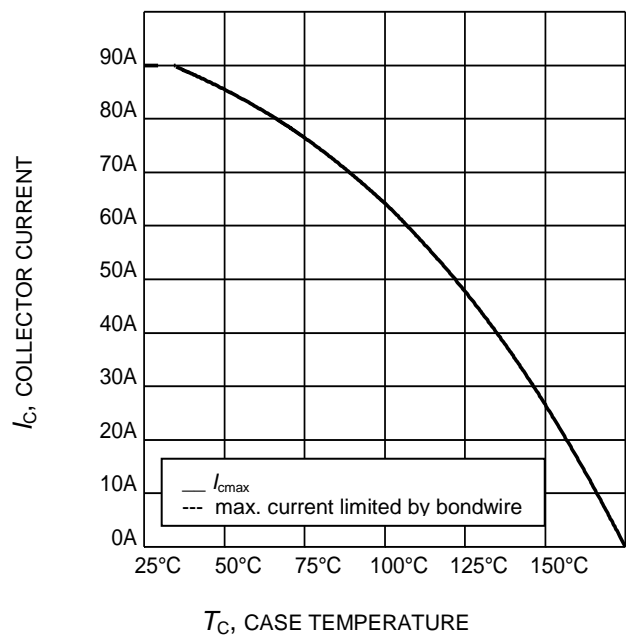
**Figure 1. Collector current as a function of switching frequency**  
( $T_j \leq 175^\circ\text{C}$ ,  $D = 0.5$ ,  $V_{CE} = 400\text{V}$ ,  $V_{GE} = 0/15\text{V}$ ,  $r_G = 7\Omega$ )



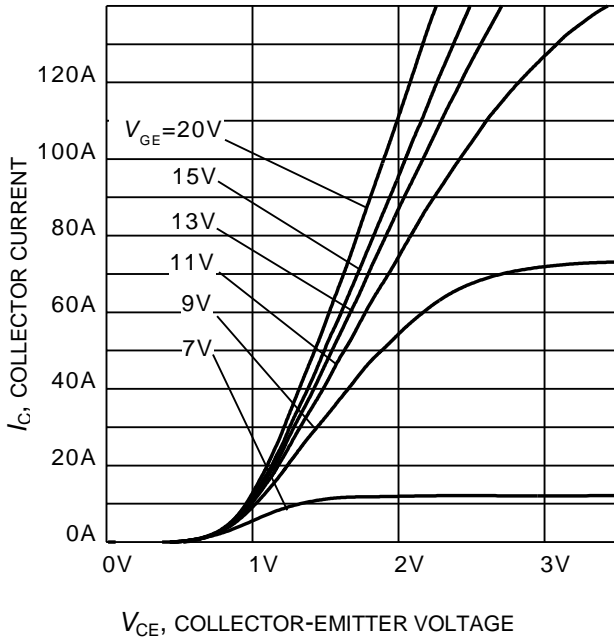
**Figure 2. Safe operating area**  
( $D = 0$ ,  $T_C = 25^\circ\text{C}$ ,  $T_j \leq 175^\circ\text{C}$ ;  $V_{GE} = 0/15\text{V}$ )



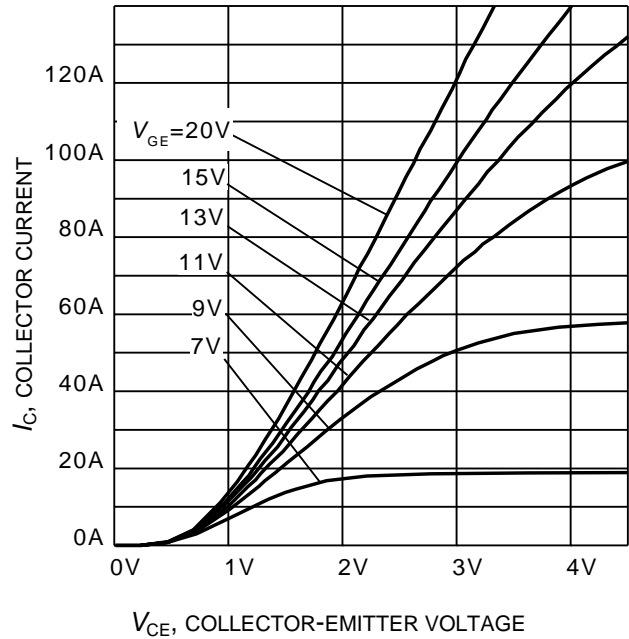
**Figure 3. Power dissipation as a function of case temperature**  
( $T_j \leq 175^\circ\text{C}$ )



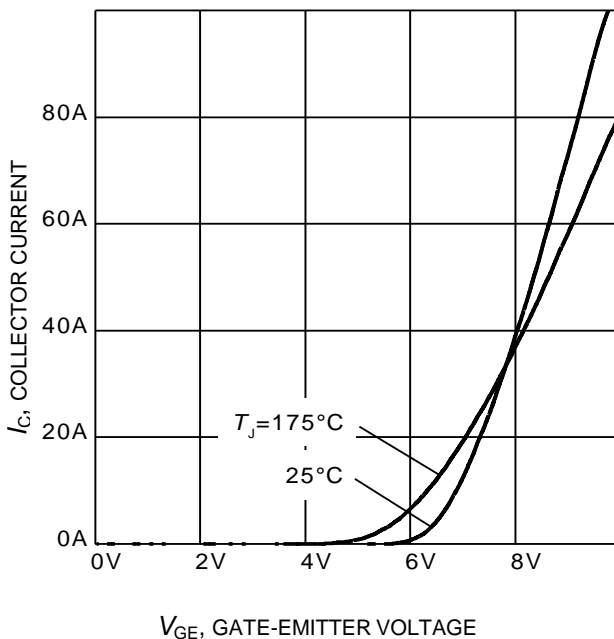
**Figure 4. Collector current as a function of case temperature**  
( $V_{GE} \geq 15\text{V}$ ,  $T_j \leq 175^\circ\text{C}$ )



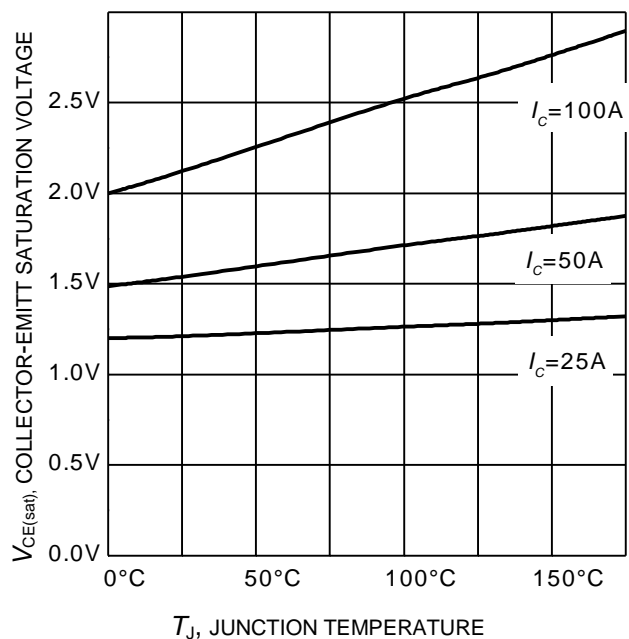
**Figure 5. Typical output characteristic**  
( $T_j = 25^\circ\text{C}$ )



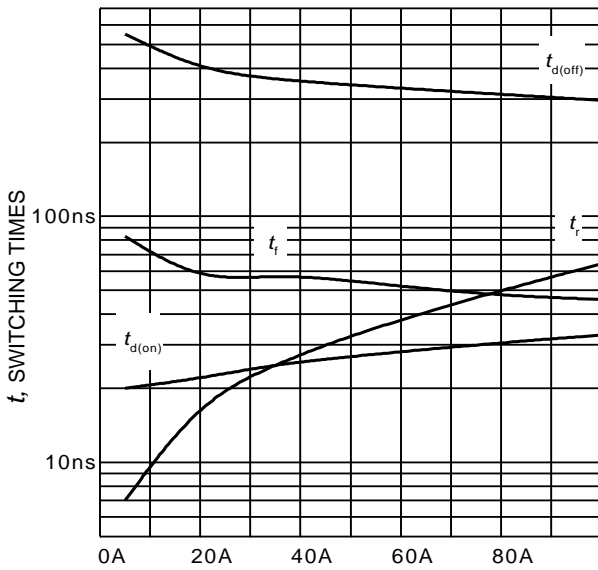
**Figure 6. Typical output characteristic**  
( $T_j = 175^\circ\text{C}$ )



**Figure 7. Typical transfer characteristic**  
( $V_{CE} = 20\text{V}$ )

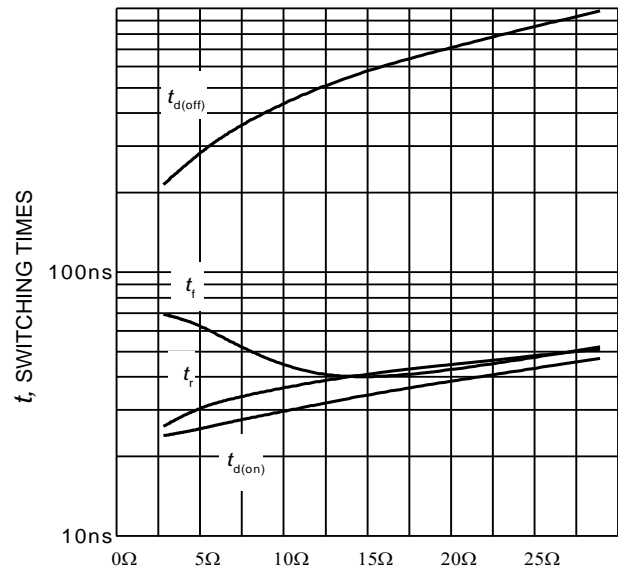


**Figure 8. Typical collector-emitter saturation voltage as a function of junction temperature**  
( $V_{GE} = 15\text{V}$ )



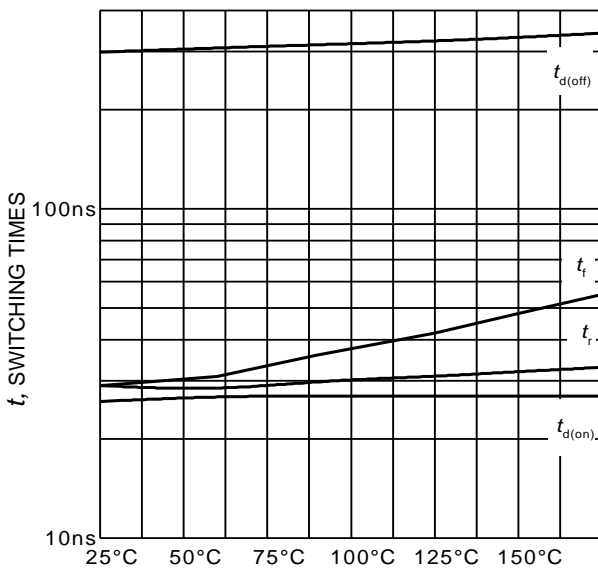
$I_C$ , COLLECTOR CURRENT

**Figure 9. Typical switching times as a function of collector current**  
(inductive load,  $T_J=175^\circ\text{C}$ ,  
 $V_{CE} = 400\text{V}$ ,  $V_{GE} = 0/15\text{V}$ ,  $r_G = 7\Omega$ ,  
Dynamic test circuit in Figure E)



$R_G$ , GATE RESISTOR

**Figure 10. Typical switching times as a function of gate resistor**  
(inductive load,  $T_J = 175^\circ\text{C}$ ,  
 $V_{CE} = 400\text{V}$ ,  $V_{GE} = 0/15\text{V}$ ,  $I_C = 50\text{A}$ ,  
Dynamic test circuit in Figure E)



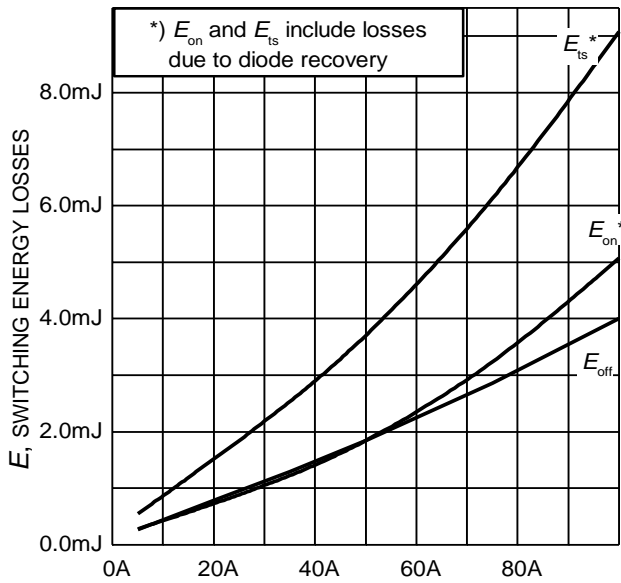
$T_J$ , JUNCTION TEMPERATURE

**Figure 11. Typical switching times as a function of junction temperature**  
(inductive load,  $V_{CE} = 400\text{V}$ ,  
 $V_{GE} = 0/15\text{V}$ ,  $I_C = 50\text{A}$ ,  $r_G=7\Omega$ ,  
Dynamic test circuit in Figure E)



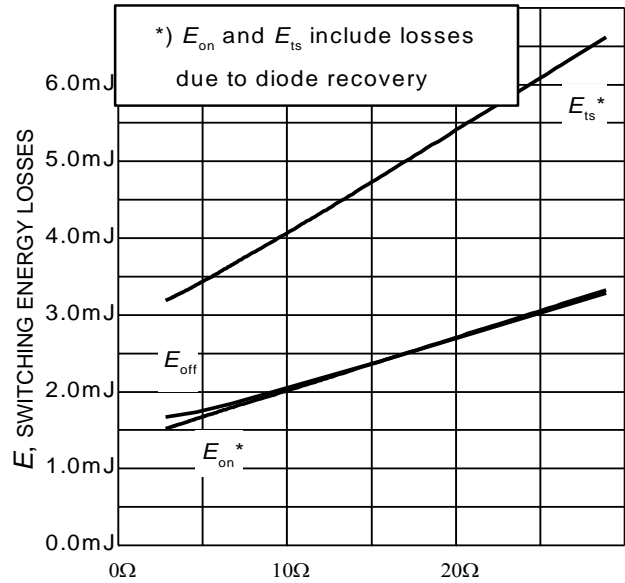
$T_J$ , JUNCTION TEMPERATURE

**Figure 12. Gate-emitter threshold voltage as a function of junction temperature**  
( $I_C = 0.8\text{mA}$ )



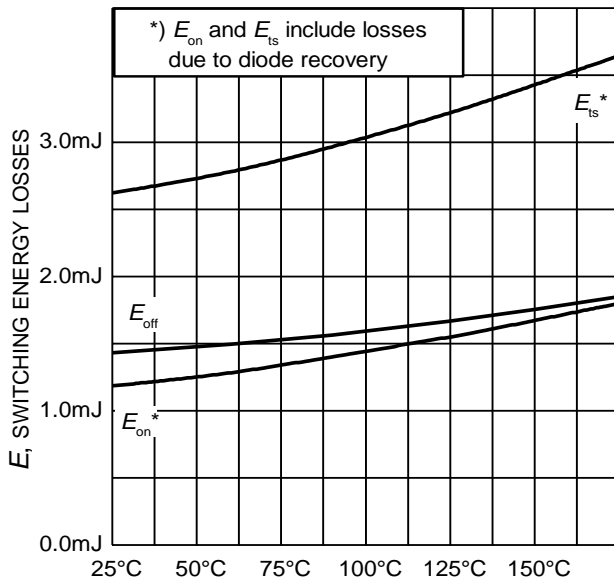
$I_C$ , COLLECTOR CURRENT

**Figure 13. Typical switching energy losses as a function of collector current**  
(inductive load,  $T_J = 175^\circ\text{C}$ ,  $V_{CE} = 400\text{V}$ ,  $V_{GE} = 0/15\text{V}$ ,  $r_G = 7\Omega$ , Dynamic test circuit in Figure E)



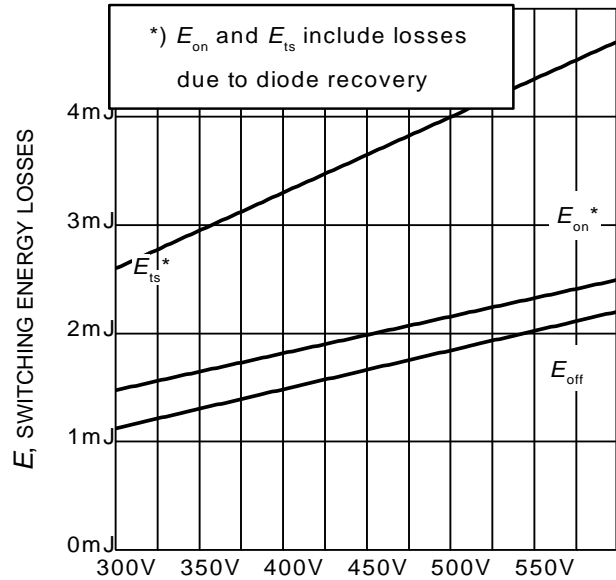
$R_G$ , GATE RESISTOR

**Figure 14. Typical switching energy losses as a function of gate resistor**  
(inductive load,  $T_J = 175^\circ\text{C}$ ,  $V_{CE} = 400\text{V}$ ,  $V_{GE} = 0/15\text{V}$ ,  $I_C = 50\text{A}$ , Dynamic test circuit in Figure E)



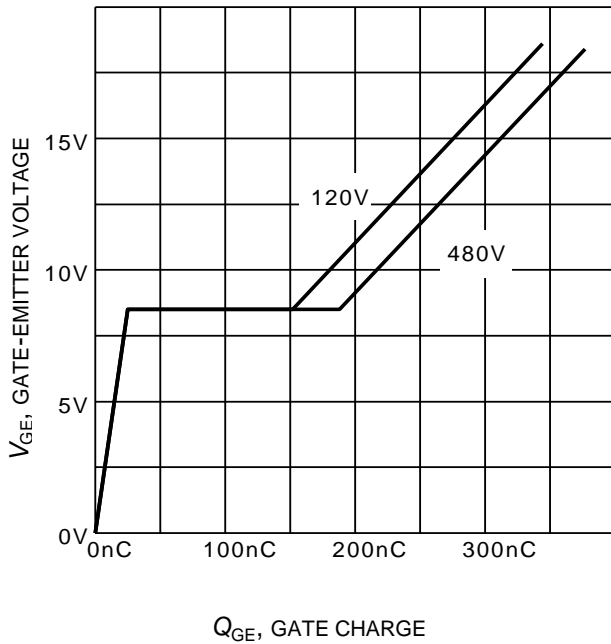
$T_J$ , JUNCTION TEMPERATURE

**Figure 15. Typical switching energy losses as a function of junction temperature**  
(inductive load,  $V_{CE} = 400\text{V}$ ,  $V_{GE} = 0/15\text{V}$ ,  $I_C = 50\text{A}$ ,  $r_G = 7\Omega$ , Dynamic test circuit in Figure E)

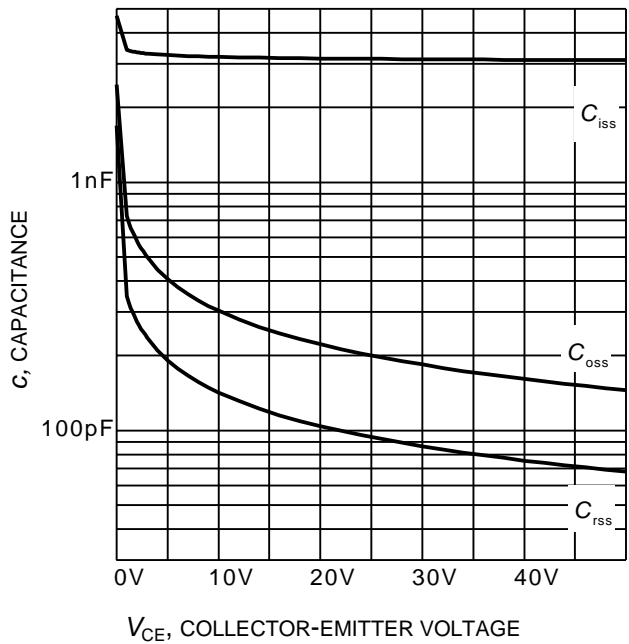


$V_{CE}$ , COLLECTOR-EMITTER VOLTAGE

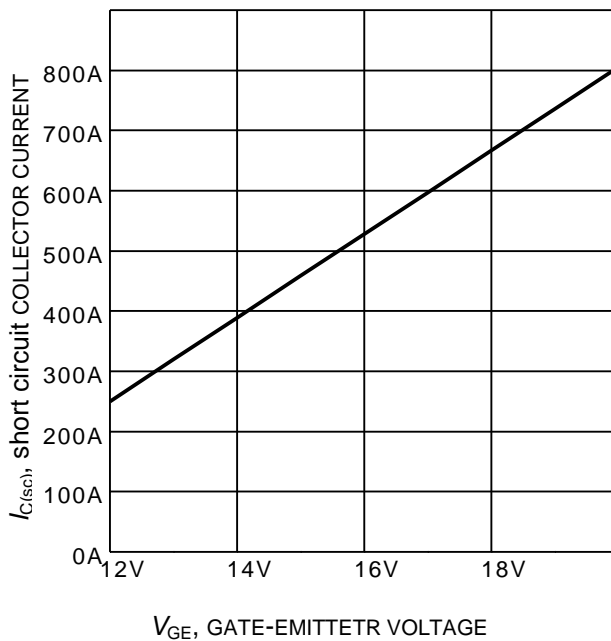
**Figure 16. Typical switching energy losses as a function of collector emitter voltage**  
(inductive load,  $T_J = 175^\circ\text{C}$ ,  $V_{GE} = 0/15\text{V}$ ,  $I_C = 50\text{A}$ ,  $r_G = 7\Omega$ , Dynamic test circuit in Figure E)



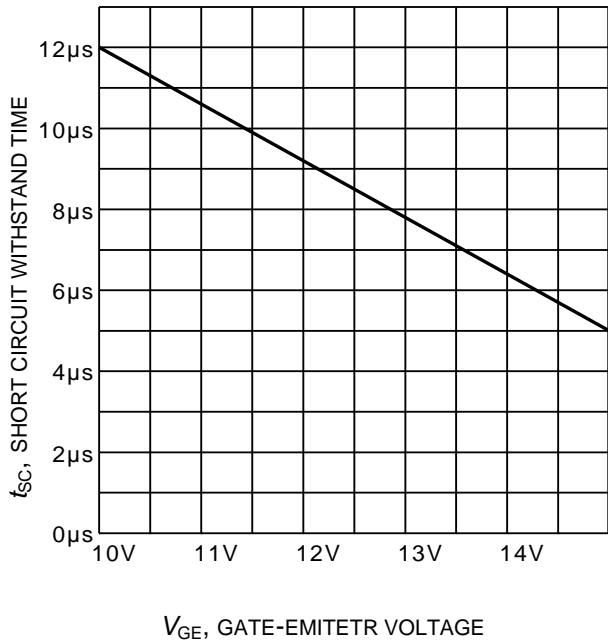
**Figure 17. Typical gate charge**  
( $I_C=50\text{ A}$ )



**Figure 18. Typical capacitance as a function of collector-emitter voltage**  
( $V_{GE}=0\text{V}$ ,  $f = 1\text{ MHz}$ )

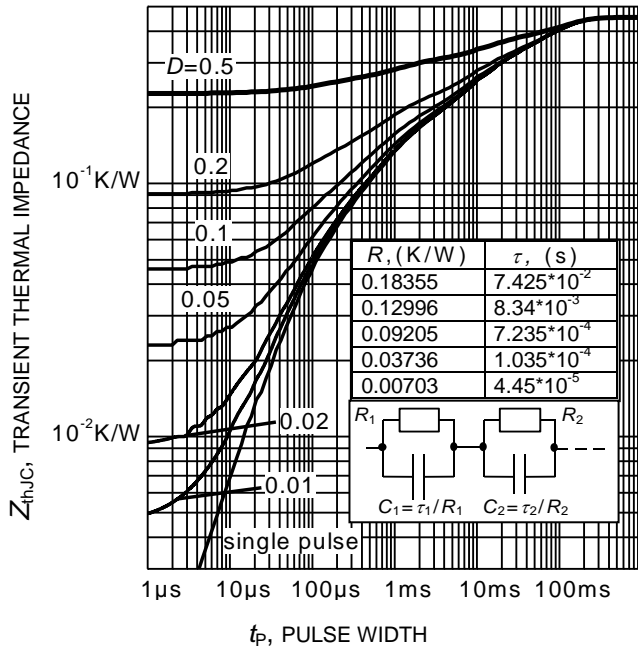


**Figure 19. Typical short circuit collector current as a function of gate-emitter voltage**  
( $V_{CE} \leq 400\text{V}$ ,  $T_j \leq 150^\circ\text{C}$ )



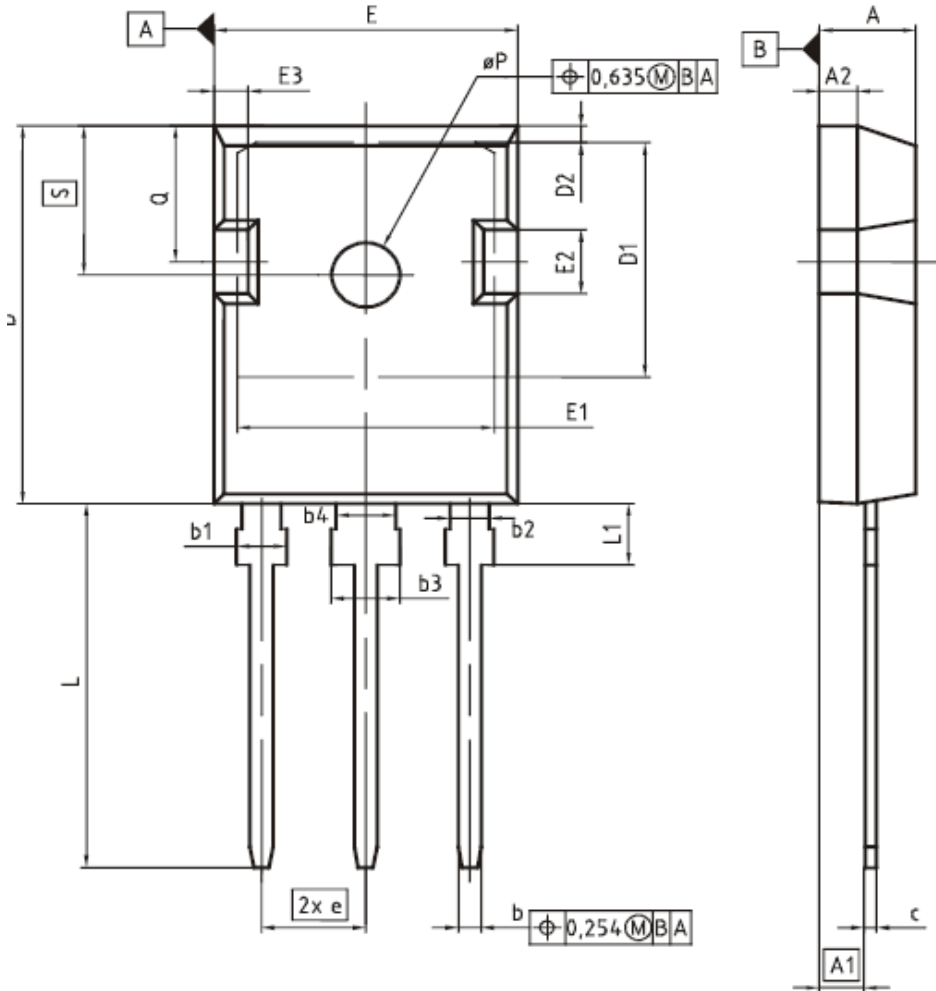
**Figure 20. Short circuit withstand time as a function of gate-emitter voltage**  
( $V_{CE}=400\text{V}$ , start at  $T_j=25^\circ\text{C}$ ,  $T_{jmax}<150^\circ\text{C}$ )





**Figure 21. IGBT transient thermal impedance**  
( $D = t_p / T$ )

PG-TO247-3



| DIM | MILLIMETERS |       | INCHES      |       |
|-----|-------------|-------|-------------|-------|
|     | MIN         | MAX   | MIN         | MAX   |
| A   | 4,83        | 5,21  | 0,190       | 0,205 |
| A1  | 2,27        | 2,54  | 0,089       | 0,100 |
| A2  | 1,85        | 2,16  | 0,073       | 0,085 |
| b   | 1,07        | 1,33  | 0,042       | 0,052 |
| b1  | 1,90        | 2,41  | 0,075       | 0,095 |
| b2  | 1,90        | 2,16  | 0,075       | 0,085 |
| b3  | 2,87        | 3,38  | 0,113       | 0,133 |
| b4  | 2,87        | 3,13  | 0,113       | 0,123 |
| c   | 0,55        | 0,68  | 0,022       | 0,027 |
| D   | 20,80       | 21,10 | 0,819       | 0,831 |
| D1  | 16,25       | 17,65 | 0,640       | 0,695 |
| D2  | 0,95        | 1,35  | 0,037       | 0,053 |
| E   | 15,70       | 16,13 | 0,618       | 0,635 |
| E1  | 13,10       | 14,15 | 0,516       | 0,557 |
| E2  | 3,68        | 5,10  | 0,145       | 0,201 |
| E3  | 1,00        | 2,60  | 0,039       | 0,102 |
| e   | 5,44 (BSC)  |       | 0,214 (BSC) |       |
| N   | 3           |       | 3           |       |
| L   | 19,80       | 20,32 | 0,780       | 0,800 |
| L1  | 4,10        | 4,47  | 0,161       | 0,176 |
| øP  | 3,50        | 3,70  | 0,138       | 0,146 |
| Q   | 5,49        | 6,00  | 0,216       | 0,236 |
| S   | 6,04        | 6,30  | 0,238       | 0,248 |

DOCUMENT NO.  
Z8B00003327

SCALE

EUROPEAN PROJECTION

ISSUE DATE  
09-07-2010

REVISION  
05

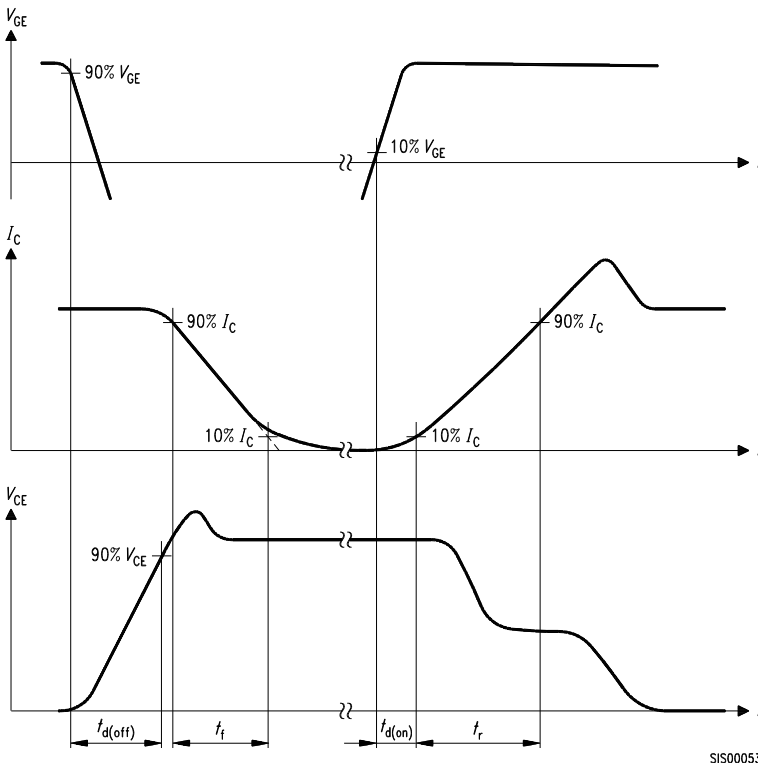


Figure A. Definition of switching times

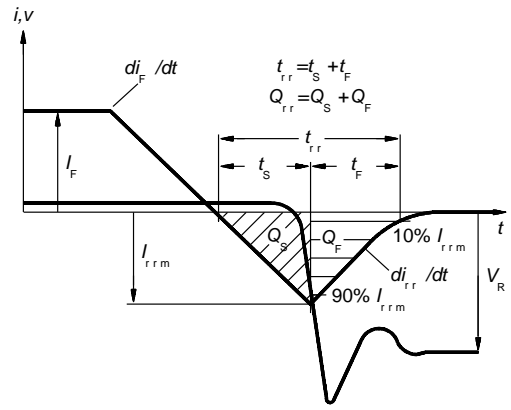


Figure C. Definition of diodes switching characteristics

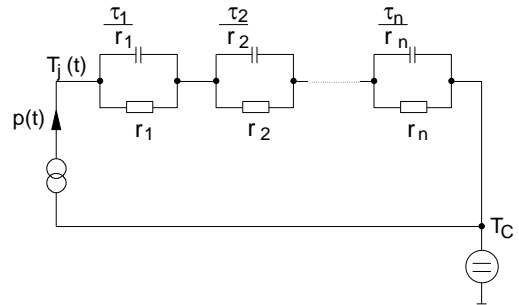


Figure D. Thermal equivalent circuit

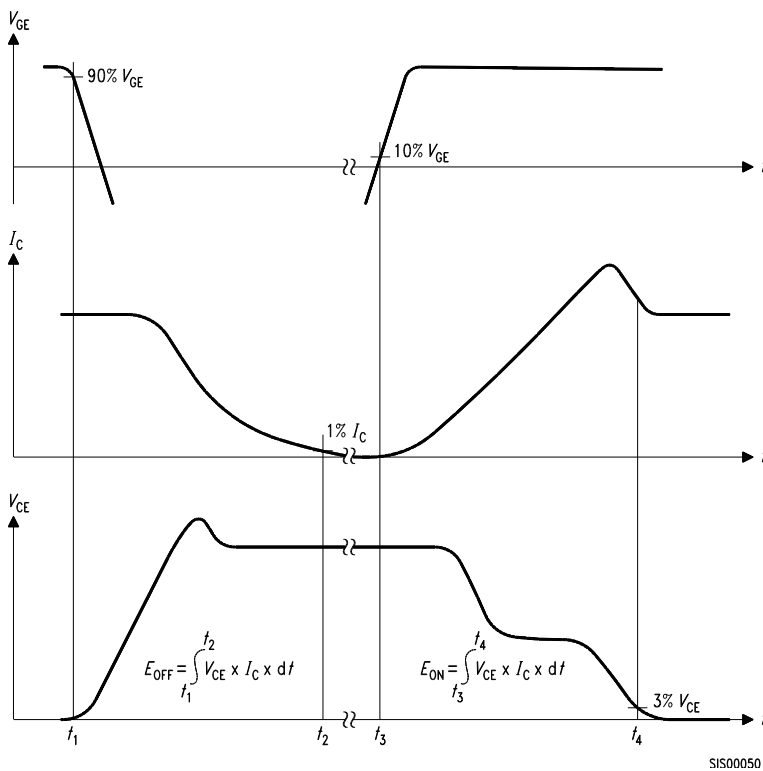


Figure B. Definition of switching losses

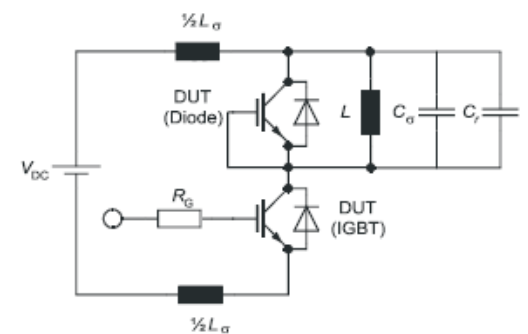


Figure E. Dynamic test circuit  
Parasitic inductance  $L_\sigma$ ,  
Parasitic capacitor  $C_\sigma$ ,  
Relief capacitor  $C_r$   
(only for ZVT switching)

**Published by**  
**Infineon Technologies AG**  
**81726 Munich, Germany**  
**© 2015 Infineon Technologies AG**  
**All Rights Reserved.**

### **Legal Disclaimer**

The information given in this document shall in no event be regarded as a guarantee of conditions or characteristics. With respect to any examples or hints given herein, any typical values stated herein and/or any information regarding the application of the device, Infineon Technologies hereby disclaims any and all warranties and liabilities of any kind, including without limitation, warranties of non-infringement of intellectual property rights of any third party.

### **Information**

For further information on technology, delivery terms and conditions and prices, please contact the nearest Infineon Technologies Office ([www.infineon.com](http://www.infineon.com)).

### **Warnings**

Due to technical requirements, components may contain dangerous substances. For information on the types in question, please contact the nearest Infineon Technologies Office.

The Infineon Technologies component described in this Data Sheet may be used in life-support devices or systems and/or automotive, aviation and aerospace applications or systems only with the express written approval of Infineon Technologies, if a failure of such components can reasonably be expected to cause the failure of that life-support, automotive, aviation and aerospace device or system or to affect the safety or effectiveness of that device or system. Life support devices or systems are intended to be implanted in the human body or to support and/or maintain and sustain and/or protect human life. If they fail, it is reasonable to assume that the health of the user or other persons may be endangered.

# Mouser Electronics

Authorized Distributor

Click to View Pricing, Inventory, Delivery & Lifecycle Information:

[Infineon:](#)

[IGW50N60T](#) [IGP50N60T](#) [IGW50N60TFKSA1](#) [IGP50N60TXKSA1](#)