

PART
NAME

ALUMINUM INSTRUMENT CASE

PART
No.

IA-6160

REVISION
DATE

-

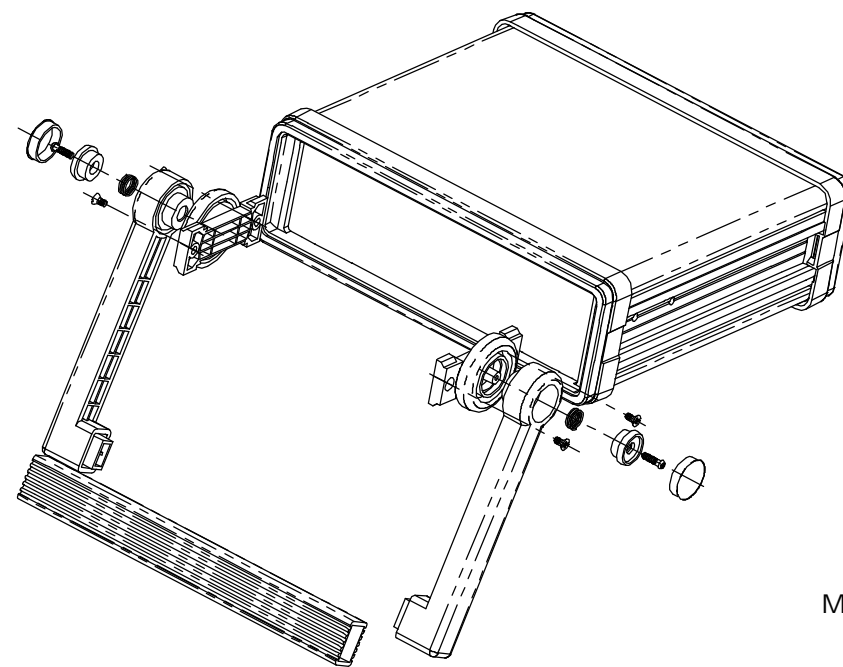
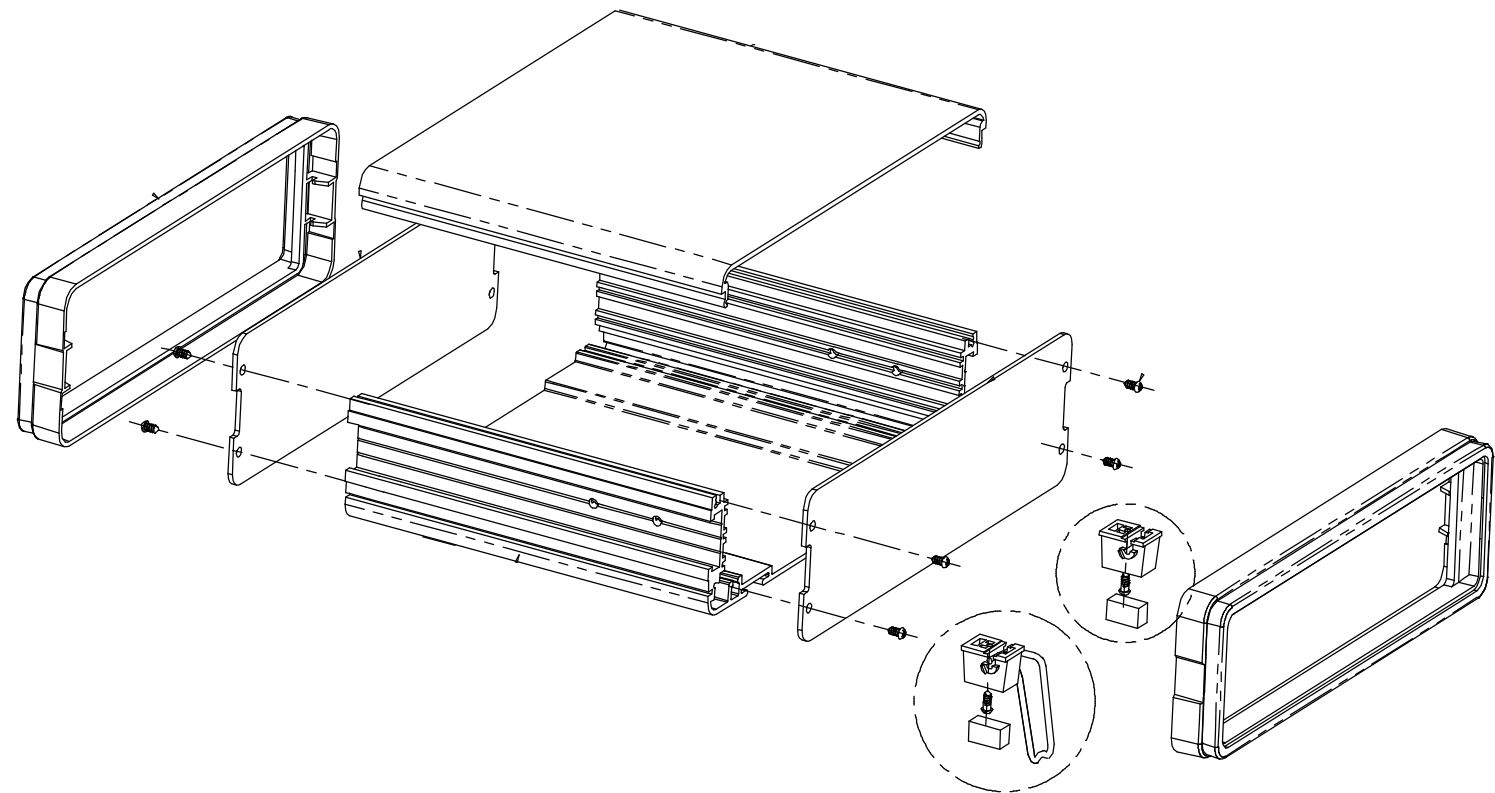
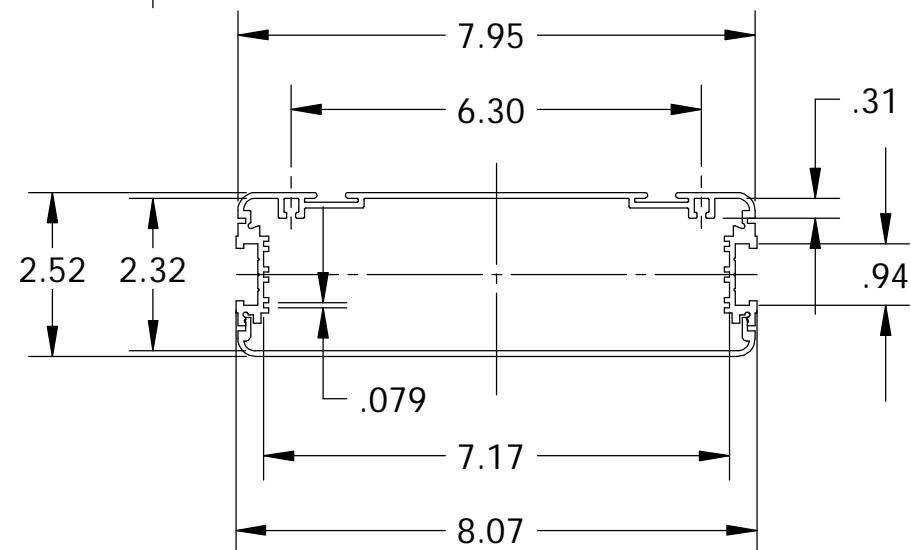
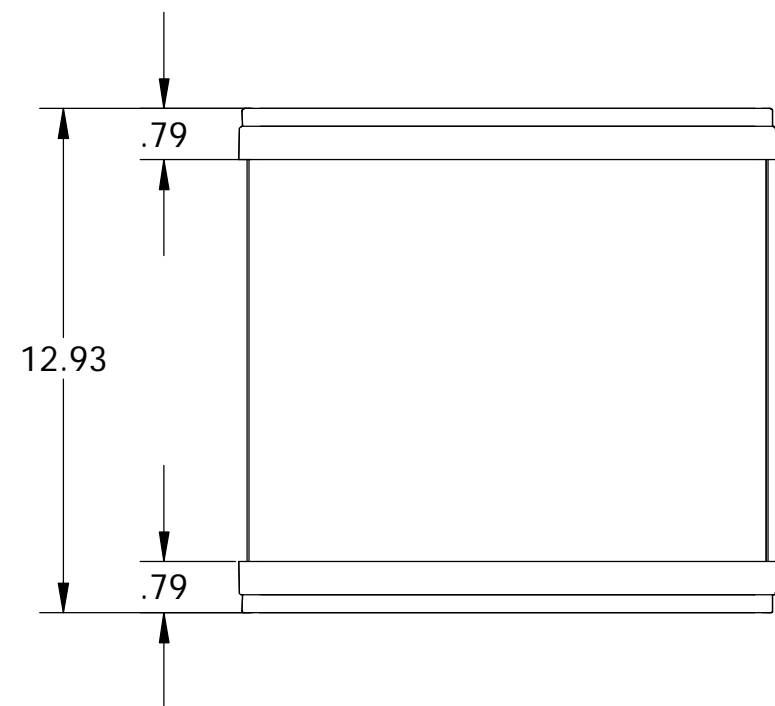
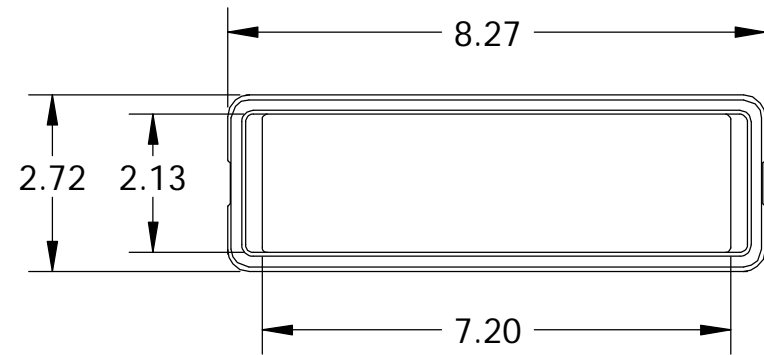

MATERIAL AND FINISH:
BODY: EARTH TONE POWDER COATED ALUMINUM EXTRUSION
BEZELS: LIGHT BROWN PLASTIC
PANELS: NATURAL ALUMINUM
HANDLE: LIGHT GRAY PLASTIC/ANODIZED ALUMINUM EXTRUSION

DIMENSIONS ARE IN INCHES

Mouser Electronics

Authorized Distributor

Click to View Pricing, Inventory, Delivery & Lifecycle Information:

[Bud Industries:](#)

[IA6160](#) [IA-6160](#)