



Is Now Part of



**ON Semiconductor®**

To learn more about ON Semiconductor, please visit our website at  
[www.onsemi.com](http://www.onsemi.com)

Please note: As part of the Fairchild Semiconductor integration, some of the Fairchild orderable part numbers will need to change in order to meet ON Semiconductor's system requirements. Since the ON Semiconductor product management systems do not have the ability to manage part nomenclature that utilizes an underscore (\_), the underscore (\_) in the Fairchild part numbers will be changed to a dash (-). This document may contain device numbers with an underscore (\_). Please check the ON Semiconductor website to verify the updated device numbers. The most current and up-to-date ordering information can be found at [www.onsemi.com](http://www.onsemi.com). Please email any questions regarding the system integration to [Fairchild\\_questions@onsemi.com](mailto:Fairchild_questions@onsemi.com).

ON Semiconductor and the ON Semiconductor logo are trademarks of Semiconductor Components Industries, LLC dba ON Semiconductor or its subsidiaries in the United States and/or other countries. ON Semiconductor owns the rights to a number of patents, trademarks, copyrights, trade secrets, and other intellectual property. A listing of ON Semiconductor's product/patent coverage may be accessed at [www.onsemi.com/site/pdf/Patent-Marking.pdf](http://www.onsemi.com/site/pdf/Patent-Marking.pdf). ON Semiconductor reserves the right to make changes without further notice to any products herein. ON Semiconductor makes no warranty, representation or guarantee regarding the suitability of its products for any particular purpose, nor does ON Semiconductor assume any liability arising out of the application or use of any product or circuit, and specifically disclaims any and all liability, including without limitation special, consequential or incidental damages. Buyer is responsible for its products and applications using ON Semiconductor products, including compliance with all laws, regulations and safety requirements or standards, regardless of any support or applications information provided by ON Semiconductor. "Typical" parameters which may be provided in ON Semiconductor data sheets and/or specifications can and do vary in different applications and actual performance may vary over time. All operating parameters, including "Typicals" must be validated for each customer application by customer's technical experts. ON Semiconductor does not convey any license under its patent rights nor the rights of others. ON Semiconductor products are not designed, intended, or authorized for use as a critical component in life support systems or any FDA Class 3 medical devices or medical devices with a same or similar classification in a foreign jurisdiction or any devices intended for implantation in the human body. Should Buyer purchase or use ON Semiconductor products for any such unintended or unauthorized application, Buyer shall indemnify and hold ON Semiconductor and its officers, employees, subsidiaries, affiliates, and distributors harmless against all claims, costs, damages, and expenses, and reasonable attorney fees arising out of, directly or indirectly, any claim of personal injury or death associated with such unintended or unauthorized use, even if such claim alleges that ON Semiconductor was negligent regarding the design or manufacture of the part. ON Semiconductor is an Equal Opportunity/Affirmative Action Employer. This literature is subject to all applicable copyright laws and is not for resale in any manner.

## FDG6318PZ

### Dual P-Channel, Digital FET

#### General Description

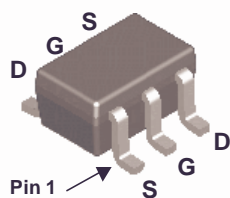
These dual P-Channel logic level enhancement mode MOSFET are produced using Fairchild Semiconductor's especially tailored to minimize on-state resistance. This device has been designed especially for bipolar digital transistors and small signal MOSFETS

#### Applications

- Battery management

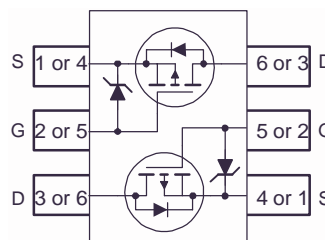
#### Features

- 0.5A, -20V.  $r_{DS(ON)} = 780m\Omega$  (Max) @  $V_{GS} = -4.5V$   
 $r_{DS(ON)} = 1200m\Omega$  (Max) @  $V_{GS} = -2.5V$
- Very low level gate drive requirements allowing direct operation in 3V circuits ( $V_{GS(TH)} < 1.5V$ ).
- Gate-Source Zener for ESD ruggedness (>1.4kV Human Body Model).
- Compact industry standard SC-70-6 surface mount package.



**SC70-6**

The pinouts are symmetrical; pin1 and pin 4 are interchangeable.



#### MOSFET Maximum Ratings $T_A=25^\circ\text{C}$ unless otherwise noted

Symbol	Parameter	Ratings	Units
$V_{DSS}$	Drain to Source Voltage	-20	V
$V_{GS}$	Gate to Source Voltage	$\pm 12$	V
$I_D$	Drain Current		
	Continuous ( $T_C = 25^\circ\text{C}$ , $V_{GS} = -4.5\text{V}$ )	-0.5	A
	Continuous ( $T_C = 100^\circ\text{C}$ , $V_{GS} = -2.5\text{V}$ )	-0.3	A
	Pulsed	Figure 4	
$P_D$	Power dissipation	0.3	W
	Derate above $25^\circ\text{C}$	2.4	mW/ $^\circ\text{C}$
$T_J, T_{STG}$	Operating and Storage Temperature	-55 to 150	$^\circ\text{C}$
ESD	Electrostatic Discharge Rating MIL-STD-883D Human Body Model ( 100pF / 1500 $\Omega$ )	1.4	kV

#### Thermal Characteristics

$R_{\theta JA}$	Thermal Resistance Junction to Ambient (Note 1)	415	$^\circ\text{C/W}$
-----------------	---	-----	--------------------

#### Package Marking and Ordering Information

Device Marking	Device	Package	Reel Size	Tape Width	Quantity
.68	FDG6318PZ	SC70-6	7"	8 mm	3000

**Electrical Characteristics**  $T_A = 25^\circ\text{C}$  unless otherwise noted

Symbol	Parameter	Test Conditions	Min	Typ	Max	Units
--------	-----------	-----------------	-----	-----	-----	-------

**Off Characteristics**

$B_{VDSS}$	Drain to Source Breakdown Voltage	$I_D = -250\mu\text{A}$ , $V_{GS} = 0\text{V}$	-20	-	-	V
$I_{DSS}$	Zero Gate Voltage Drain Current	$V_{DS} = -16\text{V}$ , $V_{GS} = 0\text{V}$	-	-	-3	$\mu\text{A}$
$I_{GSS}$	Gate to Source Leakage Current	$V_{GS} = \pm 12\text{V}$ , $V_{DS} = 0\text{V}$	-	-	$\pm 10$	$\mu\text{A}$

**On Characteristics**

$V_{GS(TH)}$	Gate to Source Threshold Voltage	$V_{GS} = V_{DS}$ , $I_D = -250\mu\text{A}$	-0.65	-0.9	-1.5	V
$r_{DS(ON)}$	Drain to Source On Resistance	$I_D = -0.5\text{A}$ , $V_{GS} = -4.5\text{V}$	-	580	780	$\text{m}\Omega$
		$I_D = -0.4\text{A}$ , $V_{GS} = -2.5\text{V}$	-	910	1200	

**Dynamic Characteristics**

$C_{ISS}$	Input Capacitance	$V_{DS} = -10\text{V}$ , $V_{GS} = 0\text{V}$ , $f = 1\text{MHz}$	-	85.4	-	pF	
$C_{OSS}$	Output Capacitance		-	24.9	-	pF	
$C_{RSS}$	Reverse Transfer Capacitance		-	8.83	-	pF	
$Q_{g(TOT)}$	Total Gate Charge at -4.5V	$V_{GS} = 0\text{V}$ to -4.5V	$V_{DD} = -10\text{V}$ $I_D = -0.5\text{A}$ $I_g = 1.0\text{mA}$	-	1.08	1.62	nC
$Q_{g(-2.5)}$	Total Gate Charge at -2.5V	$V_{GS} = 0\text{V}$ to -2.5V		-	0.67	1.0	nC
$Q_{gs}$	Gate to Source Gate Charge			-	0.21	-	nC
$Q_{gd}$	Gate to Drain "Miller" Charge			-	0.33	-	nC

**Switching Characteristics** ( $V_{GS} = -4.5\text{V}$ )

$t_{ON}$	Turn-On Time	$V_{DD} = -10\text{V}$ , $I_D = -0.5\text{A}$ $V_{GS} = -4.5\text{V}$ , $R_{GS} = 120\Omega$	-	-	35	ns
$t_{d(ON)}$	Turn-On Delay Time		-	10	-	ns
$t_r$	Rise Time		-	13	-	ns
$t_{d(OFF)}$	Turn-Off Delay Time		-	40	-	ns
$t_f$	Fall Time		-	24	-	ns
$t_{OFF}$	Turn-Off Time		-	-	96	ns

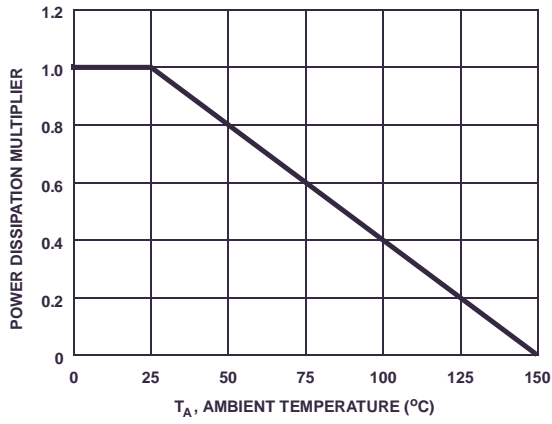
**Drain-Source Diode Characteristics**

$V_{SD}$	Source to Drain Diode Voltage	$I_{SD} = -0.5\text{A}$	-	-0.9	-1.2	V
$t_{rr}$	Reverse Recovery Time	$I_{SD} = -0.5\text{A}$ , $dI_{SD}/dt = 100\text{A}/\mu\text{s}$	-	-	22	ns
$Q_{RR}$	Reverse Recovered Charge	$I_{SD} = -0.5\text{A}$ , $dI_{SD}/dt = 100\text{A}/\mu\text{s}$	-	-	16	nC

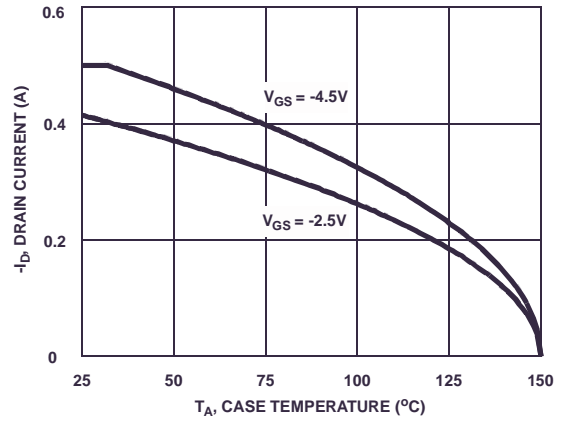
**Notes:**

- $R_{\theta JA}$  is the sum of the junction-to-case and case-to-ambient thermal resistance where the case thermal reference is defined as the solder mounting surface of the center drain pad.  $R_{\theta JC}$  is guaranteed by design while  $R_{\theta CA}$  is determined by user's board design.  $R_{\theta JA} = 415^\circ\text{C}/\text{W}$  when mounted on a 1inch<sup>2</sup> copper pad.

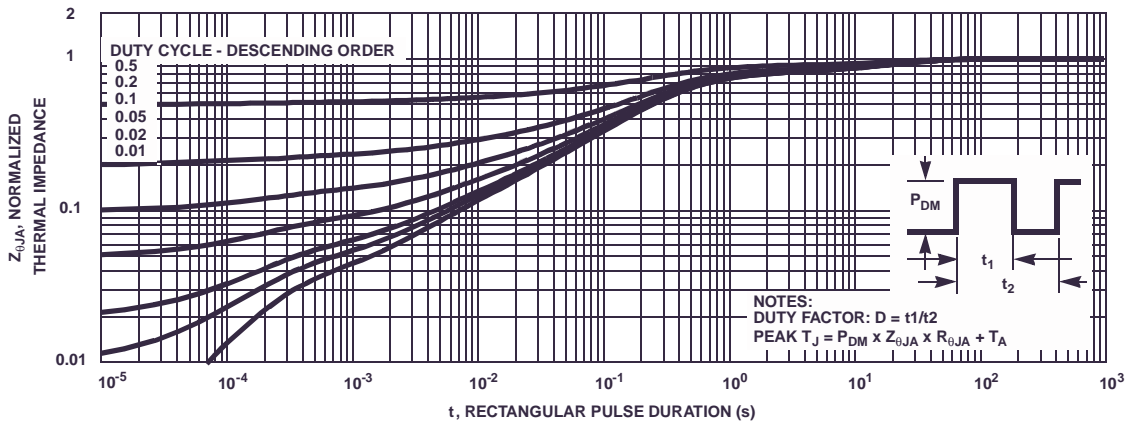
**Typical Characteristic**  $T_A = 25^\circ\text{C}$  unless otherwise noted



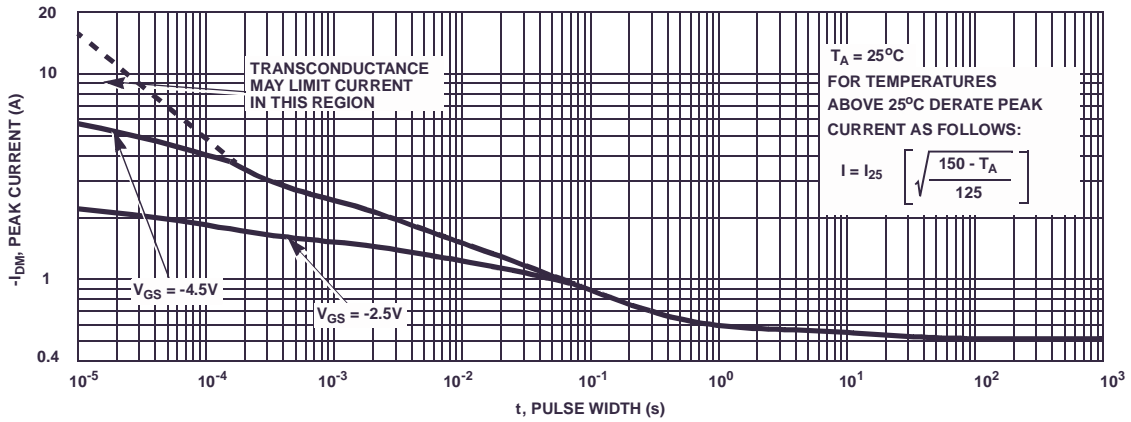
**Figure 1. Normalized Power Dissipation vs Ambient Temperature**



**Figure 2. Maximum Continuous Drain Current vs Case Temperature**

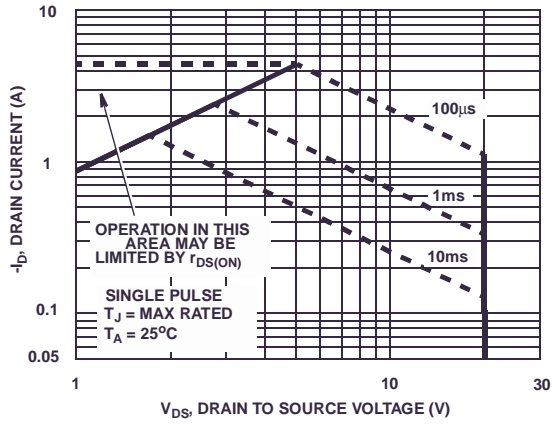


**Figure 3. Normalized Maximum Transient Thermal Impedance**

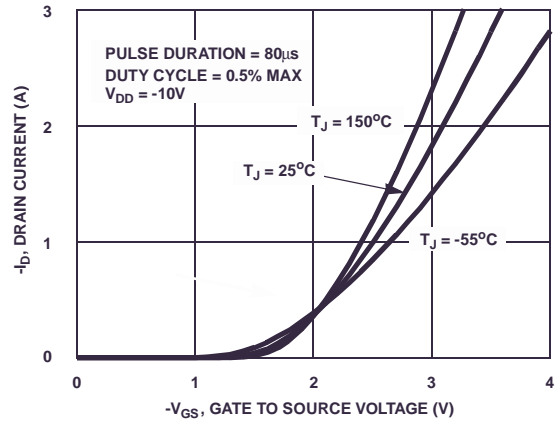


**Figure 4. Peak Current Capability**

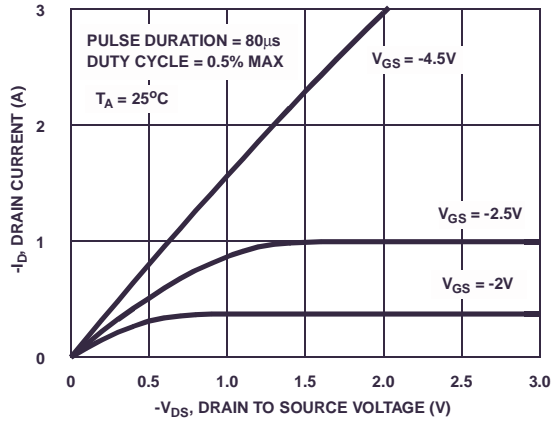
**Typical Characteristic** (Continued)  $T_A = 25^\circ\text{C}$  unless otherwise noted



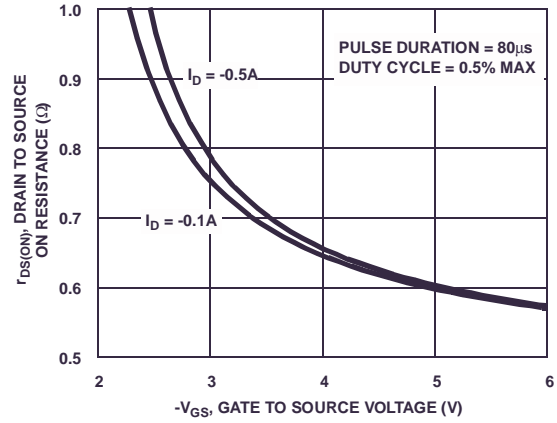
**Figure 5. Forward Bias Safe Operating Area**



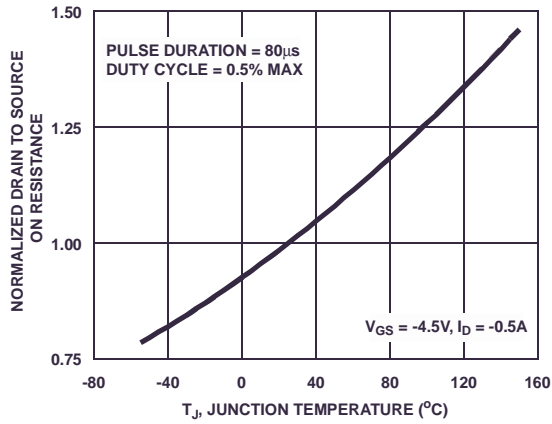
**Figure 6. Transfer Characteristics**



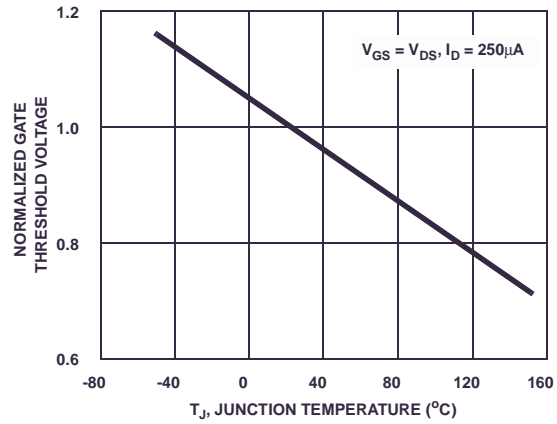
**Figure 7. Saturation Characteristics**



**Figure 8. Drain to Source On Resistance vs Gate Voltage and Drain Current**

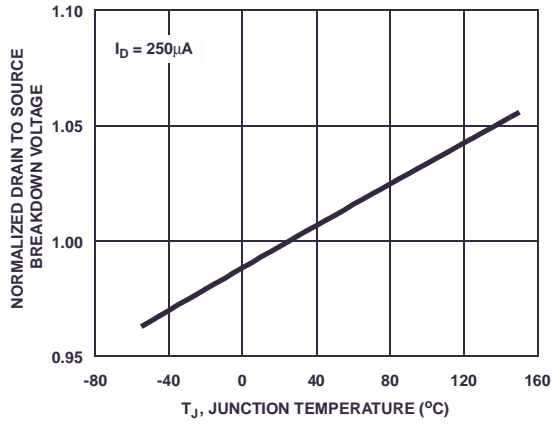


**Figure 9. Normalized Drain to Source On Resistance vs Junction Temperature**

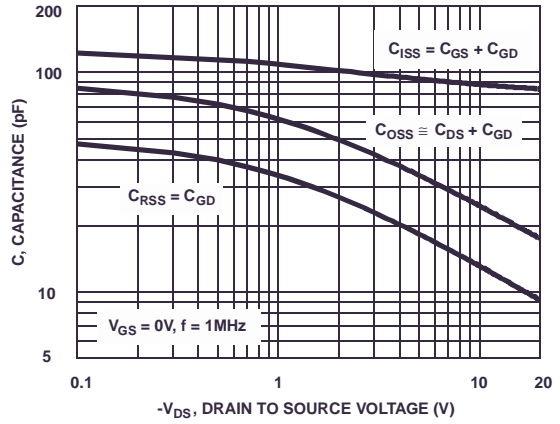


**Figure 10. Normalized Gate Threshold Voltage vs Junction Temperature**

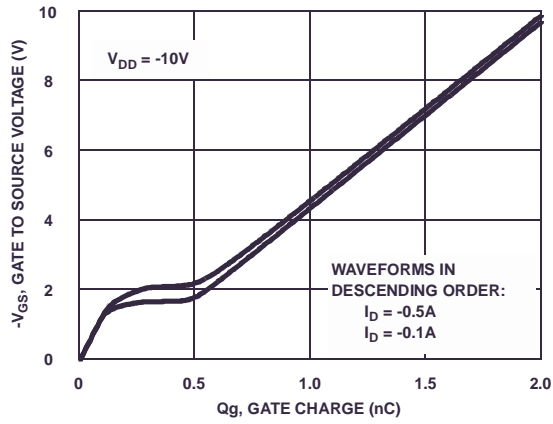
**Typical Characteristic** (Continued)  $T_A = 25^\circ\text{C}$  unless otherwise noted



**Figure 11. Normalized Drain to Source Breakdown Voltage vs Junction Temperature**



**Figure 12. Capacitance vs Drain to Source Voltage**



**Figure 13. Gate Charge Waveforms for Constant Gate Currents**

### PSPICE Electrical Model

.SUBCKT FDG6318PZ 2 1 3 ; rev January 2003

CA 12 8 0.6e-10  
 CB 15 14 1.1e-10  
 CIN 6 8 0.75e-10

DBODY 5 7 DBODYMOD  
 DBREAK 7 11 DBREAKMOD  
 DPLCAP 10 6 DPLCAPMOD

EBREAK 5 11 17 18 -23.3  
 EDS 14 8 5 8 1  
 EGS 13 8 6 8 1  
 ESG 5 10 8 6 1  
 EVTHRES 6 21 19 8 1  
 EVTEMP 6 20 18 22 1

IT 8 17 1

LDRAIN 2 5 1e-9  
 LGATE 1 9 0.47e-9  
 LSOURCE 3 7 0.47e-9

MMED 16 6 8 8 MMEDMOD  
 MSTRO 16 6 8 8 MSTROMOD  
 MWEAK 16 21 8 8 MWEAKMOD

RBREAK 17 18 RBREAKMOD 1  
 RDRAIN 50 16 RDRAINMOD 280e-3  
 RGATE 9 20 12.4  
 RLDRAIN 2 5 10  
 RLGATE 1 9 4.7  
 RLSOURCE 3 7 4.7  
 RSLC1 5 51 RSLCMOD 1e-6  
 RSLC2 5 50 1e3  
 RSOURCE 8 7 RSOURCEMOD 190e-3  
 RVTHRES 22 8 RVTHRESMOD 1  
 RVTEMP 18 19 RVTEMPMOD 1

S1A 6 12 13 8 S1AMOD  
 S1B 13 12 13 8 S1BMOD  
 S2A 6 15 14 13 S2AMOD  
 S2B 13 15 14 13 S2BMOD

VBAT 22 19 DC 1

ESLC 51 50 VALUE={ (V(5,51)/ABS(V(5,51))) \* (PWR(V(5,51)/(1e-6\*20),2.5)) }

.MODEL DBODYMOD D (IS = 7.7e-11 N=1.277 RS = 1e-3 TRS1 = 2.8e-1 TRS2 = 3e-4 XTI=0 IKF=0.5 CJO = 3.9e-11 TT=33e-9 M = 0.50)

.MODEL DBREAKMOD D (RS = 5.3e-1 TRS1 = 5.5e-3 TRS2 = -9e-5)

.MODEL DPLCAPMOD D (CJO = 0.5e-10 IS = 1e-30 N = 10 M = 0.55)

.MODEL MMEDMOD PMOS (VTO = -1.17 KP = 0.6 IS=1e-30 N = 10 TOX = 1 L = 1u W = 1u RG = 12.4)

.MODEL MSTROMOD PMOS (VTO = -1.45 KP = 1.5 IS = 1e-30 N = 10 TOX = 1 L = 1u W = 1u)

.MODEL MWEAKMOD PMOS (VTO = -0.99 KP = 0.05 IS = 1e-30 N = 10 TOX = 1 L = 1u W = 1u RG = 124 RS = 0.1)

.MODEL RBREAKMOD RES (TC1 = 5.5e-4 TC2 = -1e-7)

.MODEL RDRAINMOD RES (TC1 = 2.8e-3 TC2 = 4.9e-6)

.MODEL RSLCMOD RES (TC1 = 3.7e-3 TC2 = 7.8e-6)

.MODEL RSOURCEMOD RES (TC1 = 3e-3 TC2 = 5.2e-6)

.MODEL RVTHRESMOD RES (TC1 = 9e-4 TC2 = 3e-7)

.MODEL RVTEMPMOD RES (TC1 = -5.5e-4 TC2 = -1e-9)

.MODEL S1AMOD VSWITCH (RON = 1e-5 ROFF = 0.1 VON = 0.5 VOFF= 0.2)

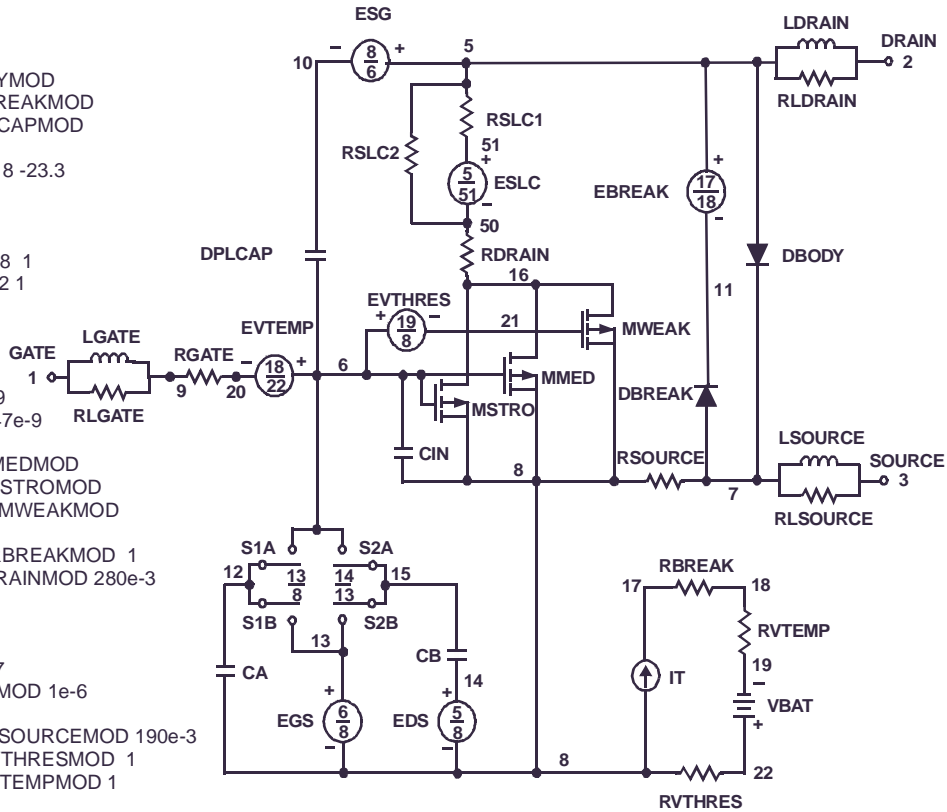
.MODEL S1BMOD VSWITCH (RON = 1e-5 ROFF = 0.1 VON = 0.2 VOFF= 0.5)

.MODEL S2AMOD VSWITCH (RON = 1e-5 ROFF = 0.1 VON = 0.4 VOFF= -0.1)

.MODEL S2BMOD VSWITCH (RON = 1e-5 ROFF = 0.1 VON = -0.1 VOFF= 0.4)

.ENDS

Note: For further discussion of the PSPICE model, consult **A New PSPICE Sub-Circuit for the Power MOSFET Featuring Global Temperature Options**; IEEE Power Electronics Specialist Conference Records, 1991, written by William J. Hepp and C. Frank Wheatley.



## SABER Electrical Model

REV January 2003

template fdg6318pz n2,n1,n3

electrical n2,n1,n3

{

var i iscl

dp..model dbodymod = (isl = 7.7e-11, nl=1.277, rs = 1e-3, trs1 = 2.8e-1, trs2 = 3e-4, xti=0, cjo = 3.9e-11, ikf=0.5, tt = 33e-9, m = 0.50)

dp..model dbreakmod = (rs = 5.3e-1, trs1 = 5.5e-3, trs2 = -9.0e-5)

dp..model dplcapmod = (cjo = 0.5e-10, isl=10e-30, nl=10, m=0.55)

m..model mmedmod = (type=\_p, vto = -1.17, kp=0.6, is=1e-30, tox=1)

m..model mstrongmod = (type=\_p, vto = -1.45, kp = 1.5, is = 1e-30, tox = 1)

m..model mweakmod = (type=\_p, vto = -0.99, kp = 0.05, is = 1e-30, tox = 1, rs=0.1)

sw\_vcsp..model s1amod = (ron = 1e-5, roff = 0.1, von = 0.5, voff = 0.2)

sw\_vcsp..model s1bmod = (ron = 1e-5, roff = 0.1, von = 0.2, voff = 0.5)

sw\_vcsp..model s2amod = (ron = 1e-5, roff = 0.1, von = 0.4, voff = -0.1)

sw\_vcsp..model s2bmod = (ron = 1e-5, roff = 0.1, von = -0.1, voff = 0.4)

c.ca n12 n8 = 0.6e-10

c.cb n15 n14 = 1.1e-10

c.cin n6 n8 = 0.75e-10

dp.dbody n5 n7 = model=dbodymod

dp.dbreak n7 n11 = model=dbreakmod

dp.dplcap n10 n6 = model=dplcapmod

i.it n8 n17 = 1

l.l drain n2 n5 = 1e-9

l.l gate n1 n9 = 0.47e-9

l.l source n3 n7 = 0.47e-9

m.mmed n16 n6 n8 n8 = model=mmedmod, l=1u, w=1u

m.mstrong n16 n6 n8 n8 = model=mstrongmod, l=1u, w=1u

m.mweak n16 n21 n8 n8 = model=mweakmod, l=1u, w=1u

res.rbreak n17 n18 = 1, tc1 = 5.5e-4, tc2 = -1e-7

res.rdrain n50 n16 = 280e-3, tc1 = 2.8e-3, tc2 = 4.9e-6

res.rgate n9 n20 = 12.4

res.rldrain n2 n5 = 10

res.rlgate n1 n9 = 4.7

res.rlsource n3 n7 = 4.7

res.rslc1 n5 n51 = 1e-6, tc1 = 3.7e-3, tc2 = 7.8e-6

res.rslc2 n5 n50 = 1e3

res.rsource n8 n7 = 190e-3, tc1 = 3e-3, tc2 = 5.2e-6

res.rvtemp n18 n19 = 1, tc1 = -5.5e-4, tc2 = -1e-9

res.rvthres n22 n8 = 1, tc1 = 9e-4, tc2 = 3e-7

spe.ebreak n5 n11 n17 n18 = -23.3

spe.eds n14 n8 n5 n8 = 1

spe.egs n13 n8 n6 n8 = 1

spe.esg n5 n10 n6 n8 = 1

spe.evtemp n20 n6 n18 n22 = 1

spe.evthres n6 n21 n19 n8 = 1

sw\_vcsp.s1a n6 n12 n13 n8 = model=s1amod

sw\_vcsp.s1b n13 n12 n13 n8 = model=s1bmod

sw\_vcsp.s2a n6 n15 n14 n13 = model=s2amod

sw\_vcsp.s2b n13 n15 n14 n13 = model=s2bmod

v.vbat n22 n19 = dc=1

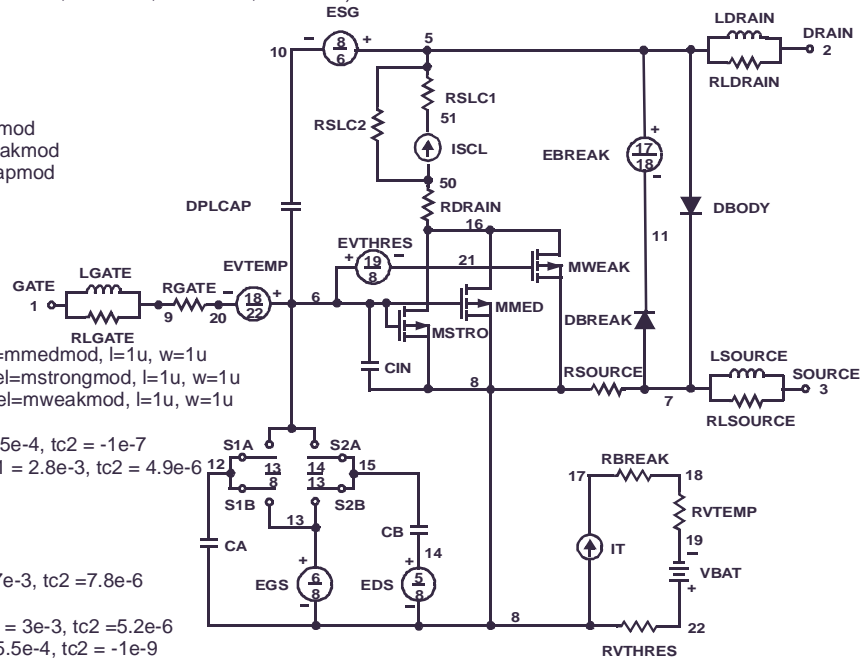
equations {

i (n51->n50) += iscl

iscl: v(n51,n50) = ((v(n5,n51)/(1e-9+abs(v(n5,n51))))\*((abs(v(n5,n51)\*1e6/20))\*\* 2.5))

}

}





### SPICE Thermal Model

REV January 2003  
 FDG6318PZ\_JA Junction Ambient  
 Copper Area= 1sq.in

CTHERM1 Junction c2 0.17e-4  
 CTHERM2 c2 c3 2.7e-4  
 CTHERM3 c3 c4 5.5e-4  
 CTHERM4 c4 c5 1.4e-3  
 CTHERM5 c5 c6 2.2e-3  
 CTHERM6 c6 c7 2.6e-3  
 CTHERM7 c7 c8 6.6e-3  
 CTHERM8 c8 Ambient 0.29

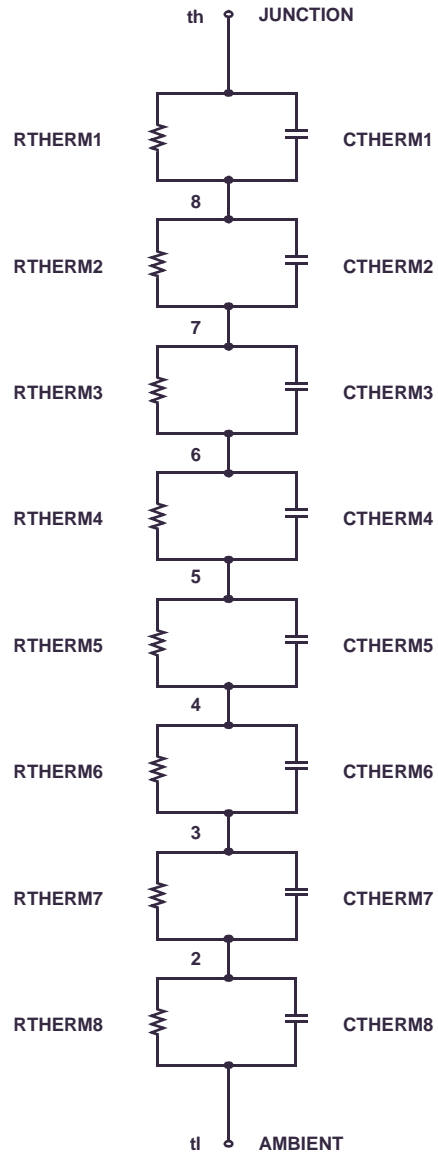
RTHERM1 Junction c2 11.2  
 RTHERM2 c2 c3 11.5  
 RTHERM3 c3 c4 12.5  
 RTHERM4 c4 c5 27  
 RTHERM5 c5 c6 81  
 RTHERM6 c6 c7 88  
 RTHERM7 c7 c8 92  
 RTHERM8 c8 Ambient 93

### SABER Thermal Model

SABER thermal model FDG6318PZ  
 Copper Area= 1sq.in  
 template thermal\_model th tl  
 thermal\_c th, tl

```
{
    ctherm.ctherm1 th c2 = 0.17e-4
    ctherm.ctherm2 c2 c3 = 2.7e-4
    ctherm.ctherm3 c3 c4 = 5.5e-4
    ctherm.ctherm4 c4 c5 = 1.4e-3
    ctherm.ctherm5 c5 c6 = 2.2e-3
    ctherm.ctherm6 c6 c7 = 2.6e-3
    ctherm.ctherm7 c7 c8 = 6.6e-3
    ctherm.ctherm8 c8 tl = 0.29
```

```
rtherm.rtherm1 th c2 = 11.2
rtherm.rtherm2 c2 c3 = 11.5
rtherm.rtherm3 c3 c4 = 12.5
rtherm.rtherm4 c4 c5 = 27
rtherm.rtherm5 c5 c6 = 81
rtherm.rtherm6 c6 c7 = 88
rtherm.rtherm7 c7 c8 = 92
rtherm.rtherm8 c8 tl = 93
}
```



## TRADEMARKS

The following are registered and unregistered trademarks Fairchild Semiconductor owns or is authorized to use and is not intended to be an exhaustive list of all such trademarks.

ACEx™	FACT™	ImpliedDisconnect™	PACMAN™	SPM™
ActiveArray™	FACT Quiet Series™	ISOPLANAR™	POP™	Stealth™
Bottomless™	FAST®	LittleFET™	Power247™	SuperSOT™-3
CoolFET™	FASTr™	MicroFET™	PowerTrench®	SuperSOT™-6
CROSSVOLT™	FRFET™	MicroPak™	QFET™	SuperSOT™-8
DOME™	GlobalOptoisolator™	MICROWIRE™	QS™	SyncFET™
EcoSPARK™	GTO™	MSX™	QT Optoelectronics™	TinyLogic®
E <sup>2</sup> C MOS™	HiSeC™	MSXPro™	Quiet Series™	TruTranslation™
EnSigna™	I <sup>2</sup> C™	OCX™	RapidConfigure™	UHC™
Across the board. Around the world.™		OCXPro™	RapidConnect™	UltraFET®
The Power Franchise™		OPTOLOGIC®	SILENT SWITCHER®	VCX™
Programmable Active Droop™		OPTOPLANAR™	SMART START™	

## DISCLAIMER

FAIRCHILD SEMICONDUCTOR RESERVES THE RIGHT TO MAKE CHANGES WITHOUT FURTHER NOTICE TO ANY PRODUCTS HEREIN TO IMPROVE RELIABILITY, FUNCTION OR DESIGN. FAIRCHILD DOES NOT ASSUME ANY LIABILITY ARISING OUT OF THE APPLICATION OR USE OF ANY PRODUCT OR CIRCUIT DESCRIBED HEREIN; NEITHER DOES IT CONVEY ANY LICENSE UNDER ITS PATENT RIGHTS, NOR THE RIGHTS OF OTHERS.

## LIFE SUPPORT POLICY

FAIRCHILD'S PRODUCTS ARE NOT AUTHORIZED FOR USE AS CRITICAL COMPONENTS IN LIFE SUPPORT DEVICES OR SYSTEMS WITHOUT THE EXPRESS WRITTEN APPROVAL OF FAIRCHILD SEMICONDUCTOR CORPORATION.

As used herein:

1. Life support devices or systems are devices or systems which, (a) are intended for surgical implant into the body, or (b) support or sustain life, or (c) whose failure to perform when properly used in accordance with instructions for use provided in the labeling, can be reasonably expected to result in significant injury to the user.
2. A critical component is any component of a life support device or system whose failure to perform can be reasonably expected to cause the failure of the life support device or system, or to affect its safety or effectiveness.

## PRODUCT STATUS DEFINITIONS

### Definition of Terms

Datasheet Identification	Product Status	Definition
Advance Information	Formative or In Design	This datasheet contains the design specifications for product development. Specifications may change in any manner without notice.
Preliminary	First Production	This datasheet contains preliminary data, and supplementary data will be published at a later date. Fairchild Semiconductor reserves the right to make changes at any time without notice in order to improve design.
No Identification Needed	Full Production	This datasheet contains final specifications. Fairchild Semiconductor reserves the right to make changes at any time without notice in order to improve design.
Obsolete	Not In Production	This datasheet contains specifications on a product that has been discontinued by Fairchild semiconductor. The datasheet is printed for reference information only.

ON Semiconductor and  are trademarks of Semiconductor Components Industries, LLC dba ON Semiconductor or its subsidiaries in the United States and/or other countries. ON Semiconductor owns the rights to a number of patents, trademarks, copyrights, trade secrets, and other intellectual property. A listing of ON Semiconductor's product/patent coverage may be accessed at [www.onsemi.com/site/pdf/Patent-Marking.pdf](http://www.onsemi.com/site/pdf/Patent-Marking.pdf). ON Semiconductor reserves the right to make changes without further notice to any products herein. ON Semiconductor makes no warranty, representation or guarantee regarding the suitability of its products for any particular purpose, nor does ON Semiconductor assume any liability arising out of the application or use of any product or circuit, and specifically disclaims any and all liability, including without limitation special, consequential or incidental damages. Buyer is responsible for its products and applications using ON Semiconductor products, including compliance with all laws, regulations and safety requirements or standards, regardless of any support or applications information provided by ON Semiconductor. "Typical" parameters which may be provided in ON Semiconductor data sheets and/or specifications can and do vary in different applications and actual performance may vary over time. All operating parameters, including "Typicals" must be validated for each customer application by customer's technical experts. ON Semiconductor does not convey any license under its patent rights nor the rights of others. ON Semiconductor products are not designed, intended, or authorized for use as a critical component in life support systems or any FDA Class 3 medical devices or medical devices with a same or similar classification in a foreign jurisdiction or any devices intended for implantation in the human body. Should Buyer purchase or use ON Semiconductor products for any such unintended or unauthorized application, Buyer shall indemnify and hold ON Semiconductor and its officers, employees, subsidiaries, affiliates, and distributors harmless against all claims, costs, damages, and expenses, and reasonable attorney fees arising out of, directly or indirectly, any claim of personal injury or death associated with such unintended or unauthorized use, even if such claim alleges that ON Semiconductor was negligent regarding the design or manufacture of the part. ON Semiconductor is an Equal Opportunity/Affirmative Action Employer. This literature is subject to all applicable copyright laws and is not for resale in any manner.

## PUBLICATION ORDERING INFORMATION

### LITERATURE FULFILLMENT:

Literature Distribution Center for ON Semiconductor  
19521 E. 32nd Pkwy, Aurora, Colorado 80011 USA  
**Phone:** 303-675-2175 or 800-344-3860 Toll Free USA/Canada  
**Fax:** 303-675-2176 or 800-344-3867 Toll Free USA/Canada  
**Email:** [orderlit@onsemi.com](mailto:orderlit@onsemi.com)

**N. American Technical Support:** 800-282-9855 Toll Free  
USA/Canada  
**Europe, Middle East and Africa Technical Support:**  
Phone: 421 33 790 2910  
**Japan Customer Focus Center**  
Phone: 81-3-5817-1050

**ON Semiconductor Website:** [www.onsemi.com](http://www.onsemi.com)  
**Order Literature:** <http://www.onsemi.com/orderlit>  
For additional information, please contact your local  
Sales Representative

# Mouser Electronics

Authorized Distributor

Click to View Pricing, Inventory, Delivery & Lifecycle Information:

[ON Semiconductor:](#)

[FDG6318PZ](#)