

Micropower, Over-The-Top SOT-23, Rail-to-Rail Input and Output Op Amp DESCRIPTION

FEATURES

- Operates with Inputs Above V^+
- Rail-to-Rail Input and Output
- Micropower: 55 μ A Supply Current Max
- Operating Temperature Range: -40°C to 125°C
- Low Profile (1mm) ThinSOT™ Package
- Low Input Offset Voltage: 800 μ V Max
- Single Supply Input Range: 0V to 18V
- High Output Current: 18mA Min
- Specified on 3V, 5V and ± 5 V Supplies
- Output Shutdown on 6-Lead Version
- Reverse Battery Protection to 18V
- High Voltage Gain: 1500V/mV
- Gain Bandwidth Product: 200kHz
- Slew Rate: 0.07V/ μ s

APPLICATIONS

- Portable Instrumentation
- Battery- or Solar-Powered Systems
- Sensor Conditioning
- Supply Current Sensing
- Battery Monitoring
- MUX Amplifiers
- 4mA to 20mA Transmitters

The LT[®]1782 is a 200kHz op amp available in the small SOT-23 package that operates on all single and split supplies with a total voltage of 2.5V to 18V. The amplifier draws less than 55 μ A of quiescent current and has reverse battery protection, drawing negligible current for reverse supply voltages up to 18V.

The input range of the LT1782 includes ground, and a unique feature of this device is its Over-The-Top™ operation capability with either or both of its inputs above the positive rail. The inputs handle 18V both differential and common mode, independent of supply voltage. The input stage incorporates phase reversal protection to prevent false outputs from occurring even when the inputs are 9V below the negative supply.

The LT1782 can drive loads up to 18mA and still maintain rail-to-rail capability. A shutdown feature on the 6-lead version can disable the part, making the output high impedance and reducing quiescent current to 5 μ A. The LT1782 op amp is available in the 5- and 6-lead SOT-23 packages. For applications requiring higher speed, refer to the LT1783.

LT, LT, LTC, LTM, Linear Technology and the Linear logo are registered trademarks and ThinSOT and Over-The-Top are trademarks of Linear Technology Corporation. All other trademarks are the property of their respective owners.

TYPICAL APPLICATION

Positive Supply Rail Current Sense

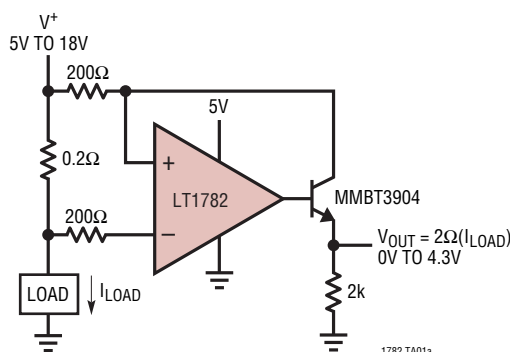

Distribution of Input Offset Voltage

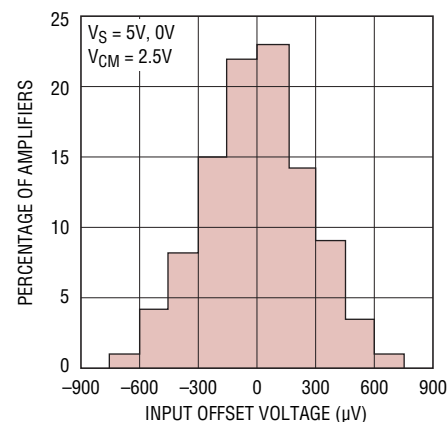

LT1782

ABSOLUTE MAXIMUM RATINGS (Note 1)

Total Supply Voltage (V^+ to V^-)	18V	Specified Temperature Range (Note 4)	
Input Differential Voltage.....	18V	LT1782C.....	-40°C to 85°C
Input Pin Voltage to V^-	+ 24V/-10V	LT1782I.....	-40°C to 85°C
Shutdown Pin Voltage Above V^-	18V	LT1782H	-40°C to 125°C
Shutdown Pin Current	$\pm 10\text{mA}$	Junction Temperature.....	150°C
Output Short-Circuit Duration (Note 2)	Indefinite	Storage Temperature Range.....	-65°C to 150°C
Operating Temperature Range (Note 3)		Lead Temperature (Soldering, 10 sec)	300°C
LT1782C.....	-40°C to 85°C		
LT1782I.....	-40°C to 85°C		
LT1782H	-40°C to 125°C		

PIN CONFIGURATION

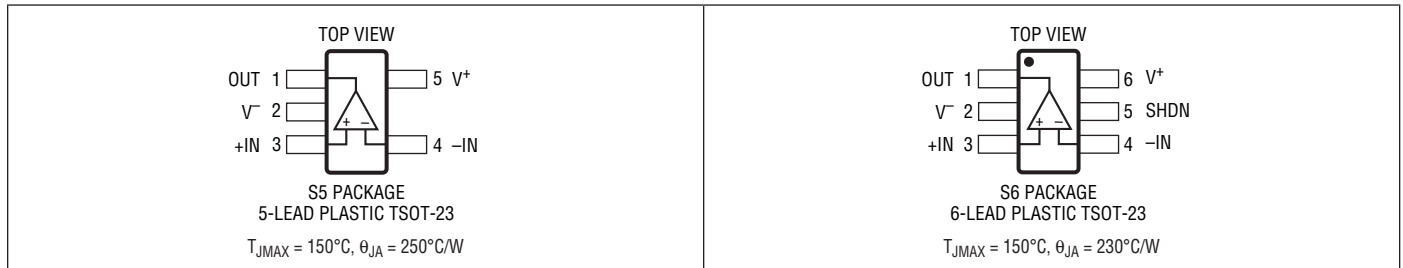

ORDER INFORMATION

LEAD FREE FINISH	TAPE AND REEL	PART MARKING	PACKAGE DESCRIPTION	SPECIFIED TEMPERATURE RANGE
LT1782CS5#PBF	LT1782CS5#TRPBF	LTLD	5-Lead Plastic TSOT-23	0°C to 70°C
LT1782IS5#PBF	LT1782IS5#TRPBF	LTLE	5-Lead Plastic TSOT-23	-40°C to 85°C
LT1782HS5#PBF	LT1782HS5#TRPBF	LTXK	5-Lead Plastic TSOT-23	-40°C to 125°C
LT1782CS6#PBF	LT1782CS6#TRPBF	LTIS	6-Lead Plastic TSOT-23	0°C to 70°C
LT1782IS6#PBF	LT1782IS6#TRPBF	LTIT	6-Lead Plastic TSOT-23	-40°C to 85°C
LT1782HS6#PBF	LT1782HS6#TRPBF	LTXL	6-Lead Plastic TSOT-23	-40°C to 125°C

Consult LTC Marketing for parts specified with wider operating temperature ranges.

Consult LTC Marketing for information on non-standard lead based finish parts.

For more information on lead free part marking, go to: <http://www.linear.com/leadfree/>

For more information on tape and reel specifications, go to: <http://www.linear.com/tapeandree/>

ELECTRICAL CHARACTERISTICS The ● denotes the specifications which apply over the full operating temperature range, otherwise specifications are at $T_A = 25^\circ\text{C}$. $V_S = 3\text{V}, 0\text{V}$; $V_S = 5\text{V}, 0\text{V}$, $V_{\text{CM}} = V_{\text{OUT}} = \text{half supply}$, for the 6-lead part $V_{\text{PIN5}} = 0\text{V}$, pulse power tested unless otherwise specified.

SYMBOL	PARAMETER	CONDITIONS	LT1782C/LT1782I			UNITS	
			MIN	TYP	MAX		
V_{OS}	Input Offset Voltage	$T_A = 25^\circ\text{C}$	●	400	800	μV	
		$0^\circ\text{C} \leq T_A \leq 70^\circ\text{C}$	●		950	μV	
		$-40^\circ\text{C} \leq T_A \leq 85^\circ\text{C}$	●		1100	μV	
$\Delta V_{\text{OS}}/\Delta T$	Input Offset Voltage Drift (Note 7)		●	2	5	$\mu\text{V}/^\circ\text{C}$	
I_{OS}	Input Offset Current	$V_{\text{CM}} = 18\text{V}$ (Note 5)	●	0.7	2	nA	
			●		1	μA	
I_{B}	Input Bias Current	$V_{\text{CM}} = 18$ (Note 5) SHDN or $V_S = 0\text{V}$, $V_{\text{CM}} = 0\text{V}$ to 18V	●	8	15	nA	
			●	6	12	μA	
			●	0.1		nA	
	Input Bias Current Drift	$-40^\circ\text{C} \leq T_A \leq 85^\circ\text{C}$	●	0.01		$\text{nA}/^\circ\text{C}$	
	Input Noise Voltage	0.1Hz to 10Hz		1		$\mu\text{V}_{\text{P-P}}$	
e_{n}	Input Noise Voltage Density	$f = 1\text{kHz}$		50		$\text{nV}/\sqrt{\text{Hz}}$	
i_{n}	Input Noise Current Density	$f = 1\text{kHz}$		0.05		$\text{pA}/\sqrt{\text{Hz}}$	
R_{IN}	Input Resistance	Differential	●	3.4	6.5	$\text{M}\Omega$	
		Common Mode, $V_{\text{CM}} = 0\text{V}$ to $(V_{\text{CC}} - 1\text{V})$	●		5	$\text{G}\Omega$	
		Common Mode, $V_{\text{CM}} = 0\text{V}$ to 18V	●	1.5	3	$\text{M}\Omega$	
C_{IN}	Input Capacitance			5		pF	
	Input Voltage Range		●	0	18	V	
CMRR	Common Mode Rejection Ratio (Note 5)	$V_{\text{CM}} = 0\text{V}$ to $V_{\text{CC}} - 1\text{V}$	●	90	100	dB	
		$V_{\text{CM}} = 0\text{V}$ to 18V (Note 8)	●	68	80	dB	
PSRR	Power Supply Rejection Ratio	$V_S = 3\text{V}$ to 12.5V , $V_{\text{CM}} = V_{\text{O}} = 1\text{V}$	●	90	100	dB	
A_{VOL}	Large-Signal Voltage Gain	$V_S = 3\text{V}$, $V_{\text{O}} = 500\text{mV}$ to 2.5V , $R_{\text{L}} = 10\text{k}$	●	200	1500	V/mV	
		$V_S = 3\text{V}$, $0^\circ\text{C} \leq T_A \leq 70^\circ\text{C}$	●	133		V/mV	
		$V_S = 3\text{V}$, $-40^\circ\text{C} \leq T_A \leq 85^\circ\text{C}$	●	100		V/mV	
		$V_S = 5\text{V}$, $V_{\text{O}} = 500\text{mV}$ to 4.5V , $R_{\text{L}} = 10\text{k}$	●	400	500	V/mV	
		$V_S = 5\text{V}$, $0^\circ\text{C} \leq T_A \leq 70^\circ\text{C}$	●	250		V/mV	
		$V_S = 5\text{V}$, $-40^\circ\text{C} \leq T_A \leq 85^\circ\text{C}$	●	200		V/mV	
V_{OL}	Output Voltage Swing LOW	No Load	●		3	mV	
		$I_{\text{SINK}} = 5\text{mA}$	●		200	500	mV
		$V_S = 5\text{V}$, $I_{\text{SINK}} = 10\text{mA}$	●		400	800	mV
V_{OH}	Output Voltage Swing HIGH	$V_S = 3\text{V}$, No Load	●	2.91	2.94	V	
		$V_S = 3\text{V}$, $I_{\text{SOURCE}} = 5\text{mA}$	●	2.6	2.8	V	
		$V_S = 5\text{V}$, No Load	●	4.91	4.94	V	
		$V_S = 5\text{V}$, $I_{\text{SOURCE}} = 10\text{mA}$	●	4.5	4.74	V	
I_{SC}	Short-Circuit Current (Note 2)	$V_S = 3\text{V}$, Short to GND		5	10	mA	
		$V_S = 3\text{V}$, Short to V_{CC}		15	30	mA	
		$V_S = 5\text{V}$, Short to GND		15	30	mA	
		$V_S = 5\text{V}$, Short to V_{CC}		20	40	mA	
	Minimum Supply Voltage		●	2.7		V	
	Reverse Supply Voltage	$I_{\text{S}} = -100\mu\text{A}$	●	18		V	
I_{S}	Supply Current (Note 6)	$0^\circ\text{C} \leq T_A \leq 70^\circ\text{C}$	●	40	55	μA	
		$-40^\circ\text{C} \leq T_A \leq 85^\circ\text{C}$	●		60	μA	
			●		65	μA	
	Supply Current, SHDN	$V_{\text{PIN5}} = 2\text{V}$, No Load (Note 10)	●	5	15	μA	

ELECTRICAL CHARACTERISTICS

The ● denotes the specifications which apply over the full operating temperature range, otherwise specifications are at $T_A = 25^\circ\text{C}$. $V_S = 3\text{V}, 0\text{V}$; $V_S = 5\text{V}, 0\text{V}$, $V_{\text{CM}} = V_{\text{OUT}} = \text{half supply}$, for the 6-lead part $V_{\text{PIN5}} = 0\text{V}$, pulse power tested unless otherwise specified.

SYMBOL	PARAMETER	CONDITIONS	LT1782C/LT1782I			UNITS
			MIN	TYP	MAX	
I_{SHDN}	Shutdown Pin Current	$V_{\text{PIN5}} = 0.3\text{V}$, No Load (Note 10)	●	0.5		nA
		$V_{\text{PIN5}} = 2\text{V}$, No Load (Note 10)	●	2	8	μA
		$V_{\text{PIN5}} = 5\text{V}$, No Load (Note 10)	●	5		μA
	Shutdown Output Leakage Current	$V_{\text{PIN5}} = 2\text{V}$, No Load (Note 10)	●	0.05	1	μA
	Maximum Shutdown Pin Current	$V_{\text{PIN5}} = 18\text{V}$, No Load (Note 10)	●	10	30	μA
V_L	Shutdown Pin Input Low Voltage	(Note 10)	●		0.3	V
V_H	Shutdown Pin Input High Voltage	(Note 10)	●	2		V
t_{ON}	Turn-On Time	$V_{\text{PIN5}} = 5\text{V}$ to 0V , $R_L = 10\text{k}$ (Note 10)		100		μs
t_{OFF}	Turn-Off Time	$V_{\text{PIN5}} = 0\text{V}$ to 5V , $R_L = 10\text{k}$ (Note 10)		6		μs
GBW	Gain Bandwidth Product (Note 5)	$f = 5\text{kHz}$	●	110	200	kHz
		$0^\circ\text{C} \leq T_A \leq 70^\circ\text{C}$	●	100		kHz
		$-40^\circ\text{C} \leq T_A \leq 85^\circ\text{C}$	●	90		kHz
SR	Slew Rate (Note 5)	$A_V = -1$, $R_L = \infty$	●	0.035	0.07	V/ μs
		$0^\circ\text{C} \leq T_A \leq 70^\circ\text{C}$	●	0.031		V/ μs
		$-40^\circ\text{C} \leq T_A \leq 85^\circ\text{C}$	●	0.028		V/ μs
t_S	Settling Time	$V_S = 5\text{V}$, $\Delta V_{\text{OUT}} = 2\text{V}$ to 0.1% , $A_V = -1$		45		μs
THD	Distortion	$V_S = 3\text{V}$, $V_O = 2V_{\text{P-P}}$, $A_V = 1$, $R_L = 10\text{k}$, $f = 1\text{kHz}$		0.003		%
FPBW	Full-Power Bandwidth (Note 9)	$V_{\text{OUT}} = 2V_{\text{P-P}}$		11		kHz

The ● denotes the specifications which apply over the full operating temperature range, otherwise specifications are at $T_A = 25^\circ\text{C}$. $V_S = \pm 5\text{V}$, $V_{\text{CM}} = 0\text{V}$, $V_{\text{OUT}} = 0\text{V}$, for the 6-lead part $V_{\text{PIN5}} = V^-$, pulse power tested unless otherwise specified.

SYMBOL	PARAMETER	CONDITIONS	LT1782C/LT1782I			UNITS
			MIN	TYP	MAX	
V_{OS}	Input Offset Voltage	$T_A = 25^\circ\text{C}$	●	500	900	μV
		$0^\circ\text{C} \leq T_A \leq 70^\circ\text{C}$	●		1050	μV
		$-40^\circ\text{C} \leq T_A \leq 85^\circ\text{C}$	●		1200	μV
$\Delta V_{\text{OS}}/\Delta T$	Input Offset Voltage Drift (Note 7)		●	2	5	$\mu\text{V}/^\circ\text{C}$
I_{OS}	Input Offset Current		●	0.7	2	nA
I_B	Input Bias Current		●	8	15	nA
	Input Bias Current Drift		●	0.01		nA/ $^\circ\text{C}$
	Input Noise Voltage	0.1Hz to 10Hz		1		$\mu\text{V}_{\text{P-P}}$
e_n	Input Noise Voltage Density	$f = 1\text{kHz}$		50		nV/ $\sqrt{\text{Hz}}$
i_n	Input Noise Current Density	$f = 1\text{kHz}$		0.05		pA/ $\sqrt{\text{Hz}}$
R_{IN}	Input Resistance	Differential	●	3.4	6.5	M Ω
		Common Mode, $V_{\text{CM}} = -5\text{V}$ to 13V	●	1.5	3	M Ω
C_{IN}	Input Capacitance			5		pF
	Input Voltage Range		●	-5	13	V
CMRR	Common Mode Rejection Ratio	$V_{\text{CM}} = -5\text{V}$ to 13V	●	68	80	dB
A_{VOL}	Large-Signal Voltage Gain	$V_O = \pm 4\text{V}$, $R_L = 10\text{k}$	●	55	150	V/mV
		$0^\circ\text{C} \leq T_A \leq 70^\circ\text{C}$	●	40		V/mV
		$-40^\circ\text{C} \leq T_A \leq 85^\circ\text{C}$	●	30		V/mV

ELECTRICAL CHARACTERISTICS The ● denotes the specifications which apply over the full operating temperature range, otherwise specifications are at $T_A = 25^\circ\text{C}$. $V_S = \pm 5\text{V}$, $V_{CM} = 0\text{V}$, $V_{OUT} = 0\text{V}$, for the 6-lead part $V_{PIN5} = V^-$, pulse power tested unless otherwise specified.

SYMBOL	PARAMETER	CONDITIONS	LT1782C/LT1782I			UNITS
			MIN	TYP	MAX	
V_{OL}	Output Voltage Swing LOW	No Load	●	-4.997	-4.992	V
		$I_{SINK} = 5\text{mA}$	●	-4.8	-4.5	V
		$I_{SINK} = 10\text{mA}$	●	-4.6	-4.2	V
V_{OH}	Output Voltage Swing HIGH	No Load	●	4.91	4.94	V
		$I_{SINK} = 5\text{mA}$	●	4.6	4.8	V
		$I_{SINK} = 10\text{mA}$	●	4.5	4.74	V
I_{SC}	Short-Circuit Current (Note 2)	Short to GND $0^\circ\text{C} \leq T_A \leq 70^\circ\text{C}$	●	18 15	30	mA mA
PSRR	Power Supply Rejection Ratio	$V_S = \pm 1.5\text{V}$ to $\pm 9\text{V}$	●	90	100	dB
I_S	Supply Current	$0^\circ\text{C} \leq T_A \leq 70^\circ\text{C}$	●	45	60	μA
		$-40^\circ\text{C} \leq T_A \leq 85^\circ\text{C}$	●		65	μA
			●		70	μA
	Supply Current, SHDN	$V_{PIN5} = -3\text{V}$, $V_S = \pm 5\text{V}$, No Load (Note 10)	●	6	20	μA
I_{SHDN}	Shutdown Pin Current	$V_{PIN5} = -4.7\text{V}$, $V_S = \pm 5\text{V}$, No Load (Note 10)	●	0.5		nA
		$V_{PIN5} = -3\text{V}$, $V_S = \pm 5\text{V}$, No Load (Note 10)	●	2	8	μA
		Maximum Shutdown Pin Current	●	10	30	μA
	Shutdown Output Leakage Current	$V_{PIN5} = -7\text{V}$, $V_S = \pm 9\text{V}$, No Load (Note 10)	●	0.05	1	μA
V_L	Shutdown Pin Input Low Voltage	$V_S = \pm 5\text{V}$ (Note 10)	●		-4.7	V
V_H	Shutdown Pin Input High Voltage	$V_S = \pm 5\text{V}$ (Note 10)	●	-3		V
t_{ON}	Turn-On Time	$V_{PIN5} = 0\text{V}$ to -5V , $R_L = 10\text{k}$ (Note 10)	●	100		μs
t_{OFF}	Turn-Off Time	$V_{PIN5} = -5\text{V}$ to 0V , $R_L = 10\text{k}$ (Note 10)	●	6		μs
GBW	Gain Bandwidth Product	$f = 5\text{kHz}$	●	120	225	kHz
		$0^\circ\text{C} \leq T_A \leq 70^\circ\text{C}$	●	110		kHz
		$-40^\circ\text{C} \leq T_A \leq 85^\circ\text{C}$	●	100		kHz
SR	Slew Rate	$A_V = -1$, $R_L = \infty$, $V_O = \pm 4\text{V}$, Measured at $V_O = \pm 2\text{V}$	●	0.0375	0.075	V/ μs
		$0^\circ\text{C} \leq T_A \leq 70^\circ\text{C}$	●	0.033		V/ μs
		$-40^\circ\text{C} \leq T_A \leq 85^\circ\text{C}$	●	0.030		V/ μs
t_S	Settling Time	$\Delta V_{OUT} = 4\text{V}$ to 0.1% , $A_V = 1$		50		μs
FPBW	Full-Power Bandwidth (Note 9)	$V_{OUT} = 8V_{P-P}$		3		kHz

The ● denotes the specifications which apply over the full operating temperature range of $-40^\circ\text{C} \leq T_A \leq 125^\circ\text{C}$. $V_S = 3\text{V}$, 0V ; $V_S = 5\text{V}$, 0V ; $V_{CM} = V_{OUT} = \text{half supply}$, for the 6-lead part $V_{PIN5} = 0\text{V}$, pulse power tested unless otherwise specified. (Note 4)

SYMBOL	PARAMETER	CONDITIONS	LT1782H			UNITS
			MIN	TYP	MAX	
V_{OS}	Input Offset Voltage		●	400	800	μV
					3	mV
$\Delta V_{OS}/\Delta T$	Input Offset Voltage Drift		●		15	$\mu\text{V}/^\circ\text{C}$
I_{OS}	Input Offset Current	$V_{CM} = 18\text{V}$ (Note 5)	●		3	nA
			●		2	μA
I_B	Input Bias Current	$V_{CM} = 18\text{V}$ (Note 5)	●		30	nA
			●		25	μA
	Input Voltage Range		●	0.3	18	V
CMRR	Common Mode Rejection Ratio	$V_{CM} = 0.3\text{V}$ to $V_{CC} - 1\text{V}$	●	76		dB
		$V_{CM} = 0.3\text{V}$ to 18V	●	60		dB

ELECTRICAL CHARACTERISTICS

The ● denotes the specifications which apply over the full operating temperature range of $-40^{\circ}\text{C} \leq T_A \leq 125^{\circ}\text{C}$. $V_S = 3\text{V}, 0\text{V}$; $V_S = 5\text{V}, 0\text{V}$; $V_{\text{CM}} = V_{\text{OUT}} = \text{half supply}$, for the 6-lead part $V_{\text{PIN5}} = 0\text{V}$, pulse power tested unless otherwise specified. (Note 4)

SYMBOL	PARAMETER	CONDITIONS	LT1782H			UNITS
			MIN	TYP	MAX	
A_{VOL}	Large-Signal Voltage Gain	$V_S = 3\text{V}, V_O = 500\text{mV to } 2.5\text{V}, R_L = 10\text{k}$	● 200	1500		V/mV
			50			V/mV
V_{OL}	Output Voltage Swing LOW	$V_S = 5\text{V}, V_O = 500\text{mV to } 4.5\text{V}, R_L = 10\text{k}$	● 400	1500		V/mV
			80			V/mV
V_{OH}	Output Voltage Swing HIGH	No Load	●		15	mV
		$I_{\text{SINK}} = 5\text{mA}$	●		900	mV
		$V_S = 5\text{V}, I_{\text{SINK}} = 10\text{mA}$	●		1500	mV
V_{OH}	Output Voltage Swing HIGH	$V_S = 3\text{V}, \text{No Load}$	●	2.85		V
		$V_S = 3\text{V}, I_{\text{SOURCE}} = 5\text{mA}$	●	2.20		V
		$V_S = 5\text{V}, \text{No Load}$	●	4.85		V
		$V_S = 5\text{V}, I_{\text{SOURCE}} = 10\text{mA}$	●	3.80		V
PSRR	Power Supply Rejection Ratio	$V_S = 3\text{V to } 12.5\text{V}, V_{\text{CM}} = V_O = 1\text{V}$	●	80		dB
	Minimum Supply Voltage		●	2.7		V
	Reverse Supply Voltage	$I_S = -100\mu\text{A}$	●	18		V
I_S	Supply Current		●	40	55	μA
					100	μA
I_{SHDN}	Supply Current, SHDN	$V_{\text{PIN5}} = 2\text{V}, \text{No Load (Note 10)}$	●		25	μA
	Shutdown Pin Current	$V_{\text{PIN5}} = 0.3\text{V}, \text{No Load (Note 10)}$ $V_{\text{PIN5}} = 2\text{V}, \text{No Load (Note 10)}$	● ●	0.5	12	nA μA
I_{SHDN}	Output Leakage Current	$V_{\text{PIN5}} = 2\text{V}, \text{No Load (Note 10)}$	●		3	μA
	Maximum Shutdown Pin Current	$V_{\text{PIN5}} = 18\text{V}, \text{No Load}$	●		45	μA
	Shutdown Pin Input Low Voltage	(Note 10)	●		0.3	V
V_{H}	Shutdown Pin Input High Voltage	(Note 10)	●	2		V
GBW	Gain Bandwidth Product	$f = 10\text{kHz (Note 5)}$	●	110	200	kHz
				65		kHz
SR	Slew Rate	$A_V = -1, R_L = \infty \text{ (Note 7)}$	●	0.035	0.07	V/ μs
				0.020		V/ μs

The ● denotes the specifications which apply over the full operating temperature range of $-40^{\circ}\text{C} \leq T_A \leq 125^{\circ}\text{C}$. $V_S = \pm 5\text{V}, V_{\text{CM}} = 0\text{V}, V_{\text{OUT}} = 0\text{V}$, for the 6-lead part $V_{\text{PIN5}} = V^-$, pulse power tested unless otherwise specified. (Note 4)

SYMBOL	PARAMETER	CONDITIONS	LT1782H			UNITS
			MIN	TYP	MAX	
V_{OS}	Input Offset Voltage		●	500	900	μV
					3.2	mV
$\Delta V_{\text{OS}}/\Delta T$	Input Offset Voltage Drift (Note 9)		●		15	$\mu\text{V}/^{\circ}\text{C}$
I_{OS}	Input Offset Current		●		3	nA
I_{B}	Input Bias Current		●		30	nA
CMRR	Common Mode Rejection Ratio	$V_{\text{CM}} = -4.7\text{V to } 13\text{V}$	●	60		dB
A_{VOL}	Large-Signal Voltage Gain	$V_S = \pm 4\text{V}, R_L = 10\text{k}$	●	55	150	V/mV
				20		V/mV
V_O	Output Voltage Swing	No Load	●	± 4.85		V
		$I_{\text{SINK}} = \pm 5\text{mA}$	●	± 4.10		V
		$I_{\text{SINK}} = \pm 10\text{mA}$	●	± 3.50		V

ELECTRICAL CHARACTERISTICS The ● denotes the specifications which apply over the full operating temperature range of $-40^{\circ}\text{C} \leq T_A \leq 125^{\circ}\text{C}$. $V_S = \pm 5\text{V}$, $V_{\text{CM}} = 0\text{V}$, $V_{\text{OUT}} = 0\text{V}$, for the 6-lead part $V_{\text{PIN5}} = V^-$, pulse power tested unless otherwise specified. (Note 4)

SYMBOL	PARAMETER	CONDITIONS	LT1782H			UNITS
			MIN	TYP	MAX	
PSRR	Power Supply Rejection Ratio	$V_S = \pm 1.5\text{V}$ to $\pm 9\text{V}$	●	80		dB
	Minimum Supply Voltage		●	± 1.35		V
I_S	Supply Current		●	45	60 110	μA μA
	Supply Current, SHDN	$V_{\text{PIN5}} = -3\text{V}$, $V_S = \pm 5\text{V}$, No Load (Note 10)	●		25	μA
I_{SHDN}	Shutdown Pin Current	$V_{\text{PIN5}} = -4.7\text{V}$, $V_S = \pm 5\text{V}$, No Load (Note 10) $V_{\text{PIN5}} = -3\text{V}$, $V_S = \pm 5\text{V}$, No Load (Note 10)	● ●	0.5	12	nA μA
	Maximum Shutdown Pin Current	$V_{\text{PIN5}} = 9\text{V}$, $V_S = \pm 9\text{V}$, No Load (Note 10)	●		45	μA
	Output Leakage Current	$V_{\text{PIN5}} = -7\text{V}$, $V_S = \pm 9\text{V}$, No Load	●		3	μA
V_L	Shutdown Pin Input Low Voltage	$V_S = \pm 5\text{V}$	●		-4.7	V
V_H	Shutdown Pin Input High Voltage	$V_S = \pm 5\text{V}$	●	-3		V
GBW	Gain Bandwidth Product	$f = 5\text{kHz}$	●	120	225	kHz
			●	70		kHz
SR	Slew Rate	$A_V = -1$, $R_L = \infty$, $V_O = \pm 4\text{V}$ Measured at $V_O = \pm 2\text{V}$	●	0.0375	0.075	$\text{V}/\mu\text{s}$
			●	0.0220		$\text{V}/\mu\text{s}$

Note 1: Stresses beyond those listed under Absolute Maximum Ratings may cause permanent damage to the device. Exposure to any Absolute Maximum Rating condition for extended periods may affect device reliability and lifetime.

Note 2: A heat sink may be required to keep the junction temperature below absolute maximum.

Note 3: The LT1782C and LT1782I are guaranteed functional over the operating temperature range of -40°C to 85°C . The LT1782H is guaranteed functional over the operating temperature range of -40°C to 125°C .

Note 4: The LT1782C is guaranteed to meet specified performance from 0°C to 70°C . The LT1782C is designed, characterized and expected to meet specified performance from -40°C to 85°C but is not tested or QA sampled at these temperatures. The LT1782I is guaranteed to meet specified performance from -40°C to 85°C . The LT1782H is guaranteed to meet specified performance from -40°C to 125°C .

Note 5: $V_S = 5\text{V}$ limits are guaranteed by correlation to $V_S = 3\text{V}$ and $V_S = \pm 5\text{V}$ or $V_S = \pm 9\text{V}$ tests.

Note 6: $V_S = 3\text{V}$ limits are guaranteed by correlation to $V_S = 5\text{V}$ and $V_S = \pm 5\text{V}$ or $V_S = \pm 9\text{V}$ tests.

Note 7: Guaranteed by correlation to slew rate at $V_S = \pm 5\text{V}$, and GBW at $V_S = 3\text{V}$ and $V_S = \pm 5\text{V}$ tests.

Note 8: This specification implies a typical input offset voltage of 1.8mV at $V_{\text{CM}} = 18\text{V}$ and a maximum input offset voltage of 7.2mV at $V_{\text{CM}} = 18\text{V}$.

Note 9: This parameter is not 100% tested.

Note 10: Specifications apply to 6-lead SOT-23 with shutdown.

Note 11: Full-power bandwidth is calculated for the slew rate.
 $\text{FPBW} = \text{SR}/2\pi V_P$.

TYPICAL PERFORMANCE CHARACTERISTICS

Supply Current vs Supply Voltage

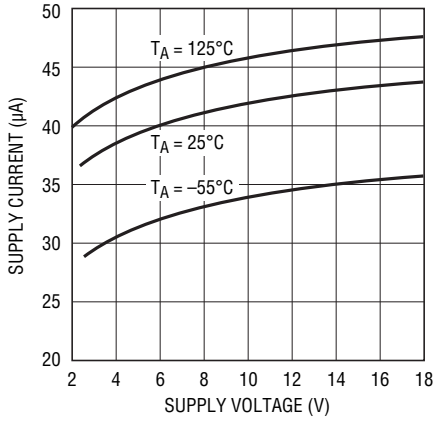

1782 G01

Minimum Supply Voltage

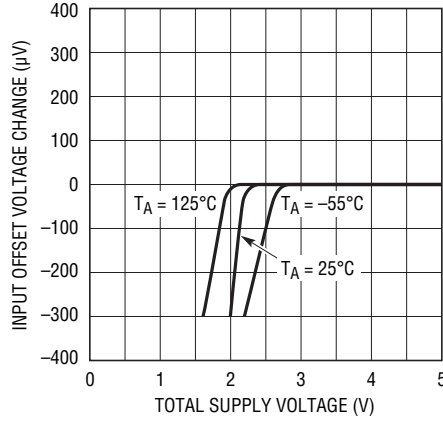

1782 G02

Output Voltage vs Large Input Voltage

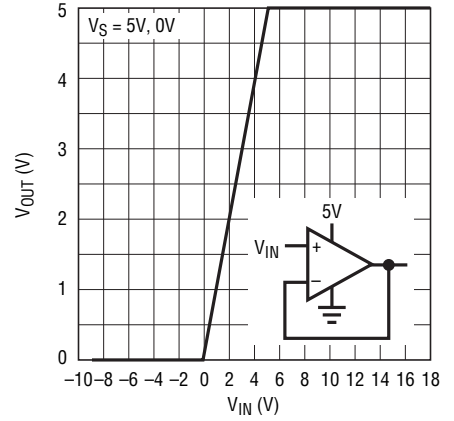

1782 G03

Input Bias Current vs Common Mode Voltage

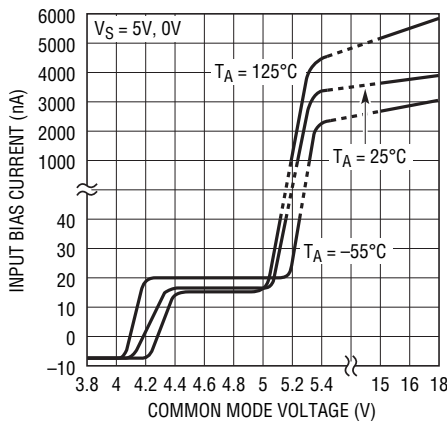

1782 G04

Output Saturation Voltage vs Load Current (Output High)

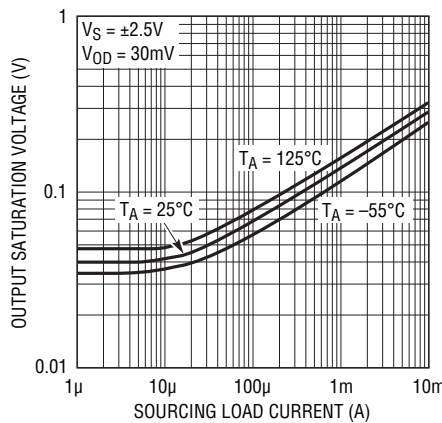

1782 G05

Output Saturation Voltage vs Load Current (Output Low)

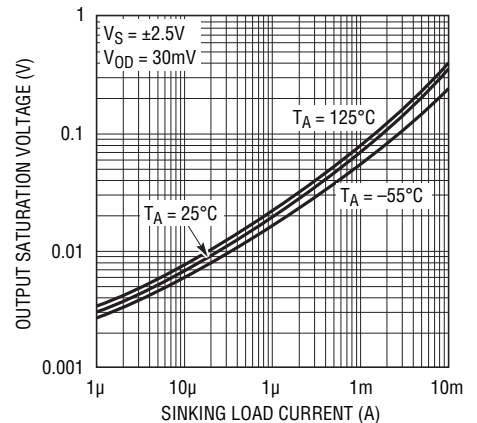

1782 G06

Output Saturation Voltage vs Input Overdrive

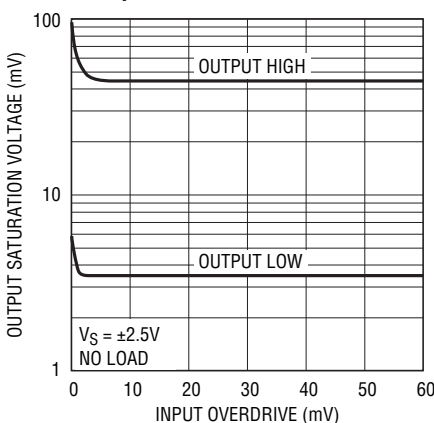

1782 G07

Output Short-Circuit Current vs Temperature

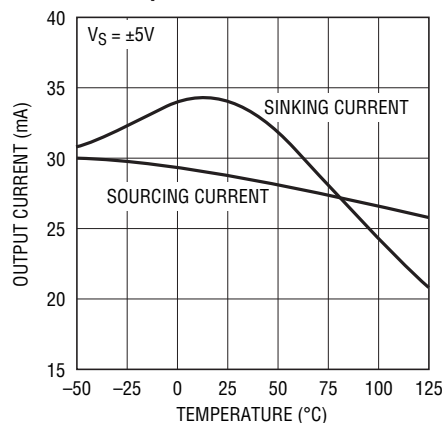

1782 G08

0.1Hz to 10Hz Noise Voltage

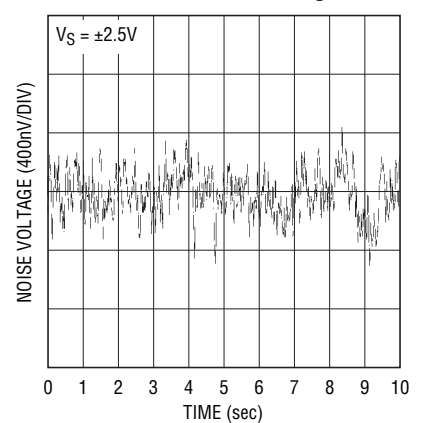

1782 G09

TYPICAL PERFORMANCE CHARACTERISTICS

Noise Voltage Density vs Frequency

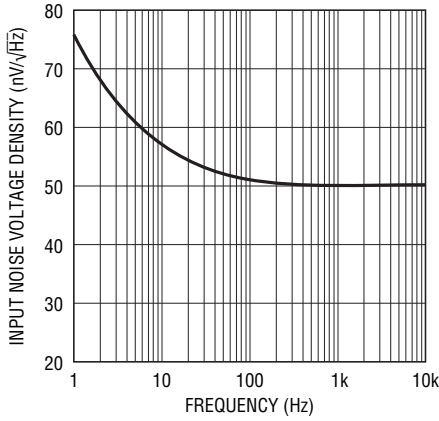

1782 G10

Input Noise Current vs Frequency

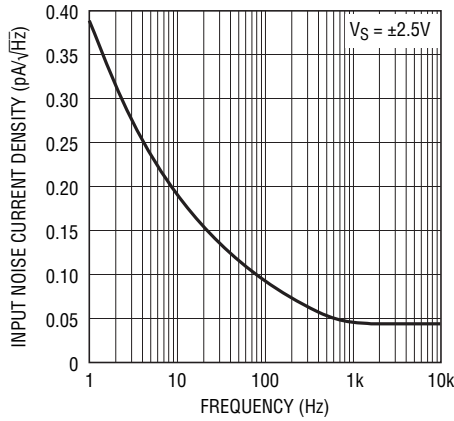

1782 G11

Gain and Phase Shift vs Frequency

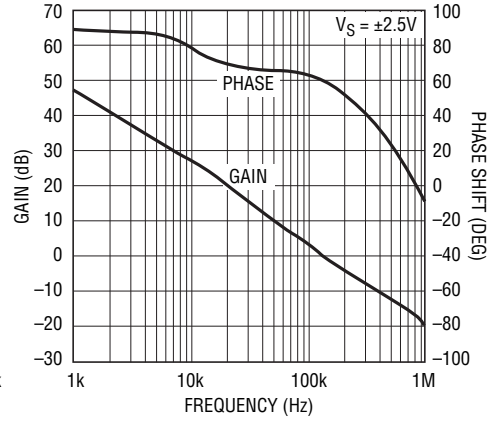

1782 G12

Gain Bandwidth Product vs Temperature

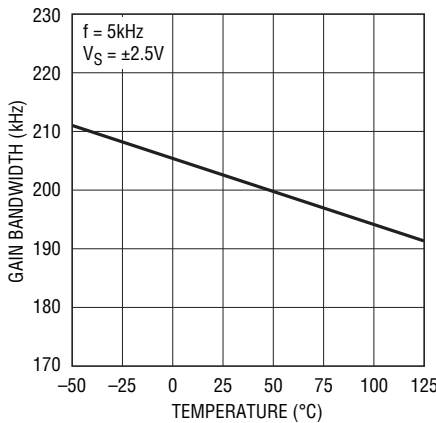

1782 G13

Slew Rate vs Temperature

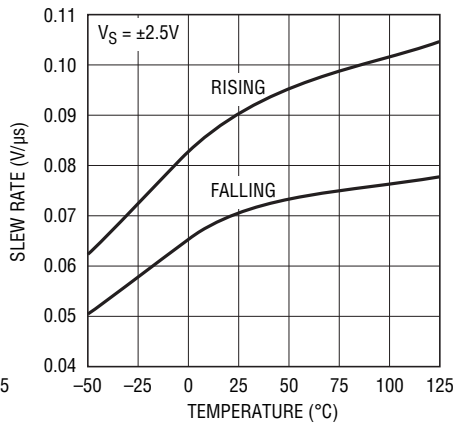

1782 G14

Gain Bandwidth Product and Phase Margin vs Supply Voltage

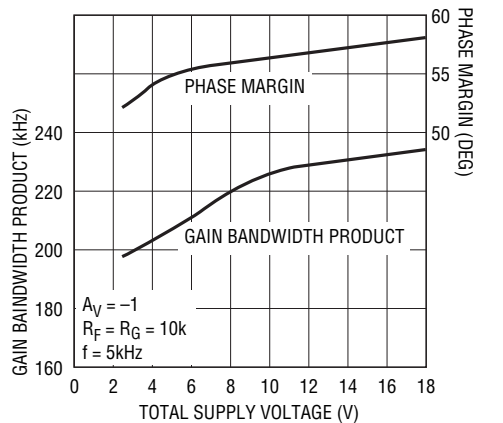

1782 G15

Gain Bandwidth Product and Phase Margin vs Load Resistance

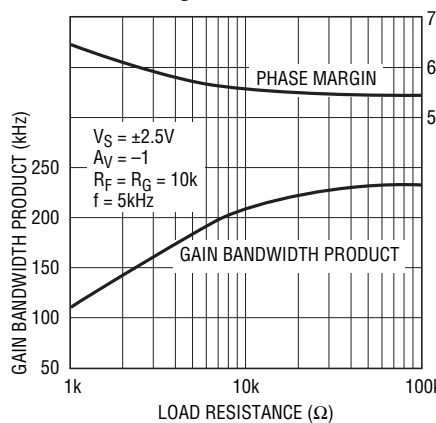

1782 G16

PSRR vs Frequency

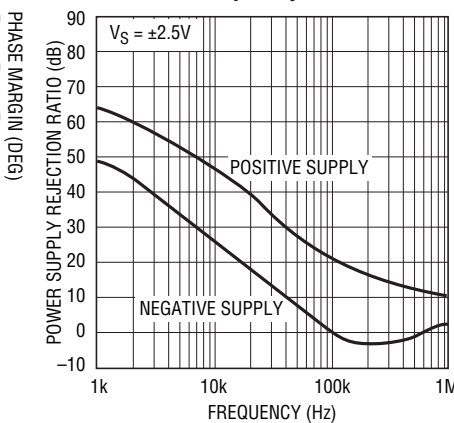

1782 G17

CMRR vs Frequency

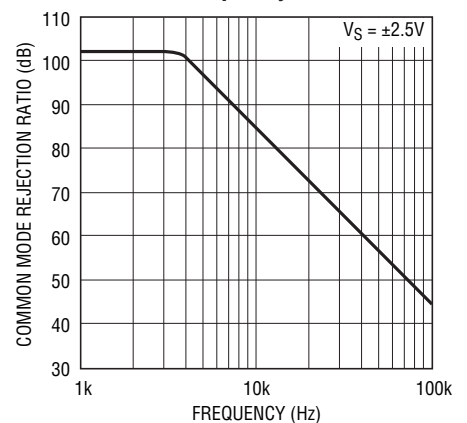

1782 G18

TYPICAL PERFORMANCE CHARACTERISTICS

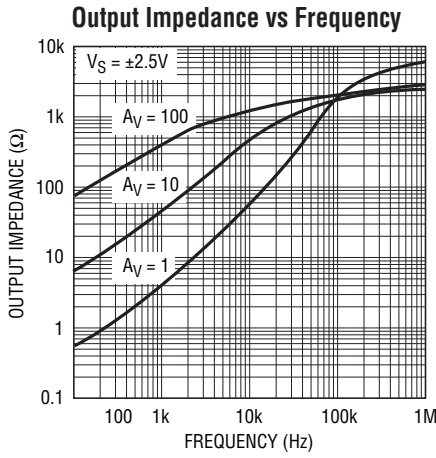

1782 G19

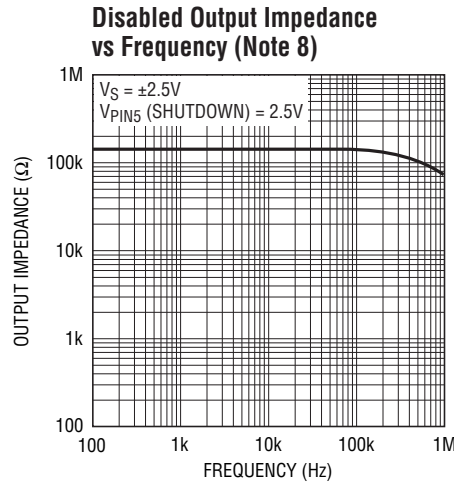

1782 G20

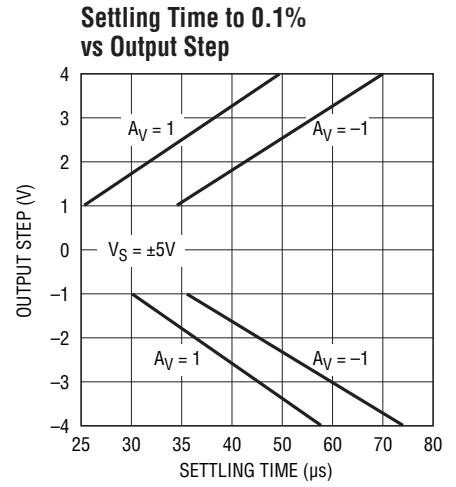

1782 G21

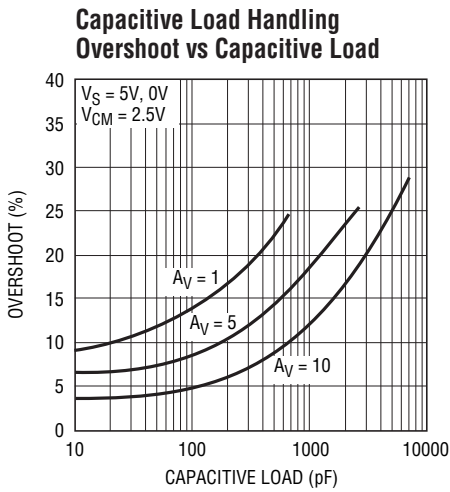

1782 G22

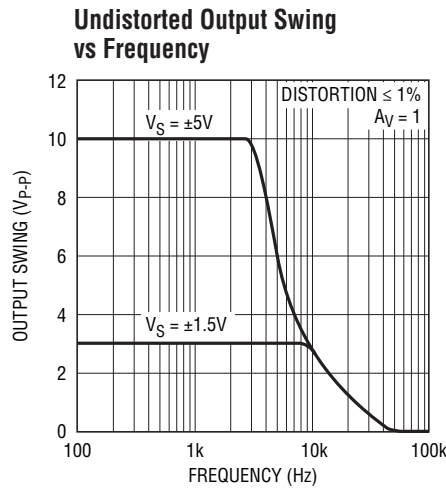

1782 G23

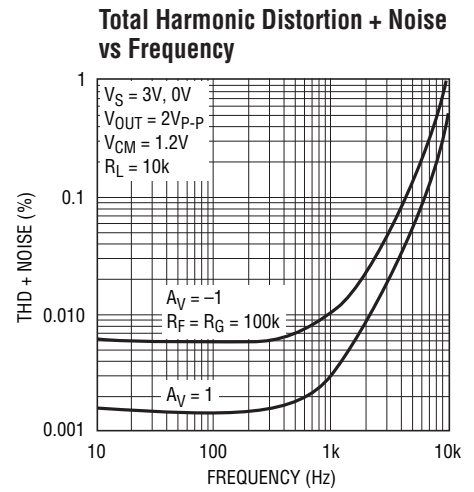

1782 G24

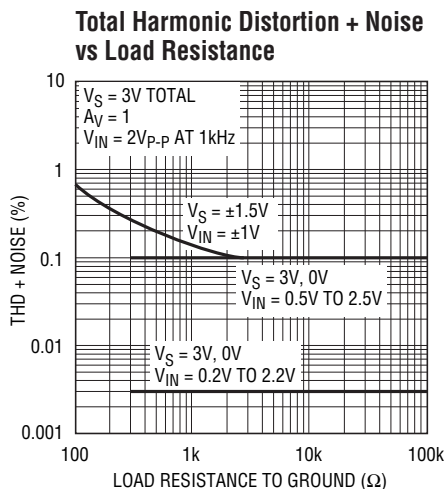

1782 G25

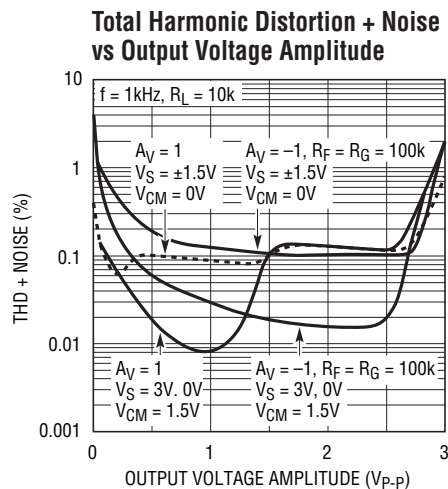

1782 G26

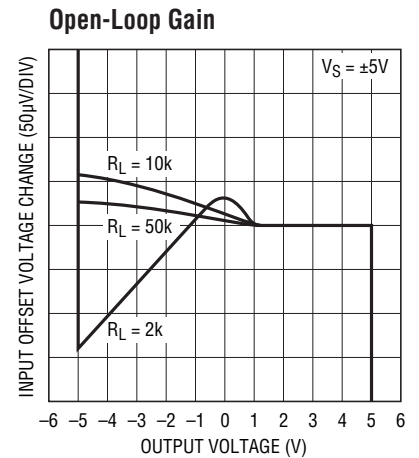

1782 G27

TYPICAL PERFORMANCE CHARACTERISTICS

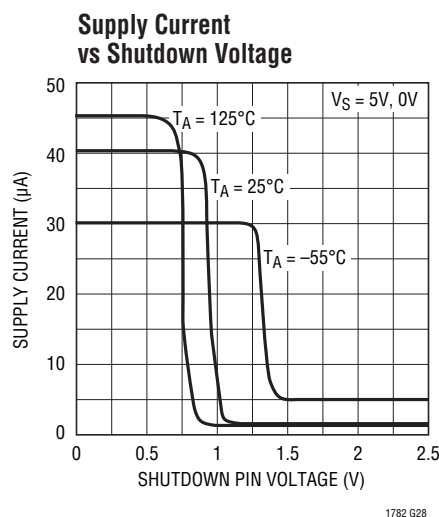

Large-Signal Response

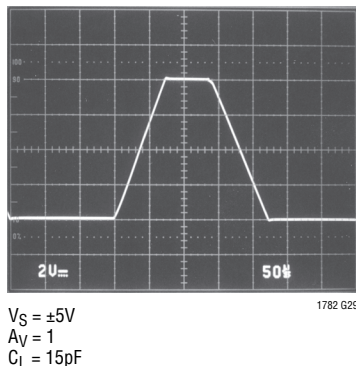

Small-Signal Response

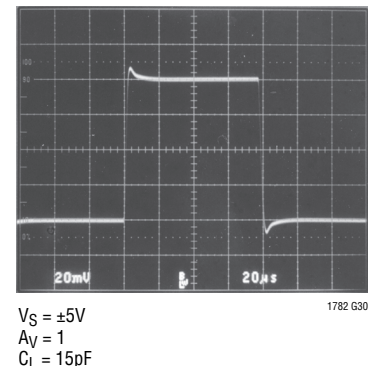

APPLICATIONS INFORMATION

Supply Voltage

The positive supply pin of the LT1782 should be bypassed with a small capacitor (typically 0.1µF) within an inch of the pin. When driving heavy loads, an additional 4.7µF electrolytic capacitor should be used. When using split supplies, the same is true for the negative supply pin.

The LT1782 is protected against reverse battery voltages up to 18V. In the event a reverse battery condition occurs, the supply current is typically less than 1nA.

Inputs

The LT1782 has two input stages, NPN and PNP (see the Simplified Schematic), resulting in three distinct operating regions as shown in the Input Bias Current vs Common Mode typical performance curve.

For input voltages about 0.8V or more below V^+ , the PNP input stage is active and the input bias current is typically $-8nA$. When the input common mode voltage is within 0.5V of the positive rail, the NPN stage is operating and the input bias current is typically 15nA. Increases in temperature will cause the voltage at which operation switches from the PNP input stage to the NPN input stage to move towards V^+ . The input offset voltage of the NPN stage is untrimmed and is typically 1.8mV.

A Schottky diode in the collector of the input NPN transistors, along with special geometries for these NPN transistors, allows the LT1782 to operate with either or both of its inputs above V^+ . At about 0.3V above V^+ , the NPN input transistor is fully saturated and the input bias current is typically 4µA at room temperature. The input offset voltage is typically 1.8mV when operating above V^+ . The LT1782 will operate with its inputs 18V above V^- regardless of V^+ .

The inputs are protected against excursions as much as 10V below V^- by an internal 6k resistor in series with each input and a diode from the input to the negative supply. The input stage of the LT1782 incorporates phase reversal protection to prevent the output from phase reversing for inputs up to 9V below V^- . There are no clamping diodes between the inputs and the maximum differential input voltage is 18V.

Output

The output of the LT1782 can swing to within 60mV of the positive rail with no load and within 3mV of the negative rail with no load. When monitoring voltages within 60mV of the positive rail or within 3mV of the negative rail, gain should be taken to keep the output from clipping. The LT1782 can sink and source over 30mA at $\pm 5V$ supplies,

APPLICATIONS INFORMATION

sourcing current is reduced to 10mA at 3V total supplies as noted in the Electrical Characteristics section.

The LT1782 is internally compensated to drive at least 600pF of capacitance under any output loading conditions. A 0.22μF capacitor in series with a 150Ω resistor between the output and ground will compensate these amplifiers for larger capacitive loads, up to 10,000pF, at all output currents.

Distortion

There are two main contributors to distortion in op amps: output crossover distortion as the output transitions from sourcing to sinking current, and distortion caused by non-linear common mode rejection. If the op amp is operating inverting, there is no common mode induced distortion. If the op amp is operating in the PNP input stage (input is not within 0.8V of V^+), the CMRR is very good, typically 100dB. When the LT1782 switches between input stages, there is significant nonlinearity in the CMRR. Lower load resistance increases the output crossover distortion but has no effect on the input stage transition distortion. For lowest distortion, the LT1782 should be operated single supply, with the output always sourcing current and with

the input voltage swing between ground and ($V^+ - 0.8V$). See the Typical Performance Characteristics curves, "Total Harmonic Distortion + Noise vs Output Voltage Amplitude."

Gain

The open-loop gain is almost independent of load when the output is sourcing current. This optimizes performance in single supply applications where the load is returned to ground. The typical performance curve of open-loop gain for various loads shows the details.

Shutdown

The 6-lead part includes a shutdown feature that disables the part, reducing quiescent current and making the output high impedance. The part can be shut down by bringing the SHDN pin 1.2V or more above V^- . When shut down, the supply current is about 5μA and the output leakage current is less than 1μA ($V^- \leq V_{OUT} \leq V^+$). In normal operation, the SHDN pin can be tied to V^- or left floating. See the Typical Performance Characteristics curves, "Supply Current vs Shutdown Pin Voltage."

SIMPLIFIED SCHEMATIC

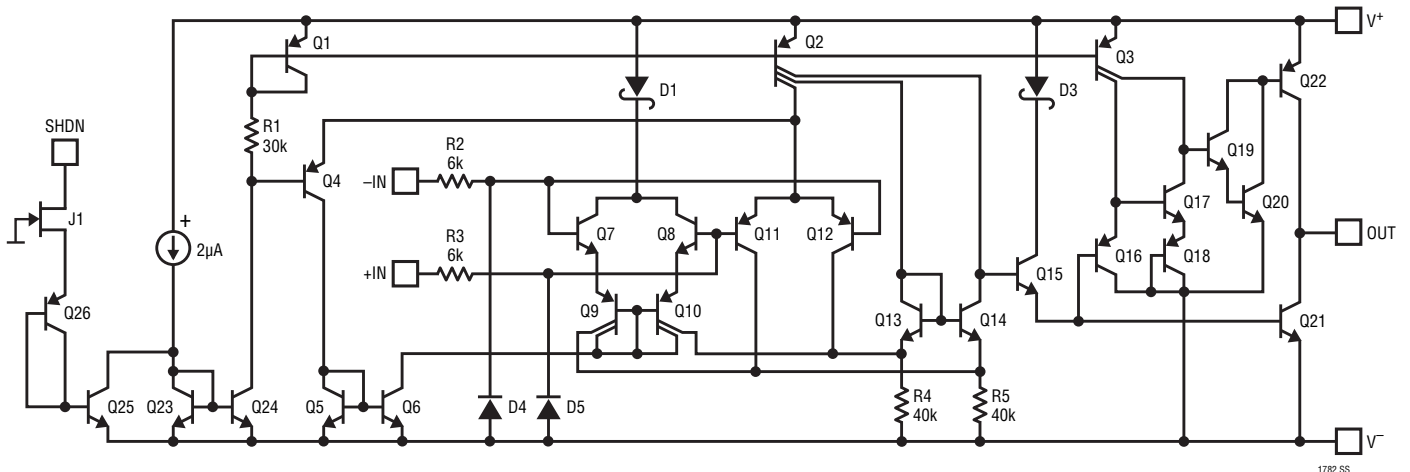

TYPICAL APPLICATIONS

Protected Fault Conditions

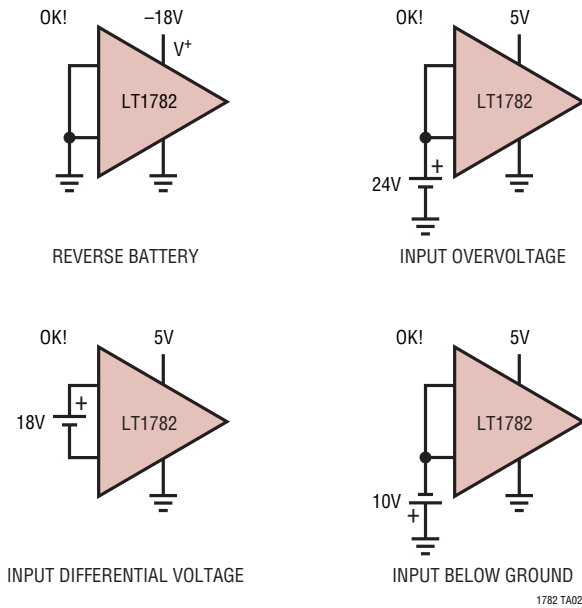

Compact, High Output Current, Low Dropout, Precision 2.5V Supply

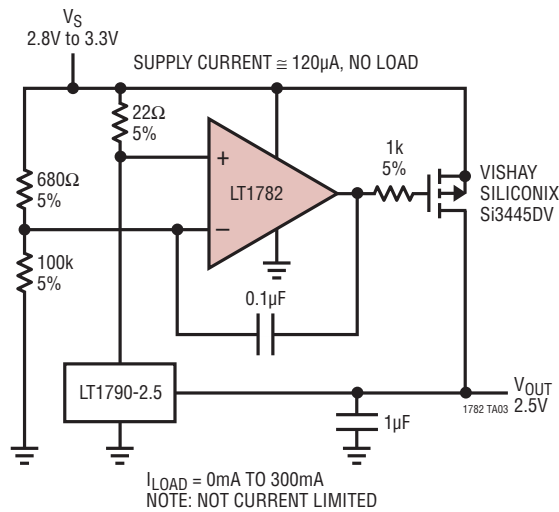

PACKAGE DESCRIPTION

S5 Package
5-Lead Plastic TSOT-23
 (Reference LTC DWG # 05-08-1635)

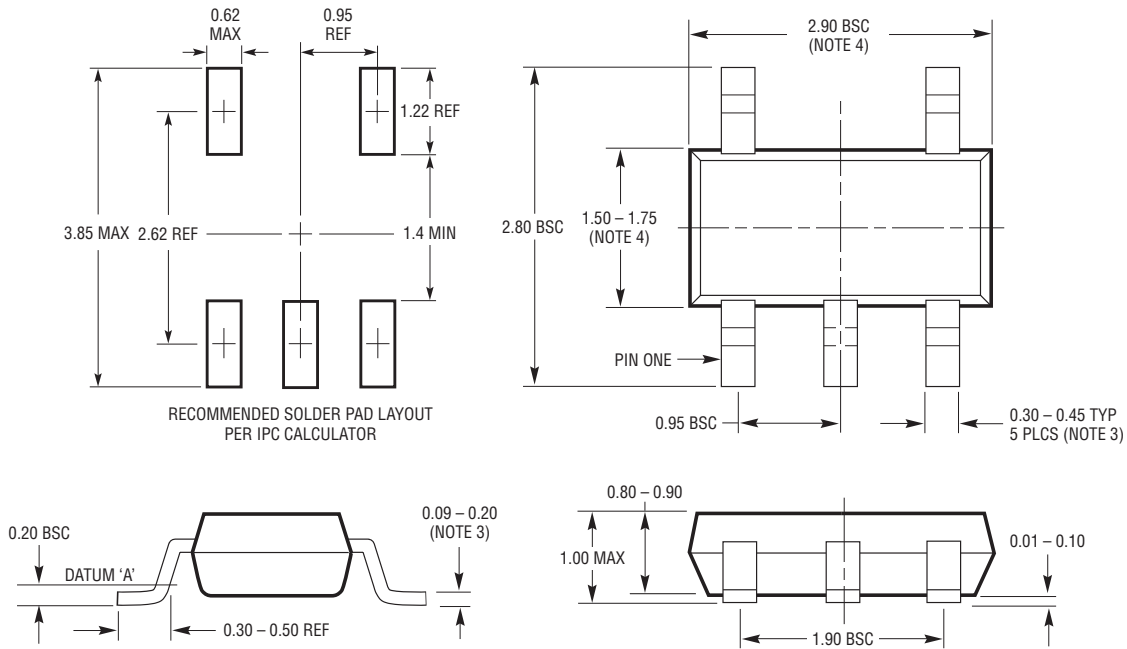

- NOTE:
- 1. DIMENSIONS ARE IN MILLIMETERS
 - 2. DRAWING NOT TO SCALE
 - 3. DIMENSIONS ARE INCLUSIVE OF PLATING
 - 4. DIMENSIONS ARE EXCLUSIVE OF MOLD FLASH AND METAL BURR
 - 5. MOLD FLASH SHALL NOT EXCEED 0.254mm
 - 6. JEDEC PACKAGE REFERENCE IS MO-193

SS TSOT-23 0302 REV B

S6 Package
6-Lead Plastic TSOT-23
 (Reference LTC DWG # 05-08-1636)

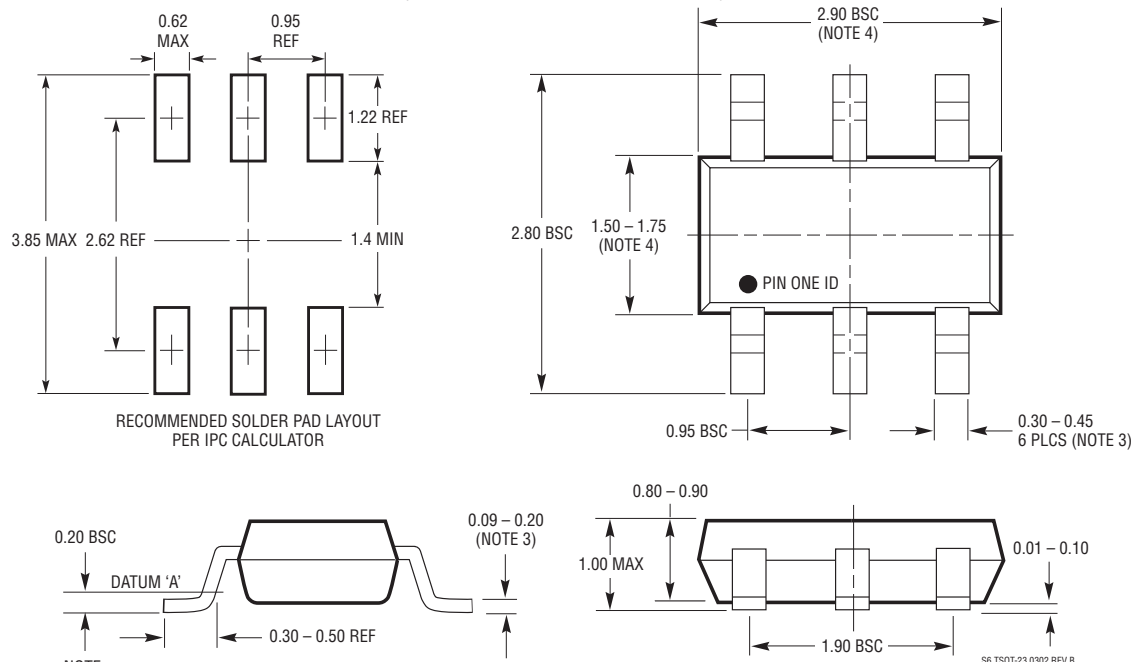

- NOTE:
- 1. DIMENSIONS ARE IN MILLIMETERS
 - 2. DRAWING NOT TO SCALE
 - 3. DIMENSIONS ARE INCLUSIVE OF PLATING
 - 4. DIMENSIONS ARE EXCLUSIVE OF MOLD FLASH AND METAL BURR
 - 5. MOLD FLASH SHALL NOT EXCEED 0.254mm
 - 6. JEDEC PACKAGE REFERENCE IS MO-193

S6 TSOT-23 0302 REV B

REVISION HISTORY (Revision history begins at Rev C)

REV	DATE	DESCRIPTION	PAGE NUMBER
C	10/10	Revised supply current in shutdown mode from 5mA to 5µA in Shutdown section of Applications Information	12

TYPICAL APPLICATIONS

Current Source

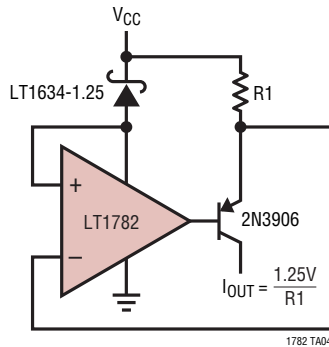

Programmable Gain, $A_V = 2$, $A_V = 20$, 100kHz Amplifier

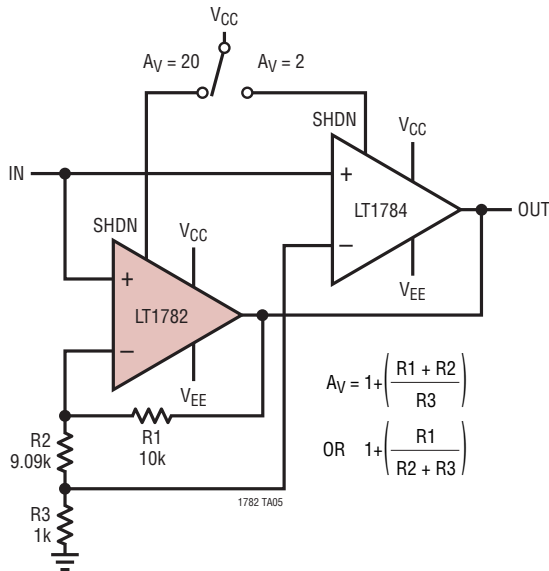

Programmable Gain Amplifier Frequency Response

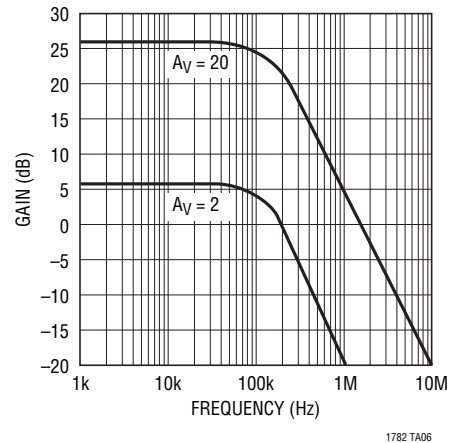

RELATED PARTS

PART NUMBER	DESCRIPTION	COMMENTS
LT1783	Micropower Over-The-Top SOT-23 Rail-to-Rail Input and Output Op Amp	SOT-23 Package, Micropower 210µA per Amplifier, Rail-to-Rail Input and Output, 1.25MHz GBW
LT1490/LT1491	Dual/Quad Over-The-Top Micropower Rail-to-Rail Input and Output Op Amps	Single Supply Input Range: -0.4V to 44V, Micropower 50µA per Amplifier, Rail-to-Rail Input and Output, 200kHz GBW
LT1636	Single Over-The-Top Micropower Rail-to-Rail Input and Output Op Amp	55µA Supply Current, V_{CM} Extends 44V Above V_{EE} , Independent of V_{CC} , MSOP Package, Shutdown Function
LT1638/LT1639	Dual/Quad, 1.2MHz, 0.4V/µs, Over-The-Top Micropower Rail-to-Rail Input and Output Op Amps	170mA Supply Current, Single Supply Input Range: -0.4V to 44V, Rail-to-Rail Input and Output

Mouser Electronics

Authorized Distributor

Click to View Pricing, Inventory, Delivery & Lifecycle Information:

[Analog Devices Inc.:](#)

[LT1782HS6#PBF](#) [LT1782IS5#TRMPBF](#) [LT1782IS6#PBF](#) [LT1782CS5#PBF](#) [LT1782IS6#TRM](#) [LT1782HS5#TRM](#)
[LT1782HS6#TR](#) [LT1782CS5#TRMPBF](#) [LT1782CS6#PBF](#) [LT1782IS5#TRPBF](#) [LT1782IS6#TRMPBF](#) [LT1782CS5#TR](#)
[LT1782HS5#TRMPBF](#) [LT1782HS6#TRM](#) [LT1782IS5#PBF](#) [LT1782CS5](#) [LT1782HS5](#) [LT1782CS6#TRMPBF](#)
[LT1782CS5#TRPBF](#) [LT1782CS6](#) [LT1782HS6#TRMPBF](#) [LT1782IS6#TRPBF](#) [LT1782IS5#TR](#) [LT1782IS5](#)
[LT1782IS5#TRM](#) [LT1782CS6#TRM](#) [LT1782HS5#TR](#) [LT1782HS6#TRPBF](#) [LT1782IS6](#) [LT1782IS6#TR](#)
[LT1782HS5#TRPBF](#) [LT1782CS5#TRM](#) [LT1782CS6#TR](#) [LT1782CS6#TRPBF](#) [LT1782HS6](#) [LT1782HS5#PBF](#)