

THIS DRAWING IS UNPUBLISHED. RELEASED FOR PUBLICATION
 © COPYRIGHT - By - ALL RIGHTS RESERVED.

REVISIONS				
P	LTR	DESCRIPTION	DATE	APVD
P1	ECR-16-004636		16-06-30	T.Q W.H

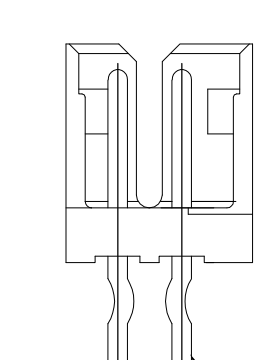
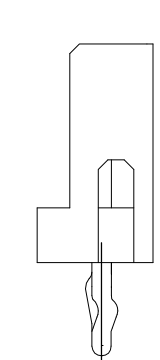
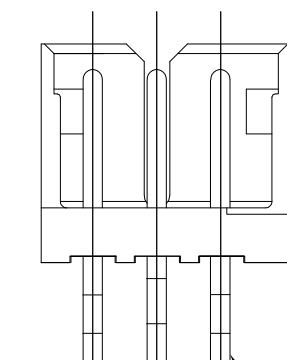
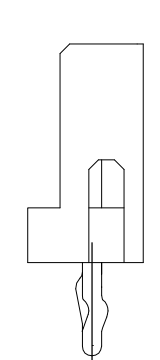
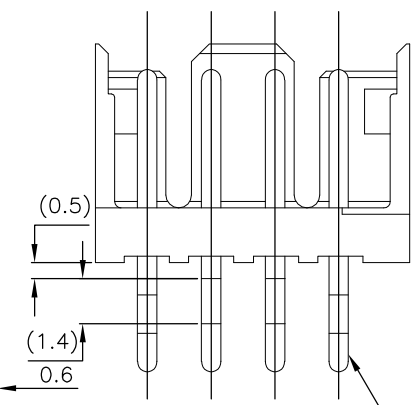
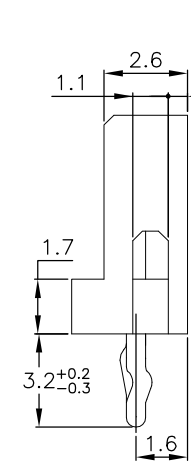
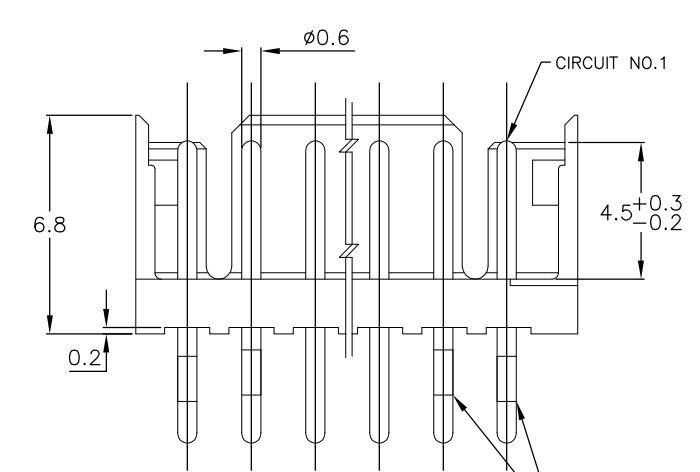
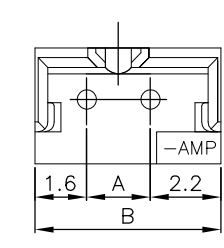
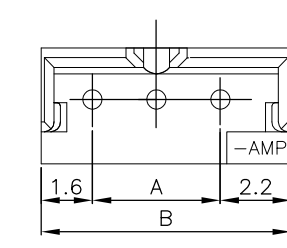
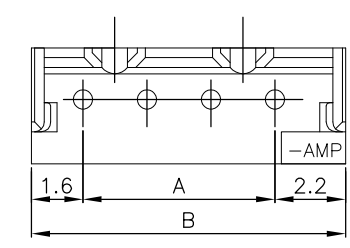
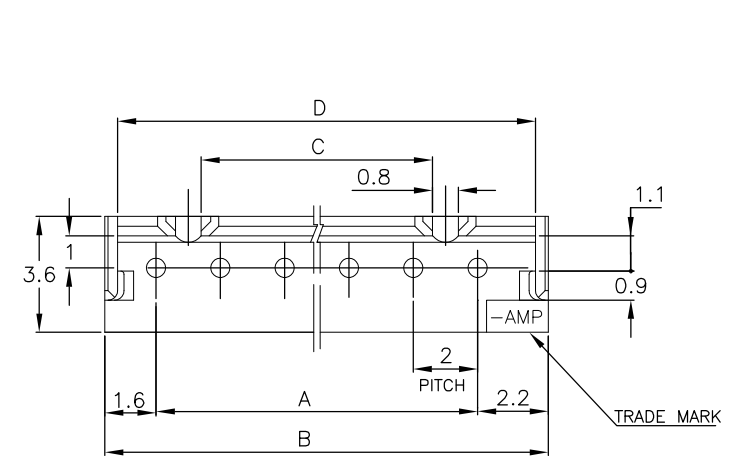

KINKING FORMING 4 PLACES
 KINKING FORMING 3 PLACES
 KINKING FORMING 2 PLACES
 4 POS.
 3 POS.
 2 POS.

	7-292161-5	5-292161-5	3-292161-5	1-292161-5	15	28	31.8	25.2	31.0
	7-4	5-4	3-4	1-4	14	26	29.8	23.2	29.0
	7-3	5-3	3-3	1-3	13	24	27.8	21.2	27.0
9-292161-2	7-2	5-2	3-2	1-2	12	22	25.8	19.2	25.0
9-1	7-1	5-1	3-1	1-1	11	20	23.8	17.2	23.0
9-0	7-0	5-0	3-0	1-0	10	18	21.8	15.2	21.0
8-9	6-9	4-9	2-9		9	16	19.8	13.2	19.0
8-8	6-8	4-8	2-8		8	14	17.8	11.2	17.0
8-7	6-7	4-7	2-7		7	12	15.8	9.2	15.0
8-6	6-6	4-6	2-6		6	10	13.8	7.2	13.0
8-5	6-5	4-5	2-5		5	8	11.8	5.2	11.0
8-4	6-4	4-4	2-4		4	6	9.8	3.2	9.0
8-3	6-3	4-3	2-3		3	4	7.8	—	7.0
8-292161-2	6-292161-2	4-292161-2	2-292161-2	292161-2	2	2	5.8	—	5.0
RED	BLACK	YELLOW	BLUE	NATURAL	Pos.	A	B	C	D

NOTES:
 1.MATERIAL: HOUSING - NYLON 66 (UL94V-0)
 POST - TIN BRASS
 2.APPLICABLE RECEPTACLE P/N 173977
 3.OBSOLETE RED COLOR PARTS.

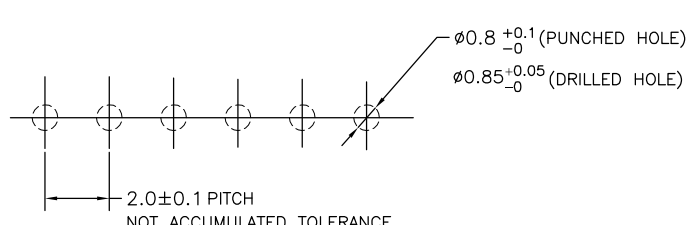

RECOMMENDABLE PCB LAYOUT
 (PCB THK:0.8-1.6)

TOLERANCES UNLESS OTHERWISE SPECIFIED:	
10 ≥ *	: ±0.2
30 ≥ * > 10	: ±0.25
100 ≥ * > 30	: ±0.3
ANGLE	: ±3°

THIS DRAWING IS A CONTROLLED DOCUMENT.

DWN S.XU 31JAN03
 CHK S.YAO 31JAN03
 APVD T. SASAKI 31JAN03

PRODUCT SPEC 108-60016
 APPLICATION SPEC

NAME POST HEADER ASS'Y VERTICAL TYPE (AMP CT CONNECTOR 2mm PITCH)

SIZE A3 CAGE CODE 00779 DRAWING NO C-292161 RESTRICTED TO —

MATERIAL SEE NOTE FINISH SEE NOTE WEIGHT 0.000000

CUSTOMER DRAWING SCALE 5:1 SHEET 1 OF 2 REV P1

THIS DRAWING IS UNPUBLISHED.

RELEASED FOR PUBLICATION

© COPYRIGHT - By -

ALL RIGHTS RESERVED.

REVISIONS

P	LTR	DESCRIPTION	DATE	DWN	APVD
-	-	SEE SHEET 1	-	-	-

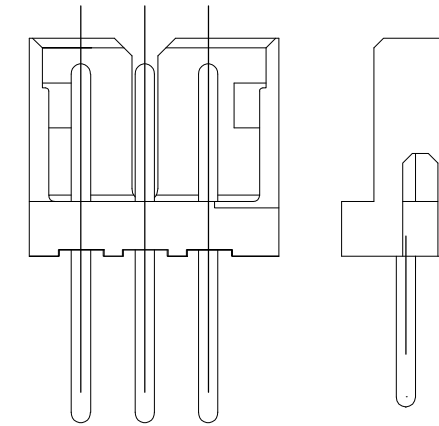
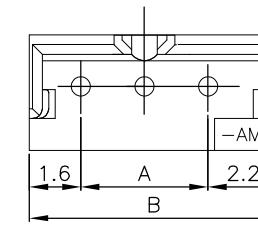
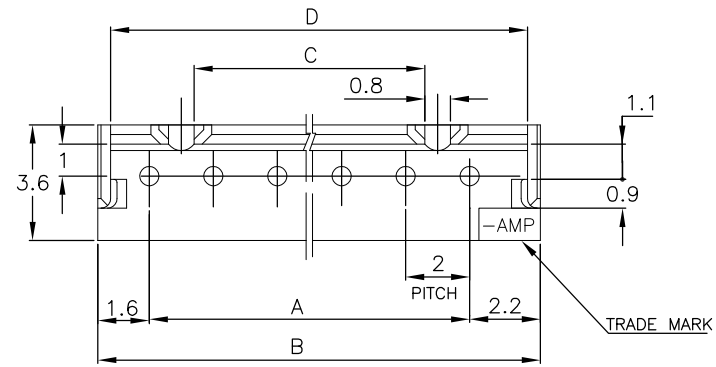

3 POS.

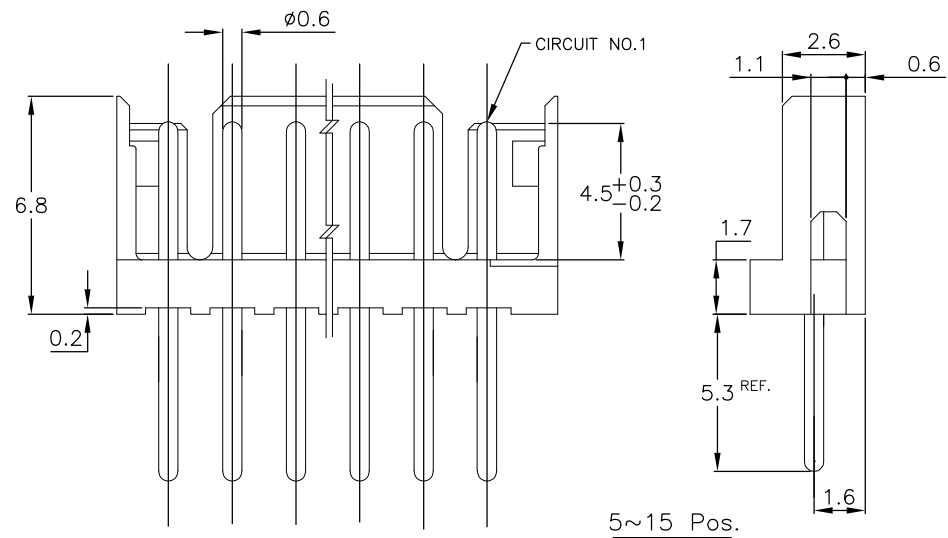

5~15 Pos.

NOTES:

- 1.MATERIAL: HOUSING - NYLON 66 (UL94V-0)
POST - TIN BRASS
- 2.APPLICABLE RECEPTACLE P/N 173977

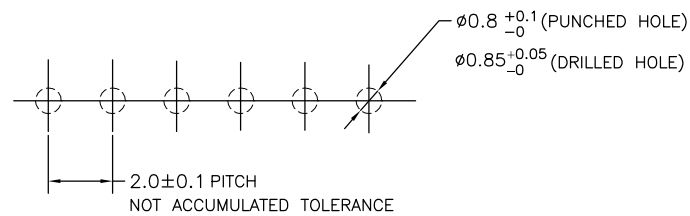

RECOMMENDABLE PCB LAYOUT (PCB THK:0.8-1.6)

TOLERANCES UNLESS OTHERWISE SPECIFIED:

- 10 ≥ * : ±0.2
- 30 ≥ * >10 : ±0.25
- 100 ≥ * >30 : ±0.3
- ANGLE : ±3°

9-292161-7	7	12	15.8	9.2	15.0
9-292161-3	3	4	7.8	-	7.0
NATURAL	Pos.	A	B	C	D
PART NO.					

THIS DRAWING IS A CONTROLLED DOCUMENT.		DWN S.XU 31JAN03	TE Connectivity POST HEADER ASS'Y VERTICAL TYPE (AMP CT CONNECTOR 2mm PITCH)		
DIMENSIONS: mm		CHK S.YAO 31JAN03			
TOLERANCES UNLESS OTHERWISE SPECIFIED:		APVD T. SASAKI 31JAN03			
		NAME			
MATERIAL SEE NOTE		FINISH SEE NOTE	PRODUCT SPEC 108-60016	RESTRICTED TO	
			APPLICATION SPEC	SIZE	CAGE CODE
			WEIGHT 0.000000	DRAWING NO	REV
			CUSTOMER DRAWING	A300779	C-292161
			SCALE 5:1	SHEET 2 of 2	P1

Mouser Electronics

Authorized Distributor

Click to View Pricing, Inventory, Delivery & Lifecycle Information:

[TE Connectivity:](#)

[4-292161-4](#)