



Is Now Part of



**ON Semiconductor®**

To learn more about ON Semiconductor, please visit our website at  
[www.onsemi.com](http://www.onsemi.com)

Please note: As part of the Fairchild Semiconductor integration, some of the Fairchild orderable part numbers will need to change in order to meet ON Semiconductor's system requirements. Since the ON Semiconductor product management systems do not have the ability to manage part nomenclature that utilizes an underscore (\_), the underscore (\_) in the Fairchild part numbers will be changed to a dash (-). This document may contain device numbers with an underscore (\_). Please check the ON Semiconductor website to verify the updated device numbers. The most current and up-to-date ordering information can be found at [www.onsemi.com](http://www.onsemi.com). Please email any questions regarding the system integration to [Fairchild\\_questions@onsemi.com](mailto:Fairchild_questions@onsemi.com).

ON Semiconductor and the ON Semiconductor logo are trademarks of Semiconductor Components Industries, LLC dba ON Semiconductor or its subsidiaries in the United States and/or other countries. ON Semiconductor owns the rights to a number of patents, trademarks, copyrights, trade secrets, and other intellectual property. A listing of ON Semiconductor's product/patent coverage may be accessed at [www.onsemi.com/site/pdf/Patent-Marking.pdf](http://www.onsemi.com/site/pdf/Patent-Marking.pdf). ON Semiconductor reserves the right to make changes without further notice to any products herein. ON Semiconductor makes no warranty, representation or guarantee regarding the suitability of its products for any particular purpose, nor does ON Semiconductor assume any liability arising out of the application or use of any product or circuit, and specifically disclaims any and all liability, including without limitation special, consequential or incidental damages. Buyer is responsible for its products and applications using ON Semiconductor products, including compliance with all laws, regulations and safety requirements or standards, regardless of any support or applications information provided by ON Semiconductor. "Typical" parameters which may be provided in ON Semiconductor data sheets and/or specifications can and do vary in different applications and actual performance may vary over time. All operating parameters, including "Typicals" must be validated for each customer application by customer's technical experts. ON Semiconductor does not convey any license under its patent rights nor the rights of others. ON Semiconductor products are not designed, intended, or authorized for use as a critical component in life support systems or any FDA Class 3 medical devices or medical devices with a same or similar classification in a foreign jurisdiction or any devices intended for implantation in the human body. Should Buyer purchase or use ON Semiconductor products for any such unintended or unauthorized application, Buyer shall indemnify and hold ON Semiconductor and its officers, employees, subsidiaries, affiliates, and distributors harmless against all claims, costs, damages, and expenses, and reasonable attorney fees arising out of, directly or indirectly, any claim of personal injury or death associated with such unintended or unauthorized use, even if such claim alleges that ON Semiconductor was negligent regarding the design or manufacture of the part. ON Semiconductor is an Equal Opportunity/Affirmative Action Employer. This literature is subject to all applicable copyright laws and is not for resale in any manner.

# FDS6990AS

## Dual 30V N-Channel PowerTrench® SyncFET™

### Features

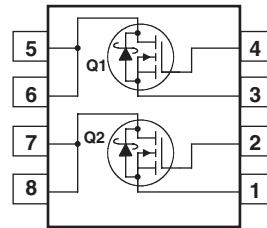
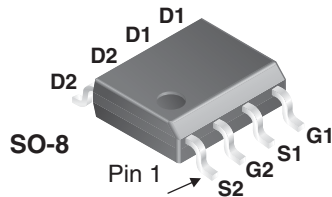
- 7.5 A, 30 V.  $R_{DS(ON)} = 22\text{ m}\Omega @ V_{GS} = 10\text{ V}$   
 $R_{DS(ON)} = 28\text{ m}\Omega @ V_{GS} = 4.5\text{ V}$
- Includes SyncFET Schottky diode
- Low gate charge (10nC typical)
- High performance trench technology for extremely low  $R_{DS(ON)}$
- High power and current handling capability

### General Description

The FDS6990AS is designed to replace a dual SO-8 MOSFET and two Schottky diodes in synchronous DC:DC power supplies. This 30V MOSFET is designed to maximize power conversion efficiency, providing a low  $R_{DS(ON)}$  and low gate charge. Each MOSFET includes integrated Schottky diodes using Fairchild's monolithic SyncFET technology. The performance of the FDS6990AS as the low-side switch in a synchronous rectifier is similar to the performance of the FDS6990A in parallel with a Schottky diode.

### Applications

- DC/DC converter
- Motor drives



### Absolute Maximum Ratings $T_A=25^\circ\text{C}$ unless otherwise noted

Symbol	Parameter	Ratings	Units	
$V_{DSS}$	Drain-Source Voltage	30	V	
$V_{GSS}$	Gate-Source Voltage	$\pm 20$	V	
$I_D$	Drain Current – Continuous (Note 1a)	7.5	A	
		20		
$P_D$	Power Dissipation for Dual Operation	2	W	
	Power Dissipation for Single Operation (Note 1a)	1.6		
		(Note 1b)		1
		(Note 1c)		0.9
$T_J, T_{STG}$	Operating and Storage Junction Temperature Range	-55 to +150	$^\circ\text{C}$	
<b>Thermal Characteristics</b>				
$R_{\theta JA}$	Thermal Resistance, Junction-to-Ambient (Note 1a)	78	$^\circ\text{C/W}$	
$R_{\theta JC}$	Thermal Resistance, Junction-to-Case (Note 1)	40	$^\circ\text{C/W}$	

### Package Marking and Ordering Information

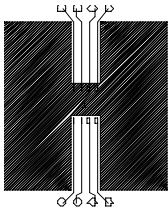
Device Marking	Device	Reel Size	Tape width	Quantity
FDS6990AS	FDS6990AS	13"	12mm	2500 units

**Electrical Characteristics**  $T_A = 25^\circ\text{C}$  unless otherwise noted

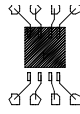
Symbol	Parameter	Test Conditions	Min	Typ	Max	Units
<b>Off Characteristics</b>						
$BV_{DSS}$	Drain–Source Breakdown Voltage	$V_{GS} = 0\text{ V}, I_D = 1\text{ mA}$	30			V
$\frac{\Delta BV_{DSS}}{\Delta T_J}$	Breakdown Voltage Temperature Coefficient	$I_D = 1\text{ mA}$ , Referenced to $25^\circ\text{C}$		31		$\text{mV}/^\circ\text{C}$
$I_{DSS}$	Zero Gate Voltage Drain Current	$V_{DS} = 24\text{ V}, V_{GS} = 0\text{ V}$			500	$\mu\text{A}$
$I_{GSS}$	Gate–Body Leakage	$V_{GS} = \pm 20\text{ V}, V_{DS} = 0\text{ V}$			$\pm 100$	nA
<b>On Characteristics (Note 2)</b>						
$V_{GS(th)}$	Gate Threshold Voltage	$V_{DS} = V_{GS}, I_D = 1\text{ mA}$	1	1.7	3	V
$\frac{\Delta V_{GS(th)}}{\Delta T_J}$	Gate Threshold Voltage Temperature Coefficient	$I_D = 1\text{ mA}$ , Referenced to $25^\circ\text{C}$		-3		$\text{mV}/^\circ\text{C}$
$R_{DS(on)}$	Static Drain–Source On–Resistance	$V_{GS} = 10\text{ V}, I_D = 7.5\text{ A}$ $V_{GS} = 10\text{ V}, I_D = 7.5\text{ A}, T_J = 125^\circ\text{C}$ $V_{GS} = 4.5\text{ V}, I_D = 6.5\text{ A}$		17 26 21	22 35 28	$\text{m}\Omega$
$I_{D(on)}$	On–State Drain Current	$V_{GS} = 10\text{ V}, V_{DS} = 5\text{ V}$	20			A
$g_{FS}$	Forward Transconductance	$V_{DS} = 15\text{ V}, I_D = 10\text{ A}$		29		S
<b>Dynamic Characteristics</b>						
$C_{iss}$	Input Capacitance	$V_{DS} = 15\text{ V}, V_{GS} = 0\text{ V}$ , $f = 1.0\text{ MHz}$		550		pF
$C_{oss}$	Output Capacitance			162		pF
$C_{rss}$	Reverse Transfer Capacitance			60		pF
$R_G$	Gate Resistance	$V_{GS} = 15\text{ mV}, f = 1.0\text{ MHz}$		3.1		$\Omega$
<b>Switching Characteristics (Note 2)</b>						
$t_{d(on)}$	Turn–On Delay Time	$V_{DS} = 15\text{ V}, I_D = 1\text{ A}$ , $V_{GS} = 10\text{ V}, R_{GEN} = 6\ \Omega$		8	16	ns
$t_r$	Turn–On Rise Time			5	10	ns
$t_{d(off)}$	Turn–Off Delay Time			24	38	ns
$t_f$	Turn–Off Fall Time			4	8	ns
$t_{d(on)}$	Turn–On Delay Time	$V_{DS} = 15\text{ V}, I_D = 1\text{ A}$ , $V_{GS} = 4.5\text{ V}, R_{GEN} = 6\ \Omega$		9	18	ns
$t_r$	Turn–On Rise Time			8	16	ns
$t_{d(off)}$	Turn–Off Delay Time			14	24	ns
$t_f$	Turn–Off Fall Time			5	10	ns
$Q_{g(TOT)}$	Total Gate Charge at $V_{GS} = 10\text{ V}$	$V_{DD} = 15\text{ V}, I_D = 10\text{ A}, V_{GS} = 5\text{ V}$		10	14	nC
$Q_g$	Total Gate Charge at $V_{GS} = 5\text{ V}$			6	8	nC
$Q_{gs}$	Gate–Source Charge			1.5		nC
$Q_{gd}$	Gate–Drain Charge			2.0		nC
<b>Drain–Source Diode Characteristics and Maximum Ratings</b>						
$I_S$	Maximum Continuous Drain–Source Diode Forward Current				2.9	A
$V_{SD}$	Drain–Source Diode Forward Voltage	$V_{GS} = 0\text{ V}, I_S = 2.3\text{ A}$ (Note 2)		0.6	0.7	V
$t_{rr}$	Diode Reverse Recovery Time	$I_F = 10\text{ A}$ ,		18		ns
$Q_{rr}$	Diode Reverse Recovery Charge	$dI_F/dt = 300\text{ A}/\mu\text{s}$ (Note 3)		11		nC

**Notes:**

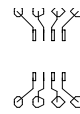
1.  $R_{\theta JA}$  is the sum of the junction-to-case and case-to-ambient thermal resistance where the case thermal reference is defined as the solder mounting surface of the drain pins.  $R_{\theta JC}$  is guaranteed by design while  $R_{\theta CA}$  is determined by the user's board design.



a) 78°C/W when mounted on a 0.5 in<sup>2</sup> pad of 2 oz copper



b) 125°C/W when mounted on a 0.02 in<sup>2</sup> pad of 2 oz copper



c) 135°C/W when mounted on a minimum pad.

Scale 1 : 1 on letter size paper

2. Pulse Test: Pulse Width < 300μs, Duty Cycle < 2.0%
3. See "SyncFET Schottky body diode characteristics" below.

## Typical Characteristics

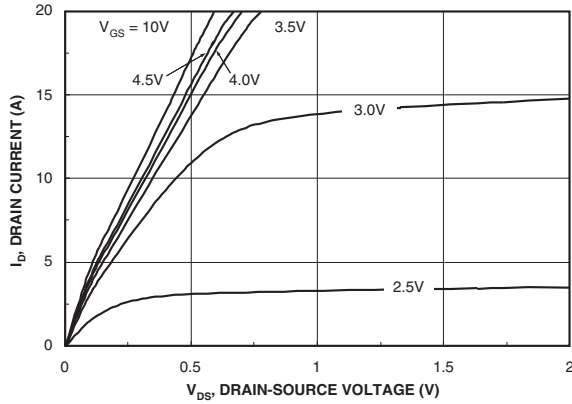


Figure 1. On-Region Characteristics.

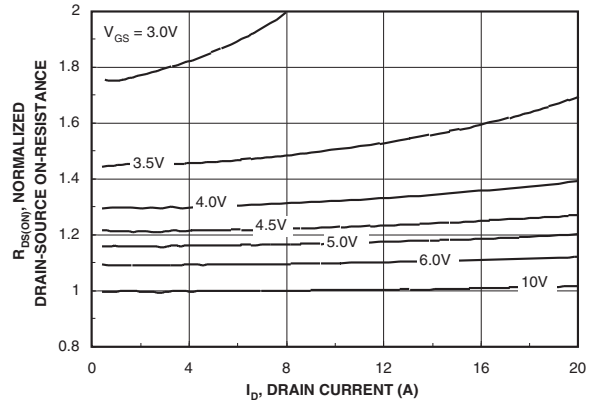


Figure 2. On-Resistance Variation with Drain Current and Gate Voltage.

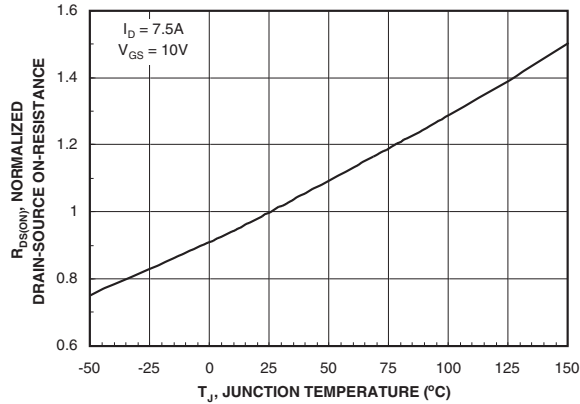


Figure 3. On-Resistance Variation with Temperature.

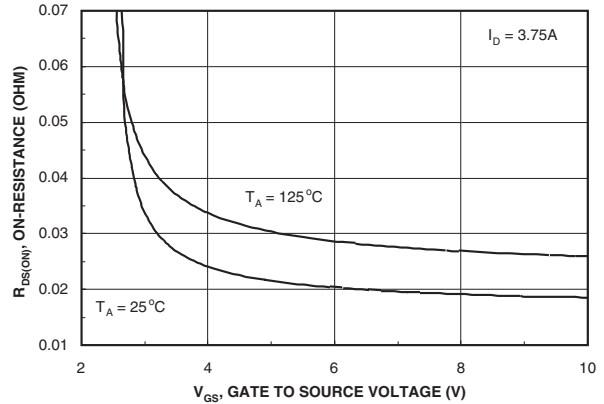


Figure 4. On-Resistance Variation with Gate-to-Source Voltage.

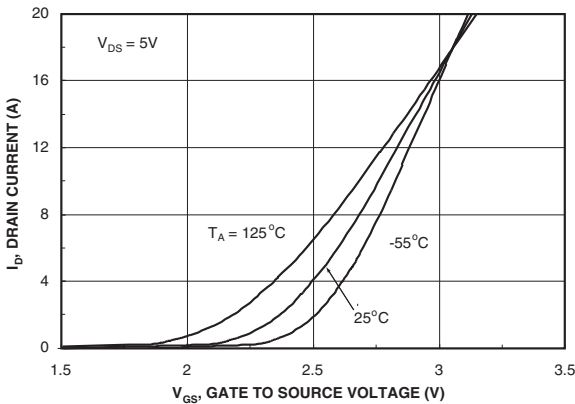


Figure 5. Transfer Characteristics.

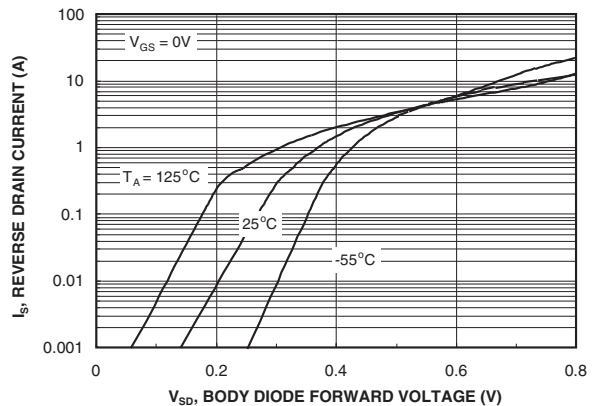


Figure 6. Body Diode Forward Voltage Variation with Source Current and Temperature.

## Typical Characteristics

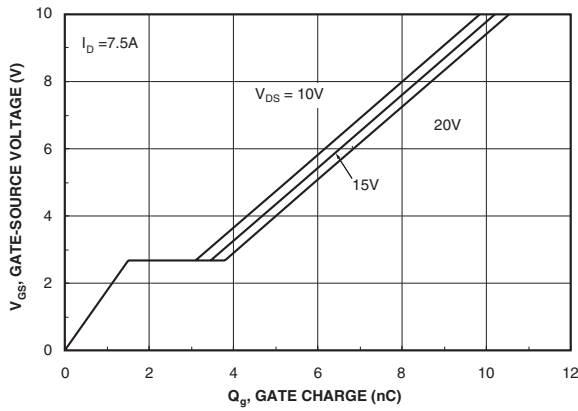


Figure 7. Gate Charge Characteristics.

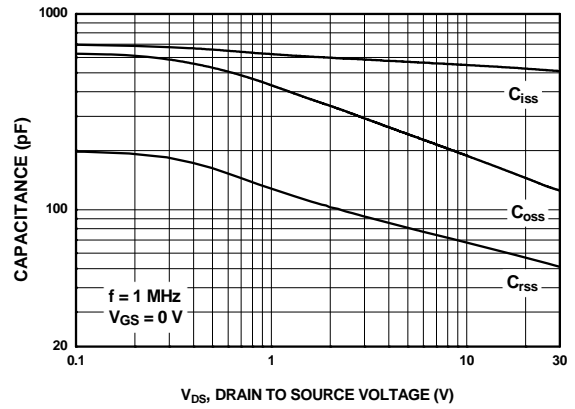


Figure 8. Capacitance Characteristics.

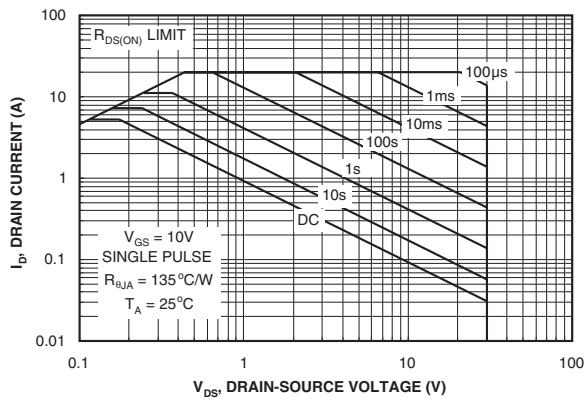


Figure 9. Maximum Safe Operating Area.

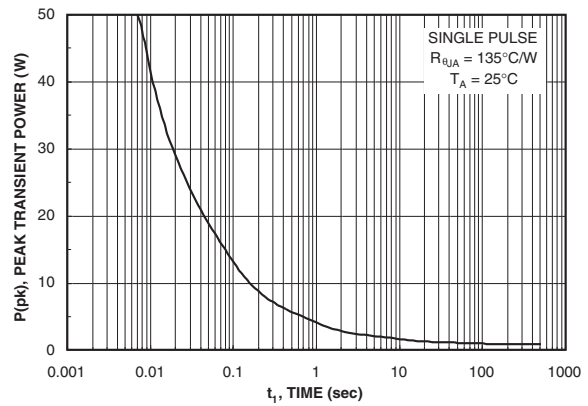


Figure 10. Single Pulse Maximum Power Dissipation.

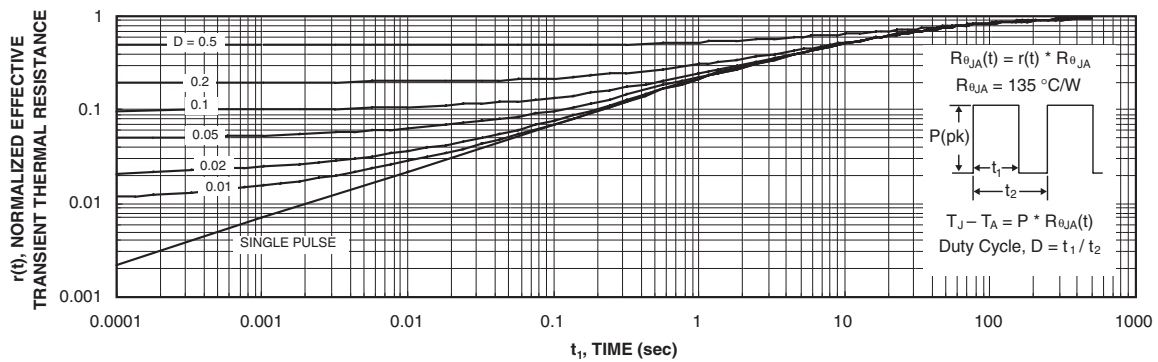


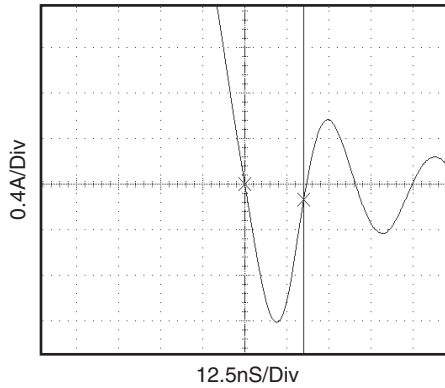
Figure 11. Transient Thermal Response Curve.

Thermal characterization performed using the conditions described in Note 1c. Transient thermal response will change depending on the circuit board design.

## Typical Characteristics (continued)

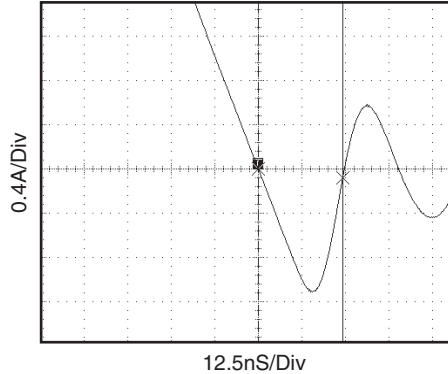
### SyncFET Schottky Body Diode Characteristics

Fairchild's SyncFET process embeds a Schottky diode in parallel with PowerTrench MOSFET. This diode exhibits similar characteristics to a discrete external Schottky diode in parallel with a MOSFET. Figure 12 shows the reverse recovery characteristic of the FDS6990AS.



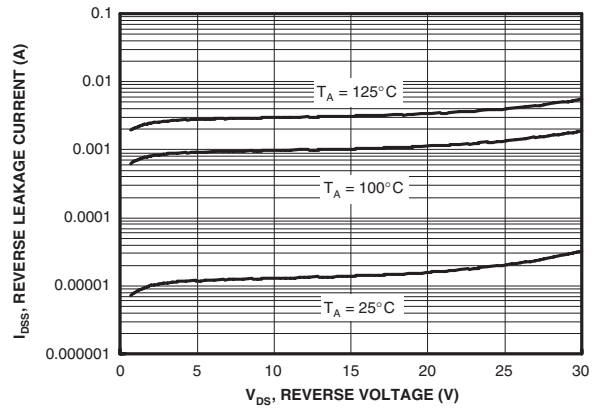
**Figure 12. FDS6990AS SyncFET body diode reverse recovery characteristic.**

For comparison purposes, Figure 13 shows the reverse recovery characteristics of the body diode of an equivalent size MOSFET produced without SyncFET (FDS6990A).



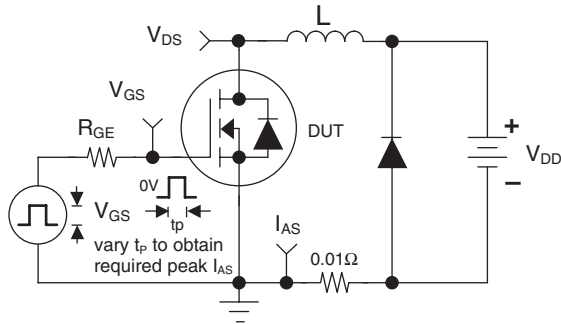
**Figure 13. Non-SyncFET (FDS6990A) body diode reverse recovery characteristic.**

Schottky barrier diodes exhibit significant leakage at high temperature and high reverse voltage. This will increase the power in the device.

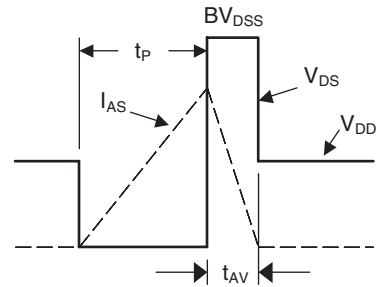


**Figure 14. SyncFET body diode reverse leakage versus drain-source voltage and temperature.**

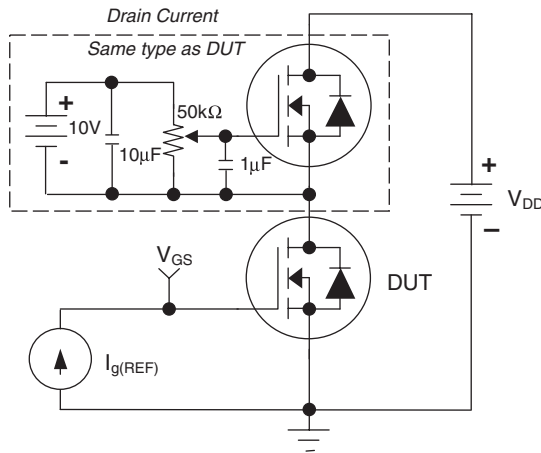
**Typical Characteristics** (continued)



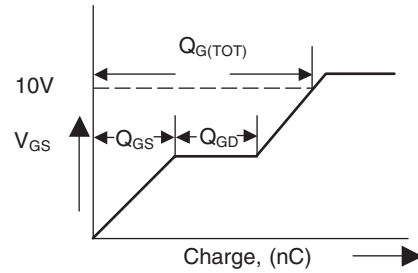
**Figure 15. Unclamped Inductive Load Test Circuit**



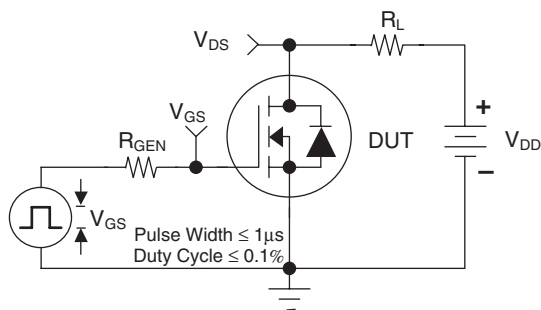
**Figure 16. Unclamped Inductive Waveforms**



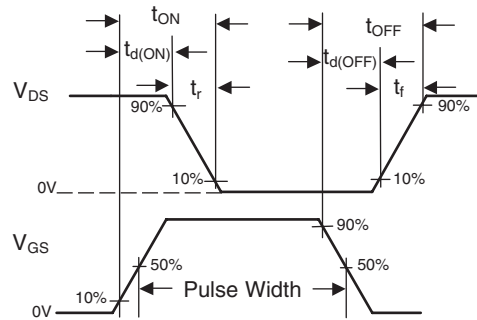
**Figure 17. Gate Charge Test Circuit**



**Figure 18. Gate Charge Waveform**



**Figure 19. Switching Time Test Circuit**







**Figure 20. Switching Time Waveforms**





**TRADEMARKS**

The following includes registered and unregistered trademarks and service marks, owned by Fairchild Semiconductor and/or its global subsidiaries, and is not intended to be an exhaustive list of all such trademarks.

- |  |  |   |   |
|--|--|---|---|
| AccuPower™   | FRFET®   | PowerTrench®  | The Power Franchise®  |
| Auto-SPM™  | Global Power Resource <sup>SM</sup>  | PowerXST™   | the power®  |
| Build it Now™  | Green FPST™  | Programmable Active Droop™  | franchise   |
| CorePLUS™  | Green FPST™ e-Series™  | QFET®   | TinyBoost™  |
| CorePOWER™   | Gmax™  | QS™   | TinyBuck™   |
| CROSSVOLT™   | GTO™   | Quiet Series™   | TinyCalc™   |
| CTL™   | IntelliMAX™  | RapidConfigure™   | TinyLogic®  |
| Current Transfer Logic™  | ISOPLANAR™   |  Saving our world, 1mW/W/kW at a time™ | TINYOPTO™   |
| DEUXPEED®  | MegaBuck™  | SignalWise™   | TinyPower™  |
| Dual Cool™   | MICROCOUPLER™  | SmartMax™   | TinyPWM™  |
| EcoSPARK®  | MicroFET™  | SMART START™  | TinyWire™   |
| EfficientMax™  | MicroPak™  | SPM®  | TriFault Detect™  |
|  Fairchild® | MicroPak2™   | STEALTH™  | TRUECURRENT™*   |
| Fairchild Semiconductor®   | MillerDrive™   | SuperFET™   | μSerDes™  |
| FACT Quiet Series™   | MotionMax™   | SuperSOT™_3   |  SerDes® |
| FACT®  | Motion-SPM™  | SuperSOT™_6   | UHC®  |
| FAST®  | OptiHiT™   | SuperSOT™_8   | Ultra FRFET™  |
| FastvCore™   | OPTOLOGIC®   | SupreMOS™   | UniFET™   |
| FETBench™  | OPTOPLANAR®  | SyncFET™  | VCX™  |
| FlashWriter® *   |  PDP SPM™ | Sync-Lock™  | VisualMax™  |
| FPS™   | Power-SPM™   |  SYSTEM®*                              | XST™  |
| F-PFS™   |  |   |   |

\*Trademarks of System General Corporation, used under license by Fairchild Semiconductor.

**DISCLAIMER**

FAIRCHILD SEMICONDUCTOR RESERVES THE RIGHT TO MAKE CHANGES WITHOUT FURTHER NOTICE TO ANY PRODUCTS HEREIN TO IMPROVE RELIABILITY, FUNCTION, OR DESIGN. FAIRCHILD DOES NOT ASSUME ANY LIABILITY ARISING OUT OF THE APPLICATION OR USE OF ANY PRODUCT OR CIRCUIT DESCRIBED HEREIN; NEITHER DOES IT CONVEY ANY LICENSE UNDER ITS PATENT RIGHTS, NOR THE RIGHTS OF OTHERS. THESE SPECIFICATIONS DO NOT EXPAND THE TERMS OF FAIRCHILD'S WORLDWIDE TERMS AND CONDITIONS, SPECIFICALLY THE WARRANTY THEREIN, WHICH COVERS THESE PRODUCTS.

**LIFE SUPPORT POLICY**

FAIRCHILD'S PRODUCTS ARE NOT AUTHORIZED FOR USE AS CRITICAL COMPONENTS IN LIFE SUPPORT DEVICES OR SYSTEMS WITHOUT THE EXPRESS WRITTEN APPROVAL OF FAIRCHILD SEMICONDUCTOR CORPORATION.

As used herein:

- Life support devices or systems are devices or systems which, (a) are intended for surgical implant into the body or (b) support or sustain life, and (c) whose failure to perform when properly used in accordance with instructions for use provided in the labeling, can be reasonably expected to result in a significant injury of the user.
- A critical component in any component of a life support, device, or system whose failure to perform can be reasonably expected to cause the failure of the life support device or system, or to affect its safety or effectiveness.

**ANTI-COUNTERFEITING POLICY**

Fairchild Semiconductor Corporation's Anti-Counterfeiting Policy. Fairchild's Anti-Counterfeiting Policy is also stated on our external website, [www.Fairchildsemi.com](http://www.Fairchildsemi.com), under Sales Support. Counterfeiting of semiconductor parts is a growing problem in the industry. All manufactures of semiconductor products are experiencing counterfeiting of their parts. Customers who inadvertently purchase counterfeit parts experience many problems such as loss of brand reputation, substandard performance, failed application, and increased cost of production and manufacturing delays. Fairchild is taking strong measures to protect ourselves and our customers from the proliferation of counterfeit parts. Fairchild strongly encourages customers to purchase Fairchild parts either directly from Fairchild or from Authorized Fairchild Distributors who are listed by country on our web page cited above. Products customers buy either from Fairchild directly or from Authorized Fairchild Distributors are genuine parts, have full traceability, meet Fairchild's quality standards for handling and storage and provide access to Fairchild's full range of up-to-date technical and product information. Fairchild and our Authorized Distributors will stand behind all warranties and will appropriately address and warranty issues that may arise. Fairchild will not provide any warranty coverage or other assistance for parts bought from Unauthorized Sources. Fairchild is committed to combat this global problem and encourage our customers to do their part in stopping this practice by buying direct or from authorized distributors.

**PRODUCT STATUS DEFINITIONS**  
Definition of Terms

Datasheet Identification	Product Status	Definition
Advance Information	Formative / In Design	Datasheet contains the design specifications for product development. Specifications may change in any manner without notice.
Preliminary	First Production	Datasheet contains preliminary data; supplementary data will be published at a later date. Fairchild Semiconductor reserves the right to make changes at any time without notice to improve design.
No Identification Needed	Full Production	Datasheet contains final specifications. Fairchild Semiconductor reserves the right to make changes at any time without notice to improve the design.
Obsolete	Not In Production	Datasheet contains specifications on a product that is discontinued by Fairchild Semiconductor. The datasheet is for reference information only.

ON Semiconductor and  are trademarks of Semiconductor Components Industries, LLC dba ON Semiconductor or its subsidiaries in the United States and/or other countries. ON Semiconductor owns the rights to a number of patents, trademarks, copyrights, trade secrets, and other intellectual property. A listing of ON Semiconductor's product/patent coverage may be accessed at [www.onsemi.com/site/pdf/Patent-Marking.pdf](http://www.onsemi.com/site/pdf/Patent-Marking.pdf). ON Semiconductor reserves the right to make changes without further notice to any products herein. ON Semiconductor makes no warranty, representation or guarantee regarding the suitability of its products for any particular purpose, nor does ON Semiconductor assume any liability arising out of the application or use of any product or circuit, and specifically disclaims any and all liability, including without limitation special, consequential or incidental damages. Buyer is responsible for its products and applications using ON Semiconductor products, including compliance with all laws, regulations and safety requirements or standards, regardless of any support or applications information provided by ON Semiconductor. "Typical" parameters which may be provided in ON Semiconductor data sheets and/or specifications can and do vary in different applications and actual performance may vary over time. All operating parameters, including "Typicals" must be validated for each customer application by customer's technical experts. ON Semiconductor does not convey any license under its patent rights nor the rights of others. ON Semiconductor products are not designed, intended, or authorized for use as a critical component in life support systems or any FDA Class 3 medical devices or medical devices with a same or similar classification in a foreign jurisdiction or any devices intended for implantation in the human body. Should Buyer purchase or use ON Semiconductor products for any such unintended or unauthorized application, Buyer shall indemnify and hold ON Semiconductor and its officers, employees, subsidiaries, affiliates, and distributors harmless against all claims, costs, damages, and expenses, and reasonable attorney fees arising out of, directly or indirectly, any claim of personal injury or death associated with such unintended or unauthorized use, even if such claim alleges that ON Semiconductor was negligent regarding the design or manufacture of the part. ON Semiconductor is an Equal Opportunity/Affirmative Action Employer. This literature is subject to all applicable copyright laws and is not for resale in any manner.

## PUBLICATION ORDERING INFORMATION

### LITERATURE FULFILLMENT:

Literature Distribution Center for ON Semiconductor  
19521 E. 32nd Pkwy, Aurora, Colorado 80011 USA  
**Phone:** 303-675-2175 or 800-344-3860 Toll Free USA/Canada  
**Fax:** 303-675-2176 or 800-344-3867 Toll Free USA/Canada  
**Email:** [orderlit@onsemi.com](mailto:orderlit@onsemi.com)

**N. American Technical Support:** 800-282-9855 Toll Free  
USA/Canada  
**Europe, Middle East and Africa Technical Support:**  
Phone: 421 33 790 2910  
**Japan Customer Focus Center**  
Phone: 81-3-5817-1050

**ON Semiconductor Website:** [www.onsemi.com](http://www.onsemi.com)  
**Order Literature:** <http://www.onsemi.com/orderlit>  
For additional information, please contact your local  
Sales Representative

# Mouser Electronics

Authorized Distributor

Click to View Pricing, Inventory, Delivery & Lifecycle Information:

[ON Semiconductor:](#)

[FDS6990AS](#)