

CZRB3005-G Thru CZRB3200-G

Voltage: 6.2 to 200 Volts

Power: 3 Watts

RoHS Device

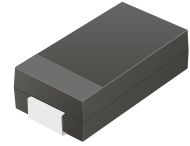

Features

- Glass passivated chip
- Low leakage
- Built-in strain relief
- Low inductance
- High peak reverse power dissipation
- For use in stabilizing and clipping with high power rating.

Mechanical data

- Epoxy: UL 94V-0 rate flame retardant
- Case: DO-214AA(SMB),Molded plastic,
- Lead: Solderable per MIL-STD-750, method 2026 guaranteed.
- Polarity: Color band denotes cathode end.
- Mounting position: Any
- Weight: 0.1 grams

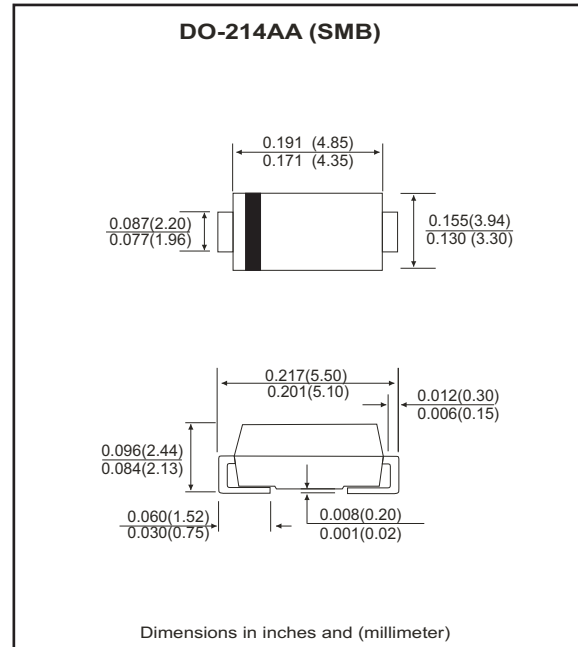

Ratings AND Electrical Characteristics

Parameter	Symbol	Value	Unit
Forward Voltage Drop at $I_F = 200 \text{ mA}$	V_F	1.5	V
DC Power Dissipation at $T_L = 50^\circ\text{C}$ (Note 1)	P_D	3	W
Junction temperature range	T_J	-55 to +150	$^\circ\text{C}$
Storage temperature range	T_{STG}	-55 to +150	$^\circ\text{C}$

(1) T_L = Lead temperature at 3/8" (9.5mm) from body.

Electrical Characteristics(Ta = 25°C)

Part Number	Nominal Zener Voltage		Maximum Zener Impedance			Maximum Reverse Leakage Current		Maximum DC Zener Current	Marking Code
	VZ @ IZT	IZT	ZZT @ IZT	ZZK @ IZK	IZK	IR @ VR		IZM	
	(V)	(mA)	(Ohm)	(Ohm)	(mA)	(uA)	(V)	(mA)	
CZRB3005-G	6.2	121.0	1.5	700	1.0	50.0	3.0	435	3A0
CZRB3006-G	6.8	110.0	2.0	700	1.0	50.0	4.0	393	3A1
CZRB3007-G	7.5	100.0	2.0	700	0.5	50.0	5.0	360	3A2
CZRB3008-G	8.2	91.0	2.3	700	0.5	50.0	6.0	330	3A3
CZRB3009-G	9.1	82.0	2.4	700	0.5	50.0	7.0	297	3A4
CZRB3010-G	10.0	75.0	3.5	700	0.25	50.0	7.6	270	3A5
CZRB3011-G	11.0	68.0	4.0	700	0.25	50.0	8.4	225	3A6
CZRB3012-G	12.0	63.0	4.5	700	0.25	1.0	9.1	246	3A7
CZRB3013-G	13.0	58.0	4.5	700	0.25	0.5	9.9	208	3A8
CZRB3014-G	14.0	53.0	5.0	700	0.25	0.5	10.6	193	3A9
CZRB3015-G	15.0	50.0	5.5	700	0.25	0.5	11.4	180	3B0
CZRB3016-G	16.0	47.0	5.5	700	0.25	0.5	12.2	169	3B1
CZRB3017-G	17.0	44.0	6.0	750	0.25	0.5	13.0	159	3B2
CZRB3018-G	18.0	42.0	6.0	750	0.25	0.5	13.7	150	3B3
CZRB3019-G	19.0	40.0	7.0	750	0.25	0.5	14.4	142	3B4
CZRB3020-G	20.0	37.0	7.0	750	0.25	0.5	15.2	135	3B5
CZRB3022-G	22.0	34.0	8.0	750	0.25	0.5	16.7	123	3B6
CZRB3024-G	24.0	31.0	9.0	750	0.25	0.5	18.2	112	3B7
CZRB3027-G	27.0	28.0	10.0	750	0.25	0.5	20.6	100	3B8
CZRB3028-G	28.0	27.0	12.0	750	0.25	0.5	21.0	96	3B9
CZRB3030-G	30.0	25.0	16.0	1000	0.25	0.5	22.5	90	3C0
CZRB3033-G	33.0	23.0	20.0	1000	0.25	0.5	25.1	82	3C1
CZRB3036-G	36.0	21.0	22.0	1000	0.25	0.5	27.4	75	3C2
CZRB3039-G	39.0	19.0	28.0	1000	0.25	0.5	29.7	69	3C3
CZRB3043-G	43.0	17.0	33.0	1500	0.25	0.5	32.7	63	3C4
CZRB3047-G	47.0	16.0	38.0	1500	0.25	0.5	35.6	57	3C5
CZRB3051-G	51.0	15.0	45.0	1500	0.25	0.5	38.8	53	3C6
CZRB3056-G	56.0	13.0	50.0	2000	0.25	0.5	42.6	48	3C7
CZRB3062-G	62.0	12.0	55.0	2000	0.25	0.5	47.1	44	3C8
CZRB3068-G	68.0	11.0	70.0	2000	0.25	0.5	51.7	40	3C9
CZRB3075-G	75.0	10.0	85.0	2000	0.25	0.5	56.0	36	3F0
CZRB3082-G	82.0	9.1	95.0	3000	0.25	0.5	62.2	33	3F1
CZRB3091-G	91.0	8.2	115.0	3000	0.25	0.5	69.2	30	3F2
CZRB3100-G	100.0	7.5	160.0	3000	0.25	0.5	76.0	27	3F3

Notes:

- (1) The type number listed have a standard tolerance on th nominal zener voltage of $\pm 5\%$.
- (2) The reverse surge current is a non-repetitive,8.3ms pulse width square wave or equivalent sine-wave superimposed on IZT per JEDEC Method.

Electrical Characteristics(Ta = 25°C)

Part Number	Nominal Zener Voltage		Maximum Zener Impedance			Maximum Reverse Leakage Current		Maximum DC Zener Current	Marking Code
	VZ @ IZT	IZT	ZZT @ IZT	ZZK @ IZK	IZK	IR @ VR		IZM	
	(V)	(mA)	(Ohm)	(Ohm)	(mA)	(uA)	(V)	(mA)	
CZRB3110-G	110.0	6.8	225.0	4000	0.25	0.5	83.6	25	3F4
CZRB3120-G	120.0	6.3	300.0	4500	0.25	0.5	91.2	22	3F5
CZRB3130-G	130.0	5.8	375.0	5000	0.25	0.5	98.8	21	3F6
CZRB3140-G	140.0	5.3	475.0	5000	0.25	0.5	106.4	19	3F7
CZRB3150-G	150.0	5.0	550.0	6000	0.25	0.5	114.0	18	3F8
CZRB3160-G	160.0	4.7	625.0	6500	0.25	0.5	121.6	17	3F9
CZRB3170-G	170.0	4.4	650.0	7000	0.25	0.5	130.4	16	3G1
CZRB3180-G	180.0	4.2	700.0	7000	0.25	0.5	136.8	15	3G2
CZRB3190-G	190.0	4.0	800.0	8000	0.25	0.5	144.8	14	3G3
CZRB3200-G	200.0	3.7	875.0	8000	0.25	0.5	152.0	13	3G4

Notes:

- (1) The type number listed have a standard tolerance on th nominal zener voltage of $\pm 5\%$.
- (2) The reverse surge current is a non-repetitive,8.3ms pulse width square wave or equivalent sine-wave superimposed on IZT per JEDEC Method.

RATING AND CHARACTERISTIC CURVES (CZRB3005-G Thru CZRB3200B-G)

Fig.1 Power temperature derating current

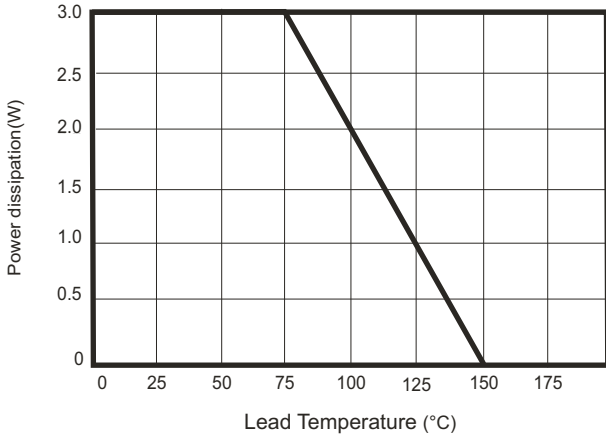

Fig.2 Temperature Coefficients v.s. Zener Voltage

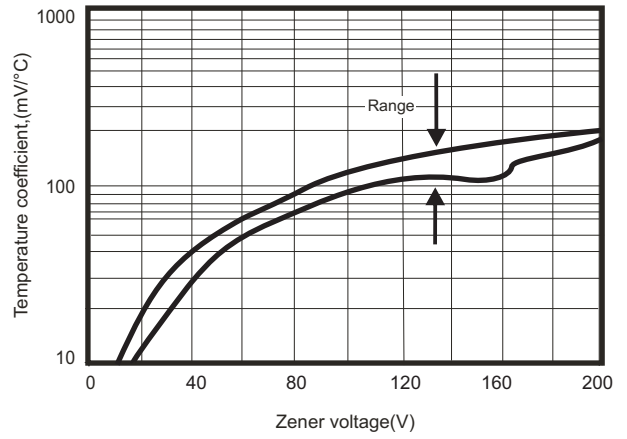

Fig.3 Typical thermal resistance v.s. lead length

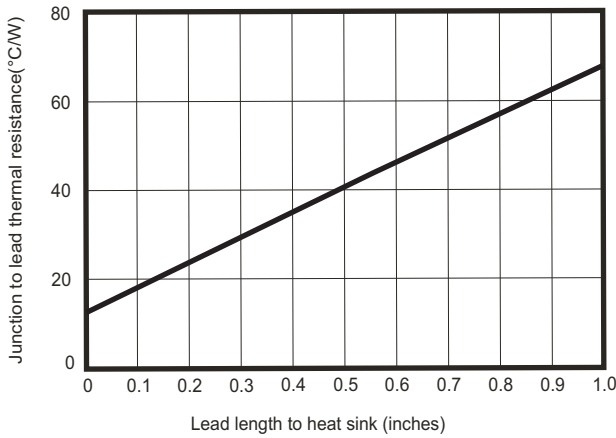

Fig.4 Maximum surge power

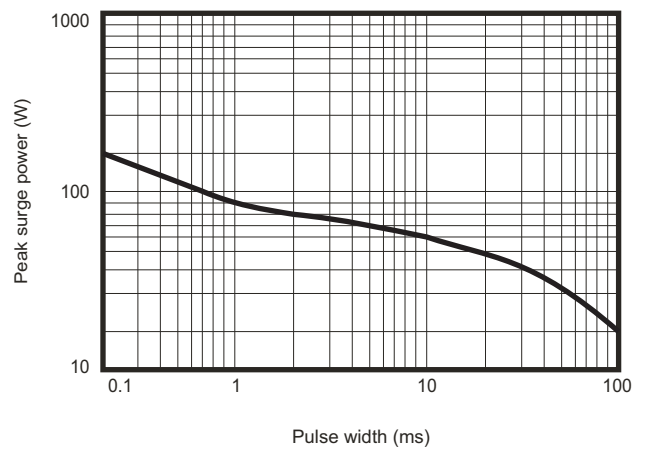
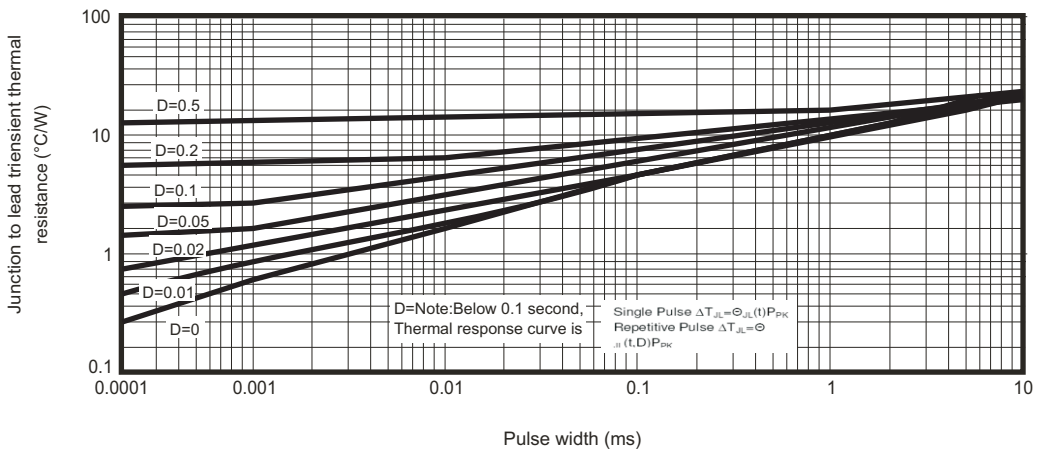
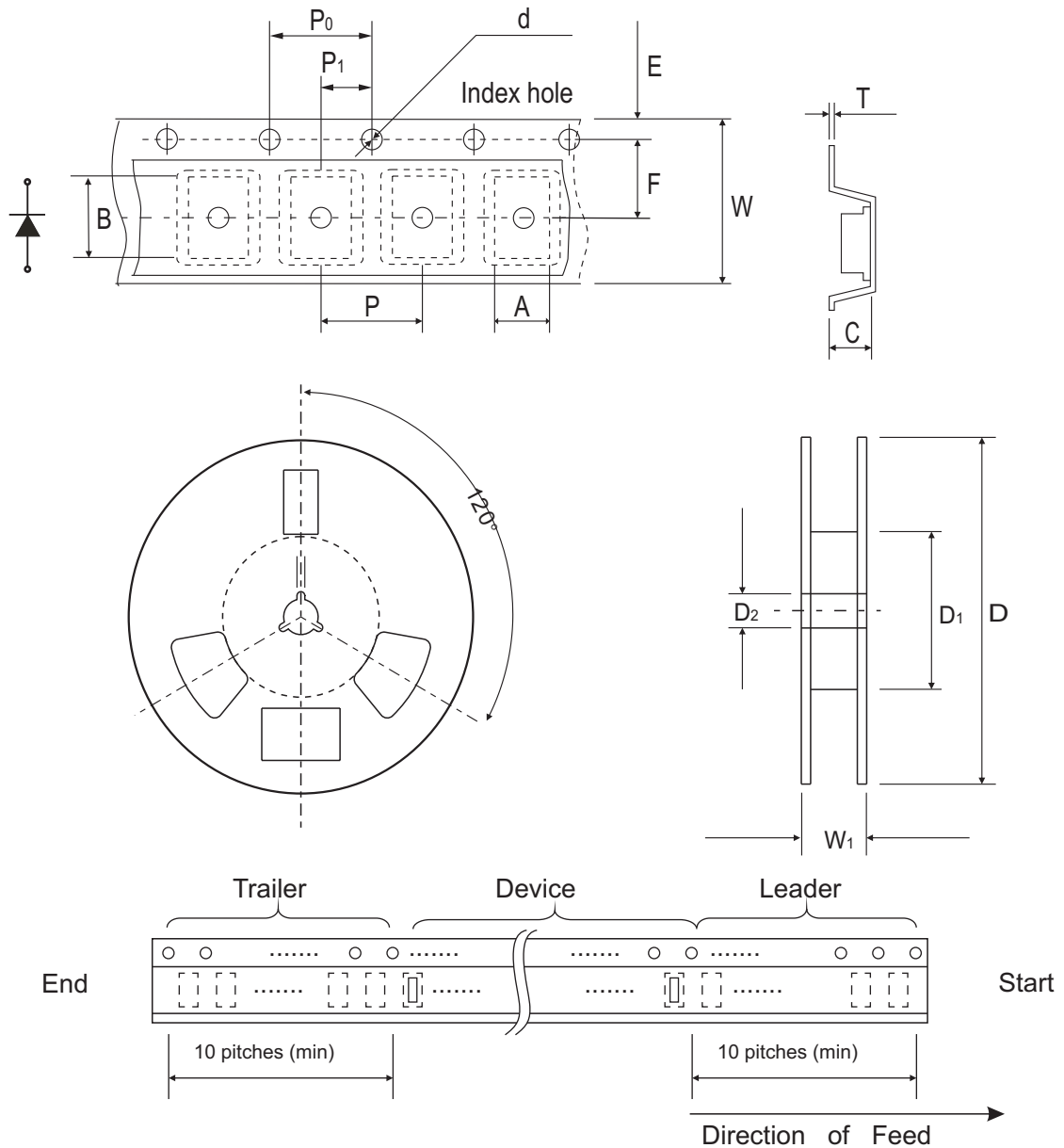

Fig.5 Typical thermal response L, lead length=3/8 inch



Reel Taping Specification



DO-214AA (SMB)	SYMBOL	A	B	C	d	D	D1	D2
	(mm)	3.67 ± 0.10	5.69 ± 0.10	2.67 ± 0.10	1.55 ± 0.10	330 ± 2.00	50.0 MIN.	13.0 ± 0.20
	(inch)	0.144 ± 0.004	0.224 ± 0.004	0.105 ± 0.004	0.061 ± 0.004	12.99 ± 0.079	1.969 MIN.	0.512 ± 0.008

DO-214AA (SMB)	SYMBOL	E	F	P	P0	P1	t	W	W1
	(mm)	1.75 ± 0.10	5.50 ± 0.05	8.00 ± 0.10	4.00 ± 0.10	2.00 ± 0.05	0.40(MAX)	12.0 ± 0.30	18.4 (max)
	(inch)	0.069 ± 0.004	0.217 ± 0.002	0.315 ± 0.004	0.157 ± 0.004	0.079 ± 0.002	0.016 (max)	0.472 ± 0.012	0.724 (max)

Marking Code

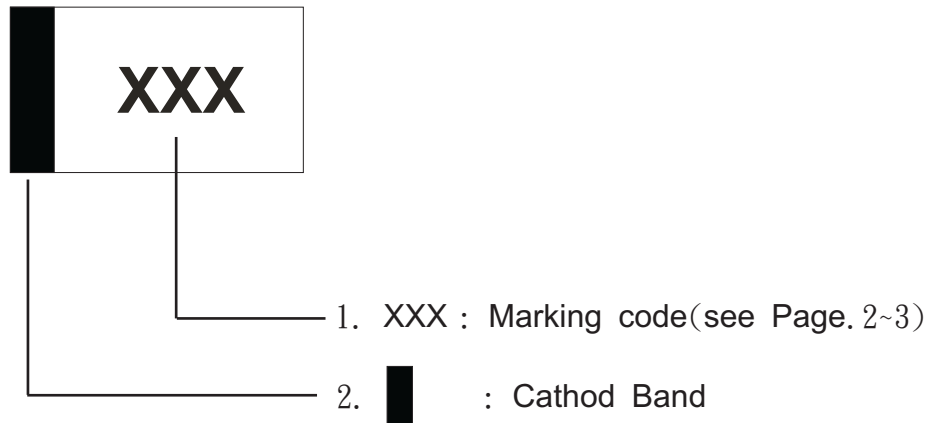

Suggested PAD Layout

SIZE	SMB	
	(mm)	(inch)
A	4.50	0.177
B	1.50	0.059
C	3.60	0.142
D	6.00	0.236
E	3.00	0.118

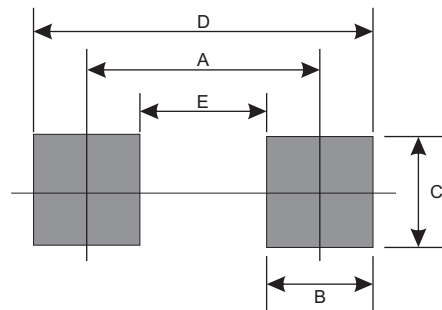

Standard Packaging

Case Type	Qty Per Reel	Reel Size
	(Pcs)	(inch)
SMB	3,000	13

Mouser Electronics

Authorized Distributor

Click to View Pricing, Inventory, Delivery & Lifecycle Information:

Comchip Technology:

[CZRB3005-G](#) [CZRB3006-G](#) [CZRB3007-G](#) [CZRB3008-G](#) [CZRB3009-G](#) [CZRB3010-G](#) [CZRB3011-G](#) [CZRB3013-G](#)
[CZRB3014-G](#) [CZRB3015-G](#) [CZRB3016-G](#) [CZRB3017-G](#) [CZRB3019-G](#) [CZRB3020-G](#) [CZRB3022-G](#) [CZRB3024-G](#)
[CZRB3027-G](#) [CZRB3028-G](#) [CZRB3056-G](#) [CZRB3062-G](#) [CZRB3068-G](#) [CZRB3075-G](#) [CZRB3082-G](#) [CZRB3091-G](#)
[CZRB3110-G](#) [CZRB3120-G](#) [CZRB3130-G](#) [CZRB3140-G](#) [CZRB3150-G](#) [CZRB3160-G](#) [CZRB3170-G](#) [CZRB3180-G](#)
[CZRB3190-G](#) [CZRB3200-G](#) [CZRB3043-G](#) [CZRB3047-G](#) [CZRB3036-G](#) [CZRB3039-G](#) [CZRB3051-G](#) [CZRB3033-G](#)
[CZRB3030-G](#)