

ISL60002

Precision Low Power FGA Voltage References

FN8082
Rev 23.00
Jan 14, 2019

The [ISL60002](#) FGA voltage references are very high precision analog voltage references fabricated using the Renesas proprietary Floating Gate Analog (FGA) technology and feature low supply voltage operation at ultra-low 350nA operating current.

Additionally, the ISL60002 family features ensured initial accuracy as low as $\pm 1.0\text{mV}$ and $20\text{ppm}/^\circ\text{C}$ temperature coefficient. The initial accuracy and temperature stability performance of the ISL60002 family, plus the low supply voltage and 350nA power consumption, eliminates the need to compromise thermal stability for reduced power consumption, making it an ideal companion to high resolution, low power data conversion systems.

Special Note: Post-assembly x-ray inspection can lead to permanent changes in device output voltage and should be minimized or avoided. For further information, please see [“Applications Information” on page 34](#) and [AN1533](#), “X-Ray Effects on FGA References”.

Applications

- High resolution A/Ds and D/As
- Digital meters
- Bar code scanners
- Mobile communications
- PDAs and notebooks
- Medical systems

Features

- Reference voltages 1.024V, 1.2V, 1.25V, 1.8V, 2.048V, 2.5V, 2.6V, 3.0V, and 3.3V
- Absolute initial accuracy options $\pm 1.0\text{mV}$, $\pm 2.5\text{mV}$, and $\pm 5.0\text{mV}$
- Supply voltage range
 - ISL60002-10, -11, -12, -18, -20, -25 2.7V to 5.5V
 - ISL60002-26 2.8V to 5.5V
 - ISL60002-30 3.2V to 5.5V
 - ISL60002-33 3.5V to 5.5V
- Ultra-low supply current. 350nA typ
- Low 20ppm/ $^\circ\text{C}$ temperature coefficient
- I_{SOURCE} and $I_{\text{SINK}} = 7\text{mA}$
- I_{SOURCE} and $I_{\text{SINK}} = 20\text{mA}$ for ISL60002-33 only
- ESD protection 5.5kV (Human Body Model)
- Standard 3 Ld SOT-23 packaging
- Operating temperature range
 - ISL60002-10, -11, -12, -18, -20, -25, -26, -30 -40°C to $+85^\circ\text{C}$
 - ISL60002-33 -40°C to $+105^\circ\text{C}$
- Pb-free (RoHS compliant)

Related Literature

For a full list of related documents, visit our website:

- [ISL60002](#) device page

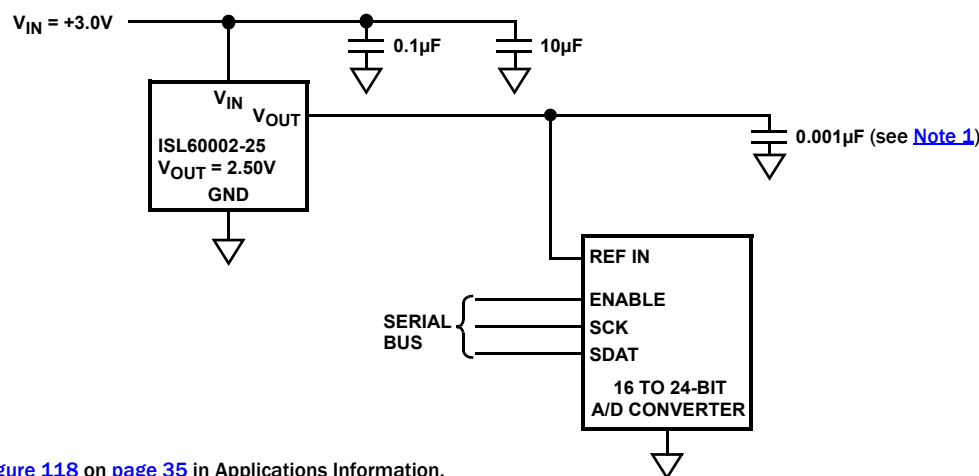

NOTE:
1. Also see [Figure 118](#) on [page 35](#) in Applications Information.

FIGURE 1. TYPICAL APPLICATION

Table of Contents

Pin Configuration	3
Pin Descriptions	3
Ordering Information	3
Absolute Maximum Ratings	5
Thermal Information	5
Environmental Operating Conditions	5
Recommended Operating Conditions	5
Electrical Specifications ISL60002-10, $V_{OUT} = 1.024V$	5
Electrical Specifications ISL60002-11, $V_{OUT} = 1.200V$	5
Electrical Specifications ISL60002-12, $V_{OUT} = 1.250V$	6
Electrical Specifications ISL60002-18, $V_{OUT} = 1.800V$	6
Electrical Specifications ISL60002-20, $V_{OUT} = 2.048V$	6
Electrical Specifications ISL60002-25, $V_{OUT} = 2.500V$	7
Electrical Specifications ISL60002-26, $V_{OUT} = 2.600V$	7
Electrical Specifications ISL60002-30, $V_{OUT} = 3.000V$	8
Electrical Specifications ISL60002-33, $V_{OUT} = 3.300V$	8
Common Electrical Specifications ISL60002 -10, -11, -12, -18, -20, and -25	9
Typical Performance Characteristic Curves, $V_{OUT} = 1.024V$	10
Typical Performance Characteristic Curves, $V_{OUT} = 1.20V$	13
Typical Performance Characteristic Curves, $V_{OUT} = 1.25V$	16
Typical Performance Curves, $V_{OUT} = 1.8V$	19
Typical Performance Curves, $V_{OUT} = 2.048V$	22
Typical Performance Characteristic Curves, $V_{OUT} = 2.50V$	25
Typical Performance Characteristic Curves, $V_{OUT} = 3.0V$	28
Typical Performance Characteristic Curves, $V_{OUT} = 3.3V$	31
High Current Application	34
Applications Information	34
FGA Technology	34
Nanopower Operation	34
Board Mounting Considerations	34
Board Assembly Considerations	35
Special Applications Considerations	35
Noise Performance and Reduction	35
Turn-On Time	36
Temperature Coefficient	36
Typical Application Circuits	37
Revision History	38
Package Outline Drawing	39

Pin Configuration

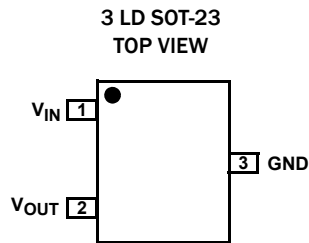

Pin Descriptions

PIN #	PIN NAME	DESCRIPTION
1	V _{IN}	Power Supply Input
2	V _{OUT}	Voltage Reference Output
3	GND	Ground

Ordering Information

PART NUMBER (Notes 3, 4)	PART MARKING (Note 5)	V _{OUT} (V)	GRADE	TEMP. RANGE (°C)	TAPE AND REEL (UNITS) (Note 2)	PACKAGE (RoHS COMPLIANT)	PKG. DWG. #
ISL60002BIH310Z-T7A	DFB	1.024	±1.0mV, 20ppm/°C	-40 to +85	250	3 Ld SOT-23	P3.064A
ISL60002BIH310Z-TK	DFB	1.024	±1.0mV, 20ppm/°C	-40 to +85	1k	3 Ld SOT-23	P3.064A
ISL60002CIH310Z-TK	DFC	1.024	±2.5mV, 20ppm/°C	-40 to +85	1k	3 Ld SOT-23	P3.064A
ISL60002DIH310Z-T7A	DFD	1.024	±5.0mV, 20ppm/°C	-40 to +85	250	3 Ld SOT-23	P3.064A
ISL60002DIH310Z-TK	DFD	1.024	±5.0mV, 20ppm/°C	-40 to +85	1k	3 Ld SOT-23	P3.064A
ISL60002BIH311Z-TK	APM	1.200	±1.0mV, 20ppm/°C	-40 to +85	1k	3 Ld SOT-23	P3.064A
ISL60002CIH311Z-TK	AOR	1.200	±2.5mV, 20ppm/°C	-40 to +85	1k	3 Ld SOT-23	P3.064A
ISL60002DIH311Z-TK	AOY	1.200	±5.0mV, 20ppm/°C	-40 to +85	1k	3 Ld SOT-23	P3.064A
ISL60002BIH312Z-TK	AOM	1.250	±1.0mV, 20ppm/°C	-40 to +85	1k	3 Ld SOT-23	P3.064A
ISL60002CIH312Z-TK	AOS	1.250	±2.5mV, 20ppm/°C	-40 to +85	1k	3 Ld SOT-23	P3.064A
ISL60002DIH312Z-T7A	APA	1.250	±5.0mV, 20ppm/°C	-40 to +85	250	3 Ld SOT-23	P3.064A
ISL60002DIH312Z-TK	APA	1.250	±5.0mV, 20ppm/°C	-40 to +85	1k	3 Ld SOT-23	P3.064A
ISL60002BIH318Z-TK	DEO	1.800	±1.0mV, 20ppm/°C	-40 to +85	1k	3 Ld SOT-23	P3.064A
ISL60002CIH318Z-TK	DEP	1.800	±2.5mV, 20ppm/°C	-40 to +85	1k	3 Ld SOT-23	P3.064A
ISL60002DIH318Z-TK	DEQ	1.800	±5.0mV, 20ppm/°C	-40 to +85	1k	3 Ld SOT-23	P3.064A
ISL60002BIH320Z-T7A	DEY	2.048	±1.0mV, 20ppm/°C	-40 to +85	250	3 Ld SOT-23	P3.064A
ISL60002BIH320Z-TK	DEY	2.048	±1.0mV, 20ppm/°C	-40 to +85	1k	3 Ld SOT-23	P3.064A
ISL60002CIH320Z-TK	DEZ	2.048	±2.5mV, 20ppm/°C	-40 to +85	1k	3 Ld SOT-23	P3.064A
ISL60002DIH320Z-TK	DFA	2.048	±5.0mV, 20ppm/°C	-40 to +85	1k	3 Ld SOT-23	P3.064A
ISL60002BIH325Z-T7A	AON	2.500	±1.0mV, 20ppm/°C	-40 to +85	250	3 Ld SOT-23	P3.064A
ISL60002BIH325Z-TK	AON	2.500	±1.0mV, 20ppm/°C	-40 to +85	1k	3 Ld SOT-23	P3.064A
ISL60002CIH325Z-T7A	AOT	2.500	±2.5mV, 20ppm/°C	-40 to +85	250	3 Ld SOT-23	P3.064A
ISL60002CIH325Z-TK	AOT	2.500	±2.5mV, 20ppm/°C	-40 to +85	1k	3 Ld SOT-23	P3.064A
ISL60002DIH325Z-T7A	APB	2.500	±5.0mV, 20ppm/°C	-40 to +85	250	3 Ld SOT-23	P3.064A
ISL60002DIH325Z-TK	APB	2.500	±5.0mV, 20ppm/°C	-40 to +85	1k	3 Ld SOT-23	P3.064A
ISL60002BIH326Z-TK	DFK	2.600	±1.0mV, 20ppm/°C	-40 to +85	1k	3 Ld SOT-23	P3.064A
ISL60002CIH326Z-TK	DFL	2.600	±2.5mV, 20ppm/°C	-40 to +85	1k	3 Ld SOT-23	P3.064A
ISL60002DIH326Z-TK	DFM	2.600	±5.0mV, 20ppm/°C	-40 to +85	1k	3 Ld SOT-23	P3.064A

Ordering Information (Continued)

PART NUMBER (Notes 3, 4)	PART MARKING (Note 5)	V _{OUT} (V)	GRADE	TEMP. RANGE (°C)	TAPE AND REEL (UNITS) (Note 2)	PACKAGE (RoHS COMPLIANT)	PKG. DWG. #
ISL60002BIH330Z-TK	DFI	3.000	±1.0mV, 20ppm/°C	-40 to +85	1k	3 Ld SOT-23	P3.064A
ISL60002CIH330Z-TK	DFJ	3.000	±2.5mV, 20ppm/°C	-40 to +85	1k	3 Ld SOT-23	P3.064A
ISL60002DIH330Z-T7A	DFH	3.000	±5.0mV, 20ppm/°C	-40 to +85	250	3 Ld SOT-23	P3.064A
ISL60002DIH330Z-TK	DFH	3.000	±5.0mV, 20ppm/°C	-40 to +85	1k	3 Ld SOT-23	P3.064A
ISL60002BAH333Z-T7A	AOP	3.300	±1.0mV, 20ppm/°C	-40 to +105	250	3 Ld SOT-23	P3.064A
ISL60002BAH333Z-TK	AOP	3.300	±1.0mV, 20ppm/°C	-40 to +105	1k	3 Ld SOT-23	P3.064A
ISL60002CAH333Z-TK	AOU	3.300	±2.5mV, 20ppm/°C	-40 to +105	1k	3 Ld SOT-23	P3.064A
ISL60002DAH333Z-T7A	APC	3.300	±5.0mV, 20ppm/°C	-40 to +105	250	3 Ld SOT-23	P3.064A
ISL60002DAH333Z-TK	APC	3.300	±5.0mV, 20ppm/°C	-40 to +105	1k	3 Ld SOT-23	P3.064A

NOTES:

- See [TB347](#) for details about reel specifications.
- These Pb-free plastic packaged products employ special Pb-free material sets, molding compounds/die attach materials, and 100% matte tin plate plus anneal (e3 termination finish, which is RoHS compliant and compatible with both SnPb and Pb-free soldering operations). Pb-free products are MSL classified at Pb-free peak reflow temperatures that meet or exceed the Pb-free requirements of IPC/JEDEC J STD-020.
- For Moisture Sensitivity Level (MSL), see the [ISL60002BIH310](#), [ISL60002BIH311](#), [ISL60002B12](#), [ISL60002BIH318](#), [ISL60002BIH320](#), [ISL60002BIH326](#), [ISL60002BIH330](#), [ISL60002B25](#), [ISL60002BAH333](#), [ISL60002CIH310](#), [ISL60002CIH311](#), [ISL60002C12](#), [ISL60002CIH318](#), [ISL60002CIH320](#), [ISL60002CIH326](#), [ISL60002CIH330](#), [ISL60002C25](#), [ISL60002CAH333](#), [ISL60002DIH310](#), [ISL60002DIH311](#), [ISL60002D12](#), [ISL60002DIH318](#), [ISL60002DIH320](#), [ISL60002DIH326](#), [ISL60002DIH330](#), [ISL60002D25](#), [ISL60002DAH333](#) device pages. For more information about MSL see [TB363](#).
- The part marking is located on the bottom of the part.

Absolute Maximum Ratings

Maximum Voltage V_{IN} to GND	-0.5V to +6.5V
Maximum Voltage V_{OUT} to GND (10s)	-0.5V to + $V_{OUT} + 1V$
Voltage on "DNC" Pins	No connections permitted to these pins
ESD Ratings	
Human Body Model	5.5kV
Machine Model	550V
Charged Device Model	2kV

Environmental Operating Conditions

X-Ray Exposure (Note 6)	10mRem
-------------------------	--------

Thermal Information

Thermal Resistance (Typical)	θ_{JA} (°C/W)	θ_{JC} (°C/W)
3 Ld SOT-23 (Notes 7, 8)	275	110
Continuous Power Dissipation ($T_A = +85^\circ\text{C}$)	99mW	
Maximum Junction Temperature (Plastic Package)	+107°C	
Storage Temperature Range	-65°C to +150°C	
Pb-Free Reflow Profile	see TB493	

Recommended Operating Conditions

Temperature Range	
Industrial	-40°C to +85°C
3.3V Version	-40°C to +105°C

CAUTION: Do not operate at or near the maximum ratings listed for extended periods of time. Exposure to such conditions can adversely impact product reliability and result in failures not covered by warranty.

NOTES:

- Measured with no filtering, distance of 10" from source, intensity set to 55kV and 70 μ A current, 30s duration. Other exposure levels should be analyzed for Output Voltage drift effects. See ["Applications Information" on page 34](#).
- θ_{JA} is measured with the component mounted on a high-effective thermal conductivity test board in free air. See [TB379](#) for details.
- For θ_{JC} , the "case temp" location is taken at the package top center.
- Post-reflow drift for the ISL60002 devices range from 100 μ V to 1.0mV based on experimental results with devices on FR4 double-sided boards. The design engineer must take this into account when considering the reference voltage after assembly.
- Post-assembly X-ray inspection can also lead to permanent changes in device output voltage and should be minimized or avoided. Initial accuracy can change 10mV or more under extreme radiation. Most inspection equipment does not affect the FGA reference voltage, but if X-ray inspection is required, it is advisable to monitor the reference output voltage to verify excessive shift has not occurred.

Electrical Specifications ISL60002-10, $V_{OUT} = 1.024V$ (Additional specifications on [page 9](#), "Common Electrical Specifications"). Operating conditions: $V_{IN} = 3.0V$, $I_{OUT} = 0mA$, $C_{OUT} = 0.001\mu F$, $T_A = -40$ to +85°C, unless otherwise specified. **Boldface limits apply across the operating temperature range, -40°C to +85°C.**

PARAMETER	SYMBOL	TEST CONDITIONS	MIN (Note 11)	TYP	MAX (Note 11)	UNIT
Output Voltage	V_{OUT}			1.024		V
V_{OUT} Accuracy (Notes 10, 12)	V_{OA}	$T_A = +25^\circ\text{C}$				
		ISL60002B10	-1.0		1.0	mV
		ISL60002C10	-2.5		2.5	mV
		ISL60002D10	-5.0		5.0	mV
Input Voltage Range	V_{IN}		2.7		5.5	V

Electrical Specifications ISL60002-11, $V_{OUT} = 1.200V$ (Additional specifications on [page 9](#), "Common Electrical Specifications"). Operating conditions: $V_{IN} = 3.0V$, $I_{OUT} = 0mA$, $C_{OUT} = 0.001\mu F$, $T_A = -40$ to +85°C, unless otherwise specified. **Boldface limits apply across the operating temperature range, -40°C to +85°C.**

PARAMETER	SYMBOL	TEST CONDITIONS	MIN (Note 11)	TYP	MAX (Note 11)	UNIT
Output Voltage	V_{OUT}			1.200		V
V_{OUT} Accuracy (Note 12)	V_{OA}	$T_A = +25^\circ\text{C}$				
		ISL60002B11	-1.0		1.0	mV
		ISL60002C11	-2.5		2.5	mV
		ISL60002D11	-5.0		5.0	mV
Input Voltage Range	V_{IN}		2.7		5.5	V

Electrical Specifications ISL60002-12, $V_{OUT} = 1.250V$ (Additional specifications on [page 9](#), “Common Electrical Specifications”). Operating conditions: $V_{IN} = 3.0V$, $I_{OUT} = 0mA$, $C_{OUT} = 0.001\mu F$, $T_A = -40$ to $+85^\circ C$, unless otherwise specified. **Boldface limits apply across the operating temperature range, $-40^\circ C$ to $+85^\circ C$.**

PARAMETER	SYMBOL	TEST CONDITIONS	MIN (Note 11)	TYP	MAX (Note 11)	UNIT
Output Voltage	V_{OUT}			1.250		V
V_{OUT} Accuracy (Note 12)	V_{OA}	$T_A = +25^\circ C$				
		ISL60002B12	-1.0		1.0	mV
		ISL60002C12	-2.5		2.5	mV
		ISL60002D12	-5.0		5.0	mV
Input Voltage Range	V_{IN}		2.7		5.5	V

Electrical Specifications ISL60002-18, $V_{OUT} = 1.800V$ (Additional specifications on [page 9](#), “Common Electrical Specifications”). Operating conditions: $V_{IN} = 3.0V$, $I_{OUT} = 0mA$, $C_{OUT} = 0.001\mu F$, $T_A = -40$ to $+85^\circ C$, unless otherwise specified. **Boldface limits apply across the operating temperature range, $-40^\circ C$ to $+85^\circ C$.**

PARAMETER	SYMBOL	TEST CONDITIONS	MIN (Note 11)	TYP	MAX (Note 11)	UNIT
Output Voltage	V_{OUT}			1.800		V
V_{OUT} Accuracy (Note 12)	V_{OA}	$T_A = +25^\circ C$				
		ISL60002B18	-1.0		1.0	mV
		ISL60002C18	-2.5		2.5	mV
		ISL60002D18	-5.0		5.0	mV
Input Voltage Range	V_{IN}		2.7		5.5	V

Electrical Specifications ISL60002-20, $V_{OUT} = 2.048V$ (Additional specifications on [page 9](#), “Common Electrical Specifications”). Operating Conditions: $V_{IN} = 3.0V$, $I_{OUT} = 0mA$, $C_{OUT} = 0.001\mu F$, $T_A = -40$ to $+85^\circ C$, unless otherwise specified. **Boldface limits apply across the operating temperature range, $-40^\circ C$ to $+85^\circ C$.**

PARAMETER	SYMBOL	TEST CONDITIONS	MIN (Note 11)	TYP	MAX (Note 11)	UNIT
Output Voltage	V_{OUT}			2.048		V
V_{OUT} Accuracy (Note 12)	V_{OA}	$T_A = +25^\circ C$				
		ISL60002B20	-1.0		1.0	mV
		ISL60002C20	-2.5		2.5	mV
		ISL60002D20	-5.0		5.0	mV
Input Voltage Range	V_{IN}		2.7		5.5	V

Electrical Specifications ISL60002-25, $V_{OUT} = 2.500V$ (Additional specifications on [page 9](#), “Common Electrical Specifications”). Operating conditions: $V_{IN} = 3.0V$, $I_{OUT} = 0mA$, $C_{OUT} = 0.001\mu F$, $T_A = -40$ to $+85^\circ C$, unless otherwise specified. **Boldface limits apply across the operating temperature range, $-40^\circ C$ to $+85^\circ C$.**

PARAMETER	SYMBOL	TEST CONDITIONS	MIN (Note 11)	TYP	MAX (Note 11)	UNIT
Output Voltage	V_{OUT}			2.500		V
V_{OUT} Accuracy (Note 12)	V_{OA}	$T_A = +25^\circ C$				
		ISL60002B25	-1.0		1.0	mV
		ISL60002C25	-2.5		2.5	mV
		ISL60002D25	-5.0		5.0	mV
Input Voltage Range	V_{IN}		2.7		5.5	V

Electrical Specifications ISL60002-26, $V_{OUT} = 2.600V$ (Additional specifications on [page 9](#), “Common Electrical Specifications”). Operating conditions: $V_{IN} = 3.0V$, $I_{OUT} = 0mA$, $C_{OUT} = 0.001\mu F$, $T_A = -40$ to $+85^\circ C$, unless otherwise specified. **Boldface limits apply across the operating temperature range, $-40^\circ C$ to $+85^\circ C$.**

PARAMETER	SYMBOL	TEST CONDITIONS	MIN (Note 11)	TYP	MAX (Note 11)	UNIT
Output Voltage	V_{OUT}			2.600		V
V_{OUT} Accuracy (Note 12)	V_{OA}	$T_A = +25^\circ C$				
		ISL60002B26	-1.0		1.0	mV
		ISL60002C26	-2.5		2.5	mV
		ISL60002D26	-5.0		5.0	mV
Input Voltage Range	V_{IN}		2.8		5.5	V
Output Voltage Temperature Coefficient (Note 12)	$TC V_{OUT}$				20	ppm/ $^\circ C$
Supply Current	I_{IN}			350	900	nA
Line Regulation	$\Delta V_{OUT}/\Delta V_{IN}$	$+2.8V \leq V_{IN} \leq +5.5V$		80	350	$\mu V/V$
Load Regulation	$\Delta V_{OUT}/\Delta I_{OUT}$	$0mA \leq I_{SOURCE} \leq 7mA$		25	100	$\mu V/mA$
		$-7mA \leq I_{SINK} \leq 0mA$		50	250	$\mu V/mA$
Thermal Hysteresis (Note 13)	$\Delta V_{OUT}/\Delta T_A$	$\Delta T_A = +125^\circ C$		100		ppm
Long Term Stability (Note 14)	$\Delta V_{OUT}/\Delta t$	$T_A = +25^\circ C$; first 1khrs		50		ppm
Short-Circuit Current (to GND)	I_{SC}	$T_A = +25^\circ C$		50		mA
Output Voltage Noise	V_N	$0.1Hz \leq f \leq 10Hz$		30		μV_{p-p}

Electrical Specifications ISL60002-30, $V_{OUT} = 3.000V$ Operating conditions: $V_{IN} = 5.0V$, $I_{OUT} = 0mA$, $C_{OUT} = 0.001\mu F$, $T_A = -40$ to $+85^\circ C$, unless otherwise specified. **Boldface limits apply across the operating temperature range, $-40^\circ C$ to $+85^\circ C$.**

PARAMETER	SYMBOL	TEST CONDITIONS	MIN (Note 11)	TYP	MAX (Note 11)	UNIT
Output Voltage	V_{OUT}			3.000		V
V_{OUT} Accuracy (Note 12)	V_{OA}	$T_A = +25^\circ C$				
		ISL60002B30	-1.0		1.0	mV
		ISL60002C30	-2.5		2.5	mV
		ISL60002D30	-5.0		5.0	mV
Input Voltage Range	V_{IN}		3.2		5.5	V
Output Voltage Temperature Coefficient (Note 12)	TC V_{OUT}				20	ppm/ $^\circ C$
Supply Current	I_{IN}			350	900	nA
Line Regulation	$\Delta V_{OUT}/\Delta V_{IN}$	$+3.2V \leq V_{IN} \leq +5.5V$		80	250	$\mu V/V$
Load Regulation	$\Delta V_{OUT}/\Delta I_{OUT}$	$0mA \leq I_{SOURCE} \leq 7mA$		25	100	$\mu V/mA$
		$-7mA \leq I_{SINK} \leq 0mA$		50	150	$\mu V/mA$
Thermal Hysteresis (Note 13)	$\Delta V_{OUT}/\Delta T_A$	$\Delta T_A = +125^\circ C$		100		ppm
Long Term Stability (Note 14)	$\Delta V_{OUT}/\Delta t$	$T_A = +25^\circ C$; first 1khrs		50		ppm
Short-Circuit Current (to GND)	I_{SC}	$T_A = +25^\circ C$		50		mA
Output Voltage Noise	V_N	$0.1Hz \leq f \leq 10Hz$		30		μV_{P-P}

Electrical Specifications ISL60002-33, $V_{OUT} = 3.300V$ Operating conditions: $V_{IN} = 5.0V$, $I_{OUT} = 0mA$, $C_{OUT} = 0.001\mu F$, $T_A = -40$ to $+105^\circ C$, unless otherwise specified. **Boldface limits apply across the operating temperature range, $-40^\circ C$ to $+105^\circ C$.**

PARAMETER	SYMBOL	TEST CONDITIONS	MIN (Note 11)	TYP	MAX (Note 11)	UNIT
Output Voltage	V_{OUT}			3.300		V
V_{OUT} Accuracy (Note 12)	V_{OA}	$T_A = +25^\circ C$				
		ISL60002B33	-1.0		1.0	mV
		ISL60002C33	-2.5		2.5	mV
		ISL60002D33	-5.0		5.0	mV
Output Voltage Temperature Coefficient (Note 12)	TC V_{OUT}				20	ppm/ $^\circ C$
Input Voltage Range	V_{IN}		3.5		5.5	V
Supply Current	I_{IN}			350	700	nA
Line Regulation	$\Delta V_{OUT}/\Delta V_{IN}$	$+3.5V \leq V_{IN} \leq +5.5V$		80	200	$\mu V/V$
Load Regulation	$\Delta V_{OUT}/\Delta I_{OUT}$	$0mA \leq I_{SOURCE} \leq 20mA$		25	100	$\mu V/mA$
		$-20mA \leq I_{SINK} \leq 0mA$		50	150	$\mu V/mA$
Thermal Hysteresis (Note 13)	$\Delta V_{OUT}/\Delta T_A$	$\Delta T_A = +145^\circ C$		100		ppm
Long Term Stability (Note 14)	$\Delta V_{OUT}/\Delta t$	$T_A = +25^\circ C$; first 1khrs		50		ppm
Short-Circuit Current (to GND)	I_{SC}	$T_A = +25^\circ C$		50		mA
Output Voltage Noise	V_N	$0.1Hz \leq f \leq 10Hz$		30		μV_{P-P}

Common Electrical Specifications ISL60002 -10, -11, -12, -18, -20, and -25 Operating conditions:

$V_{IN} = 3.0V$, $I_{OUT} = 0mA$, $C_{OUT} = 0.001\mu F$, $T_A = -40$ to $+85^\circ C$, unless otherwise specified. **Boldface limits apply across the operating temperature range, $-40^\circ C$ to $+85^\circ C$.**

PARAMETER	SYMBOL	TEST CONDITIONS	MIN (Note 11)	TYP	MAX (Note 11)	UNIT
Output Voltage Temperature Coefficient (Note 12)	TC V_{OUT}				20	ppm/ $^\circ C$
Supply Current	I_{IN}			350	900	nA
Line Regulation	$\Delta V_{OUT}/\Delta V_{IN}$	$+2.7V \leq V_{IN} \leq +5.5V$		80	250	$\mu V/V$
Load Regulation	$\Delta V_{OUT}/\Delta I_{OUT}$	$0mA \leq I_{SOURCE} \leq 7mA$		25	100	$\mu V/mA$
		$-7mA \leq I_{SINK} \leq 0mA$		50	150	$\mu V/mA$
Thermal Hysteresis (Note 13)	$\Delta V_{OUT}/\Delta T_A$	$\Delta T_A = +125^\circ C$		100		ppm
Long Term Stability (Note 14)	$\Delta V_{OUT}/\Delta t$	$T_A = +25^\circ C$; first 1khrs		50		ppm
Short-Circuit Current (to GND) (Note 15)	I_{SC}	$T_A = +25^\circ C$		50		mA
Output Voltage Noise	V_N	$0.1Hz \leq f \leq 10Hz$		30		μV_{P-P}

NOTES:

- Compliance to datasheet limits is assured by one or more methods: production test, characterization, and/or design.
- Across the specified temperature range. Temperature coefficient is measured by the box method where the change in V_{OUT} is divided by the temperature range: ($-40^\circ C$ to $+85^\circ C = +125^\circ C$, or $-40^\circ C$ to $+105^\circ C = +145^\circ C$ for the ISL60002-33).
- Thermal hysteresis is the change in V_{OUT} measured at $T_A = +25^\circ C$ after temperature cycling over a specified range, ΔT_A . V_{OUT} is read initially at $T_A = +25^\circ C$ for the device under test. The device is temperature cycled and a second V_{OUT} measurement is taken at $+25^\circ C$. The difference between the initial V_{OUT} reading and the second V_{OUT} reading is then expressed in ppm. For $\Delta T_A = +125^\circ C$, the device under test is cycled from $+25^\circ C$ to $+85^\circ C$ to $-40^\circ C$ to $+25^\circ C$, and for $\Delta T_A = +145^\circ C$, the device under test is cycled from $+25^\circ C$ to $+105^\circ C$ to $-40^\circ C$ to $+25^\circ C$.
- Long term drift is logarithmic in nature and diminishes over time. Drift after the first 1000 hours is approximately 10ppm.
- Short-circuit current (to V_{CC}) for ISL60002-25 at $V_{IN} = 5.0V$ and $+25^\circ C$ is typically around 30mA. Shorting V_{OUT} to V_{CC} is not recommended due to risk of resetting the part.

Typical Performance Characteristic Curves, $V_{OUT} = 1.024V$ $V_{IN} = 3.0V$,

$I_{OUT} = 0mA$, $T_A = +25^\circ C$ unless otherwise specified.

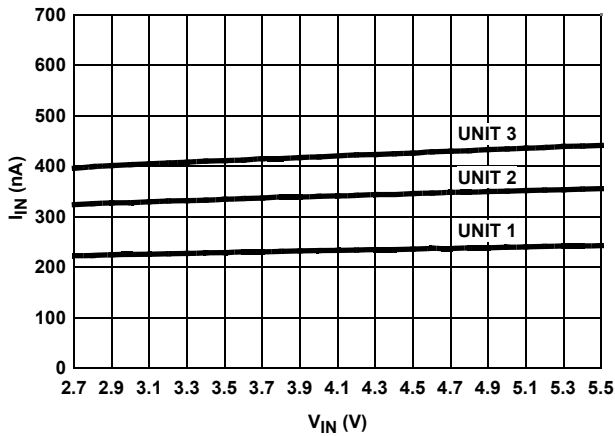

FIGURE 1. I_{IN} vs V_{IN} , 3 UNITS

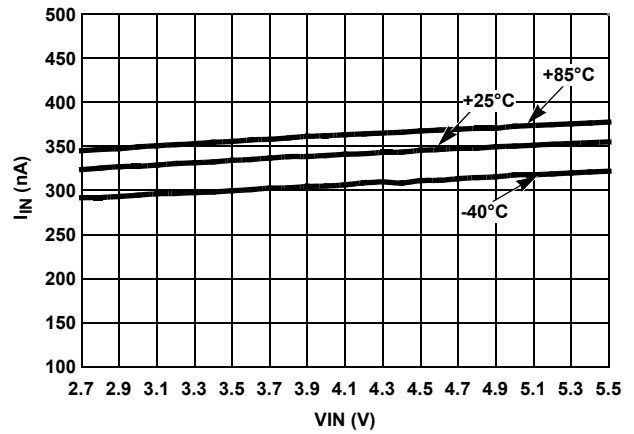

FIGURE 2. I_{IN} vs V_{IN} OVER-TEMPERATURE

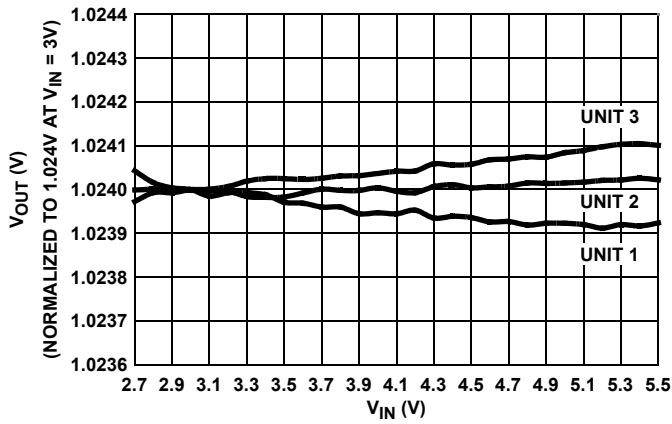

FIGURE 3. LINE REGULATION, 3 UNITS

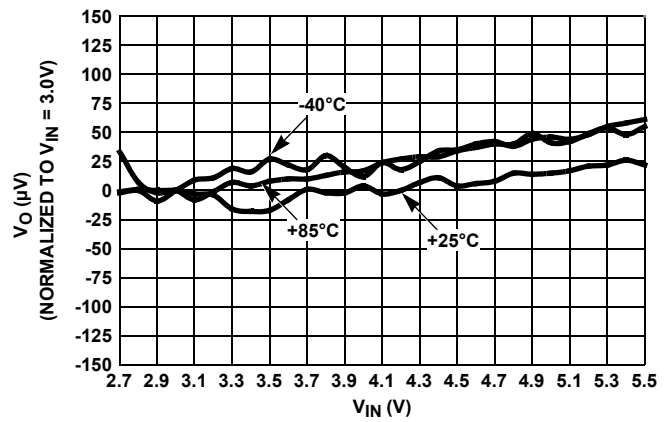

FIGURE 4. LINE REGULATION OVER-TEMPERATURE

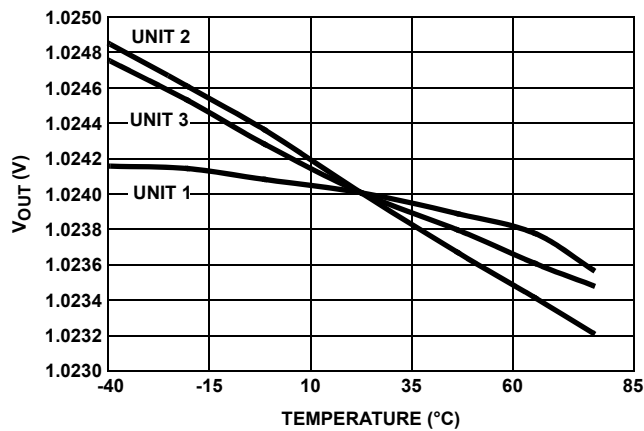

FIGURE 5. V_{OUT} vs TEMPERATURE NORMALIZED to $+25^\circ C$

Typical Performance Characteristic Curves, $V_{OUT} = 1.024V$ $V_{IN} = 3.0V,$
 $I_{OUT} = 0mA, T_A = +25^\circ C$ unless otherwise specified. (Continued)

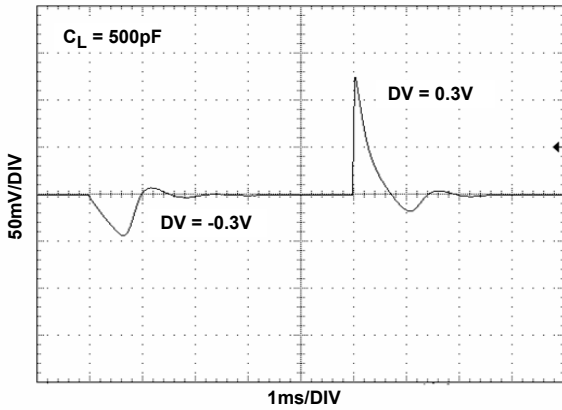

FIGURE 6. LINE TRANSIENT RESPONSE, WITH CAPACITIVE LOAD

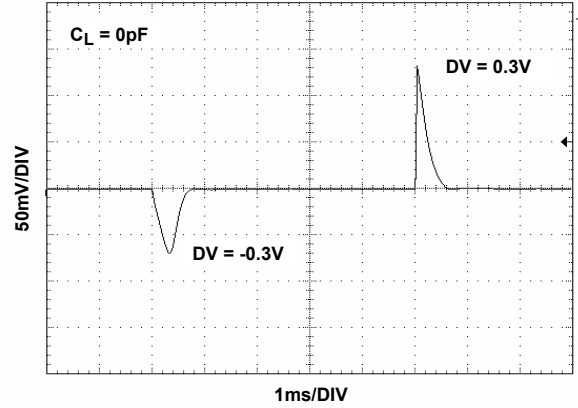

FIGURE 7. LINE TRANSIENT RESPONSE

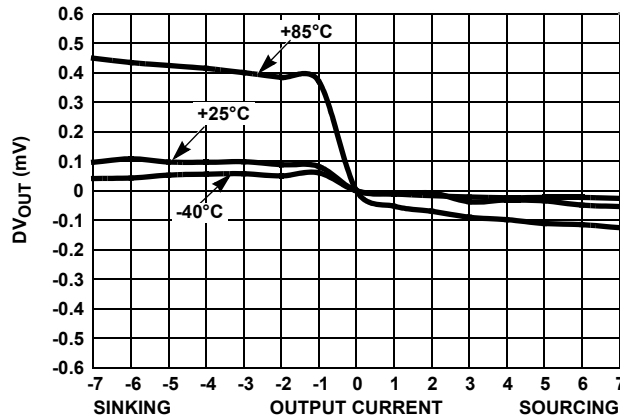

FIGURE 8. LOAD REGULATION OVER-TEMPERATURE

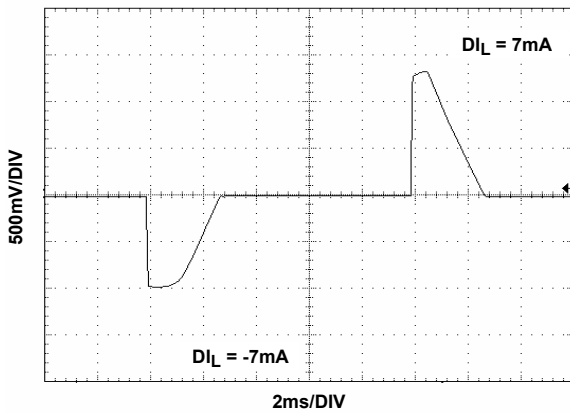

FIGURE 9. LOAD TRANSIENT RESPONSE

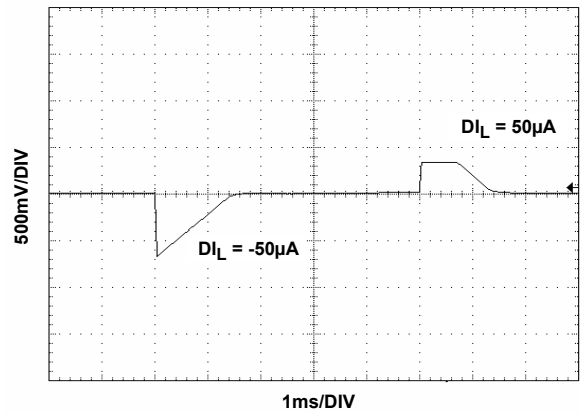

FIGURE 10. LOAD TRANSIENT RESPONSE

Typical Performance Characteristic Curves, $V_{OUT} = 1.024V$ $V_{IN} = 3.0V,$

$I_{OUT} = 0mA, T_A = +25^\circ C$ unless otherwise specified. (Continued)

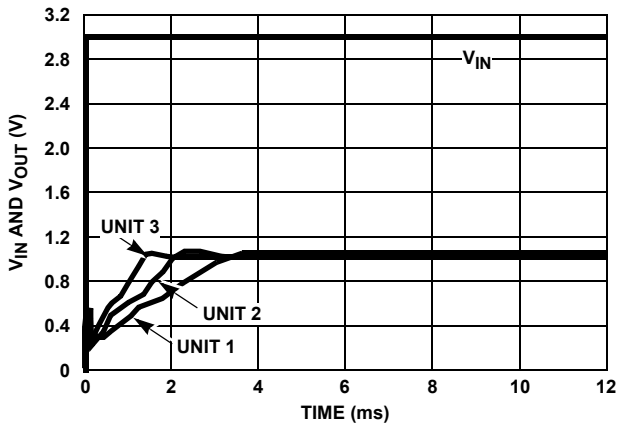

FIGURE 11. TURN-ON TIME (+25°C)

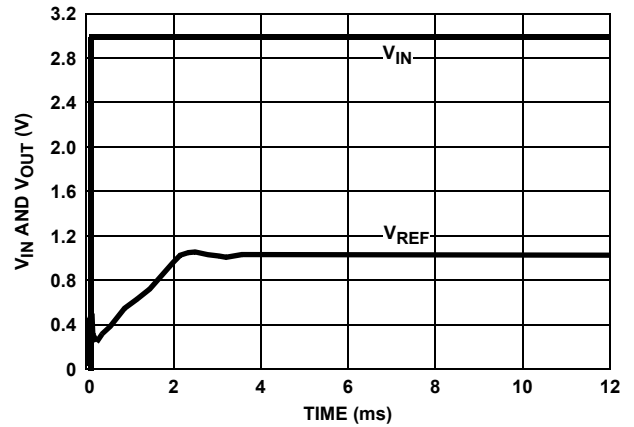

FIGURE 12. TURN-ON TIME (+25°C)

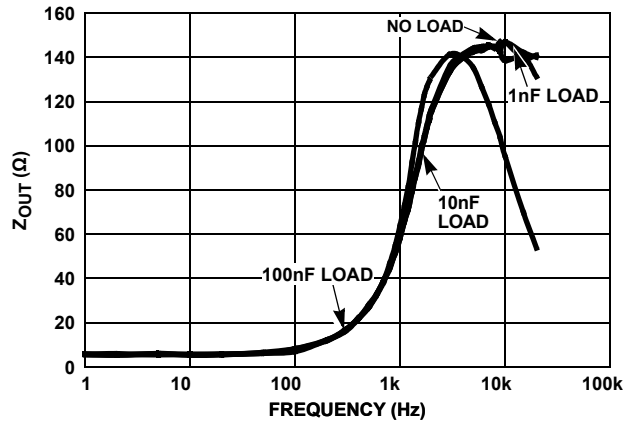

FIGURE 13. Z_{OUT} vs FREQUENCY

Typical Performance Characteristic Curves, $V_{OUT} = 1.20V$ $V_{IN} = 3.0V, I_{OUT} = 0mA,$
 $T_A = +25^\circ C$ unless otherwise specified.

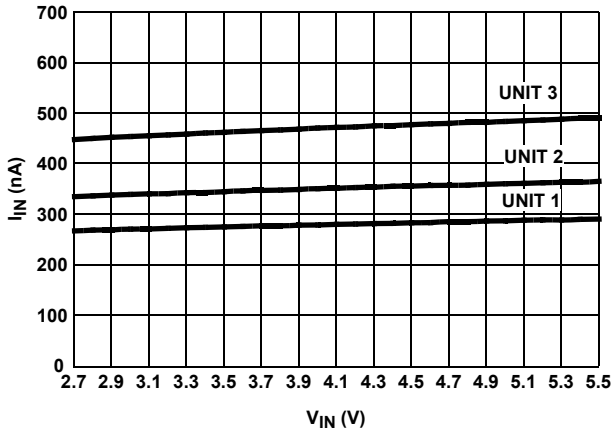

FIGURE 14. I_{IN} vs V_{IN} , 3 UNITS

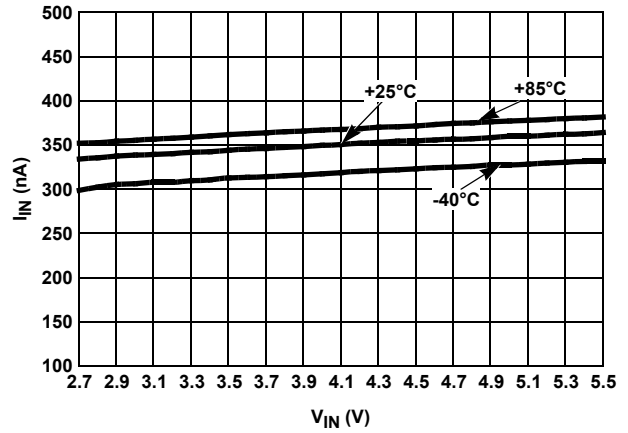

FIGURE 15. I_{IN} vs V_{IN} OVER-TEMPERATURE

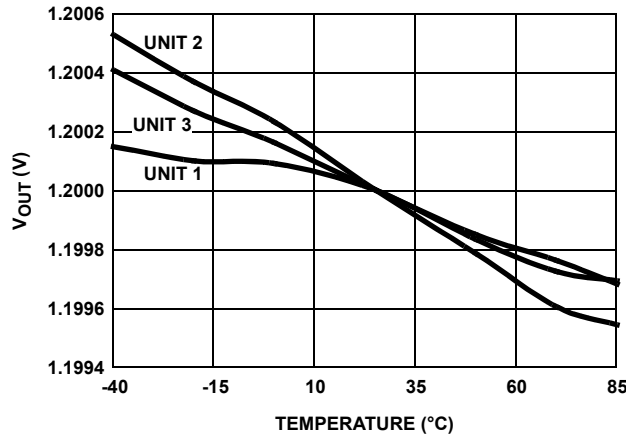

FIGURE 16. V_{OUT} vs TEMPERATURE NORMALIZED TO $+25^\circ C$

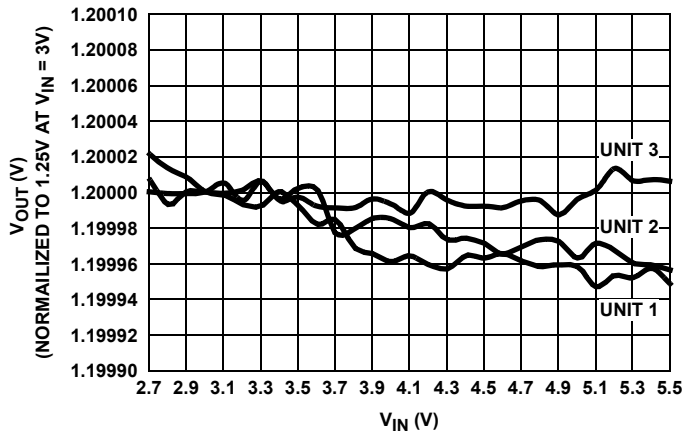

FIGURE 17. LINE REGULATION, 3 UNITS

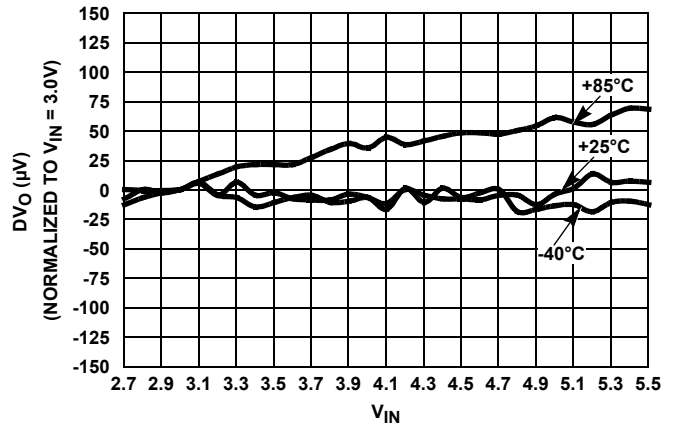

FIGURE 18. LINE REGULATION OVER-TEMPERATURE

Typical Performance Characteristic Curves, $V_{OUT} = 1.20V$ $V_{IN} = 3.0V, I_{OUT} = 0mA,$
 $T_A = +25^\circ C$ unless otherwise specified. (Continued)

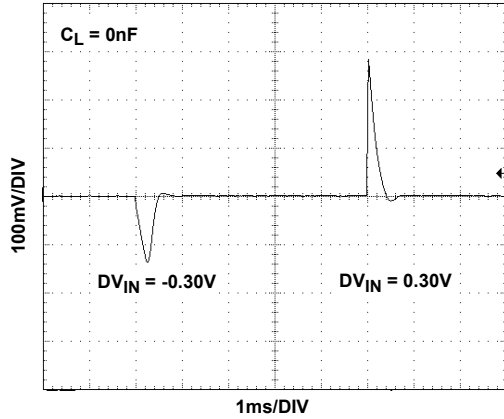

FIGURE 19. LINE TRANSIENT RESPONSE

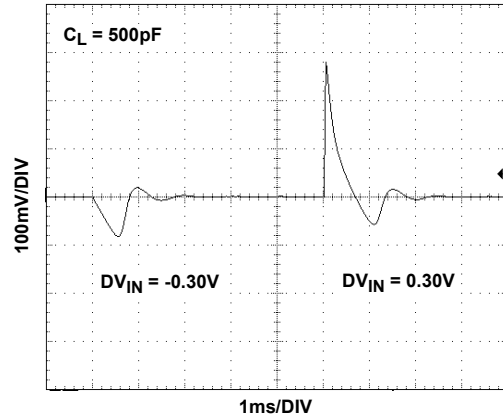

FIGURE 20. LINE TRANSIENT RESPONSE WITH CAPACITIVE LOAD

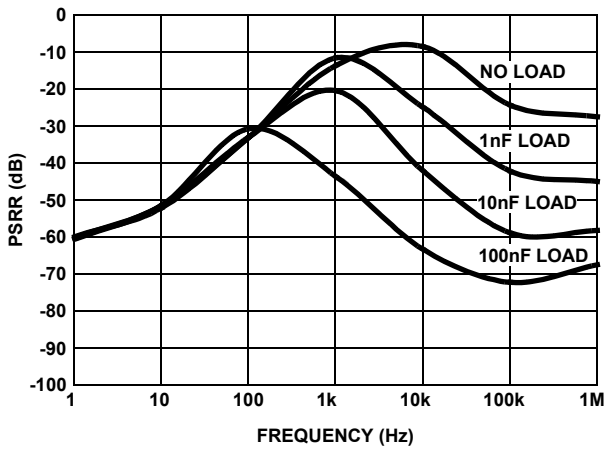

FIGURE 21. PSRR vs CAPACITIVE LOAD

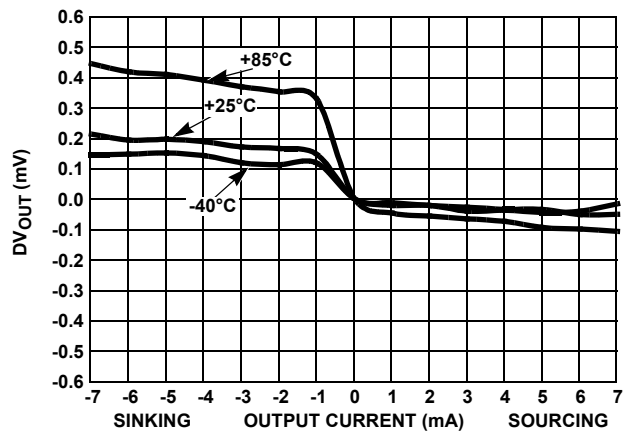

FIGURE 22. LOAD REGULATION OVER-TEMPERATURE

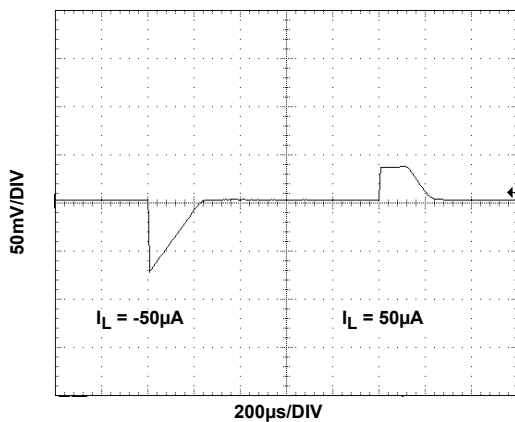

FIGURE 23. LOAD TRANSIENT RESPONSE

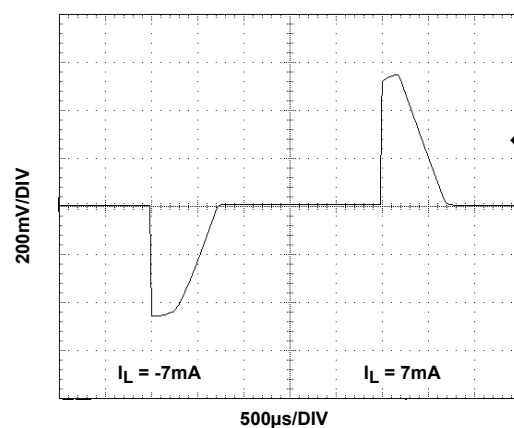

FIGURE 24. LOAD TRANSIENT RESPONSE

Typical Performance Characteristic Curves, $V_{OUT} = 1.20V$ $V_{IN} = 3.0V, I_{OUT} = 0mA,$
 $T_A = +25^\circ C$ unless otherwise specified. (Continued)

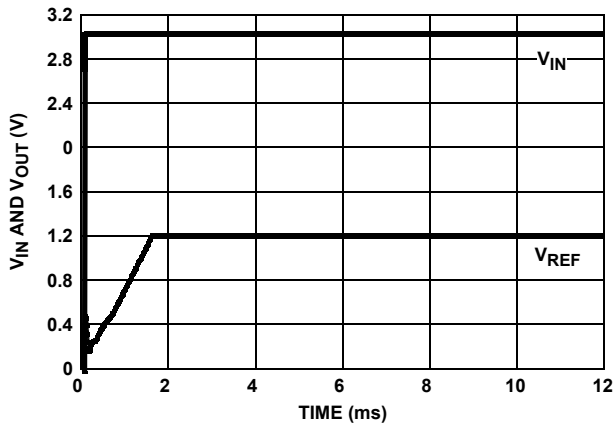

FIGURE 25. TURN-ON TIME (+25°C)

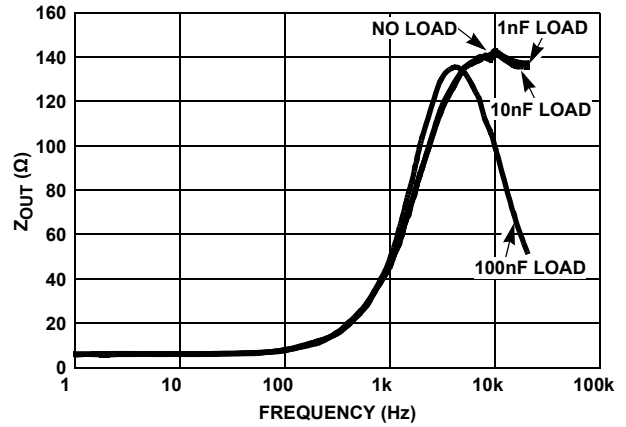

FIGURE 26. Z_{OUT} vs FREQUENCY

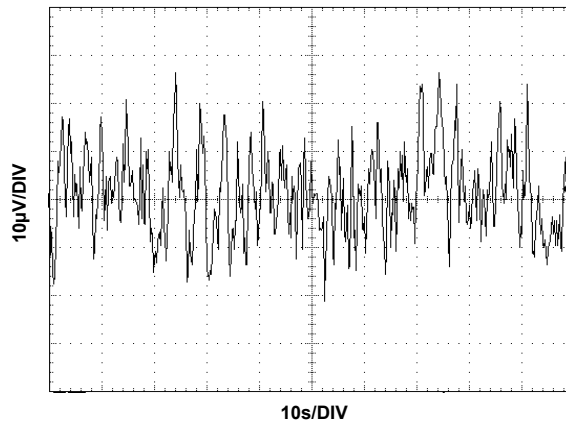

FIGURE 27. V_{OUT} NOISE

Typical Performance Characteristic Curves, $V_{OUT} = 1.25V$ $V_{IN} = 3.0V, I_{OUT} = 0mA,$
 $T_A = +25^\circ C$ unless otherwise specified.

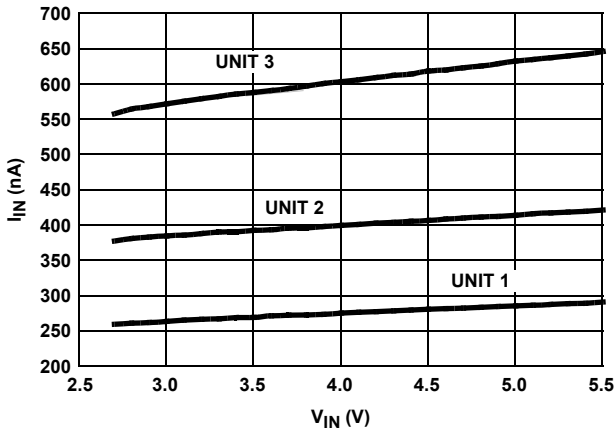

FIGURE 28. I_{IN} vs V_{IN} , 3 UNITS

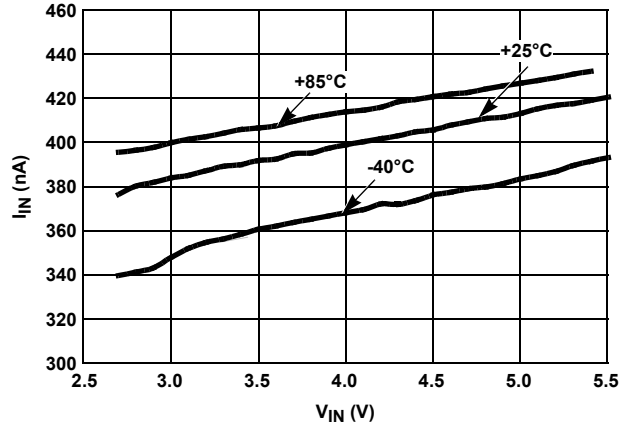

FIGURE 29. I_{IN} vs V_{IN} OVER-TEMPERATURE

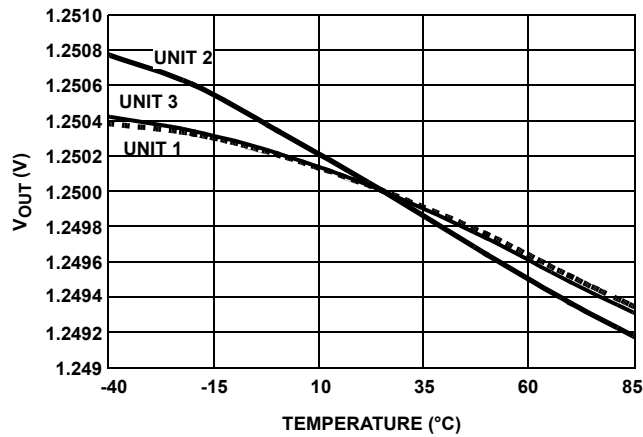

FIGURE 30. V_{OUT} vs TEMPERATURE NORMALIZED TO $+25^\circ C$

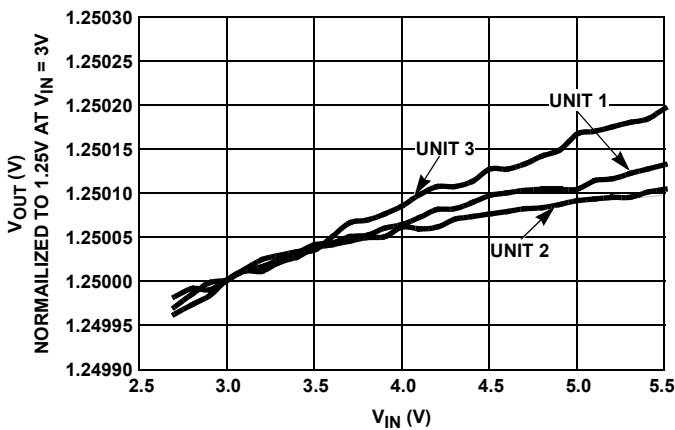

FIGURE 31. LINE REGULATION, 3 UNITS

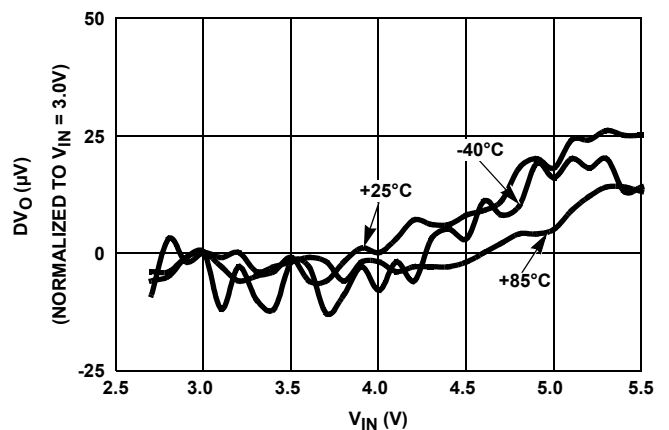

FIGURE 32. LINE REGULATION OVER-TEMPERATURE

Typical Performance Characteristic Curves, $V_{OUT} = 1.25V$ $V_{IN} = 3.0V, I_{OUT} = 0mA,$
 $T_A = +25^\circ C$ unless otherwise specified. (Continued)

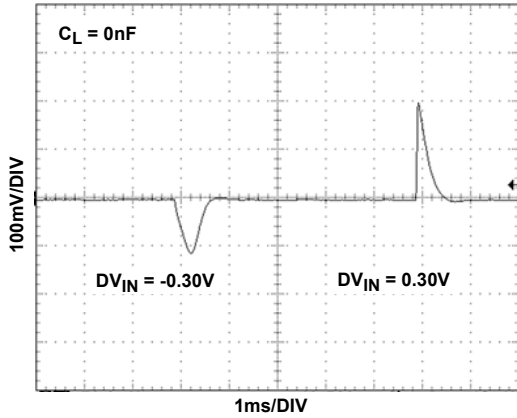

FIGURE 33. LINE TRANSIENT RESPONSE

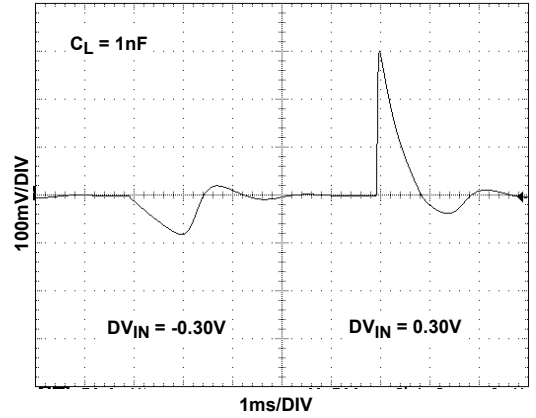

FIGURE 34. LINE TRANSIENT RESPONSE, WITH CAPACITIVE LOAD

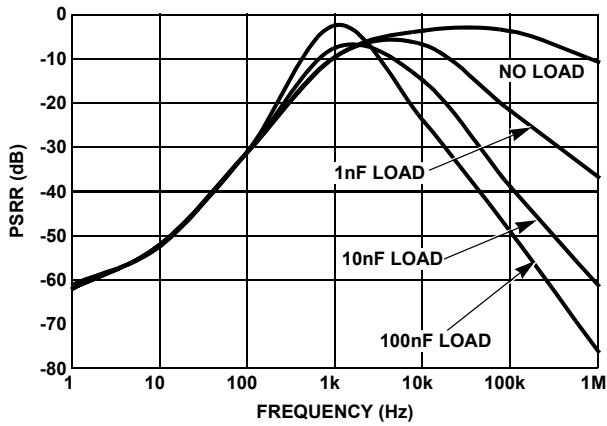

FIGURE 35. PSRR vs CAPACITIVE LOAD

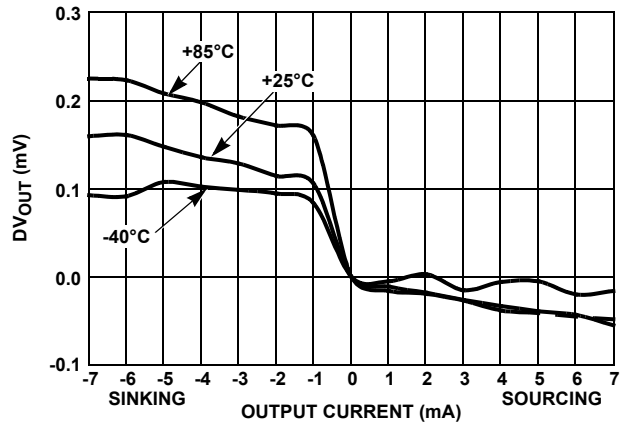

FIGURE 36. LOAD REGULATION

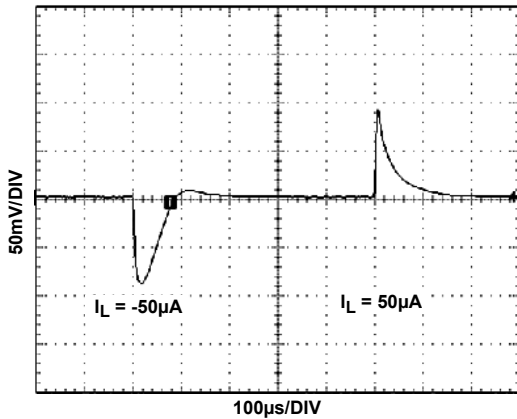

FIGURE 37. LOAD TRANSIENT RESPONSE

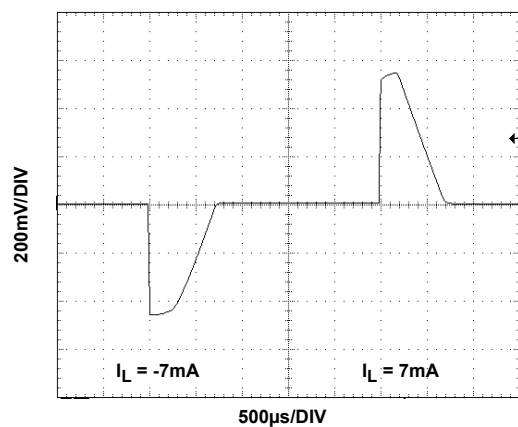

FIGURE 38. LOAD TRANSIENT RESPONSE

Typical Performance Characteristic Curves, $V_{OUT} = 1.25V$ $V_{IN} = 3.0V, I_{OUT} = 0mA,$
 $T_A = +25^\circ C$ unless otherwise specified. (Continued)

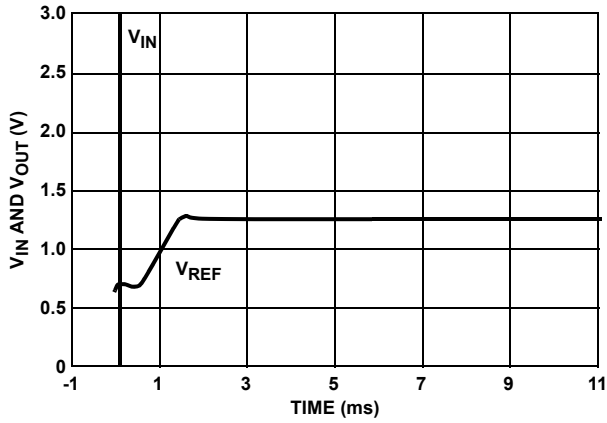

FIGURE 39. TURN-ON TIME (+25 °C)

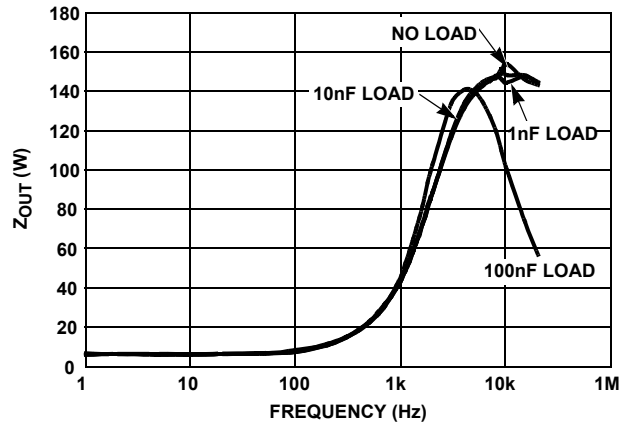

FIGURE 40. Z_{OUT} vs FREQUENCY

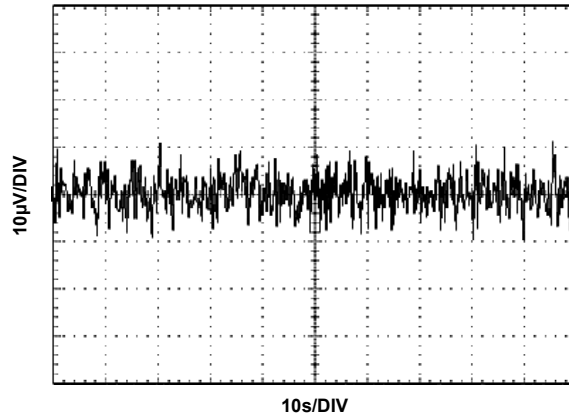

FIGURE 41. V_{OUT} NOISE

Typical Performance Curves, $V_{OUT} = 1.8V$

$V_{IN} = 3.0V, I_{OUT} = 0mA, T_A = +25^\circ C$ unless otherwise specified.

specified.

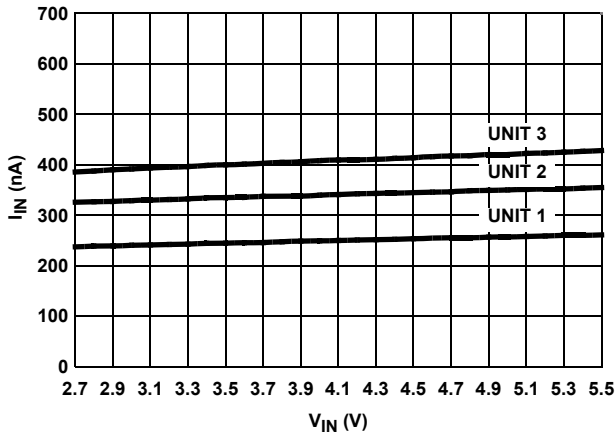

FIGURE 42. I_{IN} vs V_{IN} , 3 UNITS

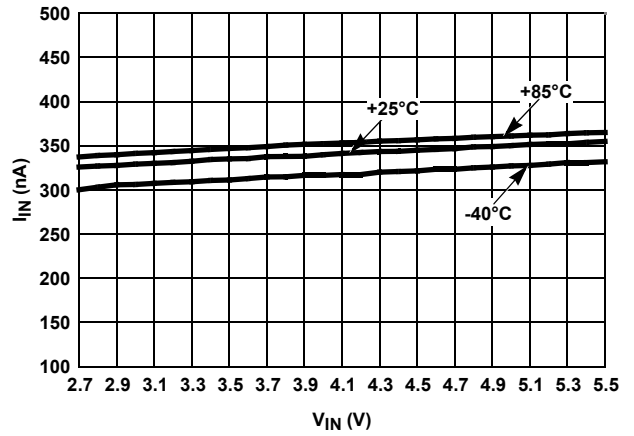

FIGURE 43. I_{IN} vs V_{IN} OVER-TEMPERATURE

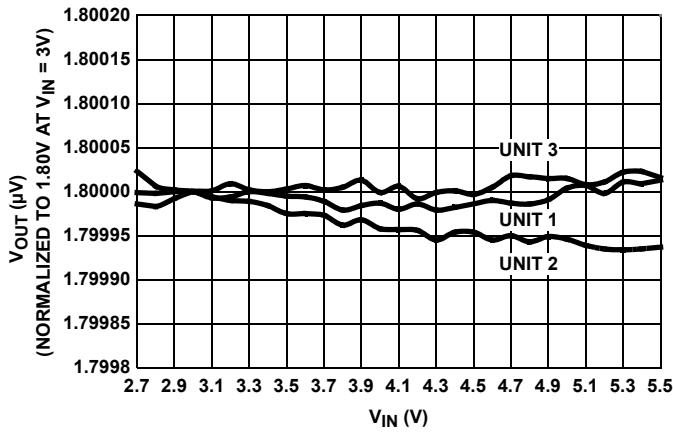

FIGURE 44. LINE REGULATION (3 REPRESENTATIVE UNITS)

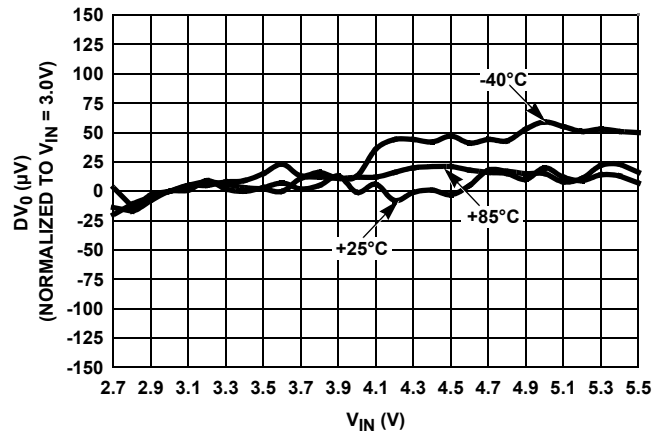

FIGURE 45. LINE REGULATION OVER-TEMPERATURE

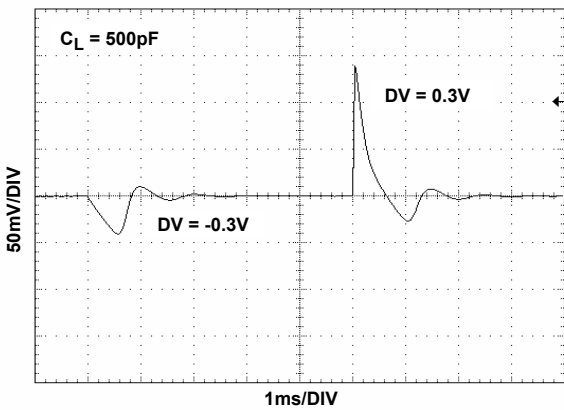

FIGURE 46. LINE TRANSIENT RESPONSE, WITH CAPACITIVE LOAD

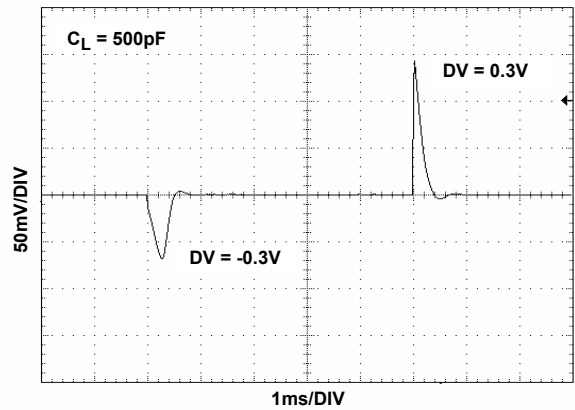

FIGURE 47. LINE TRANSIENT RESPONSE

Typical Performance Curves, $V_{OUT} = 1.8V$

specified. (Continued)

$V_{IN} = 3.0V, I_{OUT} = 0mA, T_A = +25^\circ C$ unless otherwise

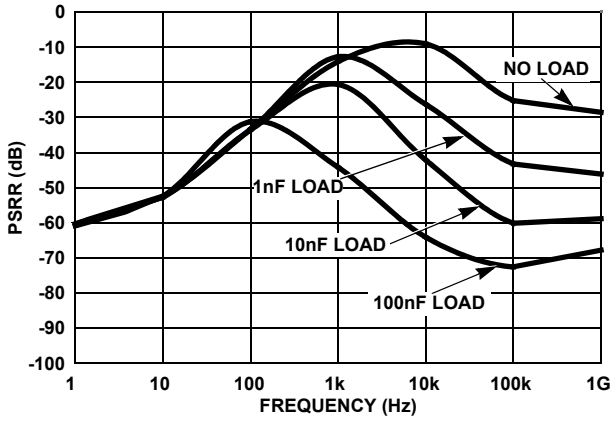

FIGURE 48. PSRR vs CAPACITIVE LOAD

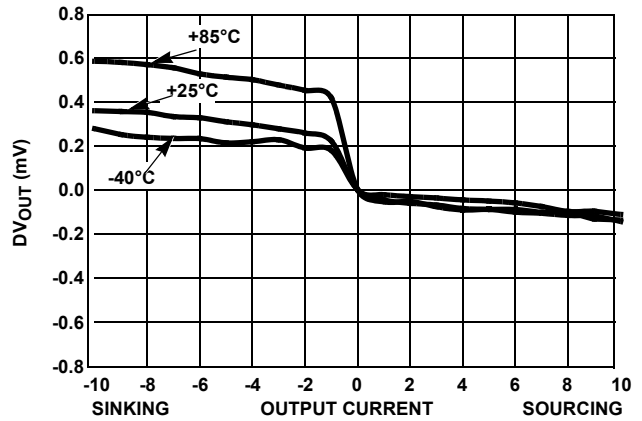

FIGURE 49. LOAD REGULATION OVER-TEMPERATURE

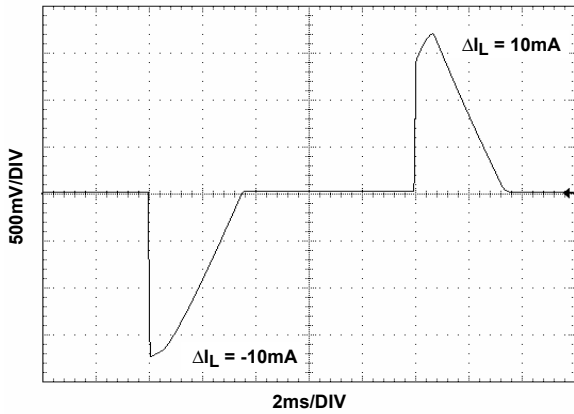

FIGURE 50. LOAD TRANSIENT RESPONSE

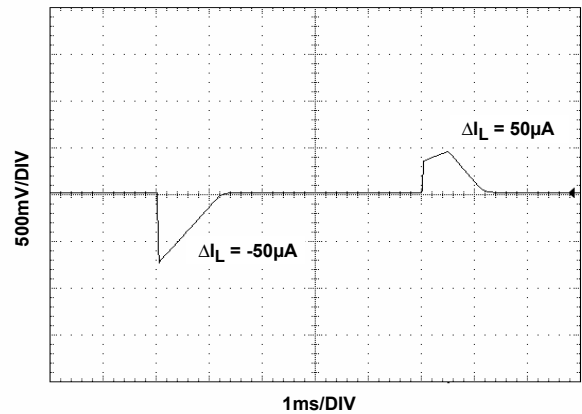

FIGURE 51. LOAD TRANSIENT RESPONSE

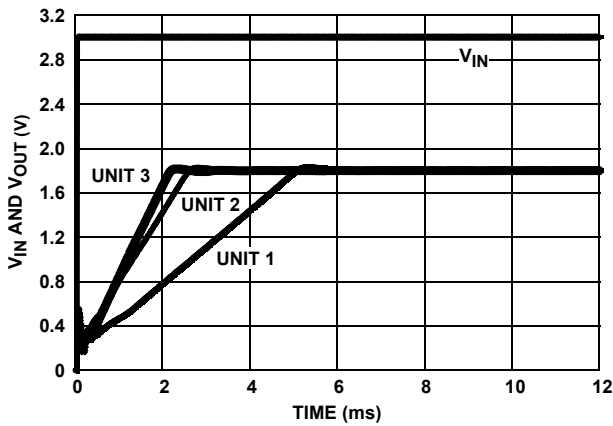

FIGURE 52. TURN-ON TIME (+25°C)

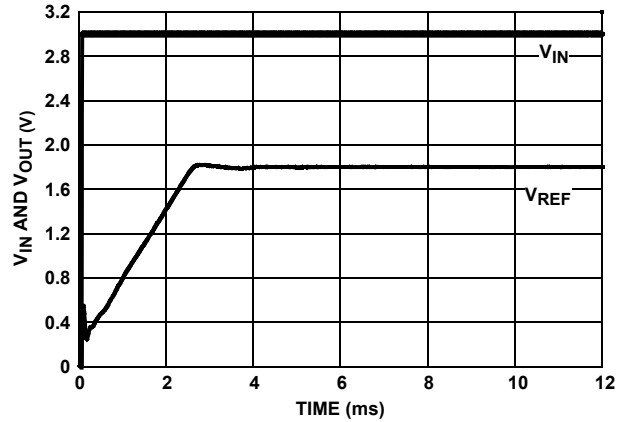

FIGURE 53. TURN-ON TIME (+25°C)

Typical Performance Curves, $V_{OUT} = 1.8V$

$V_{IN} = 3.0V, I_{OUT} = 0mA, T_A = +25^\circ C$ unless otherwise specified.

(Continued)

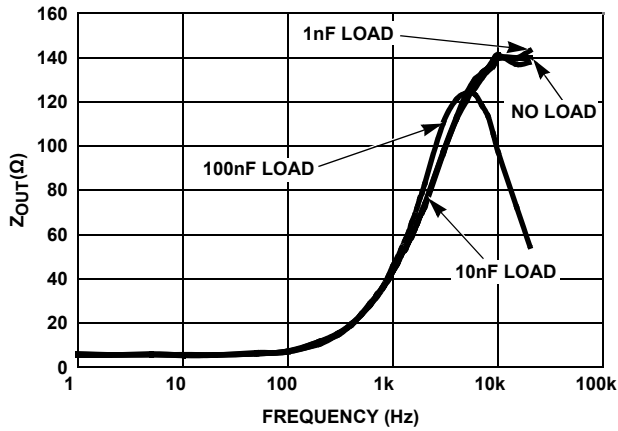

FIGURE 54. Z_{OUT} vs FREQUENCY

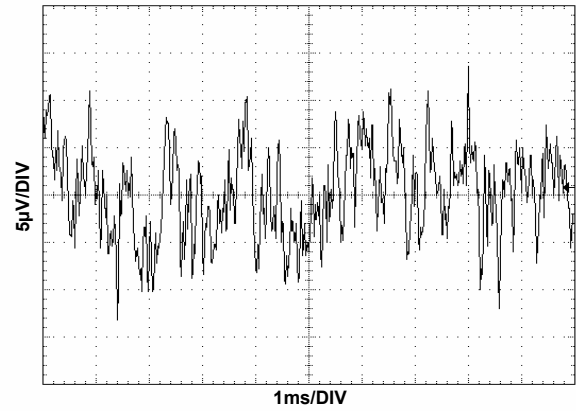

FIGURE 55. V_{OUT} NOISE

Typical Performance Curves, $V_{OUT} = 2.048V$ $V_{IN} = 3.0V, I_{OUT} = 0mA, T_A = +25^\circ C$ unless otherwise specified.

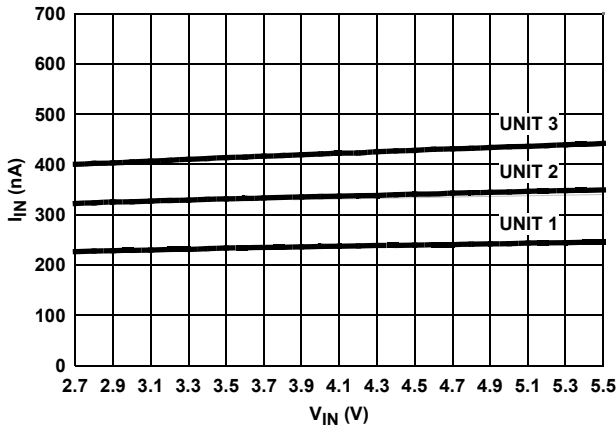

FIGURE 56. I_{IN} vs V_{IN} (3 REPRESENTATIVE UNITS)

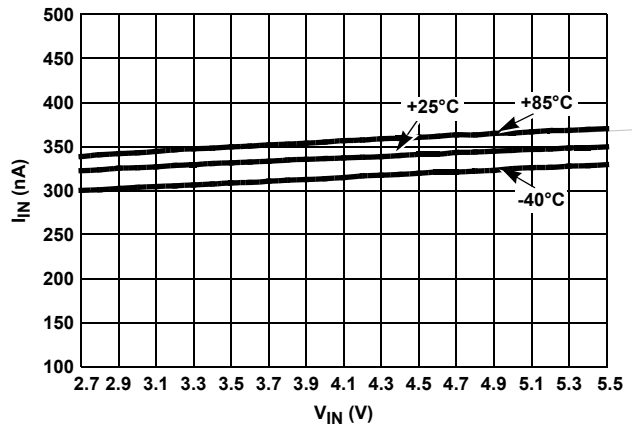

FIGURE 57. I_{IN} vs V_{IN} OVER-TEMPERATURE

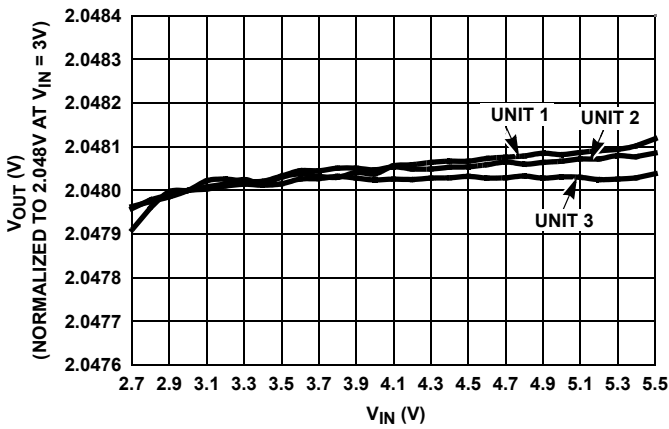

FIGURE 58. LINE REGULATION (3 REPRESENTATIVE UNITS)

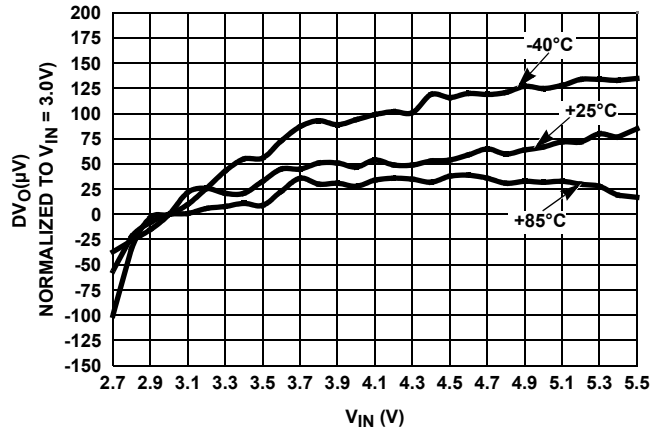

FIGURE 59. LINE REGULATION OVER-TEMPERATURE

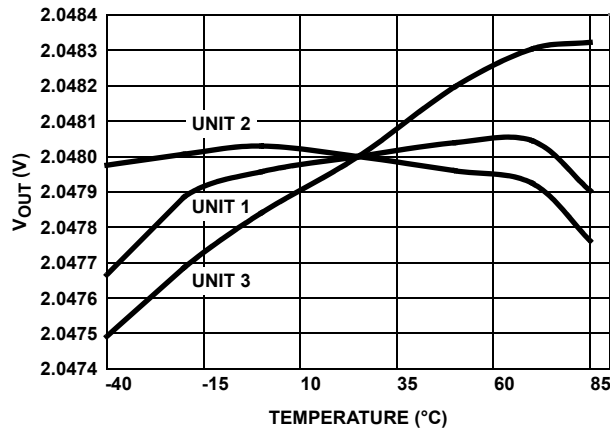

FIGURE 60. V_{OUT} vs TEMPERATURE NORMALIZED to $+25^\circ C$

Typical Performance Curves, $V_{OUT} = 2.048V$ $V_{IN} = 3.0V, I_{OUT} = 0mA, T_A = +25^\circ C$ unless otherwise specified. (Continued)

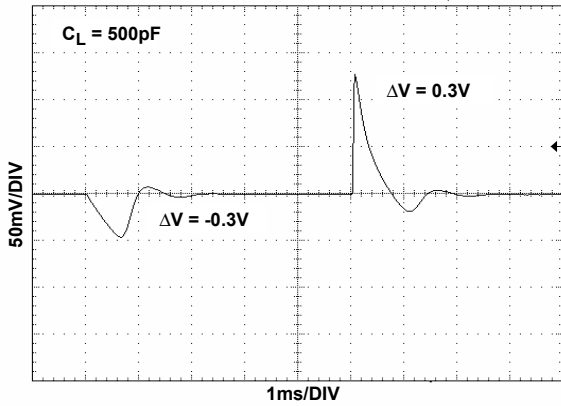

FIGURE 61. LINE TRANSIENT RESPONSE, WITH CAPACITIVE LOAD

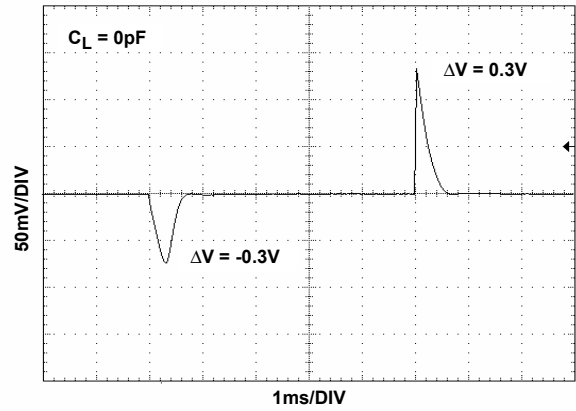

FIGURE 62. LINE TRANSIENT RESPONSE

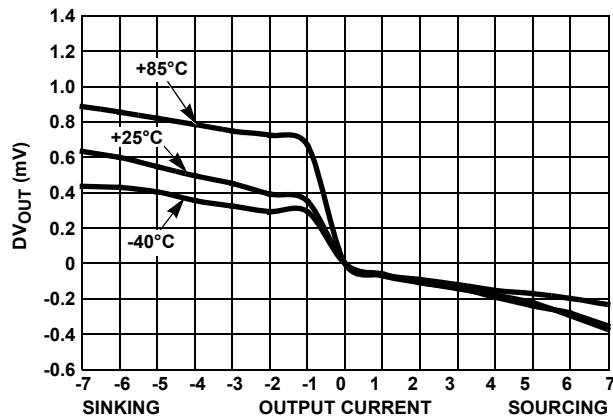

FIGURE 63. LOAD REGULATION OVER-TEMPERATURE

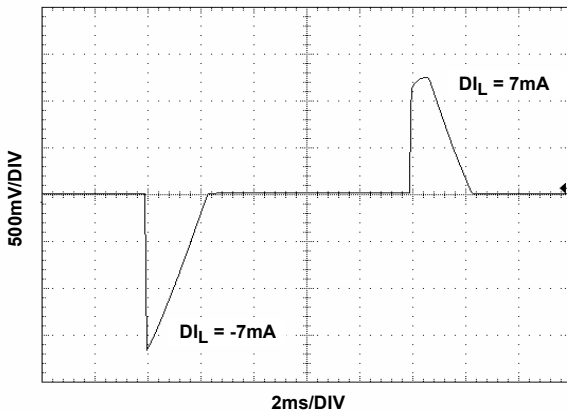

FIGURE 64. LOAD TRANSIENT RESPONSE

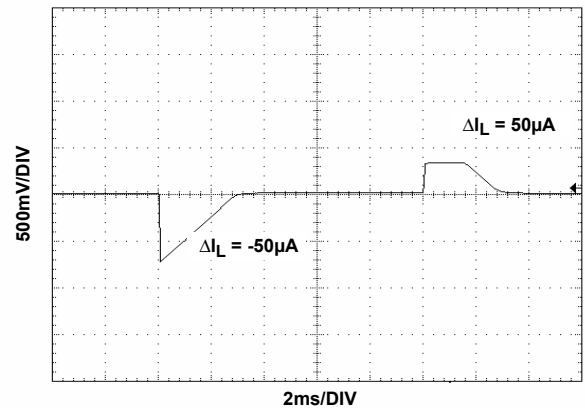

FIGURE 65. LOAD TRANSIENT RESPONSE

Typical Performance Curves, $V_{OUT} = 2.048V$

specified. (Continued)

$V_{IN} = 3.0V, I_{OUT} = 0mA, T_A = +25^\circ C$ unless otherwise specified.

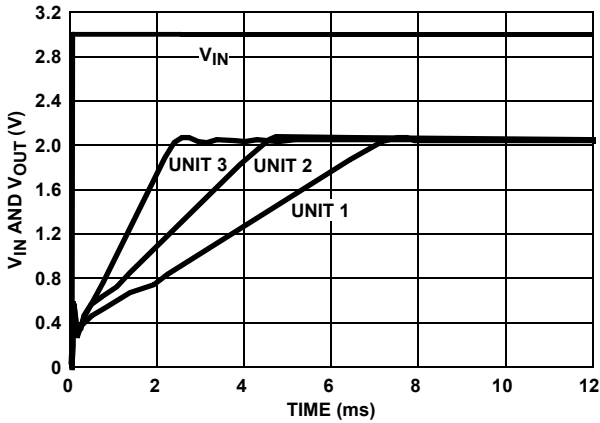

FIGURE 66. TURN-ON TIME (+25°C)

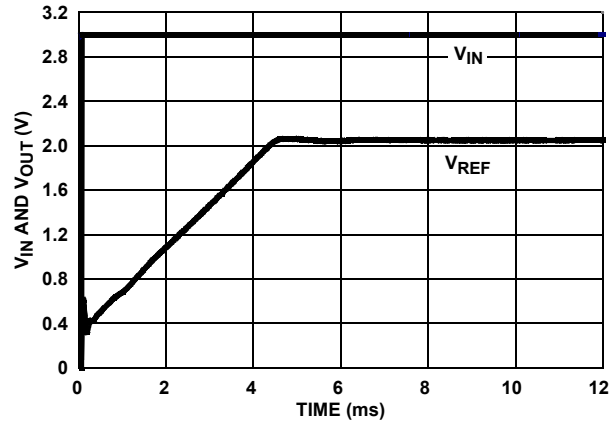

FIGURE 67. TURN-ON TIME (+25°C)

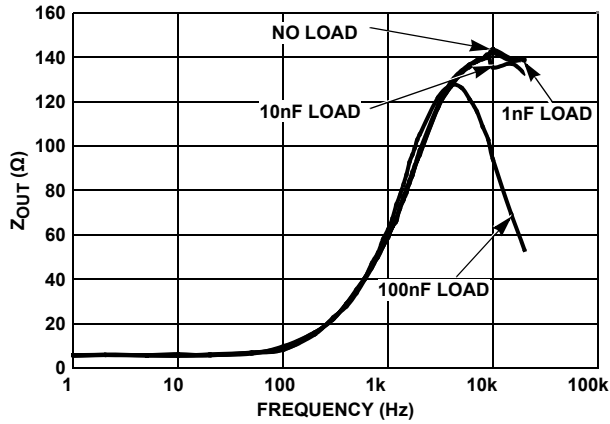

FIGURE 68. Z_{OUT} vs FREQUENCY

Typical Performance Characteristic Curves, $V_{OUT} = 2.50V$ $V_{IN} = 3.0V, I_{OUT} = 0mA,$

$T_A = +25^\circ C$ unless otherwise specified.

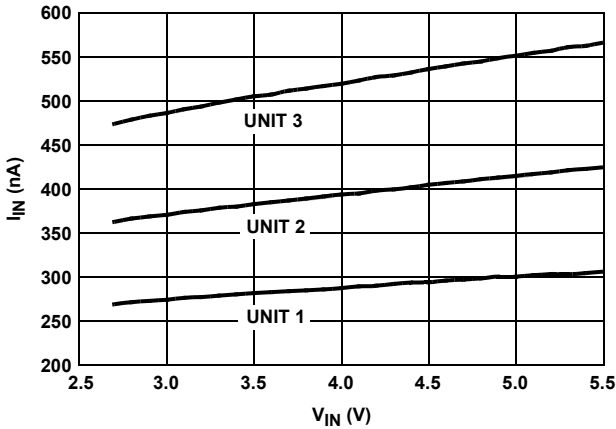

FIGURE 69. I_{IN} vs V_{IN} , 3 UNITS

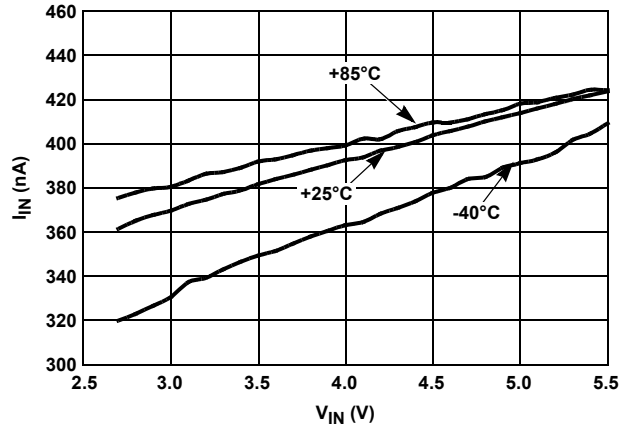

FIGURE 70. I_{IN} vs V_{IN} OVER-TEMPERATURE

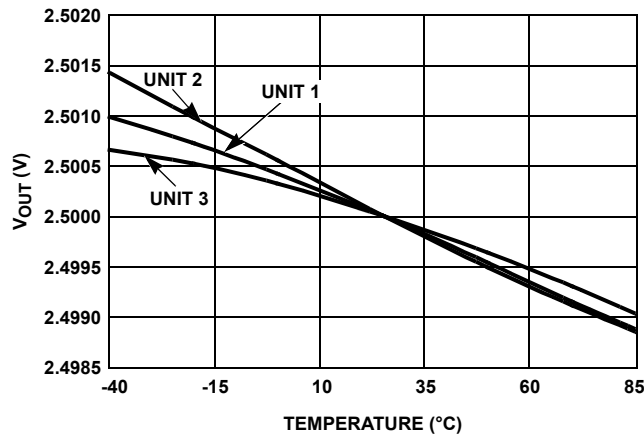

FIGURE 71. V_{OUT} vs TEMPERATURE NORMALIZED TO $+25^\circ C$

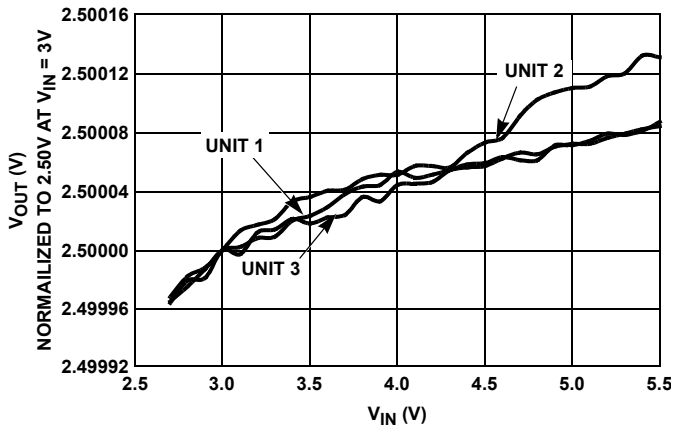

FIGURE 72. LINE REGULATION, 3 UNITS

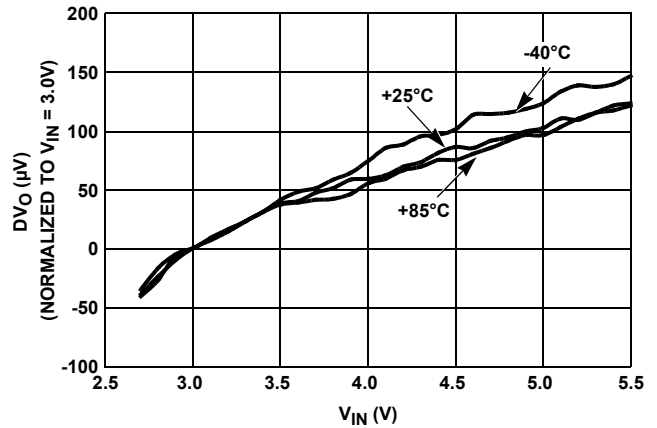

FIGURE 73. LINE REGULATION OVER-TEMPERATURE

Typical Performance Characteristic Curves, $V_{OUT} = 2.50V$ $V_{IN} = 3.0V, I_{OUT} = 0mA,$
 $T_A = +25^\circ C$ unless otherwise specified. (Continued)

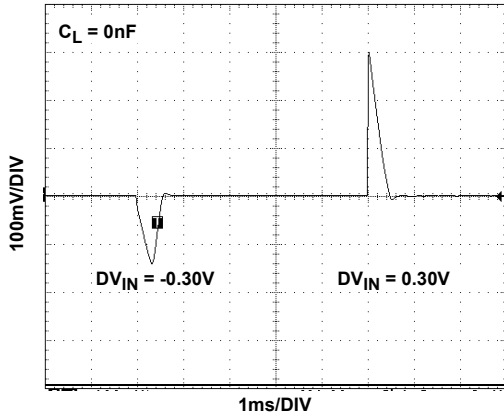

FIGURE 74. LINE TRANSIENT RESPONSE

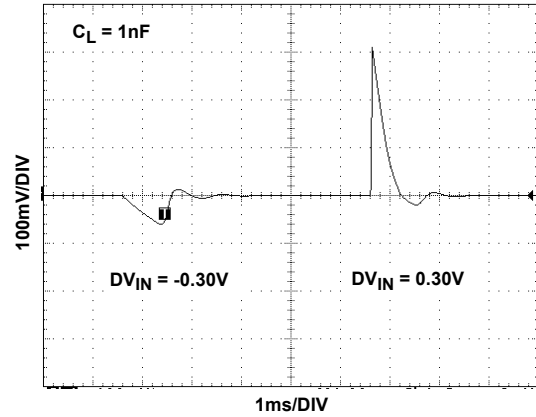

FIGURE 75. LINE TRANSIENT RESPONSE

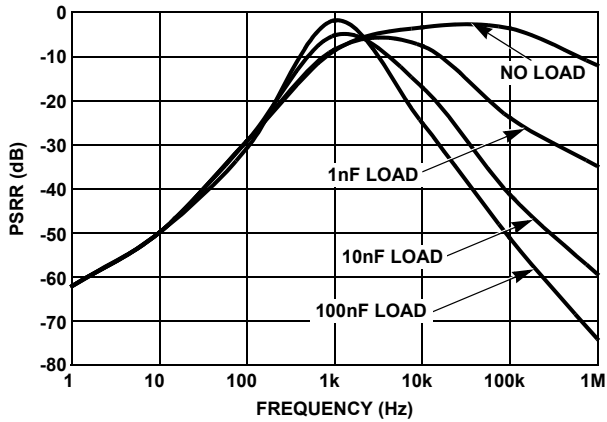

FIGURE 76. PSRR vs CAPACITIVE LOAD

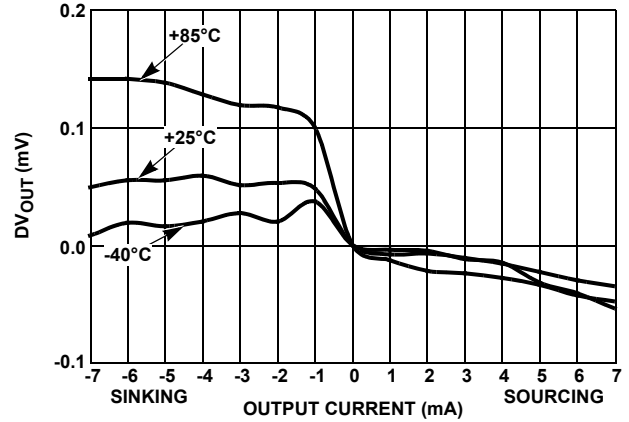

FIGURE 77. LOAD REGULATION OVER-TEMPERATURE

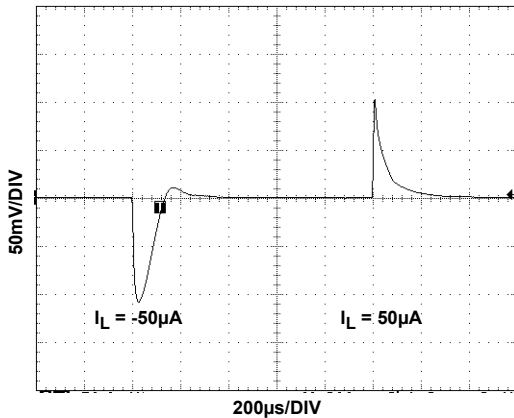

FIGURE 78. LOAD TRANSIENT RESPONSE

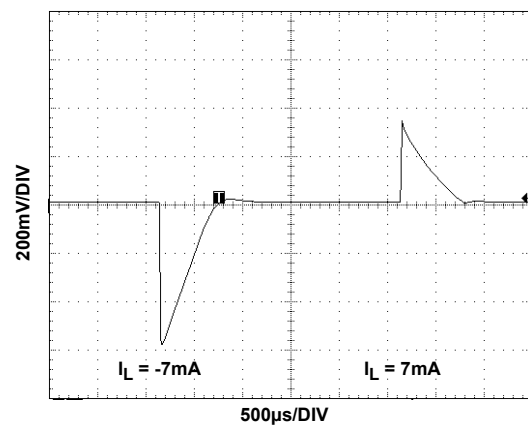

FIGURE 79. LOAD TRANSIENT RESPONSE

Typical Performance Characteristic Curves, $V_{OUT} = 2.50V$ $V_{IN} = 3.0V, I_{OUT} = 0mA,$
 $T_A = +25^\circ C$ unless otherwise specified. (Continued)

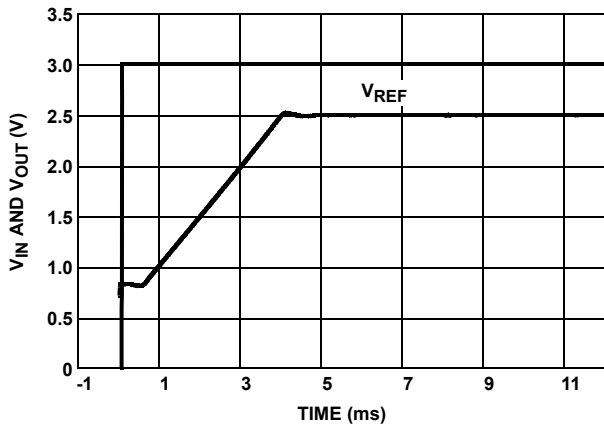

FIGURE 80. TURN-ON TIME (+25°C)

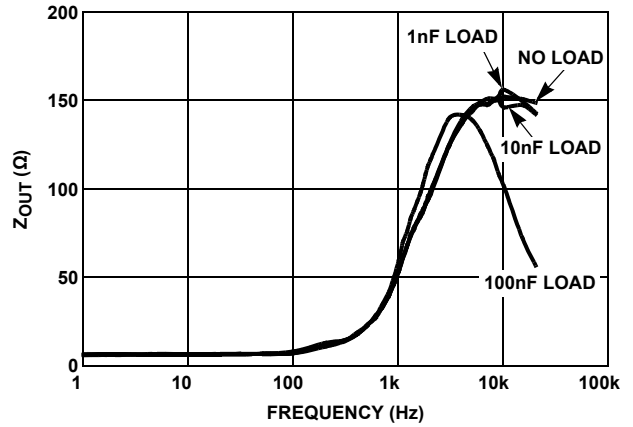

FIGURE 81. Z_{OUT} vs FREQUENCY

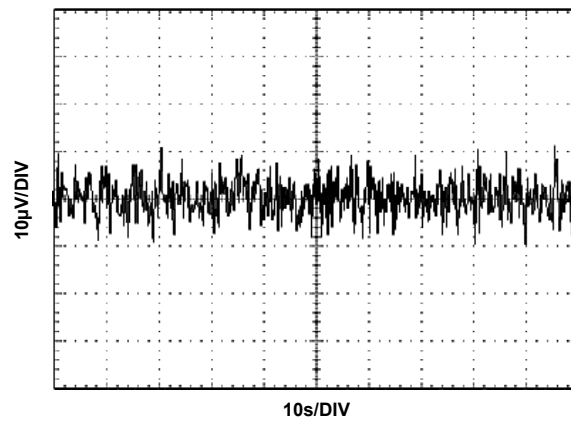

FIGURE 82. V_{OUT} NOISE

Typical Performance Characteristic Curves, $V_{OUT} = 3.0V$ $V_{IN} = 5.0V, I_{OUT} = 0mA,$

$T_A = +25^\circ C$ unless otherwise specified.

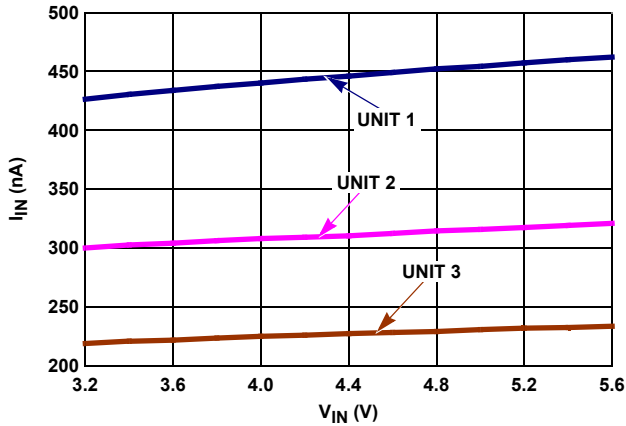

FIGURE 83. I_{IN} vs V_{IN} , 3 UNITS

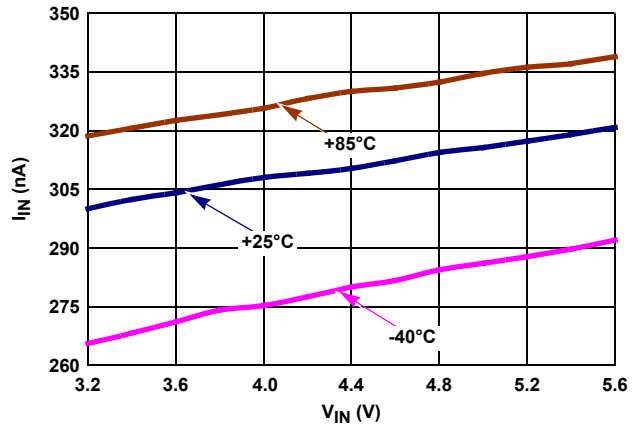

FIGURE 84. I_{IN} vs V_{IN} OVER-TEMPERATURE

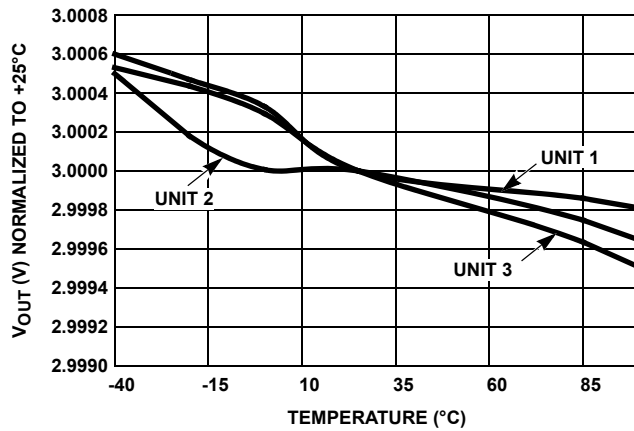

FIGURE 85. V_{OUT} vs TEMPERATURE NORMALIZED TO $+25^\circ C$

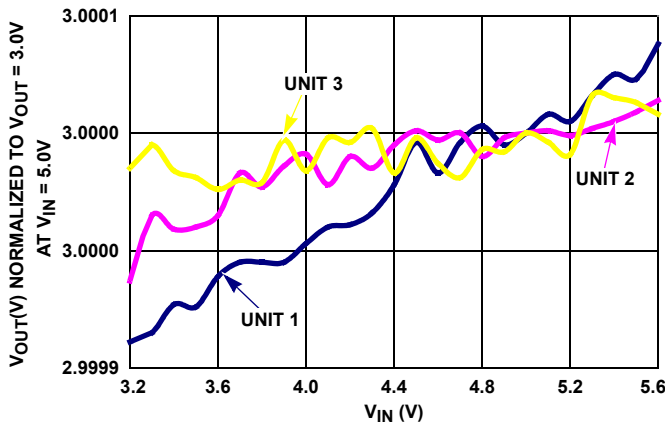

FIGURE 86. LINE REGULATION (3 REPRESENTATIVE UNITS)

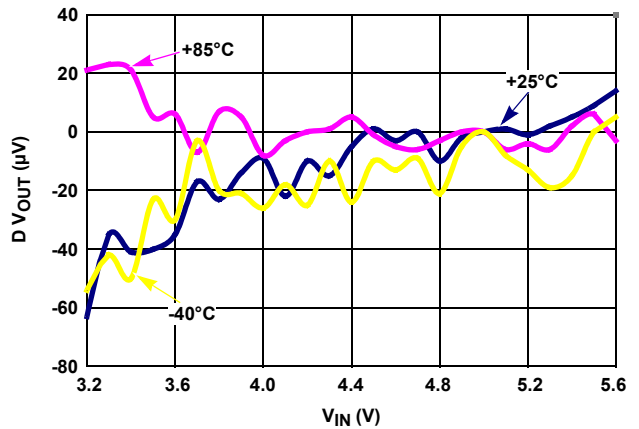

FIGURE 87. LINE REGULATION OVER-TEMPERATURE

Typical Performance Characteristic Curves, $V_{OUT} = 3.0V$ $V_{IN} = 5.0V, I_{OUT} = 0mA,$
 $T_A = +25^\circ C$ unless otherwise specified. (Continued)

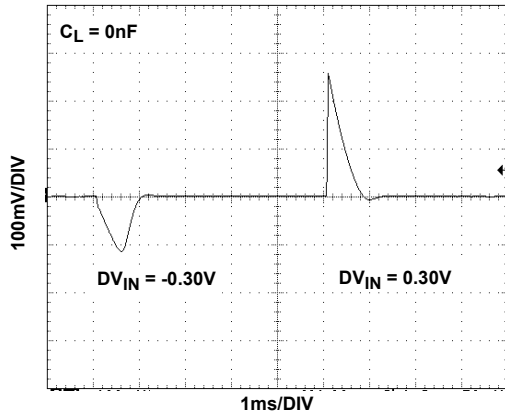

FIGURE 88. LINE TRANSIENT RESPONSE

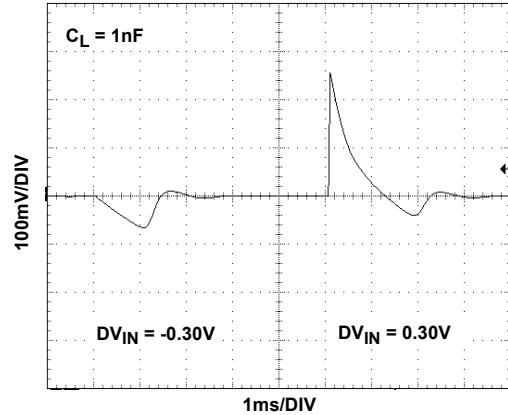

FIGURE 89. LINE TRANSIENT RESPONSE

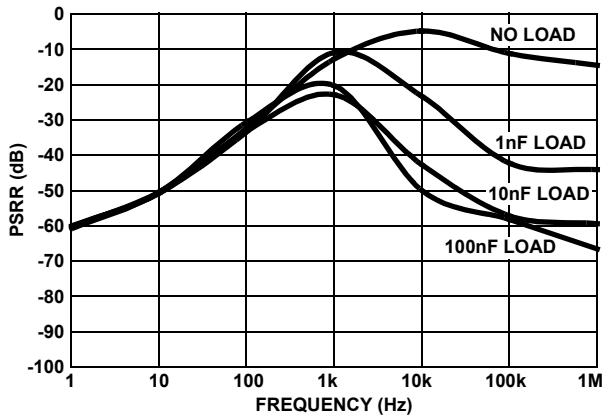

FIGURE 90. PSRR vs CAPACITIVE LOAD

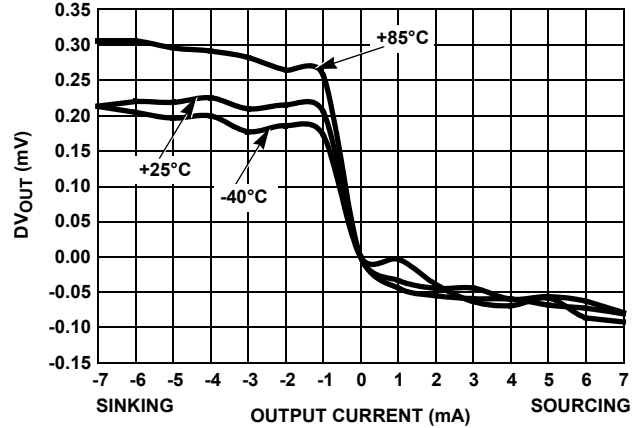

FIGURE 91. LOAD REGULATION OVER-TEMPERATURE

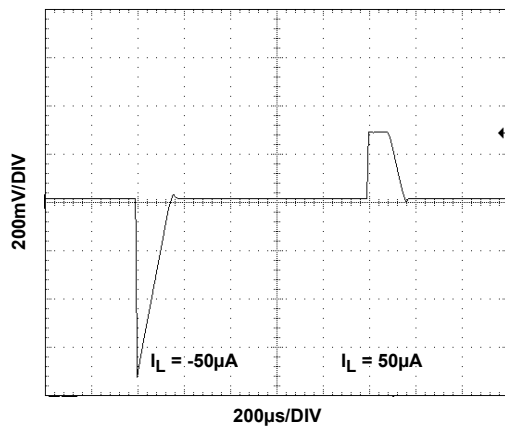

FIGURE 92. LOAD TRANSIENT RESPONSE

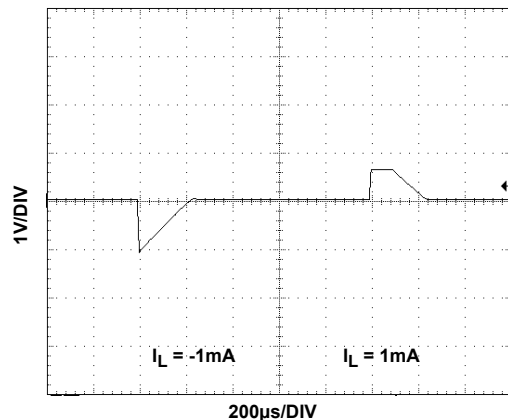

FIGURE 93. LOAD TRANSIENT RESPONSE

Typical Performance Characteristic Curves, $V_{OUT} = 3.0V$ $V_{IN} = 5.0V, I_{OUT} = 0mA,$
 $T_A = +25^\circ C$ unless otherwise specified. (Continued)

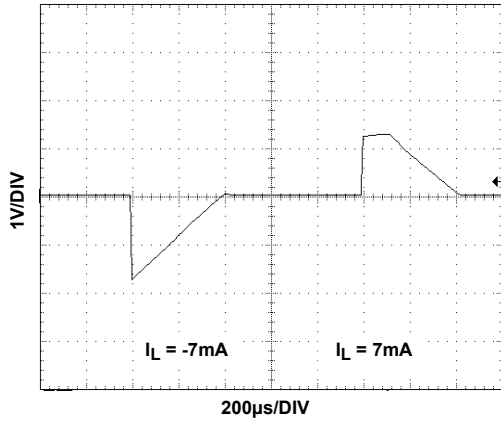

FIGURE 94. LOAD TRANSIENT RESPONSE

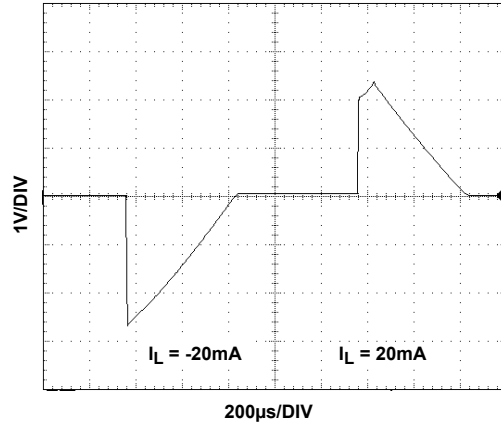

FIGURE 95. LOAD TRANSIENT RESPONSE

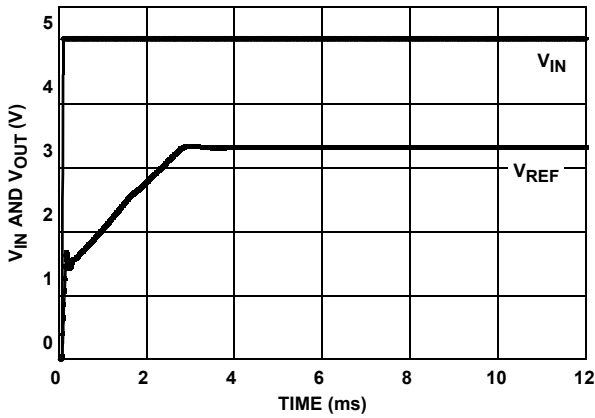

FIGURE 96. TURN-ON TIME (+25°C)

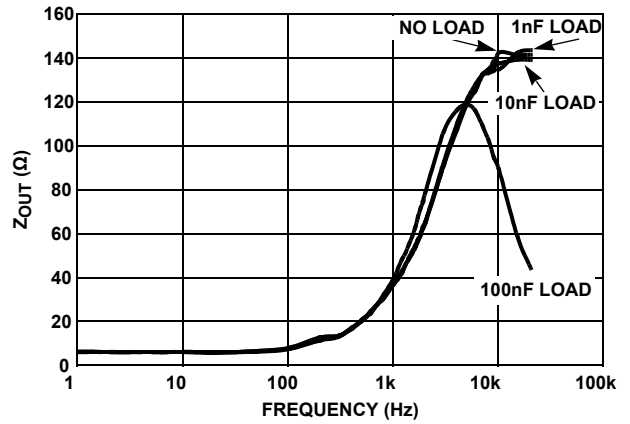

FIGURE 97. Z_{OUT} vs FREQUENCY

Typical Performance Characteristic Curves, $V_{OUT} = 3.3V$ $V_{IN} = 5.0V, I_{OUT} = 0mA,$
 $T_A = +25^\circ C$ unless otherwise specified.

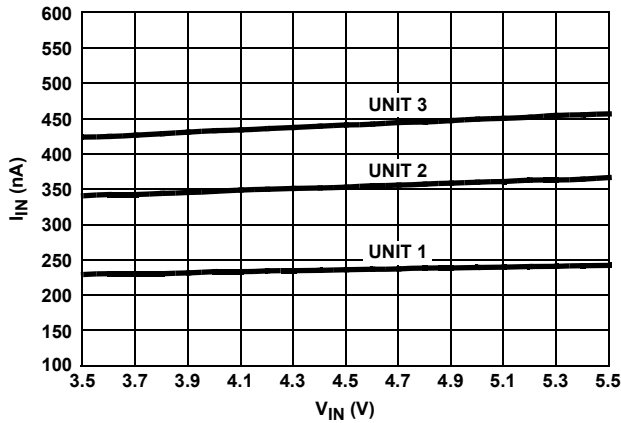

FIGURE 98. I_{IN} vs V_{IN} , 3 UNITS

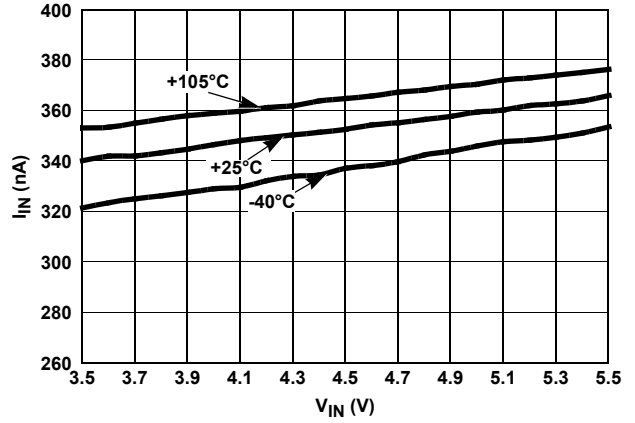

FIGURE 99. I_{IN} vs V_{IN} OVER-TEMPERATURE

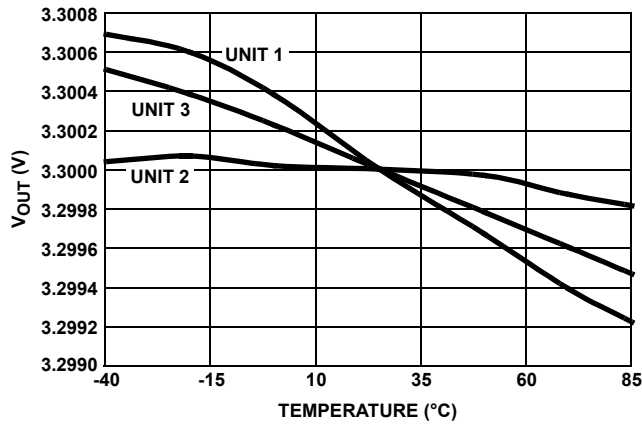

FIGURE 100. V_{OUT} vs TEMPERATURE NORMALIZED TO $+25^\circ C$

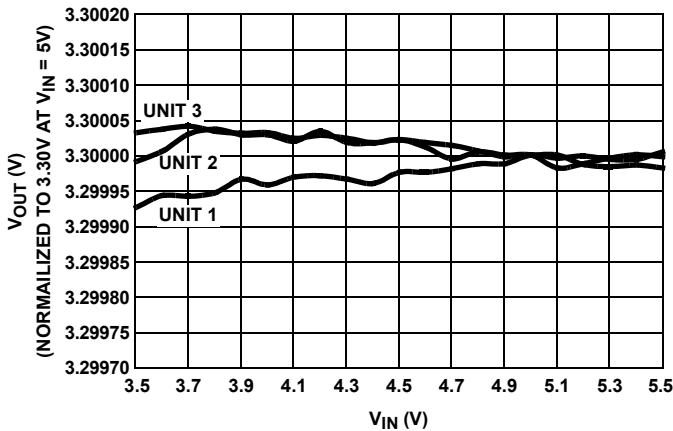

FIGURE 101. LINE REGULATION, 3 UNITS

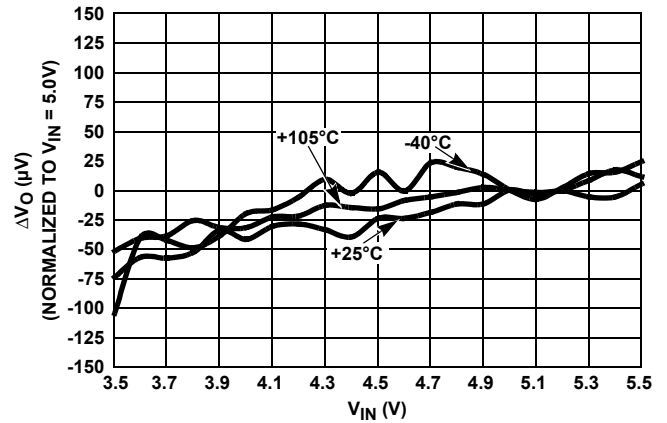

FIGURE 102. LINE REGULATION OVER-TEMPERATURE

Typical Performance Characteristic Curves, $V_{OUT} = 3.3V$ $V_{IN} = 5.0V, I_{OUT} = 0mA,$
 $T_A = +25^\circ C$ unless otherwise specified. (Continued)

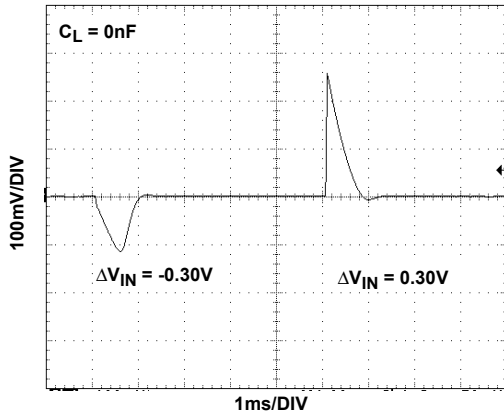

FIGURE 103. LINE TRANSIENT RESPONSE

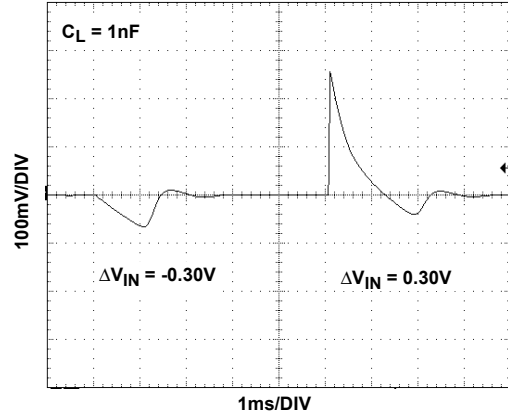

FIGURE 104. LINE TRANSIENT RESPONSE

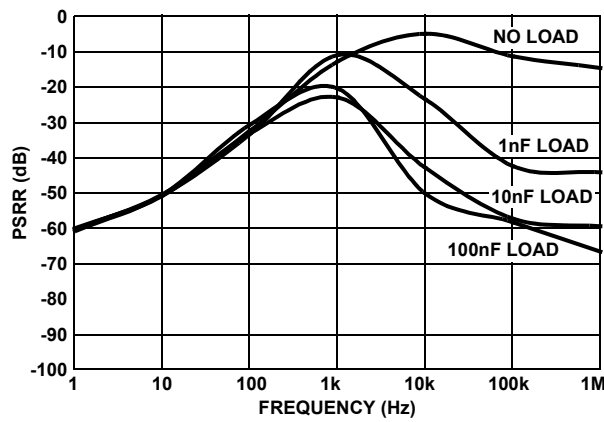

FIGURE 105. PSRR vs CAPACITIVE LOAD

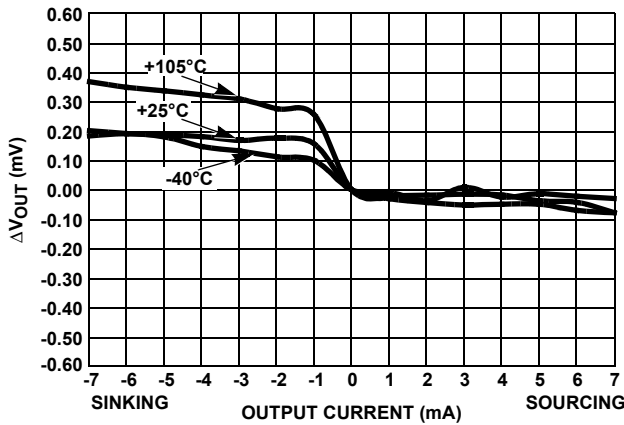

FIGURE 106. LOAD REGULATION

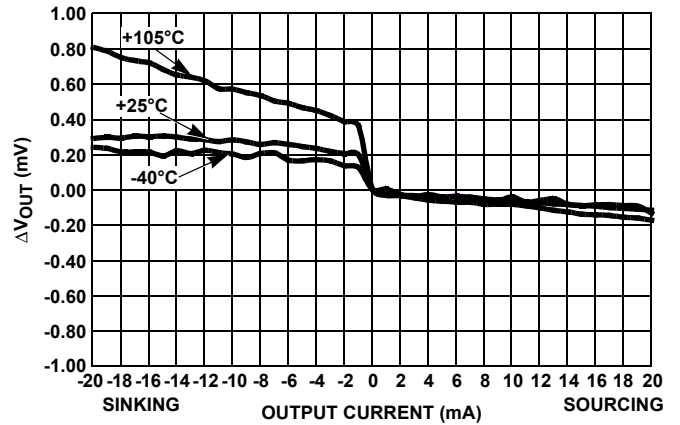

FIGURE 107. LOAD REGULATION OVER-TEMPERATURE

Typical Performance Characteristic Curves, $V_{OUT} = 3.3V$ $V_{IN} = 5.0V, I_{OUT} = 0mA,$
 $T_A = +25^\circ C$ unless otherwise specified. (Continued)

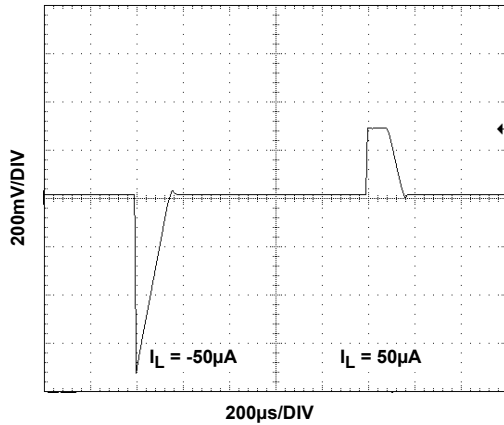

FIGURE 108. LOAD TRANSIENT RESPONSE

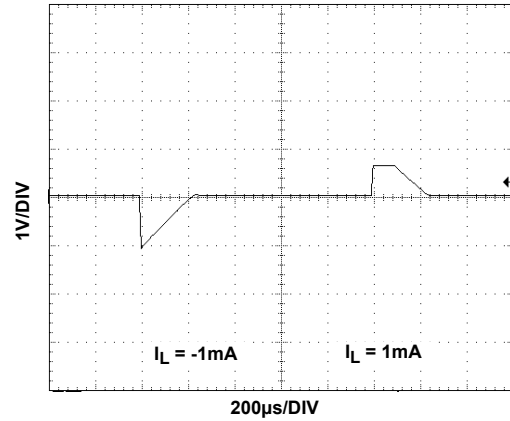

FIGURE 109. LOAD TRANSIENT RESPONSE

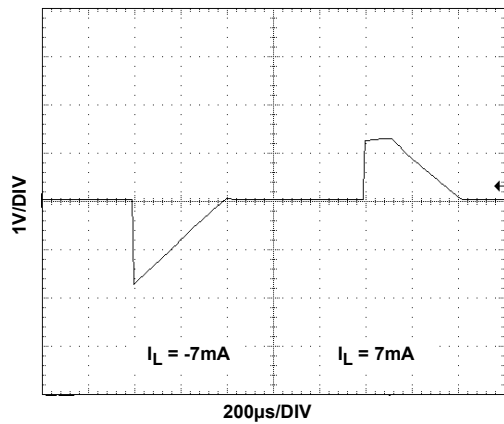

FIGURE 110. LOAD TRANSIENT RESPONSE

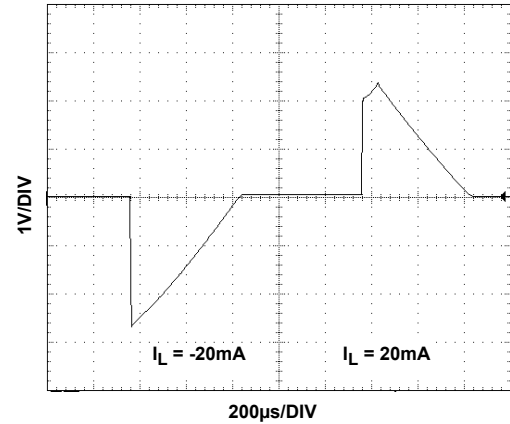

FIGURE 111. LOAD TRANSIENT RESPONSE

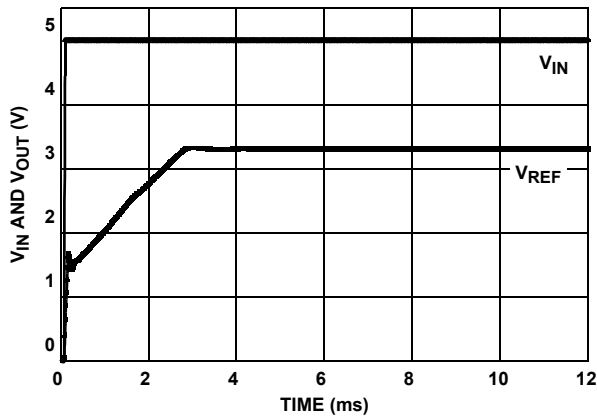

FIGURE 112. TURN-ON TIME (+25°C)

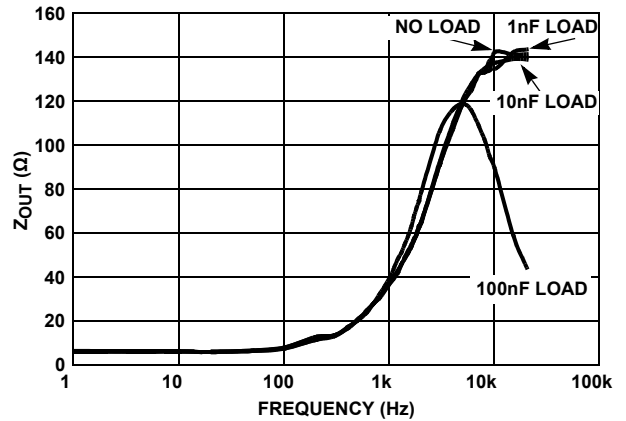

FIGURE 113. Z_{OUT} vs FREQUENCY

High Current Application

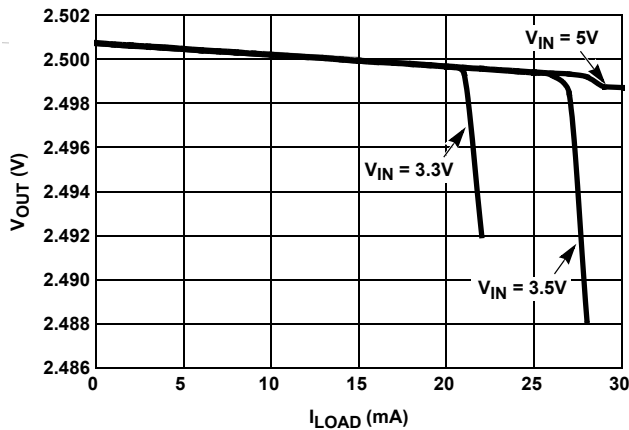

FIGURE 114. DIFFERENT V_{IN} AT ROOM TEMPERATURE

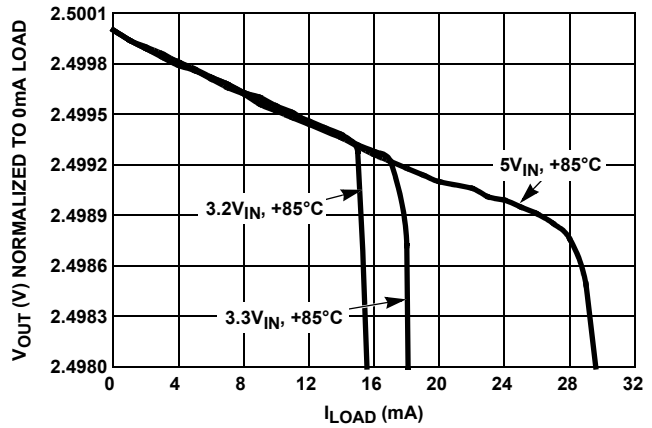

FIGURE 115. DIFFERENT V_{IN} AT HIGH TEMPERATURE

Applications Information

FGA Technology

The ISL60002 series of voltage references use the floating gate technology to create references with very low drift and supply current. Essentially, the charge stored on a floating gate cell is set precisely in manufacturing. The reference voltage output itself is a buffered version of the floating gate voltage. The resulting reference device has excellent characteristics, that are unique in the industry: very low temperature drift, high initial accuracy, and almost zero supply current. Also, the reference voltage itself is not limited by voltage bandgaps or zener settings, so a wide range of reference voltages can be programmed (standard voltage settings are provided, but customer-specific voltages are available).

The process used for these reference devices is a floating gate CMOS process, and the amplifier circuitry uses CMOS transistors for amplifier and output transistor circuitry. While providing excellent accuracy, there are limitations in output noise level and load regulation due to the MOS device characteristics. These limitations are addressed with circuit techniques discussed in other sections.

Nanopower Operation

Reference devices achieve their highest accuracy when powered up continuously, and after initial stabilization has taken place. This drift can be eliminated by leaving the power on continuously.

The ISL60002 is the first high precision voltage reference with ultra low power consumption that makes it possible to leave power on continuously in battery operated circuits. The ISL60002 consumes extremely low supply current due to the proprietary FGA technology. Supply current at room temperature is typically 350nA, which is 1 to 2 orders of magnitude lower than competitive devices. Application circuits using battery power benefit greatly from having an accurate, stable reference that essentially presents no load to the battery.

In particular, battery powered data converter circuits that would normally require the entire circuit to be disabled when not in use, can remain powered up between conversions as shown in

Figure 116. Data acquisition circuits providing 12 to 24 bits of accuracy can operate with the reference device continuously biased with no power penalty, providing the highest accuracy and lowest possible long term drift.

Other reference devices consuming higher supply currents need to be disabled in between conversions to conserve battery capacity. Absolute accuracy suffers as the device is biased and requires time to settle to its final value, or, may not actually settle to a final value as power on time can be short.

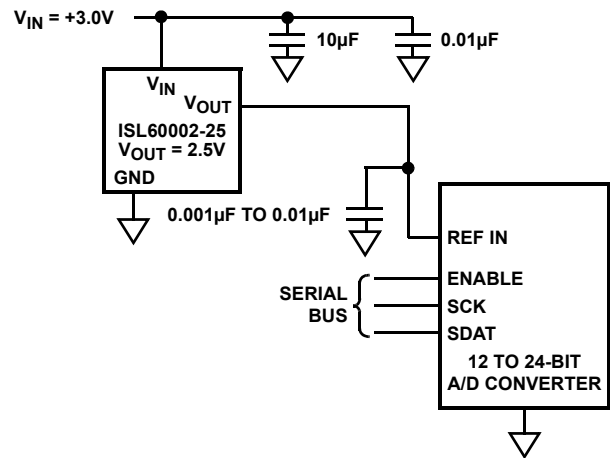

FIGURE 116.

Board Mounting Considerations

For applications requiring the highest accuracy, board mounting location should be reviewed. Placing the device in areas subject to slight twisting can cause degradation of the accuracy of the reference voltage due to die stresses. It is normally best to place the device near the edge of a board, or the shortest side, as the axis of bending is most limited at that location. Obviously mounting the device on flexprint or extremely thin PC material causes loss of reference accuracy.

Board Assembly Considerations

FGA references provide high accuracy and low temperature drift but some PC board assembly precautions are necessary. Normal output voltage shifts of 100 μ V to 1mV can be expected with Pb-free reflow profiles. Avoid excessive heat or extended exposure to high reflow or wave solder temperatures. This can reduce device initial accuracy.

Post-assembly X-ray inspection can also lead to permanent changes in device output voltage and should be minimized or avoided. If X-ray inspection is required, it is advisable to monitor the reference output voltage to verify excessive shift has not occurred. If large amounts of shift are observed, it is best to add an X-ray shield consisting of thin zinc (300 μ m) sheeting to allow clear imaging, yet block X-ray energy that affects the FGA reference.

Special Applications Considerations

In addition to post-assembly examination, there are also other X-ray sources that can affect the FGA reference long term accuracy. Airport screening machines contain X-rays and have a cumulative effect on the voltage reference output accuracy. Carry-on luggage screening uses low level X-rays and is not a major source of output voltage shift, however, if a product is expected to pass through that type of screening over 100 times, consider shielding with copper or aluminum. Checked luggage X-rays are higher intensity and can cause output voltage shift in much fewer passes, therefore devices expected to go through those machines should definitely consider shielding. Note that just two layers of 1/2 ounce copper planes reduce the received dose by over 90%. The leadframe for the device that is on the bottom also provides similar shielding.

If a device is expected to pass through luggage X-ray machines numerous times, it is advised to mount a 2-layer (minimum) PC board on the top, and along with a ground plane underneath effectively shields it from 50 to 100 passes through the machine. Because these machines vary in X-ray dose delivered, it is difficult to produce an accurate maximum pass recommendation.

Noise Performance and Reduction

The output noise voltage in a 0.1Hz to 10Hz bandwidth is typically 30 μ V_{p-p}. Noise in the 10kHz to 1MHz bandwidth is approximately 400 μ V_{p-p} with no capacitance on the output, as shown in [Figure 117](#). These noise measurements are made with a 2 decade bandpass filter made of a 1-pole high-pass filter with a corner frequency at 1/10 of the center frequency and 1-pole low-pass filter with a corner frequency at 10 times the center frequency. [Figure 117](#) also shows the noise in the 10kHz to 1MHz band can be reduced to about 50 μ V_{p-p} using a 0.001 μ F capacitor on the output. Noise in the 1kHz to 100kHz band can be further reduced using a 0.1 μ F capacitor on the output, but noise in the 1Hz to 100Hz band increases due to instability of the very low power amplifier with a 0.1 μ F capacitance load. For load capacitances above 0.001 μ F the noise reduction network shown in [Figure 118](#) is recommended. This network reduces noise significantly over the full bandwidth. As shown in [Figure 117](#), noise is reduced to less than 40 μ V_{p-p} from 1Hz to 1MHz using this network with a 0.01 μ F capacitor and a 2k Ω resistor in series with a 10 μ F capacitor.

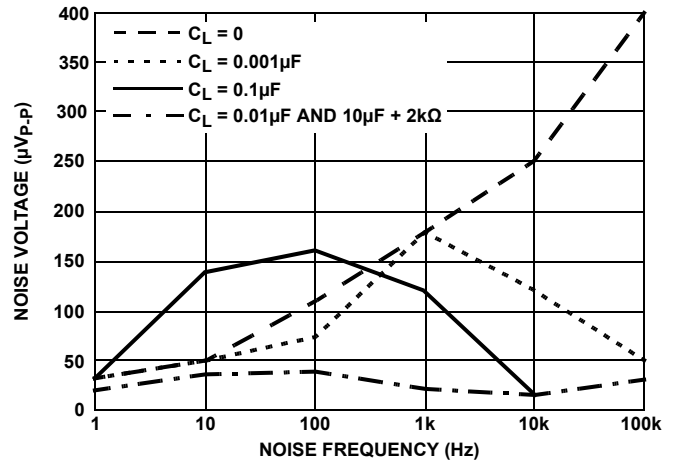

FIGURE 117. NOISE REDUCTION

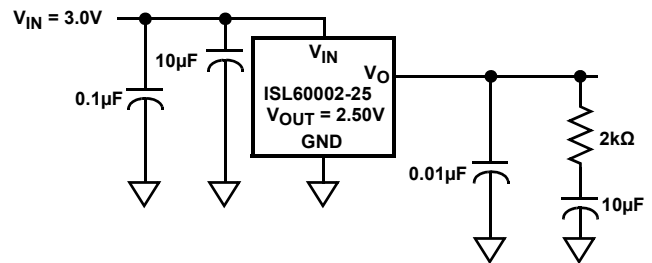

FIGURE 118. NOISE REDUCTION NETWORK

Turn-On Time

The ISL60002 devices have ultra-low supply current and therefore the time to bias up internal circuitry to final values is longer than with higher power references. Normal turn-on time is typically 4ms. This is shown in [Figure 119](#). Because devices can vary in supply current down to >300nA, turn-on time can last up to about 12ms. Care should be taken in system design to include this delay before measurements or conversions are started.

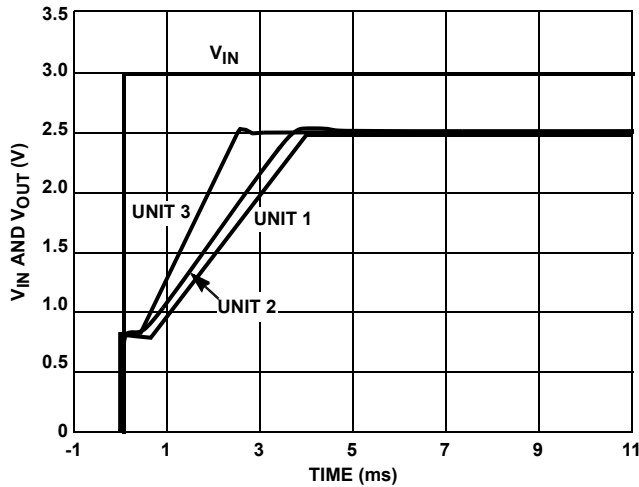
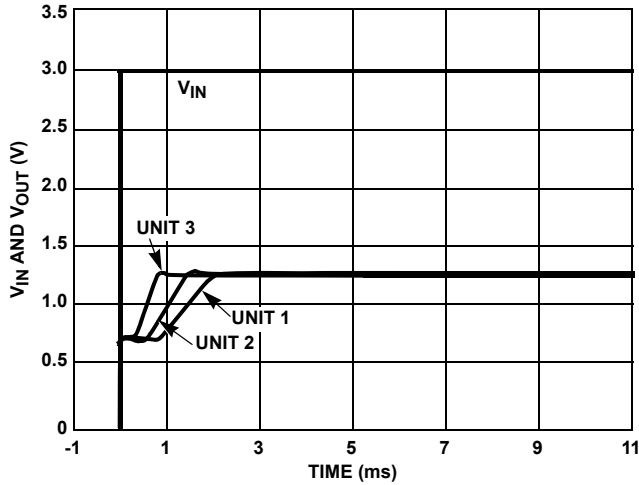

FIGURE 119. TURN-ON TIME

Temperature Coefficient

The limits stated for temperature coefficient (tempco) are governed by the method of measurement. The overwhelming standard for specifying the temperature drift of a reference is to measure the reference voltage at two temperatures, take the total variation, (V_{HIGH} - V_{LOW}), and divide by the temperature extremes of measurement (T_{HIGH} - T_{LOW}). The result is divided by the nominal reference voltage (at T = +25°C) and multiplied by 10⁶ to yield ppm/°C. This is the “Box” method for specifying temperature coefficient.

Typical Application Circuits

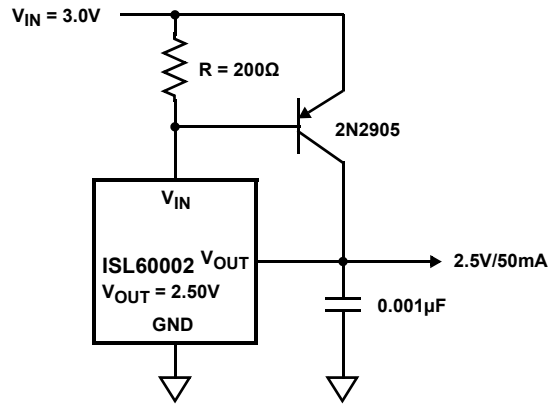

FIGURE 120. PRECISION 2.5V 50mA REFERENCE

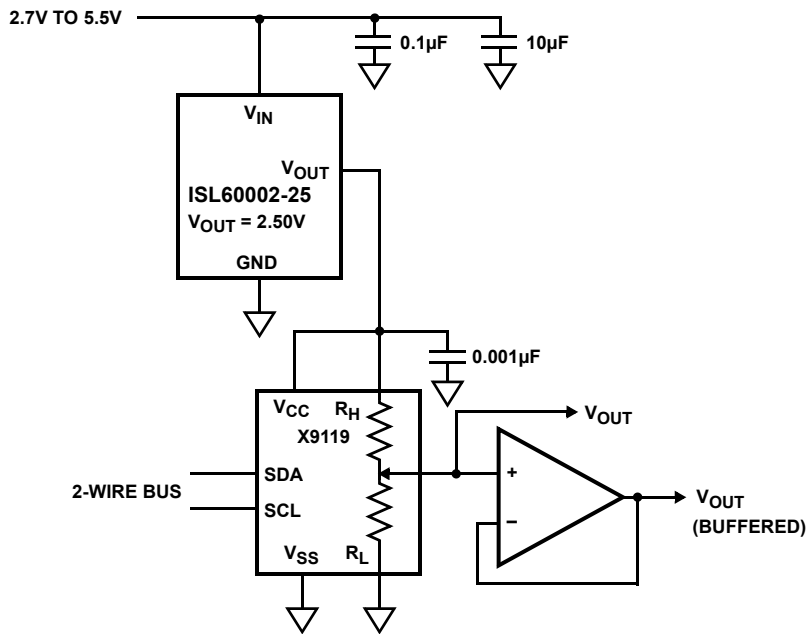

FIGURE 121. 2.5V FULL SCALE LOW-DRIFT 10-BIT ADJUSTABLE VOLTAGE SOURCE

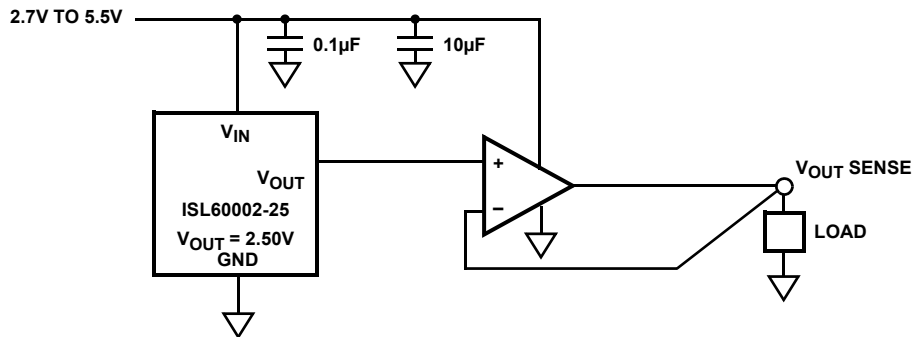

FIGURE 122. KELVIN SENSED LOAD

Revision History The revision history provided is for informational purposes only and is believed to be accurate, but not warranted. Please visit our website to make sure you have the latest revision.

DATE	REVISION	CHANGE
Jan 14, 2019	FN8082.23	Page 1 Features - corrected ESD rating listed as 5.5V (Human Body Model) to 5.5kV. Changed the ESD HBM in Abs Max section on page 5 from 5500V to 5.5kV. Updated Disclaimer.
Mar 9, 2018	FN8082.22	Updated Note 6 by fixing the induced error caused from importing new formatting, changed 70mA to 70µA. Updated Noise Performance and Reduction section. Removed About Intersil section and updated disclaimer.
Nov 17, 2016	FN8082.21	Updated Related Literature on page 1 to new standard. Updated Ordering Information table - added Tape and Real quantity column.
Jan 8, 2015	FN8082.20	-Updated ordering information table on page 3 by removing withdrawn part numbers: ISL60002BIH320Z, ISL60002BIH325Z, ISL60002CIH320Z, ISL60002DAH333Z. - Changed the y-axis units on Figure 55, on page 21 from 5mV/DIV to 5µV/DIV. Added revision history and about Intersil verbiage. Updated POD from P3.064 to P3.064A. Changes are as follows: Detail A changes: 0.085 - 0.19 to 0.13 ±0.05 Removed 0.25 above Gauge Plane 0.38±0.10 to 0.31 ±0.10 Side View changes: 0.95±0.07 to 0.91 ±0.03

Package Outline Drawing

P3.064A

3 LEAD SMALL OUTLINE TRANSISTOR PLASTIC PACKAGE (SOT23-3)

Rev 0, 7/14

For the most recent package outline drawing, see [P3.064A](#).

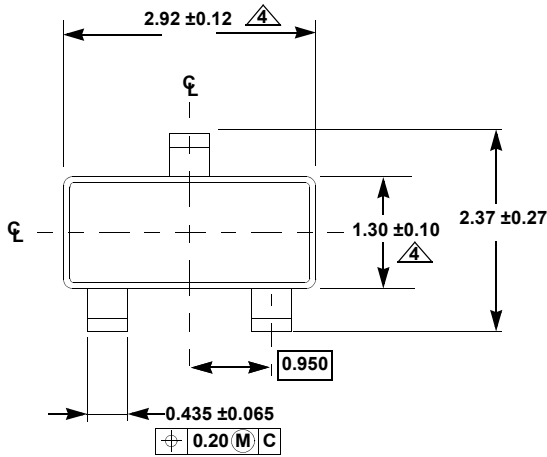

TOP VIEW

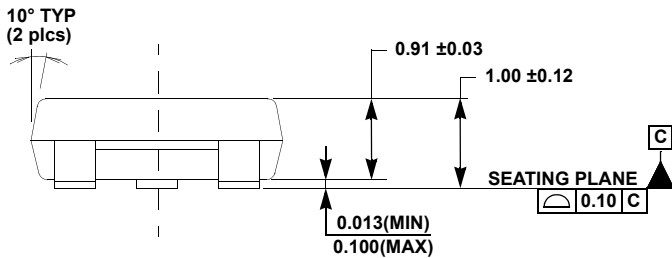
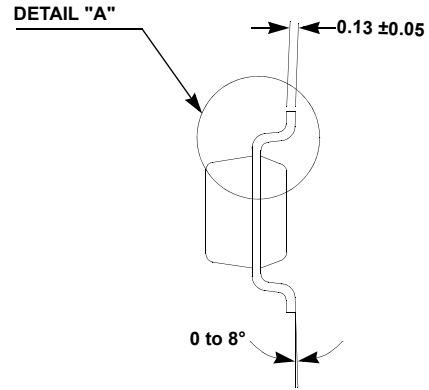

SIDE VIEW

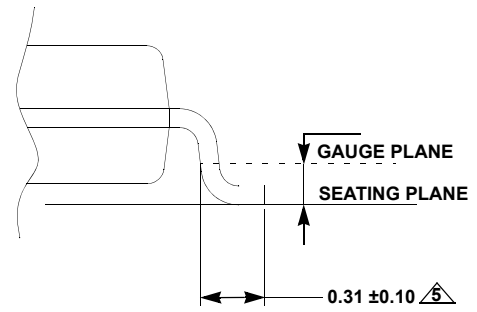

DETAIL "A"

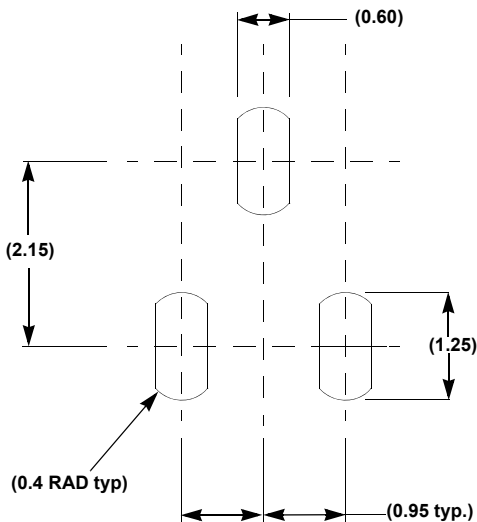

TYPICAL RECOMMENDED LAND PATTERN

NOTES:

1. Dimensions are in millimeters. Dimensions in () for Reference Only.
2. Dimensioning and tolerancing conform to ASME Y14.5M-1994.
3. Reference JEDEC TO-236.
4. Dimension does not include interlead flash or protrusions. Interlead flash or protrusions shall not exceed 0.25mm per side.
5. Footlength is measured at reference to gauge plane.

Notice

1. Descriptions of circuits, software and other related information in this document are provided only to illustrate the operation of semiconductor products and application examples. You are fully responsible for the incorporation or any other use of the circuits, software, and information in the design of your product or system. Renesas Electronics disclaims any and all liability for any losses and damages incurred by you or third parties arising from the use of these circuits, software, or information.
 2. Renesas Electronics hereby expressly disclaims any warranties against and liability for infringement or any other claims involving patents, copyrights, or other intellectual property rights of third parties, by or arising from the use of Renesas Electronics products or technical information described in this document, including but not limited to, the product data, drawings, charts, programs, algorithms, and application examples.
 3. No license, express, implied or otherwise, is granted hereby under any patents, copyrights or other intellectual property rights of Renesas Electronics or others.
 4. You shall not alter, modify, copy, or reverse engineer any Renesas Electronics product, whether in whole or in part. Renesas Electronics disclaims any and all liability for any losses or damages incurred by you or third parties arising from such alteration, modification, copying or reverse engineering.
 5. Renesas Electronics products are classified according to the following two quality grades: "Standard" and "High Quality". The intended applications for each Renesas Electronics product depends on the product's quality grade, as indicated below.
 - "Standard": Computers; office equipment; communications equipment; test and measurement equipment; audio and visual equipment; home electronic appliances; machine tools; personal electronic equipment; industrial robots; etc.
 - "High Quality": Transportation equipment (automobiles, trains, ships, etc.); traffic control (traffic lights); large-scale communication equipment; key financial terminal systems; safety control equipment; etc.Unless expressly designated as a high reliability product or a product for harsh environments in a Renesas Electronics data sheet or other Renesas Electronics document, Renesas Electronics products are not intended or authorized for use in products or systems that may pose a direct threat to human life or bodily injury (artificial life support devices or systems; surgical implantations; etc.), or may cause serious property damage (space system; undersea repeaters; nuclear power control systems; aircraft control systems; key plant systems; military equipment; etc.). Renesas Electronics disclaims any and all liability for any damages or losses incurred by you or any third parties arising from the use of any Renesas Electronics product that is inconsistent with any Renesas Electronics data sheet, user's manual or other Renesas Electronics document.
 6. When using Renesas Electronics products, refer to the latest product information (data sheets, user's manuals, application notes, "General Notes for Handling and Using Semiconductor Devices" in the reliability handbook, etc.), and ensure that usage conditions are within the ranges specified by Renesas Electronics with respect to maximum ratings, operating power supply voltage range, heat dissipation characteristics, installation, etc. Renesas Electronics disclaims any and all liability for any malfunctions, failure or accident arising out of the use of Renesas Electronics products outside of such specified ranges.
 7. Although Renesas Electronics endeavors to improve the quality and reliability of Renesas Electronics products, semiconductor products have specific characteristics, such as the occurrence of failure at a certain rate and malfunctions under certain use conditions. Unless designated as a high reliability product or a product for harsh environments in a Renesas Electronics data sheet or other Renesas Electronics document, Renesas Electronics products are not subject to radiation resistance design. You are responsible for implementing safety measures to guard against the possibility of bodily injury, injury or damage caused by fire, and/or danger to the public in the event of a failure or malfunction of Renesas Electronics products, such as safety design for hardware and software, including but not limited to redundancy, fire control and malfunction prevention, appropriate treatment for aging degradation or any other appropriate measures. Because the evaluation of microcomputer software alone is very difficult and impractical, you are responsible for evaluating the safety of the final products or systems manufactured by you.
 8. Please contact a Renesas Electronics sales office for details as to environmental matters such as the environmental compatibility of each Renesas Electronics product. You are responsible for carefully and sufficiently investigating applicable laws and regulations that regulate the inclusion or use of controlled substances, including without limitation, the EU RoHS Directive, and using Renesas Electronics products in compliance with all these applicable laws and regulations. Renesas Electronics disclaims any and all liability for damages or losses occurring as a result of your noncompliance with applicable laws and regulations.
 9. Renesas Electronics products and technologies shall not be used for or incorporated into any products or systems whose manufacture, use, or sale is prohibited under any applicable domestic or foreign laws or regulations. You shall comply with any applicable export control laws and regulations promulgated and administered by the governments of any countries asserting jurisdiction over the parties or transactions.
 10. It is the responsibility of the buyer or distributor of Renesas Electronics products, or any other party who distributes, disposes of, or otherwise sells or transfers the product to a third party, to notify such third party in advance of the contents and conditions set forth in this document.
 11. This document shall not be reprinted, reproduced or duplicated in any form, in whole or in part, without prior written consent of Renesas Electronics.
 12. Please contact a Renesas Electronics sales office if you have any questions regarding the information contained in this document or Renesas Electronics products.
- (Note1) "Renesas Electronics" as used in this document means Renesas Electronics Corporation and also includes its directly or indirectly controlled subsidiaries.
- (Note2) "Renesas Electronics product(s)" means any product developed or manufactured by or for Renesas Electronics.

(Rev.4.0-1 November 2017)

Corporate Headquarters

TOYOSU FORESIA, 3-2-24 Toyosu,
Koto-ku, Tokyo 135-0061, Japan
www.renesas.com

Trademarks

Renesas and the Renesas logo are trademarks of Renesas Electronics Corporation. All trademarks and registered trademarks are the property of their respective owners.

Contact Information

For further information on a product, technology, the most up-to-date version of a document, or your nearest sales office, please visit:
www.renesas.com/contact/

Mouser Electronics

Authorized Distributor

Click to View Pricing, Inventory, Delivery & Lifecycle Information:

Renesas Electronics:

[ISL60002BAH333Z-T7A](#) [ISL60002BAH333Z-TK](#) [ISL60002BIH310Z-T7A](#) [ISL60002BIH310Z-TK](#) [ISL60002BIH311Z-TK](#) [ISL60002BIH312Z-TK](#) [ISL60002BIH318Z-TK](#) [ISL60002BIH320Z-T7A](#) [ISL60002BIH320Z-TK](#) [ISL60002BIH325Z-T7A](#) [ISL60002BIH325Z-TK](#) [ISL60002BIH326Z-TK](#) [ISL60002BIH330Z-TK](#) [ISL60002CAH333Z-TK](#) [ISL60002CIH310Z-TK](#) [ISL60002CIH311Z-TK](#) [ISL60002CIH312Z-TK](#) [ISL60002CIH318Z-TK](#) [ISL60002CIH320Z-TK](#) [ISL60002CIH325Z-T7A](#) [ISL60002CIH325Z-TK](#) [ISL60002CIH326Z-TK](#) [ISL60002CIH330Z-TK](#) [ISL60002DAH333Z-T7A](#) [ISL60002DAH333Z-TK](#) [ISL60002DIH310Z-T7A](#) [ISL60002DIH310Z-TK](#) [ISL60002DIH311Z-TK](#) [ISL60002DIH312Z-T7A](#) [ISL60002DIH312Z-TK](#) [ISL60002DIH318Z-TK](#) [ISL60002DIH320Z-TK](#) [ISL60002DIH325Z-T7A](#) [ISL60002DIH325Z-TK](#) [ISL60002DIH326Z-TK](#) [ISL60002DIH330Z-T7A](#) [ISL60002DIH330Z-TK](#)