

Battery Interconnects

Product Facts

- Total interface solution
- Current capacity — 7 Amps/ single contact at 30°C T-Rise
- Choice of right-angle or vertical mount headers with left, right or keyless polarization
- 5.0 mm pitch headers available for 7.2, 10.8, and 12.0 volt rechargeable batteries
- Receptacle connectors available with solder tails or weld tabs
- Consumer friendly mating/unmating of battery
- Produced under a Quality Management System certified to ISO 9001
- Blade Contacts for high durability
- Used Industry-wide for rechargeable battery I/O — in laptop computers
- Offered in a variety of key arrangements — for different voltage batteries
- 2.0 mm, 2.5 mm, 3.0 mm and 5.0 mm contact pitch batteries available
- MDI systems designed to mate at any angle
- Up to 7 Amps per contact
- Up to 2500 cycle durability
- Two pc tails per blade — for better current distribution



Since the introduction of the standard-size NiMH rechargeable battery to the computer and communications industries, Tyco Electronics has played a major role in the development and manufacture of reliable, high performance battery interconnect systems.

As the needs and applications of original equipment manufacturers have evolved, so have Tyco Electronics' battery interconnect systems. Today, we offer several types of connectors including:

- **Standard 5-position, 5.0 mm centerline assemblies**
- **Space efficient battery packs available at 2.0 mm, 2.5 mm, and 3.0 mm centerlines**

- **Multi-Directional Interconnection (MDI) systems**
- **Coin cell battery holders**

All battery interconnect assembly housings are made of high temperature, UL 94V-0 rated thermoplastic. Single contacts are rated at 7 Amps with a 30° T-Rise, and have an operating temperature rating of -30° to +70°C. These assemblies can be customized for various applications and are available with many keying and mounting options.

Tyco Electronics answers the need in the portable equipment market for a high density, robust, and versatile interconnection system with the Multi-Directional Interconnection

(MDI) System. This durable system, designed to permit mating/unmating at any angle between 0° and 90°, features AMP-DURAGOLD plated contacts for up to 2500 cycles.

Our coin-cell battery holders are ideal for a variety of electronic equipment needing a compact low wattage (typically less than 2 Watts) battery source. These holders are available in both horizontal and vertical mount. Surface-mount and re-flow compatible options are also ready to meet the newer PCB assembly requirements.

2.0 mm Pitch Battery Assemblies

2.0 mm Pitch Plug Assemblies

Material and Finish

Housing — Black thermoplastic resin, UL 94V-0 rated

Contacts — High conductivity copper alloy, gold plating

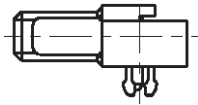
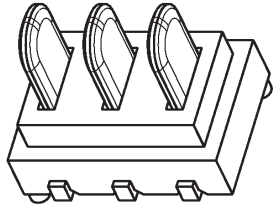

Retention Leg
(Part Number 1827654-1 Feature)

| No. of Positions | Mount Type | Mount Angle | Part Number | Special Features |
|------------------|---------------|-------------|-------------|------------------------|
| 3 | Surface-Mount | Vertical | 1612898-1 | |
| 7 | Through Hole | Right-Angle | 1827654-1 | Retention Leg |
| 8 | Through Hole | Right-Angle | 1747785-1 | |
| 10 | Surface-Mount | Vertical | 2-1612962-3 | Nut Plate (both sides) |
| | Surface-Mount | Vertical | 1-1612962-3 | |
| | Surface-Mount | Vertical | 1717458-1 | One side nut plate |
| | Through Hole | Right-Angle | 1827501-1 | |

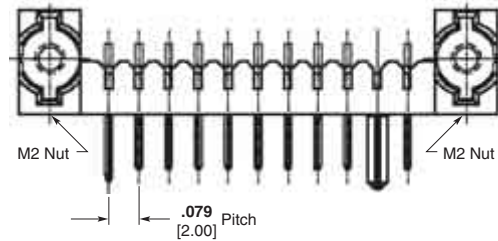

2 mm Plug Assembly with Nut Plates

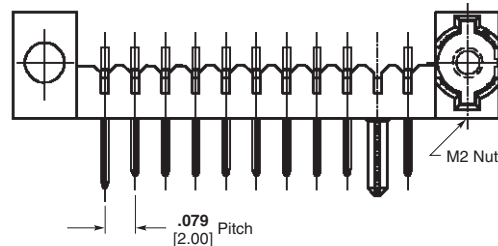

2 mm Plug Assembly with Nut Plate (One Side)

2.0 mm Pitch Receptacle Assemblies

Material and Finish

Housing — Black thermoplastic resin, UL 94V-0 rated

Contacts — High conductivity copper alloy, gold plating

| No. of Positions | Mount Type | Mount Angle | Part Number |
|------------------|---------------|-------------|-------------|
| 3 | Surface-Mount | Vertical | 1612901-1 |
| 7 | Surface-Mount | Vertical | 1827684-1 |
| | Through Hole | Vertical | 1827685-1 |
| 8 | Surface-Mount | Vertical | 1747786-1 |
| 10 | Through Hole | Vertical | 1612963-4 |
| | Surface-Mount | Vertical | 1612964-4 |

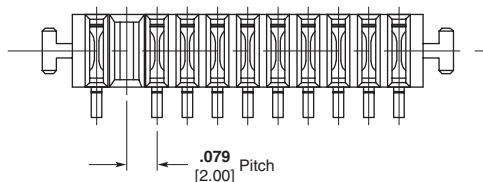
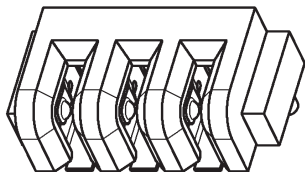

2.0 mm Receptacle Assembly,
Surface-Mount

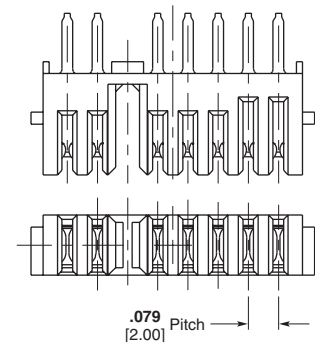

2.0 mm Receptacle Assembly,
Through Hole Mount

Note: All part numbers are RoHS compliant. Tin-lead versions are available upon request.

2.0 mm Pitch Multi-Directional Interconnection (MDI) Systems

6-Position Multi-Directional Headers

Material and Finish

Housing — Black liquid crystal polymer, UL 94V-0 rated

Contacts — Brass, plated .000030 [0.00076] min. gold on mating area, .00015 [0.0038] min. tin on solder tail, all over .000050 [0.00127] min. nickel

| Mount Type | Boardlocks | Part Number | Special Features |
|-----------------|------------|-------------|--------------------|
| Through Hole | With | 5146877-1 | Sequenced contacts |
| Retention Tails | Without | 5787252-1 | |
| Straight Solder | | 5787531-1 | Sequenced contacts |

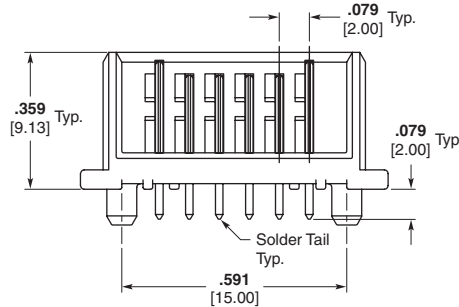

Part Number 5787531-1
Straight Solder Tails



Part Number 5787252-1
Below-the-Board Retention Tails



Part Number 5146877-1



6-Position Multi-Directional Receptacles

Material and Finish

Housing — Black liquid crystal polymer, UL 94V-0 rated

Contacts — Phosphor bronze, plated .000030 [0.00076] min. gold on mating area, .00015 [0.0038] min. tin on solder tail, all over .000050 [0.00127] min. nickel

| Mount Type | Boardlocks | Part Number |
|---------------|------------|-------------|
| Surface-Mount | With | 5787090-1 |
| Through Hole | Without | 5787253-1 |
| | | 5787526-1 |



Part Number 5787253-1
Through Hole Mount

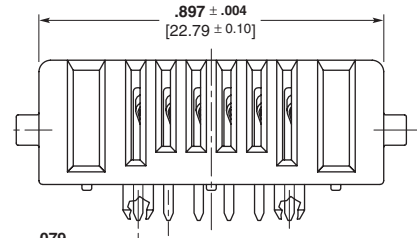

Part Number 5787526-1
Through Hole Mount



Part Number 5787090-1
Surface-Mount with Boardlocks



Note: All part numbers are RoHS compliant.

2.5 mm Pitch Battery Assemblies

2.5 mm Pitch Plug Assemblies

Material and Finish

Housing — Black thermoplastic resin, UL 94V-0 rated

Contacts — High conductivity copper alloy, gold plating

| No. of Positions | Mount Type | Mount Angle | Part Number | Special Features |
|------------------|--------------|----------------------|-------------|-----------------------|
| 4 | Through Hole | Right-Angle Offset | 6123987-1 | M2 Nut Plate |
| | Through Hole | Right-Angle Offset | 6123978-1 | |
| 5 | Through Hole | Right-Angle On Board | 6376042-2 | M2 Nut Plate |
| | Through Hole | Right-Angle On Board | 9-1612503-1 | |
| | Through Hole | Right-Angle Offset | 6318792-1 | |
| 6 | Through Hole | Vertical | 6473451-1 | |
| | Through Hole | Right-Angle Offset | 6318977-3 | M2 Nut Plate |
| 7 | Through Hole | Right-Angle On Board | 6318573-4 | |
| | Through Hole | Right-Angle On Board | 1747602-1 | M2 Nut Plate |
| 8 | Through Hole | Right-Angle On Board | 1717445-2 | |
| | Through Hole | Right-Angle On Board | 6123738-7 | |
| 10 | Through Hole | Right-Angle On Board | 1123822-7 | M2 Nut Plate |
| | Through Hole | Right-Angle On Board | 1123684-7 | One Side M2 Nut Plate |
| | Through Hole | Right-Angle Offset | 6473539-7 | M2 Nut Plate |



Part Number 6376042-2
Right-Angle On Board Assembly with Nut Plate



Part Number 6123978-1
Right-Angle Offset Assembly

2.5 mm Pitch Receptacle Assemblies

Material and Finish

Housing — Black thermoplastic resin, UL 94V-0 rated

Contacts — High conductivity copper alloy, gold plating

| No. of Positions | Mount Type | Mount Angle | Part Number |
|------------------|---------------|-------------|-------------|
| 4 | Through Hole | Right-Angle | 6123981-1 |
| 5 | Through Hole | Right-Angle | 6318430-2 |
| | Surface-Mount | Right-Angle | 1612504-1 |
| 6 | Surface-Mount | Vertical | 1123688-3 |
| 7 | Surface-Mount | Vertical | 1318574-4 |
| 8 | Through Hole | Vertical | 1717478-1 |
| | Through Hole | Right-Angle | 1717620-1 |
| 10 | Surface-Mount | Vertical | 1123688-7 |
| | Through Hole | Vertical | 1674231-1 |

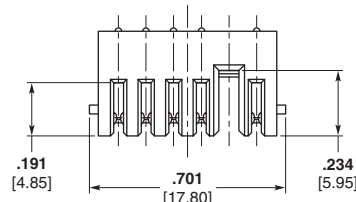

Part Number 6318430-2
Right-Angle Through Hole Mount



Part Number 1318574-4
Vertical Surface-Mount

Note: All part numbers are RoHS compliant.

5.0 mm Pitch Battery Plug Assemblies

5.0 mm Pitch Right-Hand Key Plug Assemblies



Material and Finish

Housing — Polyphthalamide, UL 94V-0 rated, black
Contacts — Brass, plated .000100 [0.00254] min. tin on solder tail over .000075 [0.00190] min. nickel overall

| Voltage | Mount Type | Mount Angle | Part Number |
|---------|------------------|-------------|-------------|
| 12.0 | Retentive Solder | Right-Angle | 5787424-1 |
| | Straight Solder | Right-Angle | 5787422-1 |
| | Straight Solder | Vertical | 5787430-1 |
| 10.8 | Retentive Solder | Vertical | 5787421-1 |
| | Straight Solder | Vertical | 5787419-1 |
| 7.2 | Retentive Solder | Right-Angle | 5787141-1 |
| | Straight Solder | Vertical | 5787334-1 |
| | Straight Solder | Right-Angle | 5787142-1 |

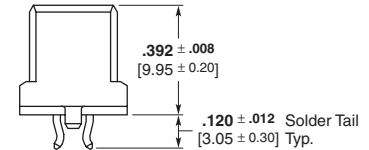
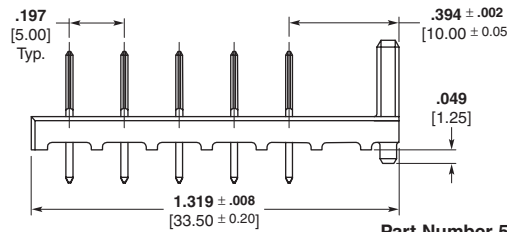

Part Number 5787421-1
Vertical Assembly with Retentive Tails

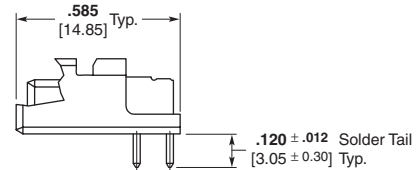
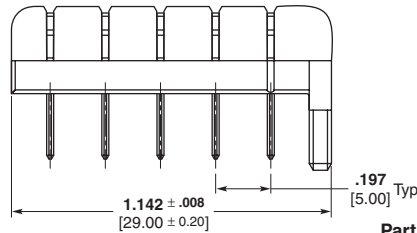

Part Number 5787142-1
Right-Angle Assembly with Straight Tails

5.0 mm Pitch Left-Hand Key Plug Assemblies

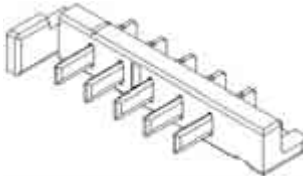

Material and Finish

Housing — Polyphthalamide, UL 94V-0 rated, black
Contacts — Brass, plated .000100 [0.00254] min. tin on solder tail over .000075 [0.00190] min. nickel overall

| Voltage | Mount Type | Mount Angle | Part Number | Special Features |
|---------|------------------|-------------|-------------|------------------|
| 12.0 | Straight Solder | Right-Angle | 5787428-1 | Mounting Holes |
| 10.8 | Retentive Solder | Right-Angle | 5787418-1 | |
| | Straight Solder | Right-Angle | 5787246-1 | |

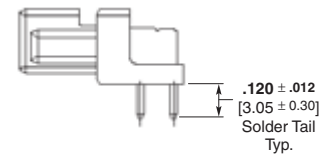
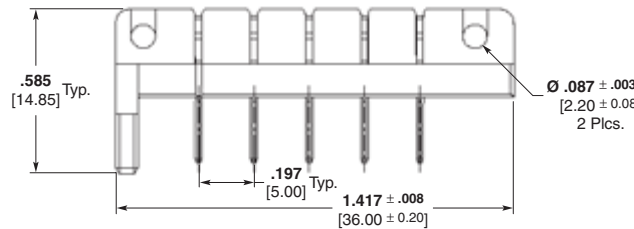

Part Number 5787428-1
Right-Angle Assembly with Mounting Holes

5.0 mm Pitch Keyless Plug Assemblies

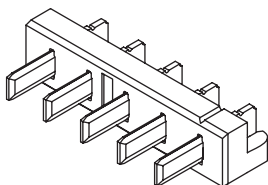

Material and Finish

Housing — Polyphthalamide, UL 94V-0 rated, black
Contacts — Brass, plated .000100 [0.00254] min. tin on solder tail over .000075 [0.00190] min. nickel overall

| Voltage | Mount Type | Mount Angle | Part Number | Special Features |
|---------|------------------|-------------|-------------|--------------------|
| N/A | Straight Solder | Right-Angle | 5787441-1 | |
| | Retentive Solder | Right-Angle | 5787443-1 | |
| | Straight Solder | Right-Angle | 5796078-1 | Sequenced Contacts |
| | Retentive Solder | Vertical | 5787446-1 | |
| | Straight Solder | Vertical | 5787444-1 | |

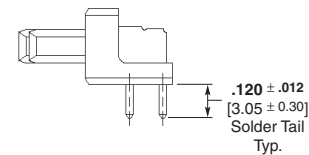
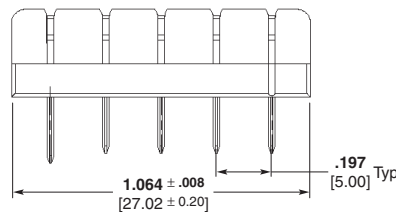

Part Number 5796078-1
Right-Angle Assembly with Straight Tails & Sequenced Contacts

Note: All part numbers are RoHS compliant.

5.0 mm Pitch Battery Receptacle Assemblies

5.0 mm Pitch Right-Hand Key Receptacle Assemblies

Material and Finish

Housing — Black polycarbonate, UL 94V-0 rated

Contacts — Copper alloy, plated .000075 [0.00190] min. nickel

| Voltage | Mount Type | Part Number |
|---------|---------------|-------------|
| 12.0 | Surface-Mount | 787439-1 |
| | Weld Tabs | 787615-1 |
| 10.8 | Weld Tabs | 787614-1 |

Note: All receptacles include a dovetail locator.

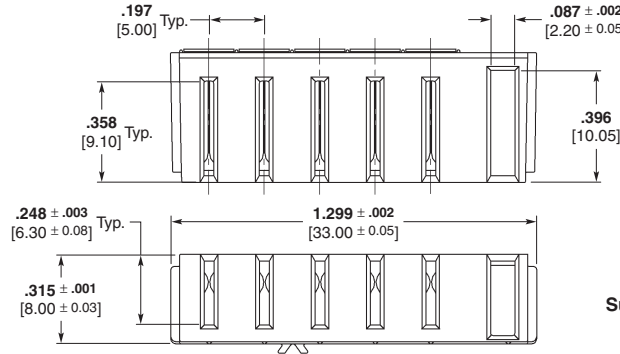

Part Number 787439-1
Surface-Mount Receptacle

5.0 mm Pitch Left-Hand Key Receptacle Assemblies

Material and Finish

Housing — Black polycarbonate, UL 94V-0 rated

Contacts — Copper alloy, plated .000075 [0.00190] min. nickel

| Voltage | Mount Type | Part Number |
|---------|---------------|-------------|
| 7.2 | Solder Tail | 5787590-1 |
| | Surface-Mount | 787328-1 |
| | Weld Tab | 787613-1 |

Note: All receptacles include a dovetail locator.

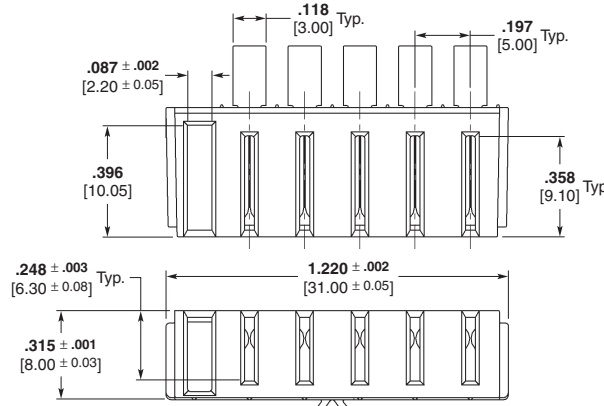

Part Number 787613-1
Weld Tab Receptacle

5.0 mm Pitch Keyless Receptacle Assemblies

Material and Finish

Housing — Black polycarbonate, UL 94V-0 rated

Contacts — Copper alloy, plated .000075 [0.00190] min. nickel

| Voltage | Mount Type | Part Number |
|---------|---------------|-------------|
| N/A | Solder Tail | 5787802-1 |
| | Surface-Mount | 146845-1 |

Note: All receptacles include a dovetail locator.



Part Number 5787802-1
Solder Tail Receptacle

Note: All part numbers are RoHS compliant.

Coin Cell Battery Holders

Horizontal Mount Battery Holders

Material and Finish

Housing — Black thermoplastic resin, UL 94V-0 rated

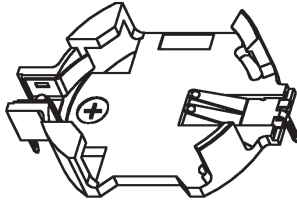

| Mount Type | Part Number | Special Features |
|---------------|-------------|-----------------------------------|
| Surface-Mount | 796136-1 | |
| Through Hole | 1734178-1 | Flexible housing for easy removal |
| | 120591-1 | |



Part Number 120591-1
Through Hole Mount

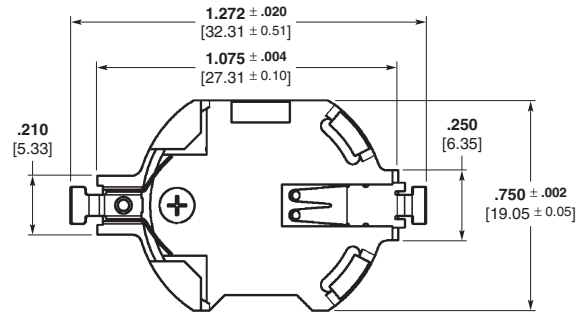

Part Number 796136-1
Surface-Mount

Vertical Mount Battery Holders

Material and Finish

Housing — Black thermoplastic resin, UL 94V-0 rated

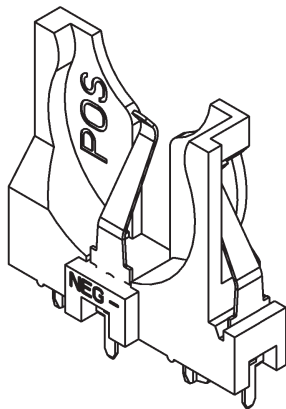

| Mount Type | Part Number | Special Features |
|--------------|-------------|------------------|
| Through Hole | 6339488-1 | |
| | 1775485-1 | Low Profile |

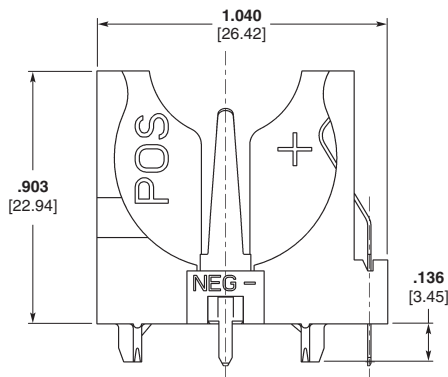

Part Number 6339488-1

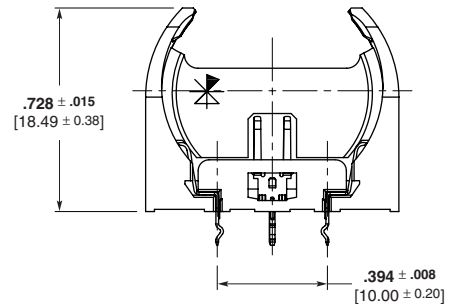

Part Number 1775485-1
Low Profile

Note: All part numbers are RoHS compliant.

DC Power Jacks

Product Facts

- Low Profile Design
- Accepts industry standard DC power plugs
- Available with:
 - Solder tabs
 - Through-hole solder tails
 - SMT leads
- Available to accept these plug sizes:
 - 0.65 mm
 - 1.0 mm
 - 1.3 mm
 - 1.47 mm
 - 1.87 mm
 - 2.0 mm
 - 2.35 mm
 - 2.5 mm
- Ideal for portable electric devices



Surface-Mount Power Jacks

Pin Diameters — 0.65 mm and 1.3 mm

Part Number 1775638-1

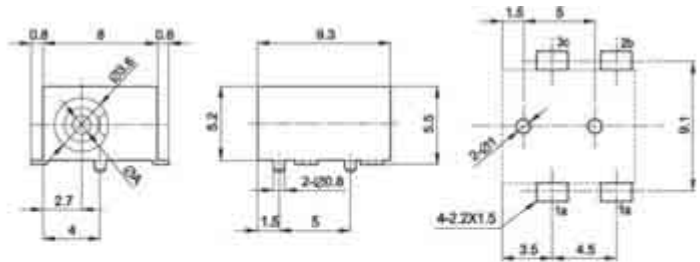

Bottom View

| | |
|------------------------|---------|
| CENTER PIN DIAMETER: A | 1.3 DIA |
| SCHMATIC | |

Part Number 1775639-1

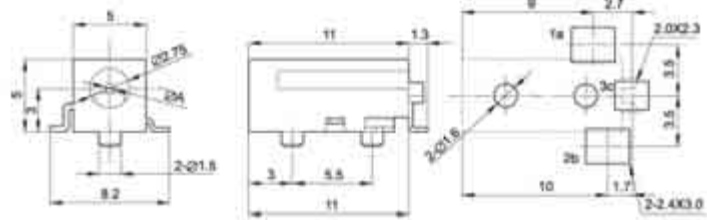

Bottom View

| | |
|------------------------|----------|
| CENTER PIN DIAMETER: A | 0.65 DIA |
| SCHMATIC | |

Vertical DC Jack

Part Number 1470390-1

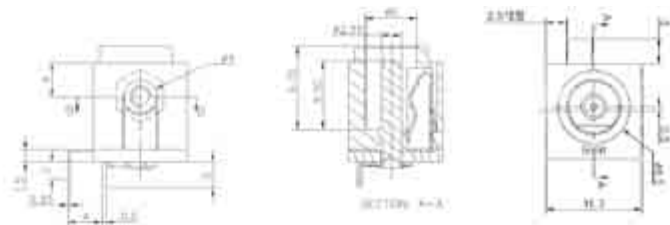

Note: All part numbers are RoHS compliant.

DC Power Jacks (Continued)

Right-Angle DC Jacks Miniature Jacks

For specific part numbers, contact Tyco Electronics

| Center Dia. | Tail Length | Part Number |
|-------------|-------------|-------------|
| 1.30 | 3.00 | 1775529-1 |
| | 1.50 | 1775529-2 |
| 1.00 | 3.00 | 1-1775529-1 |
| | 1.50 | 1-1775529-2 |



| CENTER PIN DIAMETER/A | 1.3 DIA | | 1.0 DIA | | 1.3 DIA | |
|-----------------------|---------|-------|---------|-------|---------|-------|
| B LENGTH | 3.0mm | 1.5mm | 3.0mm | 1.5mm | 3.0mm | 1.5mm |
| SCHEMATIC | | | | | | |

Shielded Jack

| Dia. A | N.W. (q) | Part Number |
|--------|----------|-------------|
| 2.0 | 1.8 | 1734894-1 |
| 2.5 | 2.0 | 1734894-2 |

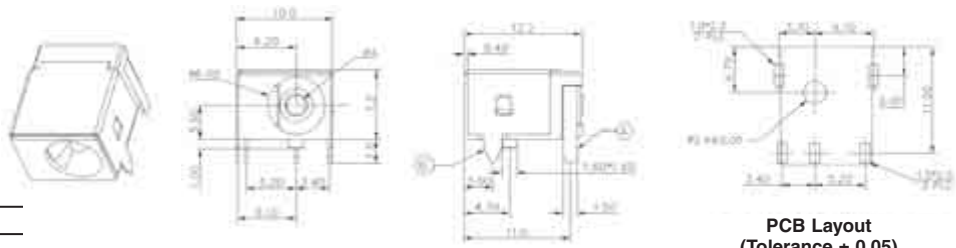

PCB Layout (Tolerance ± 0.05)

Standard Jacks

| Center Diameter | Part Number |
|-----------------|-------------|
| 2.00 | 1775069-1 |
| 2.35 | 1775069-2 |
| 2.50 | 1775069-3 |



| CENTER PIN DIAMETER/A | 1.35 DIA | 1.47 DIA | 1.7 DIA | 1.87 DIA | 2.0 DIA | 2.2 DIA | 2.35 DIA | 2.5 DIA |
|-----------------------|----------|----------|---------|----------|---------|---------|----------|---------|
| SCHEMATIC | | | | | | | | |

Standard Jack — Recessed Flange

For specific part numbers, contact Tyco Electronics

| Center Diameter | Part Number |
|-----------------|-------------|
| 1.47 | 1775637-1 |
| 1.87 | 1775637-2 |
| 2.00 | 1775637-3 |
| 2.35 | 1775637-4 |
| 2.45 | 1775637-5 |

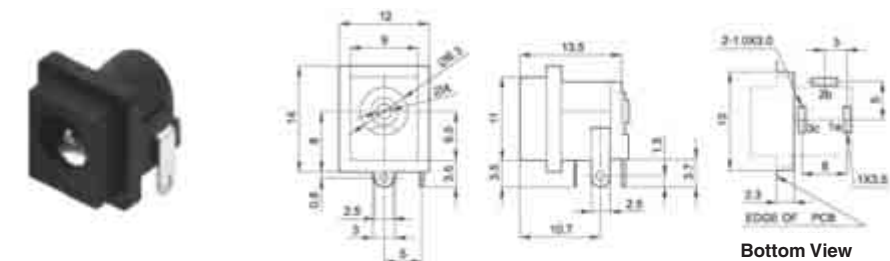

Bottom View

| CENTER PIN DIAMETER/A | 1.47 DIA | 1.87 DIA | 2.0 DIA | 2.35 DIA | 2.45 DIA |
|-----------------------|----------|----------|---------|----------|----------|
| SCHEMATIC | | | | | |

Note: All part numbers are RoHS compliant.

Mouser Electronics

Authorized Distributor

Click to View Pricing, Inventory, Delivery & Lifecycle Information:

[TE Connectivity:](#)

[1717478-1](#)