

## Overview

The R46 series is constructed of metallized polypropylene film encapsulated with self-extinguishing resin in a box of material that meets the requirements of UL 94 V-0.

## Applications

For worldwide use in electromagnetic interference (EMI) suppression in across-the-line applications that require X2 safety classification. Intended for use in situations in which capacitor failure would not result in exposure to electric shock. Not for use in "series with mains" type applications.

## Benefits

- Approvals: ENEC, UL, cUL, CQC
- X2 CLASS (IEC 60384-14)
- Rated voltage: 310 VAC 50/60 Hz
- Capacitance range: 0.01 – 10  $\mu$ F
- Lead spacing: 10.0 – 37.5 mm
- Capacitance tolerance:  $\pm$ 20%,  $\pm$ 10%
- Climatic category 40/110/56, IEC 60068-1
- Tape & Reel in accordance with IEC 60286-2
- RoHS compliant and lead-free terminations
- Operating temperature range of  $-40^{\circ}\text{C}$  to  $+110^{\circ}\text{C}$
- 100% screening factory test at 2,200 VDC/1,500 VAC
- Self healing properties

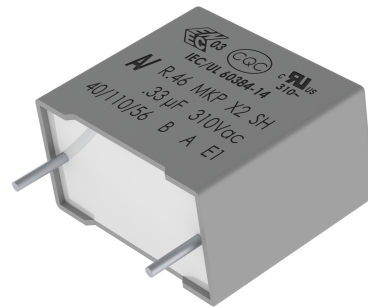

## Part Number System

R46	3	N	3150	00	01	M
Series	Rated Voltage (VAC)	Lead Spacing (mm)	Capacitance Code (pF)	Packaging	Internal Use	Capacitance Tolerance
X2, Metallized Polypropylene	3 = 310	F = 10.0 I = 15.0 N = 22.5 R = 27.5 W = 37.5	The last three digits represent significant figures. The first digit specifies number of zeros to be added.	See Ordering Options Table	01 02 L2 M1 M2 N0 N1 N2	K = $\pm$ 10% M = $\pm$ 20%

## Ordering Options Table

Lead Spacing Nominal (mm)	Type of Leads and Packaging	Lead Length (mm)	Lead and Packaging Code
10 15 22.5	<b>Standard Lead and Packaging Options</b>		
	Bulk (Bag) – Short Leads	4 +2/-0	00
	Ammo Pack	H <sub>0</sub> = 18.5 ±0.5	DQ
	<b>Other Lead and Packaging Options</b>		
	Tape & Reel (Large Reel)	H <sub>0</sub> = 18.5 ±0.5	CK
	Bulk (Bag) – Short Leads	2.7 +0.5/-0	JA
	Bulk (Bag) – Short Leads	3.5 +0.5/-0	JB
	Bulk (Bag) – Short Leads	4.0 +0.5/-0	JE
	Bulk (Bag) – Short Leads	3.2 +0.3/-0.2	JH
	Bulk (Bag) – Long Leads	18 ±1	JM
	Bulk (Bag) – Long Leads	30 +5/-0	40
	Bulk (Bag) – Long Leads	25 +2/-1	50
	Bulk (Bag) – Insulated Rigid Leads	30 +5/-0 (sp 8 ±2)	51
	Bulk (Bag) – Insulated Flexible Leads	150 ±5 (sp 8 ±2)	52
27.5	<b>Standard Lead and Packaging Options</b>		
	Bulk (Bag) – Short Leads	4 +2/-0	00
	Tape & Reel (Large Reel)	H <sub>0</sub> = 18.5 ±0.5	CK
	<b>Other Lead and Packaging Options</b>		
	Bulk (Tray) – Short Leads	2.7 +0.5/-0	JA
	Bulk (Tray) – Short Leads	3.5 +0.5/-0	JB
	Bulk (Tray) – Short Leads	4.0 +0.5/-0	JE
	Bulk (Tray) – Short Leads	3.2 +0.3/-0.2	JH
	Bulk (Tray) – Long Leads	18 ±1	JM
	Bulk (Tray) – Long Leads	30 +5/-0	40
	Bulk (Tray) – Long Leads	25 +2/-1	50
	Bulk (Bag) – Insulated Rigid Leads	30 +5/-0 (sp 8 ±2)	51
	Bulk (Bag) – Insulated Flexible Leads	150 ±5 (sp 8 ±2)	52
	37.5	<b>Standard Lead and Packaging Options</b>	
Bulk (Tray) – Short Leads		4 +2/-0	00
<b>Other Lead and Packaging Options</b>			
Bulk (Tray) – Short Leads		2.7 +0.5/-0	JA
Bulk (Tray) – Short Leads		3.5 +0.5/-0	JB
Bulk (Tray) – Short Leads		4.0 +0.5/-0	JE
Bulk (Tray) – Short Leads		3.2 +0.3/-0.2	JH
Bulk (Tray) – Long Leads		18 ±1	JM
Bulk (Tray) – Long Leads		30 +5/-0	40
Bulk (Tray) – Long Leads		25 +2/-1	50
Bulk (Bag) – Insulated Rigid Leads		30 +5/-0 (sp 8 ±2)	51
Bulk (Bag) – Insulated Flexible Leads		150 ±5 (sp 8 ±2)	52

## Dimensions – Millimeters

### Loose

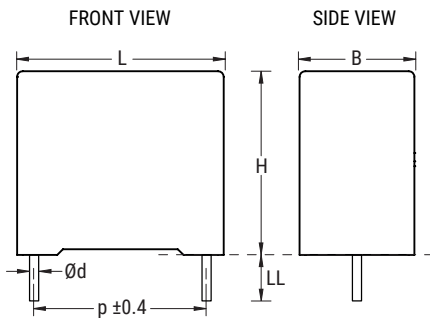

### Insulated Rigid Leads

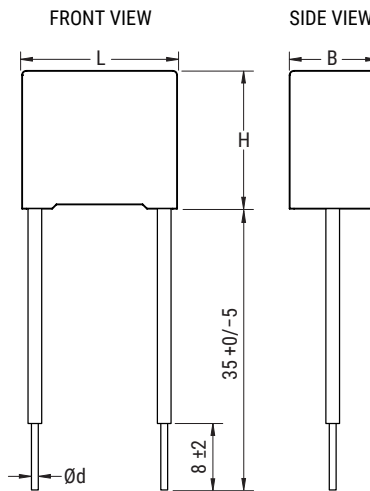

### Insulated Flexible Leads 0.5 mm<sup>2</sup>

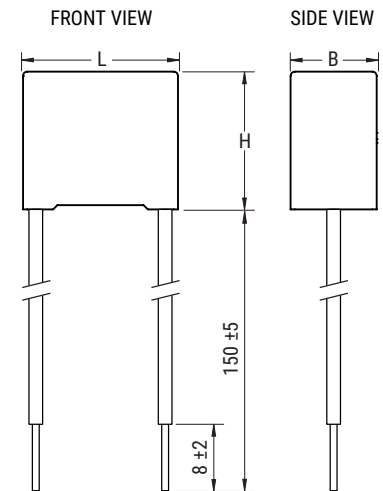

p		B		H		L		d	
Nominal	Tolerance	Nominal	Tolerance	Nominal	Tolerance	Nominal	Tolerance	Nominal	Tolerance
10.0	±0.4	4.0	+0.2	9.0	+0.1	13.0	+0.2	0.6	±0.05
10.0	±0.4	5.0	+0.2	11.0	+0.1	13.0	+0.2	0.6	±0.05
10.0	±0.4	6.0	+0.2	12.0	+0.1	13.0	+0.2	0.6	±0.05
15.0	±0.4	5.0	+0.2	11.0	+0.1	18.0	+0.3	0.6	±0.05
15.0	±0.4	6.0	+0.2	12.0	+0.1	18.0	+0.3	0.6	±0.05
15.0	±0.4	6.0	+0.2	17.5	+0.1	18.0	+0.3	0.6	±0.05
15.0	±0.4	7.5	+0.2	13.5	+0.1	18.0	+0.5	0.6	±0.05
15.0	±0.4	7.5	+0.2	18.5	+0.1	18.0	+0.5	0.8	±0.05
15.0	±0.4	8.5	+0.2	14.5	+0.1	18.0	+0.5	0.6	±0.05
15.0	±0.4	9.0	+0.2	12.5	+0.1	18.0	+0.5	0.6	±0.05
15.0	±0.4	10.0	+0.2	16.0	+0.1	18.0	+0.5	0.8	±0.05
15.0	±0.4	11.0	+0.2	19.0	+0.1	18.0	+0.5	0.8	±0.05
15.0	±0.4	13.0	+0.2	12.0	+0.1	18.0	+0.5	0.8	±0.05
22.5	±0.4	6.0	+0.2	15.0	+0.1	26.5	+0.3	0.8	±0.05
22.5	±0.4	7.0	+0.2	16.0	+0.1	26.5	+0.3	0.8	±0.05
22.5	±0.4	10.0	+0.2	18.5	+0.1	26.5	+0.3	0.8	±0.05
22.5	±0.4	11.0	+0.2	20.0	+0.1	26.5	+0.3	0.8	±0.05
22.5	±0.4	13.0	+0.2	22.0	+0.1	26.5	+0.3	0.8	±0.05
27.5	±0.4	9.0	+0.2	17.0	+0.1	32.0	+0.3	0.8	±0.05
27.5	±0.4	11.0	+0.2	20.0	+0.1	32.0	+0.3	0.8	±0.05
27.5	±0.4	13.0	+0.2	22.0	+0.1	32.0	+0.3	0.8	±0.05
27.5	±0.4	13.0	+0.2	25.0	+0.1	32.0	+0.3	0.8	±0.05
27.5	±0.4	14.0	+0.2	28.0	+0.1	32.0	+0.3	0.8	±0.05
27.5	±0.4	18.0	+0.2	33.0	+0.1	32.0	+0.3	0.8	±0.05
27.5	±0.4	22.0	+0.2	37.0	+0.1	32.0	+0.3	0.8	±0.05

Note: See Ordering Options Table for lead length (LL/H<sub>0</sub>) options.

## Dimensions – Millimeters cont.

### Loose

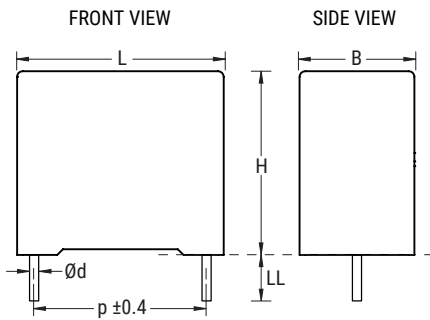

### Insulated Rigid Leads

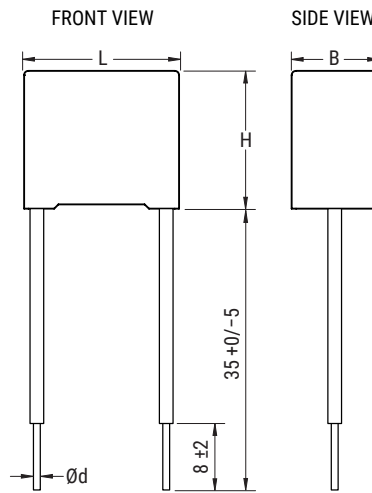

### Insulated Flexible Leads 0.5 mm<sup>2</sup>

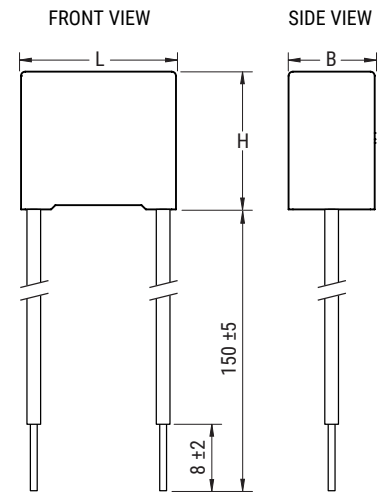

p		B		H		L		d	
Nominal	Tolerance	Nominal	Tolerance	Nominal	Tolerance	Nominal	Tolerance	Nominal	Tolerance
37.5	±0.4	11.0	+0.3	22.0	+0.1	41.5	+0.3	1.0	±0.05
37.5	±0.4	13.0	+0.3	24.0	+0.1	41.5	+0.3	1.0	±0.05
37.5	±0.4	16.0	+0.3	28.5	+0.1	41.5	+0.3	1.0	±0.05
37.5	±0.4	19.0	+0.3	32.0	+0.1	41.5	+0.3	1.0	±0.05
37.5	±0.4	20.0	+0.3	40.0	+0.1	41.5	+0.3	1.0	±0.05
37.5	±0.4	24.0	+0.3	44.0	+0.1	41.5	+0.3	1.0	±0.05
37.5	±0.4	30.0	+0.3	45.0	+0.1	41.5	+0.3	1.0	±0.05

**Note: See Ordering Options Table for lead length (LL/H<sub>0</sub>) options.**

## Performance Characteristics

Dielectric	Polypropylene film			
Plates	Metal layer deposited by evaporation under vacuum			
Winding	Non-inductive type			
Leads	Tinned wire			
Protection	Plastic case, thermosetting resin filled. Box material is solvent resistant and flame retardant according to UL94.			
Related Documents	IEC 60384-14, EN 60384-14			
Rated Voltage $V_R$	310 VAC (50/60 Hz), 630 VDC			
Capacitance Range	0.010 – 10 $\mu$ F			
Capacitance Values	E6 series (IEC 60063) measured at 1 kHz and +20 $\pm$ 1°C			
Capacitance Tolerance	$\pm$ 10%, $\pm$ 20%			
Temperature Range	-40°C to +110°C			
Climatic Category	40/110/56 IEC 60068-1			
Storage Conditions	Storage time: $\leq$ 24 months from the date marked on the label package			
	Average relative humidity per year $\leq$ 70%			
	RH $\leq$ 85% for 30 days randomly distributed throughout the year			
	Dew is absent			
	Temperature: -40 to 80°C (see "Maximum Humidity in Storage Conditions" graph below)			
Approvals	ENEC, UL, cUL, CQC			
Dissipation Factor ( $\tan\delta$ )	$\leq$ 0.1% (0.06%*) at 1 kHz, +25°C $\pm$ 5°C (* typical value)			
Test Voltage Between Terminals	The 100% screening factory test is carried out at 2,200 VDC/1,500 VAC. The voltage level is selected to meet the requirements in applicable equipment standards. All electrical characteristics are checked after the test. This test cannot be repeated, as there is a risk of damaging the capacitor. KEMET is not liable in such cases for any failures.			
Insulation Resistance	Measured at +25°C $\pm$ 5°C, according to IEC 60384-2			
	Minimum Values Between Terminals			
	Voltage Charge	Voltage Charge Time	C $\leq$ 0.33 $\mu$ F	C > 0.33 $\mu$ F
100 VDC	1 minute	$\geq$ 1 $\cdot$ 10 <sup>5</sup> M $\Omega$ ( $\geq$ 5 $\cdot$ 10 <sup>5</sup> M $\Omega$ )*	$\geq$ 30,000 M $\Omega$ $\cdot$ $\mu$ F ( $\geq$ 150,000 M $\Omega$ $\cdot$ $\mu$ F)*	
In DC Applications	Recommended voltage $\leq$ 630 VDC			

\* Typical value

## Performance Characteristics cont.

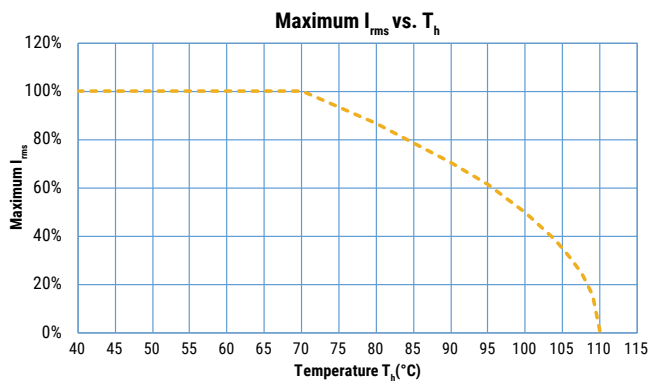
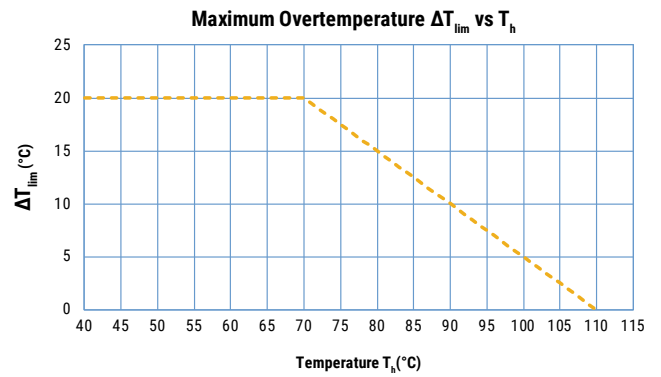
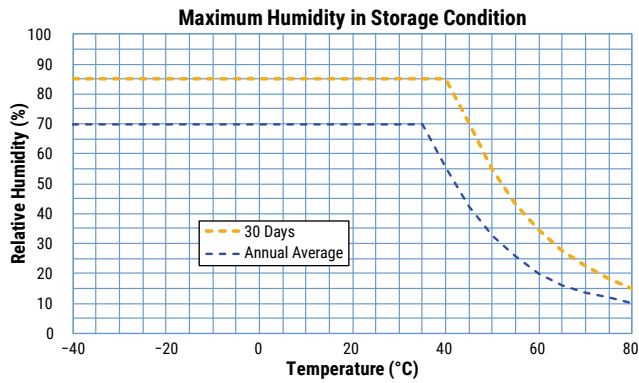

$T_h$  is the maximum ambient temperature surrounding the capacitor or hottest contact point (e.g. tracks), whichever is higher, in the worst operation conditions in °C.

## Impedance Graph

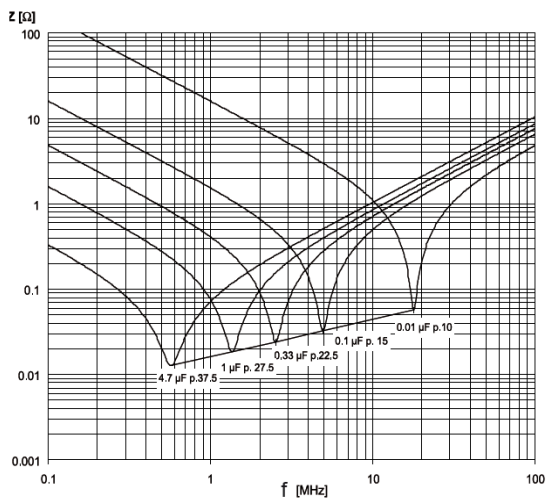

## Maximum Voltage ( $V_{rms}$ ) Versus Frequency (Sinusoidal Waveform/ $Th \leq 70^\circ C$ )

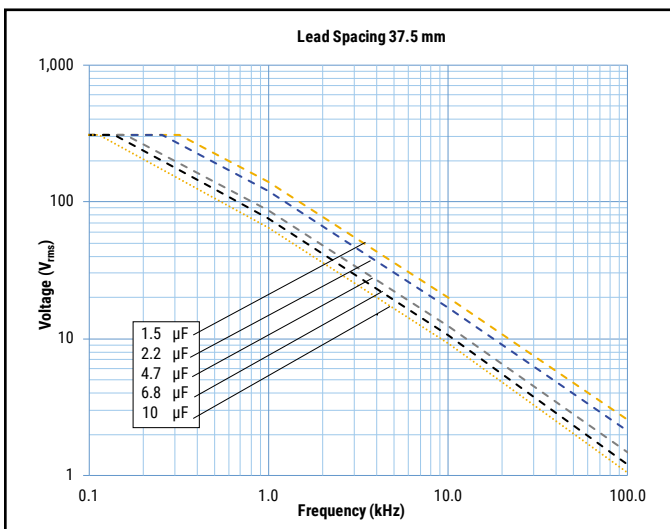
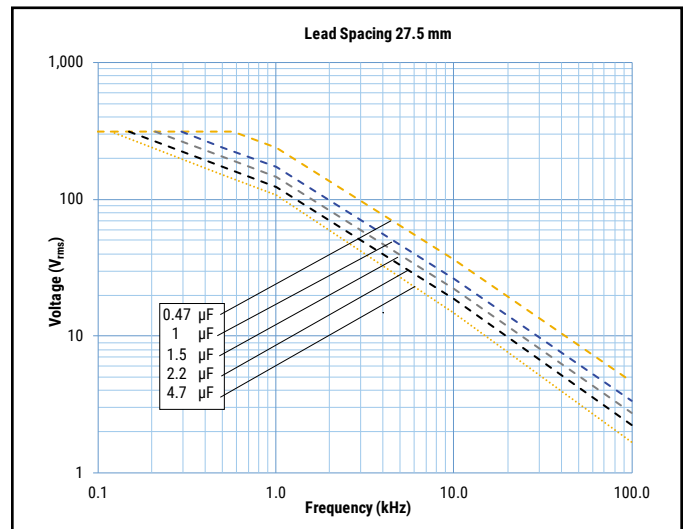
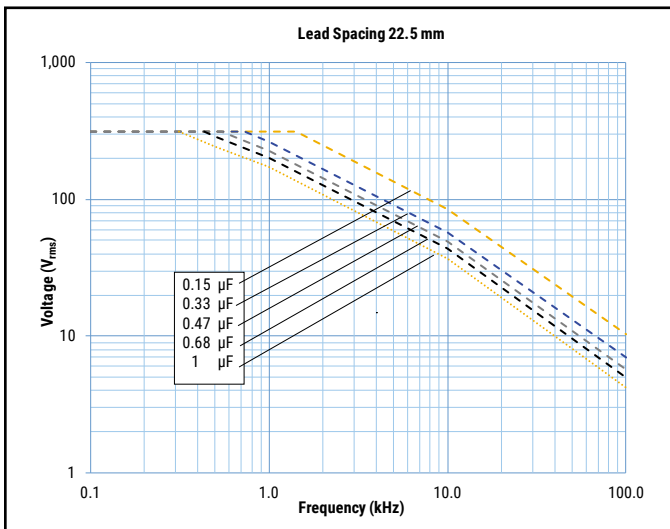
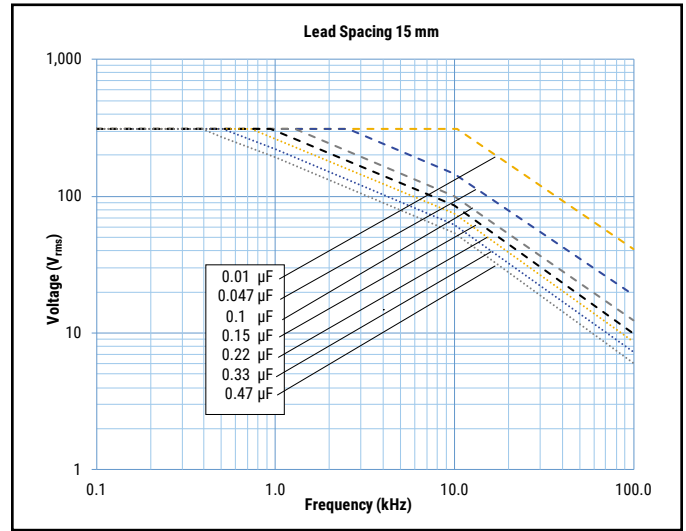
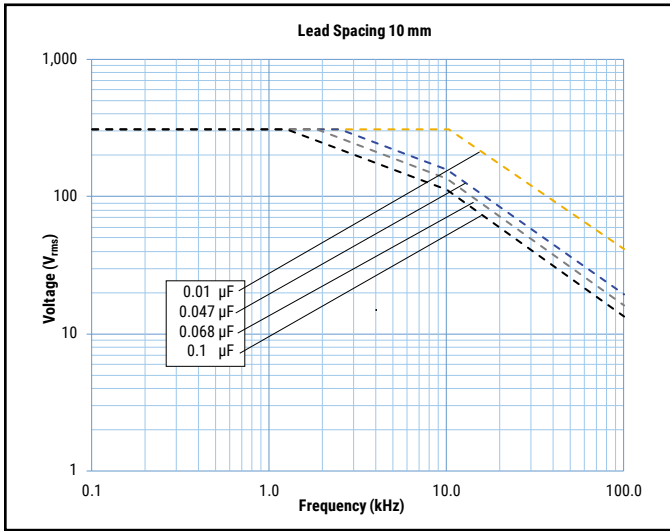

## Maximum Current ( $I_{rms}$ ) Versus Frequency (Sinusoidal Waveform/ $T_h \leq 70^\circ\text{C}$ )

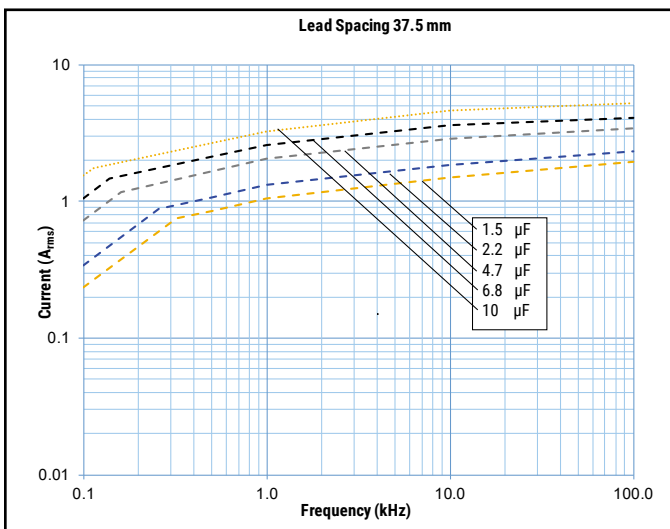
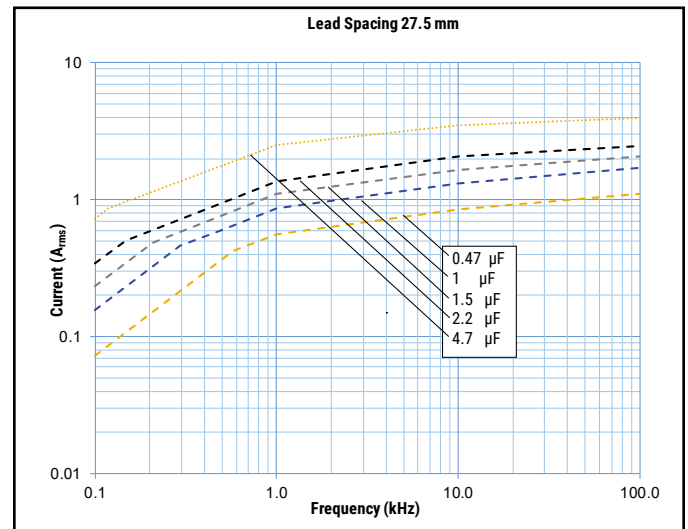
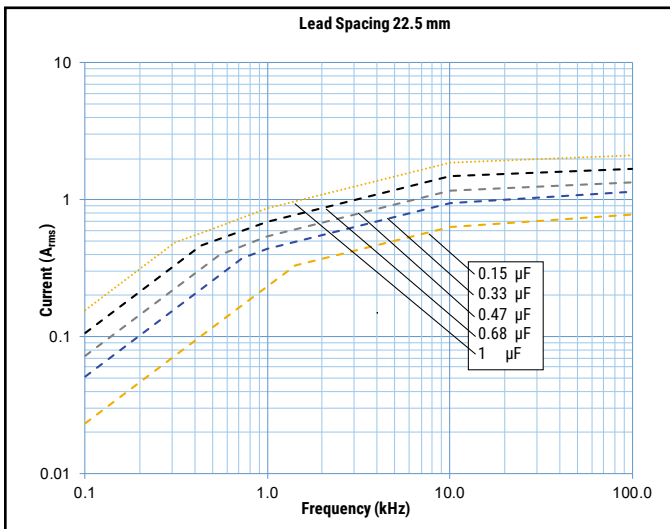
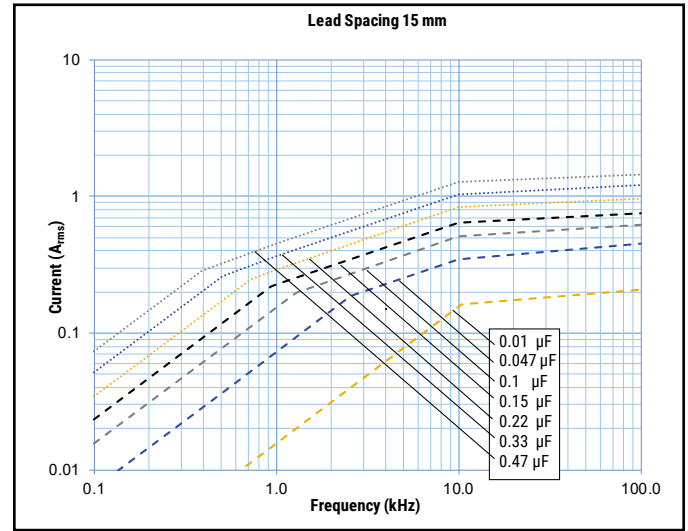
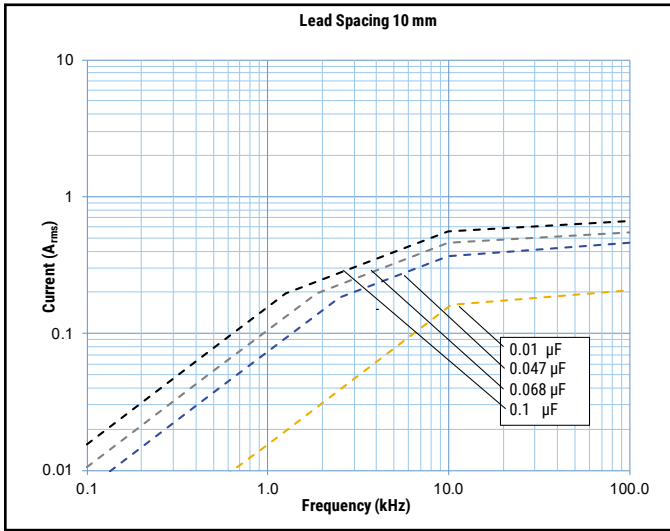





## Environmental Test Data

Test	IEC Publication	Procedure
Endurance	EN/IEC 60384-14	1.25 x V <sub>R</sub> VAC 50 Hz, once every hour increase to 1,000 VAC for 0.1 second, 1,000 hours at upper rated temperature
Vibration	IEC 60068-2-6 Test Fc	3 directions at 2 hours each 10 – 55 Hz at 0.75 mm or 98 m/s <sup>2</sup>
Bump	IEC 60068-2-29 Test Eb	1,000 bumps at 390 m/s <sup>2</sup>
Change of Temperature	IEC 60068-2-14 Test Na	Upper and lower rated temperature 5 cycles
Active Flammability	IEC 60384-14	V <sub>R</sub> + 20 surge pulses at 2.5 kV (pulse every 5 seconds)
Passive Flammability	IEC 60384-14	IEC 60384-1, IEC 60695-11-5 Needle flame test
Damp Heat Steady State	IEC 60068-2-78 Test Cab	+40°C and 93% RH, 56 days

## Approvals

Mark	Specification	File Number
	EN/IEC 60384-14	V4413
	UL 60384-14 and CAN/CSA E60384-14 (310 VAC)	E97797
	IEC 60384-14	CQC08001026549 CQC11001060118 CQC13001087757 CQC14001116028 CQC13001101266 CQC14001116000

## Environmental Compliance

All KEMET EMI capacitors are RoHS compliant.



**Table 1 – Ratings & Part Number Reference**

Capacitance Value (µF)	Dimensions in mm			Lead Spacing (p)	dV/dt (V/µs)	New KEMET Part Number	Legacy Part Number
	B	H	L				
0.010	4.0	9.0	13.0	10.0	500	463F2100(1)N0(2)	R463F2100(1)N0(2)
0.015	4.0	9.0	13.0	10.0	500	463F2150(1)N0(2)	R463F2150(1)N0(2)
0.022	4.0	9.0	13.0	10.0	500	463F2220(1)N0(2)	R463F2220(1)N0(2)
0.033	5.0	11.0	13.0	10.0	500	463F2330(1)M1(2)	R463F2330(1)M1(2)
0.047	5.0	11.0	13.0	10.0	500	463F2470(1)N0(2)	R463F2470(1)N0(2)
0.068	6.0	12.0	13.0	10.0	500	463F2680(1)M1(2)	R463F2680(1)M1(2)
0.10	6.0	12.0	13.0	10.0	500	463F3100(1)M1(3)	R463F3100(1)M1(3)
0.010	5.0	11.0	18.0	15.0	400	463I2100(1)01(2)	R463I2100(1)01(2)
0.015	5.0	11.0	18.0	15.0	400	463I2150(1)01(2)	R463I2150(1)01(2)
0.022	5.0	11.0	18.0	15.0	400	463I2220(1)01(2)	R463I2220(1)01(2)
0.033	5.0	11.0	18.0	15.0	400	463I2330(1)01(2)	R463I2330(1)01(2)
0.047	5.0	11.0	18.0	15.0	400	463I2470(1)01(2)	R463I2470(1)01(2)
0.068	5.0	11.0	18.0	15.0	400	463I2680(1)01(2)	R463I2680(1)01(2)
0.10	5.0	11.0	18.0	15.0	400	463I3100(1)M1(2)	R463I3100(1)M1(2)
0.15	6.0	12.0	18.0	15.0	400	463I3150(1)M2(2)	R463I3150(1)M2(2)
0.15	9.0	12.5	18.0	15.0	400	463I3150(1)L2(2)	R463I3150(1)L2(2)
0.22	7.5	13.5	18.0	15.0	400	463I3220(1)M2(2)	R463I3220(1)M2(2)
0.22	9.0	12.5	18.0	15.0	400	463I3220(1)L2(2)	R463I3220(1)L2(2)
0.22	6.0	17.5	18.0	15.0	400	463I3220(1)02(2)	R463I3220(1)02(2)
0.33	8.5	14.5	18.0	15.0	400	463I3330(1)N0(2)	R463I3330(1)N0(2)
0.33	10.0	16.0	18.0	15.0	400	463I3330(1)M1(2)	R463I3330(1)M1(2)
0.33	7.5	18.5	18.0	15.0	400	463I3330(1)02(2)	R463I3330(1)02(2)
0.33	13.0	12.0	18.0	15.0	400	463I3330(1)01(2)	R463I3330(1)01(2)
0.47	10.0	16.0	18.0	15.0	400	463I3470(1)N0(3)	R463I3470(1)N0(3)
0.47	11.0	19.0	18.0	15.0	400	463I3470(1)M1(2)	R463I3470(1)M1(2)
0.56	11.0	19.0	18.0	15.0	400	463I3560(1)N0(2)	R463I3560(1)N0(2)
0.60	11.0	19.0	18.0	15.0	400	463I3600(1)N0(2)	R463I3600(1)N0(2)
0.15	6.0	15.0	26.5	22.5	200	463N3150(1)01(2)	R463N3150(1)01(2)
0.22	6.0	15.0	26.5	22.5	200	463N3220(1)M1(2)	R463N3220(1)M1(2)
0.33	6.0	15.0	26.5	22.5	200	463N3330(1)N0(2)	R463N3330(1)N0(2)
0.47	7.0	16.0	26.5	22.5	200	463N3470(1)N0(2)	R463N3470(1)N0(2)
0.68	10.0	18.5	26.5	22.5	200	463N3680(1)M2(2)	R463N3680(1)M2(2)
1.0	10.0	18.5	26.5	22.5	200	463N4100(1)N2(3)	R463N4100(1)N2(3)
1.0	11.0	20.0	26.5	22.5	200	463N4100(1)N1(2)	R463N4100(1)N1(2)
1.5	13.0	22.0	26.5	22.5	200	463N4150(1)N1(2)	R463N4150(1)N1(2)
0.47	9.0	17.0	32.0	27.5	150	463R3470(1)01(2)	R463R3470(1)01(2)
0.68	9.0	17.0	32.0	27.5	150	463R3680(1)M1(2)	R463R3680(1)M1(2)
1.0	11.0	20.0	32.0	27.5	150	463R4100(1)M1(2)	R463R4100(1)M1(2)
1.5	13.0	22.0	32.0	27.5	150	463R4150(1)M1(2)	R463R4150(1)M1(2)
2.2	13.0	25.0	32.0	27.5	150	463R4220(1)M2(2)	R463R4220(1)M2(2)
2.2	14.0	28.0	32.0	27.5	150	463R4220(1)M1(2)	R463R4220(1)M1(2)
3.3	18.0	33.0	32.0	27.5	150	463R4330(1)M2(2)	R463R4330(1)M2(2)
4.7	18.0	33.0	32.0	27.5	150	463R4470(1)M2(2)	R463R4470(1)M2(2)
4.7	22.0	37.0	32.0	27.5	150	463R4470(1)M1(2)	R463R4470(1)M1(2)
1.5	11.0	22.0	41.5	37.5	100	463W4150(1)M1(2)	R463W4150(1)M1(2)
2.2	11.0	22.0	41.5	37.5	100	463W4220(1)M2(3)	R463W4220(1)M2(3)
2.2	13.0	24.0	41.5	37.5	100	463W4220(1)M1(2)	R463W4220(1)M1(2)
3.3	16.0	28.5	41.5	37.5	100	463W4330(1)M1(2)	R463W4330(1)M1(2)
4.7	16.0	28.5	41.5	37.5	100	463W4470(1)M2(3)	R463W4470(1)M2(3)
4.7	19.0	32.0	41.5	37.5	100	463W4470(1)M1(2)	R463W4470(1)M1(2)
6.8	20.0	40.0	41.5	37.5	100	463W4680(1)M2(2)	R463W4680(1)M2(2)
6.8	24.0	44.0	41.5	37.5	100	463W4680(1)M1(2)	R463W4680(1)M1(2)
10.0	30.0	45.0	41.5	37.5	100	463W5100(1)M1(2)	R463W5100(1)M1(2)
Capacitance Value (µF)	B (mm)	H (mm)	L (mm)	Lead Spacing (p)	dV/dt (V/µs)	New KEMET Part Number	Legacy Part Number

(1) Insert lead and packaging code. See Ordering Options Table for available options.

(2) M = ±20%, K = ±10%

(3) M = ±20% (only available tolerance).

## Soldering Process

The implementation of the RoHS directive has resulted in the selection of SnAuCu (SAC) alloys or SnCu alloys as primary solder material. This has increased the liquidus temperature from 183°C for SnPb eutectic alloys to 217 – 221°C for the new alloys. As a result, the heat stress to the components, even in wave soldering, has increased considerably due to higher pre-heat and wave temperatures. Polypropylene capacitors are especially sensitive to heat (the melting point of polypropylene is 160 – 170°C). Wave soldering can be destructive, especially for mechanically small polypropylene capacitors (with lead spacing of 5 – 15 mm). Great care must be taken during soldering. The recommended solder profiles from KEMET should be used. Consult KEMET with any questions. In general, the wave soldering curve from IEC Publication 61760-1 Edition 2 serves as a solid guideline for successful soldering. See Figure 1.

Reflow soldering is not recommended for through-hole film capacitors. Exposing capacitors to a soldering profile in excess of the above-recommended limits may result to degradation of or permanent damage to the capacitors.

Do not place the polypropylene capacitor through an adhesive curing oven to cure resin for surface mount components. Insert through-hole parts after curing surface mount parts. Consult KEMET to discuss the actual temperature profile in the oven, if through-hole components must pass through the adhesive curing process. A maximum two soldering cycles is recommended. Allow time for the capacitor surface temperature to return to normal temperature before performing the second soldering cycle.

### Manual Soldering Recommendations

Following is the recommendation for manual soldering with a soldering iron.

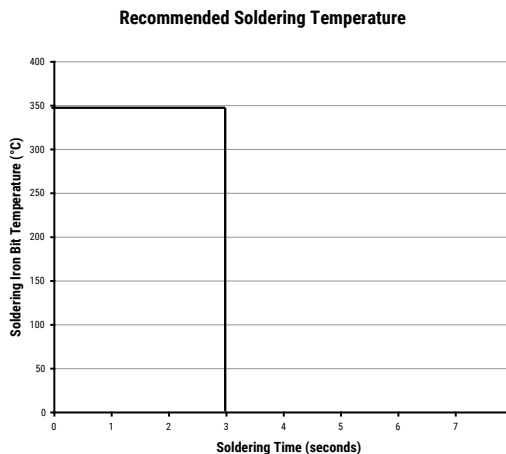

The soldering iron tip temperature should be set at 350°C (+10°C maximum), with the soldering duration not to exceed more than 3 seconds.

### Wave Soldering Recommendations

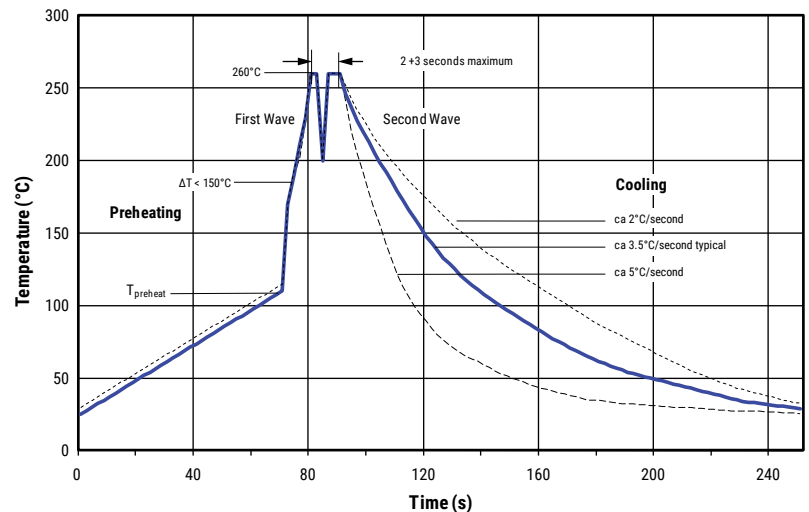

## Soldering Process cont.

### Wave Soldering Recommendations cont.

1. The table indicates the maximum set-up temperature of the soldering process.

Dielectric Film Material	Maximum Preheat Temperature		Maximum Peak Soldering Temperature	
	Capacitor Pitch ≤ 15 mm	Capacitor Pitch > 15 mm	Capacitor Pitch ≤ 15 mm	Capacitor Pitch > 15 mm
Polyester	130°C	130°C	270°C	270°C
Polypropylene	110°C	130°C	260°C	270°C
Paper	130°C	140°C	270°C	270°C
Polyphenylene Sulphide	150°C	160°C	270°C	270°C

2. The maximum temperature measured inside the capacitor: set the temperature so that the maximum temperature inside the element is below the limit.

Dielectric Film Material	Maximum Temperature Measured Inside the Element
Polyester	160°C
Polypropylene	110°C
Paper	160°C
Polyphenylene Sulphide	160°C



*Temperature monitored inside the capacitor.*

### Selective Soldering Recommendations

Selective dip soldering is a variation of reflow soldering. In this method, the printed circuit board with through-hole components to be soldered is preheated and transported over the solder bath as it is in normal flow soldering, without touching the solder. When the board is over the bath, it is stopped. Pre-designed solder pots are lifted from the bath with molten solder, only at the places of the selected components, and pressed against the lower surface of the board to solder the components.

The temperature profile for selective soldering is similar to the double wave flow soldering outlined in this document.

**However, instead of two baths, there is only one with a time from 3 – 10 seconds.** In selective soldering, the risk of overheating is greater than in double wave flow soldering, and great care must be taken so that the parts do not overheat.

## Construction

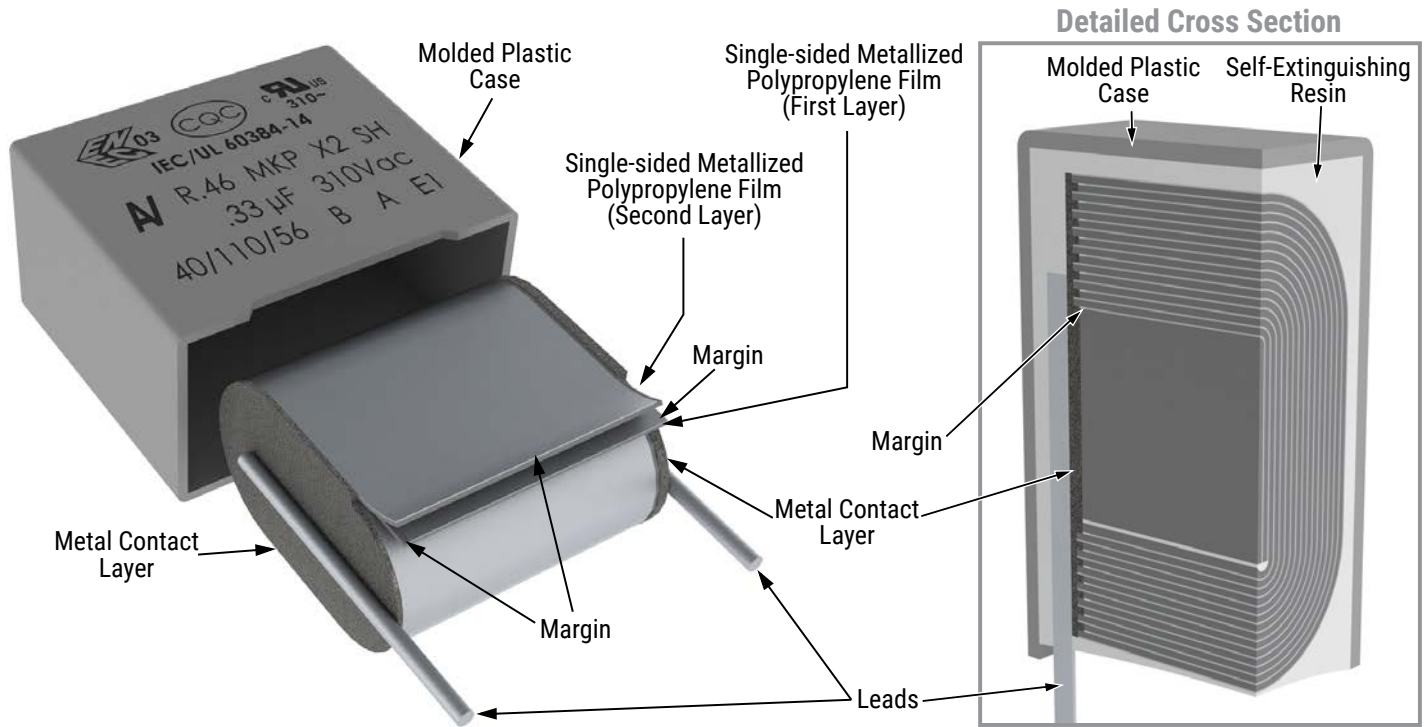

## Winding Scheme

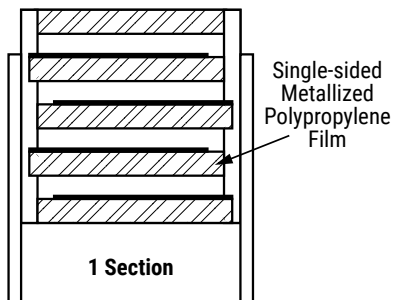

## Marking

### Lead Spacing 10 mm

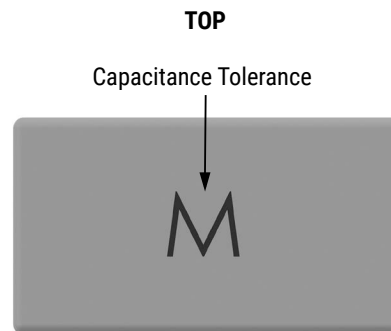
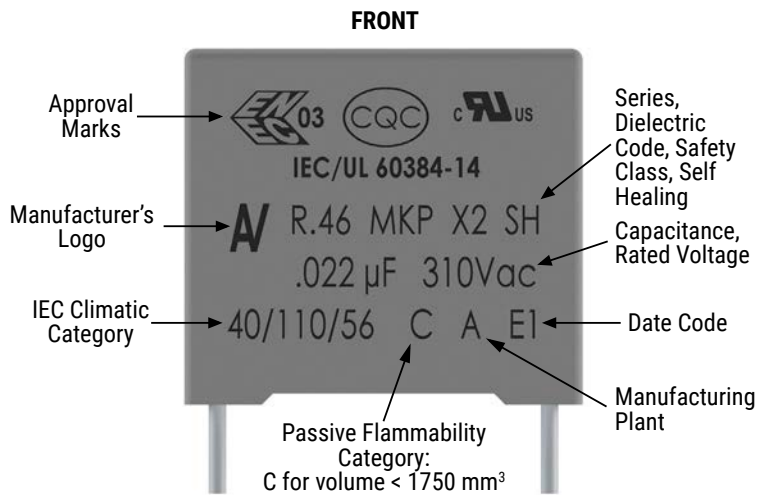

*NOTE: Hot imprinting with or without color or ink jet or laser marking*

### Lead Spacing 15 mm, 22.5 mm, and 27.5 mm

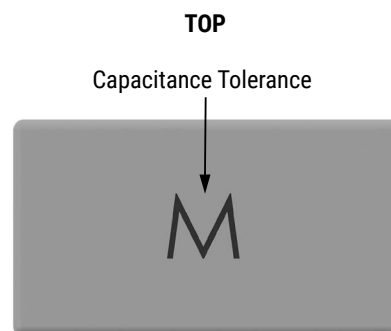
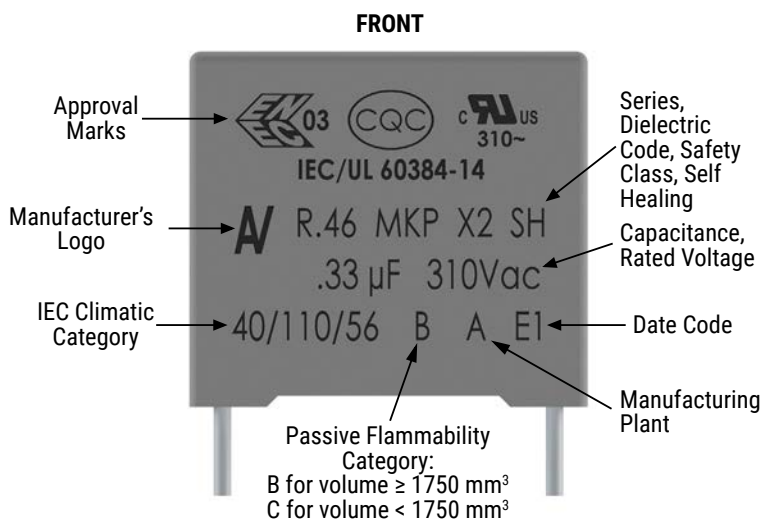

*NOTE: Hot imprinting with or without color or ink jet or laser marking*

## Marking cont.

Lead Spacing 22.5 and 27.5 mm (alternatives\*) and 37.5 mm

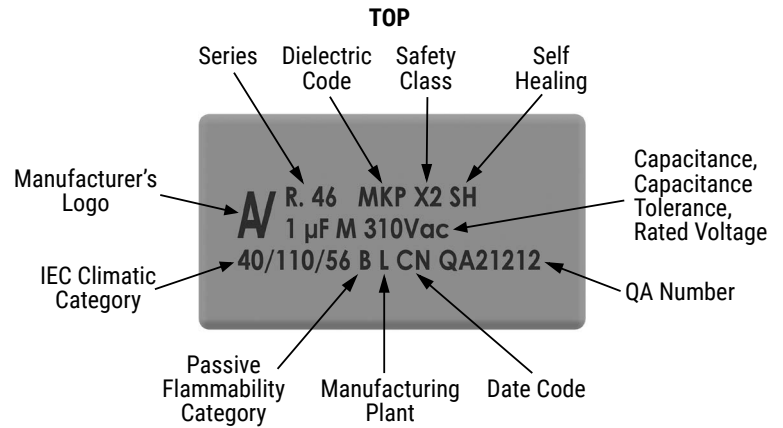
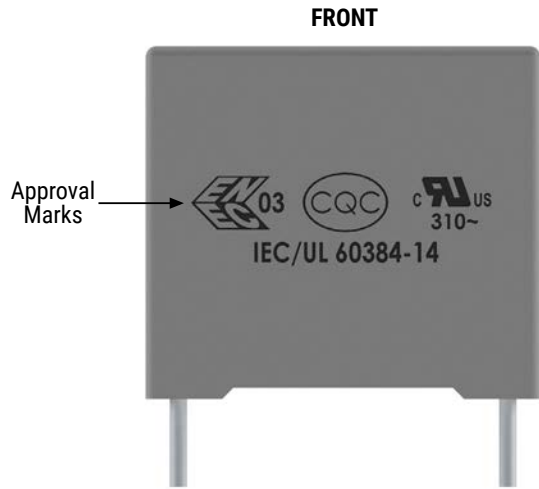

*\*Differences are caused by technology (clichee, laser, or ink) and production line.*

Manufacturing Date Code (IEC-60062)			
Y = Year, Z = Month			
Year	Code	Month	Code
2000	M	January	1
2001	N	February	2
2002	P	March	3
2003	R	April	4
2004	S	May	5
2005	T	June	6
2006	U	July	7
2007	V	August	8
2008	W	September	9
2009	X	October	0
2010	A	November	N
2011	B	December	D
2012	C		
2013	D		
2014	E		
2015	F		
2016	H		
2017	J		
2018	K		
2019	L		
2020	M		

## Packaging Quantities

Lead Spacing (mm)	Thickness (mm)	Height (mm)	Length (mm)	Bulk Short Leads	Bulk Long Leads	Standard Reel ø 355 mm	Large Reel ø 500 mm	Ammo Taped
10	4	9	13	2,000	1,800	750	1,500	1,000
	5	11	13	1,300	1,500	600	1,250	800
	6	12	13	1,000	1,200	500	1,000	680
15	5	11	18	2,000	1,000	600	1,250	800
	6	12	18	1,750	900	500	1,000	680
	6	17.5	18	1,000	700	500	1,000	680
	7.5	13.5	18	1,000	700	350	800	500
	7.5	18.5	18	900	500	-	800	500
	8.5	14.5	18	1,000	500	300	700	440
	9	12.5	18	1,000	520	270	650	410
	10	16	18	750	500	300	600	380
	11	19	18	450	350	-	500	340
13	12	18	750	490	200	480	280	
22.5	6	15	26.5	805	500	-	700	464
	7	16	26.5	700	500	-	550	380
	10	18.5	26.5	396	300	-	350	235
	11	20	26.5	360	250	-	350	217
	13	22	26.5	300	200	-	300	-
27.5	9	17	32	816	408	-	450	-
	11	20	32	560	336	-	350	-
	13	22	32	480	288	-	300	-
	13	25	32	480	288	-	-	-
	14	28	32	352	176	-	-	-
	18	33	32	256	128	-	-	-
	22	37	32	168	112	-	-	-
37.5	11	22	41.5	420	252	-	-	-
	13	24	41.5	360	216	-	-	-
	16	28.5	41.5	216	108	-	-	-
	19	32	41.5	192	96	-	-	-
	20	40	41.5	126	84	-	-	-
	24	44	41.5	108	72	-	-	-
	30	45	41.5	90	60	-	-	-



## Lead Taping & Packaging (IEC 60286-2)

**Figure 1**  
Lead Spacing 10 mm



**Figure 2**  
Lead Spacing 15 mm

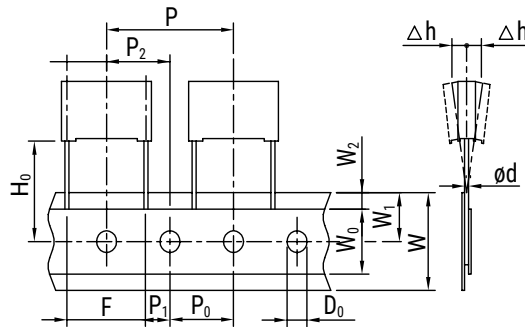

**Figure 3**  
Lead Spacing 22.5 – 27.5 mm



## Taping Specification

Description	Symbol	Dimensions (mm)					Tol.
		Lead Space					
		10 Fig. 1	15 Fig. 2	22.5 Fig. 3	27.5 Fig. 3		
Lead wire diameter	d	0.6	0.6-0.8	0.8	0.8	±0.05	
Taping lead space	P	25.4	25.4	38.1	38.1	±1	
Feed hole lead space *	P <sub>0</sub>	12.7	12.7	12.7	12.7	±0.2 **	
Centering of the lead wire	P <sub>1</sub>	7.7	5.2	7.8	5.3	±0.7	
Centering of the body	P <sub>2</sub>	12.7	12.7	19.05	19.05	±1.3	
Lead spacing (pitch) ***	F	10	15	22.5	27.5	+0.6/-0.1	
Component alignment	Δh	0	0	0	0	±2	
Height of component from tape center	H <sub>0</sub> ****	18.5	18.5	18.5	18.5	±0.5	
Carrier tape width	W	18	18	18	18	+1/-0.5	
Hold down tape width	W <sub>0</sub>	9	10	10	10	Minimum	
Hole position	W <sub>1</sub>	9	9	9	9	±0.5	
Hold down tape position	W <sub>2</sub>	3	3	3	3	Maximum	
Feed hole diameter	D <sub>0</sub>	4	4	4	4	±0.2	
Total tape thickness	t	0.7	0.7	0.7	0.7	±0.2	

\* 15 mm also available

\*\* Maximum of 1 mm on 20 lead spaces

\*\*\* Pitches 15 mm and 10 mm taped to 7.5 mm (crimped leads) available upon request

\*\*\*\* H<sub>0</sub> = 16.5 mm is available upon request

## Lead Taping & Packaging (IEC 60286-2) cont.

### Ammo Specifications

Dimensions (mm)		
H	W	T
360	340	59



### Reel Specifications

Reel Size	Dimensions (mm)		
	D	H	W
Standard	355	30	55 Maximum
Large	500	25	



## KEMET Electronics Corporation Sales Offices

For a complete list of our global sales offices, please visit [www.kemet.com/sales](http://www.kemet.com/sales).

---

### Disclaimer

All product specifications, statements, information and data (collectively, the "Information") in this datasheet are subject to change. The customer is responsible for checking and verifying the extent to which the Information contained in this publication is applicable to an order at the time the order is placed. All Information given herein is believed to be accurate and reliable, but it is presented without guarantee, warranty, or responsibility of any kind, expressed or implied.

Statements of suitability for certain applications are based on KEMET Electronics Corporation's ("KEMET") knowledge of typical operating conditions for such applications, but are not intended to constitute – and KEMET specifically disclaims – any warranty concerning suitability for a specific customer application or use. The Information is intended for use only by customers who have the requisite experience and capability to determine the correct products for their application. Any technical advice inferred from this Information or otherwise provided by KEMET with reference to the use of KEMET's products is given gratis, and KEMET assumes no obligation or liability for the advice given or results obtained.

Although KEMET designs and manufactures its products to the most stringent quality and safety standards, given the current state of the art, isolated component failures may still occur. Accordingly, customer applications which require a high degree of reliability or safety should employ suitable designs or other safeguards (such as installation of protective circuitry or redundancies) in order to ensure that the failure of an electrical component does not result in a risk of personal injury or property damage.

Although all product-related warnings, cautions and notes must be observed, the customer should not assume that all safety measures are indicated or that other measures may not be required.

*KEMET is a registered trademark of KEMET Electronics Corporation.*

# Mouser Electronics

Authorized Distributor

Click to View Pricing, Inventory, Delivery & Lifecycle Information:

## KEMET:

[R463R422000M1K](#) [R463W447000M1K](#) [R463F3100DQM1M](#) [R463I310000M1K](#) [R463I322000M2K](#)  
[R463I333000N0M](#) [R463N333000N0M](#) [R463N347000N0M](#) [R463N4100CKN2M](#) [R463R410000M1M](#)  
[R463R410050M1K](#) [R463R4100CKM1K](#) [R463R415000M1K](#) [R463R433000M2M](#) [R463R447000M2K](#)  
[R463W447000M2M](#) [R463W456000M1M](#) [R463W510000M1M](#) [R463F2100CKM1M](#) [R463F2100JBM1M](#)  
[R463F247000M1M](#) [R463F310000M1M](#) [R463F310050M1M](#) [R463I21000001M](#) [R463I21004001K](#) [R463I21004001M](#)  
[R463I21005001K](#) [R463I22204001M](#) [R463I22205001K](#) [R463I2220CK01K](#) [R463I2220CKH1K](#) [R463I2220JB01M](#)  
[R463I2220ZC01M](#) [R463I2330JB01M](#) [R463I24700001M](#) [R463I24704001M](#) [R463I24705001K](#) [R463I2470JB01M](#)  
[R463I26800001M](#) [R463I2680DQ01K](#) [R463I2680JB01M](#) [R463I31000001M](#) [R463I310000M1M](#) [R463I310040M1M](#)  
[R463I31005001K](#) [R463I310050M1M](#) [R463I3100BM01K](#) [R463I3100CKM1M](#) [R463I3100JBM1M](#) [R463I315000M2M](#)  
[R463I315045M2M](#) [R463I315050M1K](#) [R463I315050M2M](#) [R463I3150DQM1K](#) [R463I3150JHM1K](#) [R463I3150NEM1K](#)  
[R463I32200002M](#) [R463I322000H3M](#) [R463I322000M1K](#) [R463I322000M2M](#) [R463I322050H4M](#) [R463I322050L2K](#)  
[R463I322050M1K](#) [R463I322050M2M](#) [R463I3220NDL2K](#) [R463I3220NEL2K](#) [R463I3220NFM2M](#) [R463I33305001K](#)  
[R463I333050M1K](#) [R463I333050M1M](#) [R463I3330DQ01K](#) [R463I3330JH01K](#) [R463I3330JHM1K](#) [R463I347000M1K](#)  
[R463I347000M1M](#) [R463I347045M1M](#) [R463I347050H1M](#) [R463I347050M1M](#) [R463I3470DQM1K](#) [R463I3470JHM1K](#)  
[R463N31500001M](#) [R463N3150JH01M](#) [R463N322040M1K](#) [R463N32205001K](#) [R463N3220DQM1M](#)  
[R463N333000M1M](#) [R463N333040M1K](#) [R463N333040M1M](#) [R463N333050M1K](#) [R463N333050M1M](#)  
[R463N3330CKM1M](#) [R463N3330JHM1M](#) [R463N347000M1K](#) [R463N347000M1M](#) [R463N347040M1K](#)  
[R463N347050M1K](#) [R463N347050M1M](#) [R463N3470JBM1M](#) [R463N3470JHM1M](#) [R463N368000M2K](#)