

MS

CONNECTORS

according to MIL-C-5015

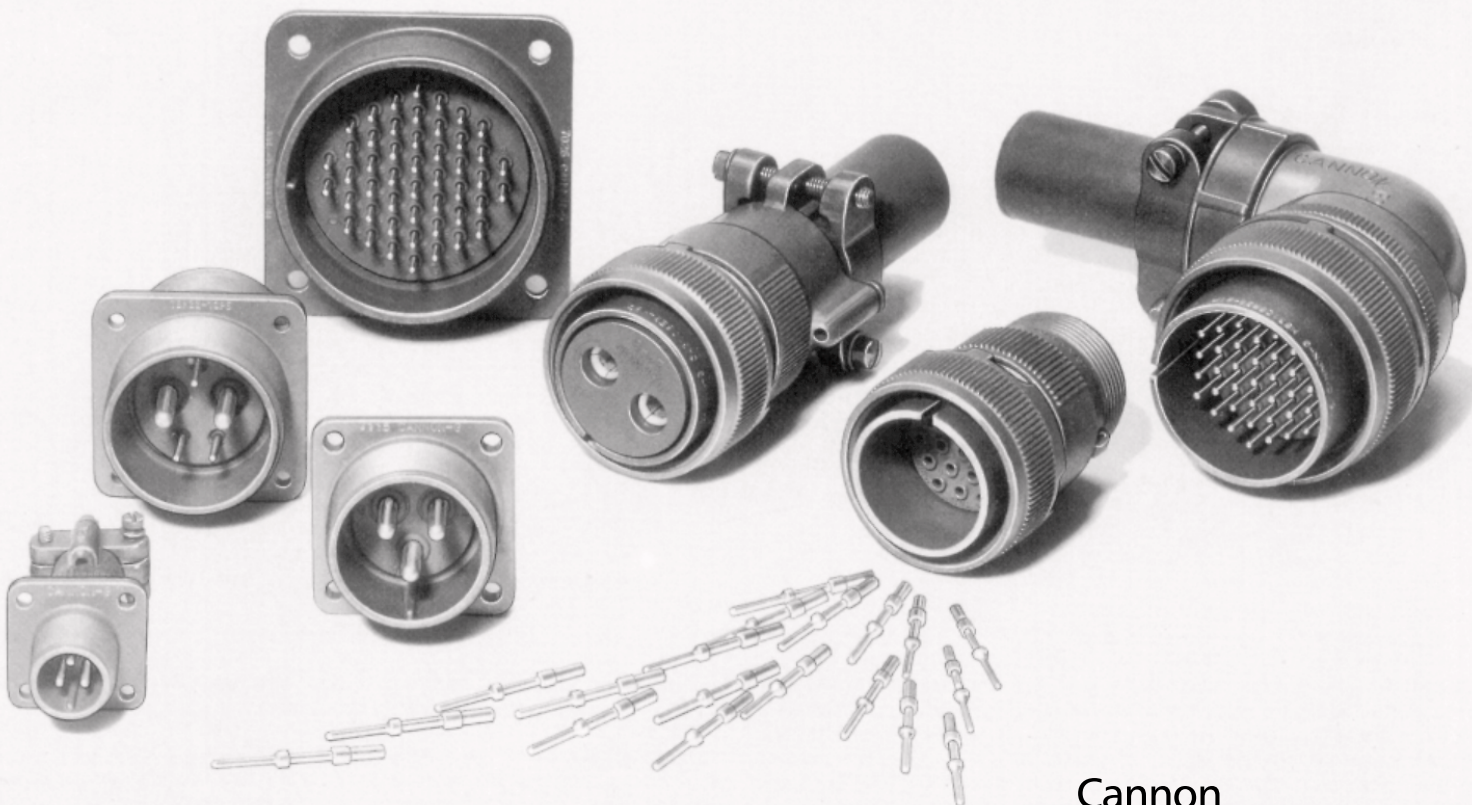

Contents

General Information 2
 Shell Styles 3
 Technical Data 4
 Part number Explanation 5
 Contact Arrangements 6
 Wall Mounting Receptacle 17
 Cable Connecting Plug 18
 Box Mounting Receptacle 19
 Straight Plug 19
 90° Angle Plug 20
 Straight Plug, CA-F Type 21
 Straight Plug, CA-E Type 22
 Through-Bulkhead 22
 Accessories 23
 Contacts 27
 Tooling 29
 Product Safety Information 30

Introduction

This catalogue describes Cannon connectors designed and manufactured to MIL-C-5015, the military specification covering MS electrical connectors. These connectors were originally designed for aircraft, but are now widely used in many other fields. They are particularly suitable for commercial applications requiring low cost and high reliability.

The design of connector classes MS-E, MS-F and MS-R conforms to MIL-C-5015 D. The new class F connectors supersede the previous class E connectors. For new programs only class F should be ordered. The coupling measurements as well as the dimensions of class MS-E, -F and -R are in accordance with the latest revision of VG 0095342. Wall mount receptacle, box receptacle, cable connector and straight plug have the same coupling dimensions. This allows mating of the different classes of these connectors.

The connectors of class E, F and R are designed to operate in extreme environmental conditions. These connectors are completely sealed to withstand moisture, condensation, vibration and flash-over. MS-F and MS-R connectors have a resilient grommet around each wire. This allows the wires to slide through the grommet with a minimum of friction. Yet when the ferrule is sealed and the endbells are tightened, it provides perfect wire seal through a wide variety of wire diameters. This seal at the rear plus the interfacial seal at the front, effect a completely environmental resistant assembly when the plug is mated to an F or R receptacle.

Different Classes

Connector classes MS 3106F, MS 3106R and MS 3108R feature an O-ring under the coupling nut. It is missing on connectors class MS 3106E and MS 3108E.

To reduce size and weight, connector classes MS 3100R, MS 3101R and MS 3106R have no cable strain relief. The 90° angle plug MS 3106R has no cable clamp and is suitable for hose connection. Strain relief for this connector has to be ordered separately (see page 23). Moreover, construction and materials used are identical for all connector classes.

Different Designations

Connectors with MS designation conform to MIL-C-5015 in respect of dimensions and contact arrangements.

Deviations from this specification, e. g. crimp contacts, other shell or contact finishes, are designated CA.

Design Features

Straight Plug (E- and F-Types)									O Ring MS-F only
Straight Plug (R-Type)									
Bushing	Endbell	Ferrule	Grommet	Pin contacts	Insulator	Coupling Nut	Barrel	O Ring	

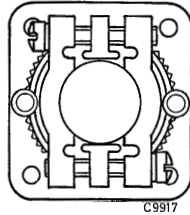
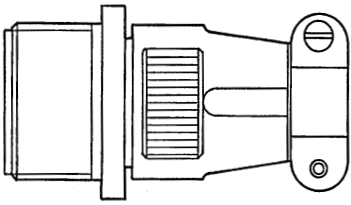

Wall mounting receptacles MS 3100E and F / CA 3100E
Dimensions / sizes

Page 17

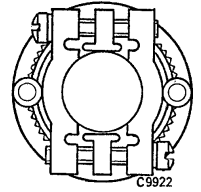
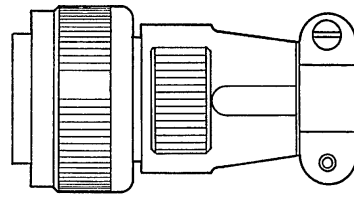

Straight plug MS 3106E and F / CA 3106E and CA06R
Dimensions / sizes

Page 19

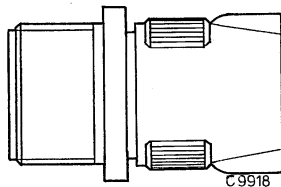
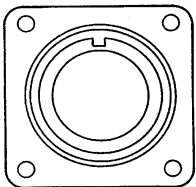

Wall mounting receptacle MS 3100R / CA 3100R
Dimensions / sizes

Page 17

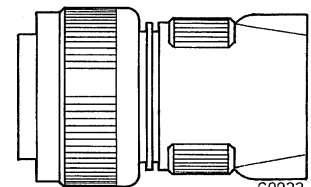
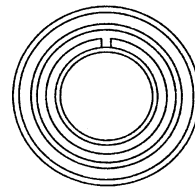

Straight plug MS 3106R / CA 3106R
Dimensions / sizes

Page 20

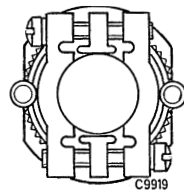
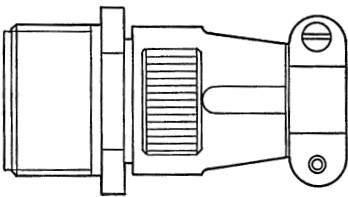

Cable connecting plug MS 3101E and F / CA 3101E
Dimensions / sizes

Page 18

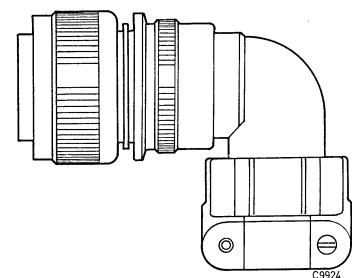
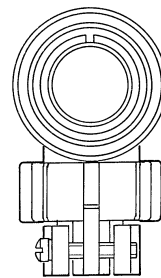

90° Angle plug MS 3108E and R / CA 3108E / R
(MS3108R, CA3108F/R without cable clamp)
Dimensions / sizes

Page 20

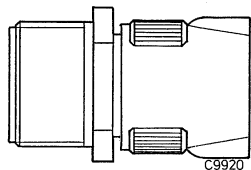
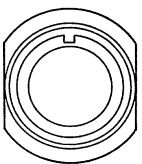

Cable connecting plug MS 3101R / CA 3101R
Dimensions / sizes

Page 18

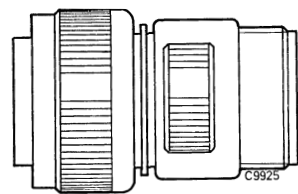
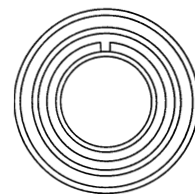

Straight plug CA 3106F
Dimensions / sizes

Page 21

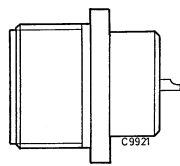
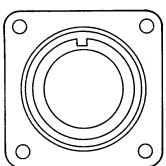

Box mounting receptacle MS 3102E and R / CA 3102E
Dimensions / sizes

Page 19

Accessories: Cable clamps, Telescoping bushings,
Sealing gaskets, Protective caps with and without chain,
Dummy receptacles, etc.

Pages 23 – 26

Standard Data

Shell	Material	Aluminum alloy
	Finish	Olive drab chromate coating over cadmium plating
Insulator	Material	Polychloroprene (resilient) acc. to MI-R-3065
Contacts	Material	Copper alloy or brass
	Finish	Silver plated, solder pot tinned
	Termination	Crimp or solder for AWG and metric contact size

Operating Temperature -55/125°C

Separation Force (N)

Contact sizes	AWG	–	16S/16	12	8	4	0
	Metric	10	15S/15	25	100	160	500
Separation force	N min.	0,3	1,0	1,5	3	4	8,5

Please note:

Connector classes 00E / F, 01E / F, 06E / F and 08E are always delivered with cable bushing. Dimensions of cable bushing see page 22.

Electrical Data

Operating voltage and connector usage

When the connectors in this catalogue are used for voltages greater than 50 Volts and have touchable conductive shell parts they must be used in accordance with the safety regulations DIN VDE Part 410; IEC 60364-4-41. This regulation basically dictates that the power source should be turned off before any mating and unmating of the connector, this regulation does not provide for protection against electrical shock when mating and unmating the connectors in the live condition.

Nominal current and potential drop

Maximum current ratings of contacts and maximum allowable voltage drop under test conditions when assembled as in service are shown below.

Contact size AWG	16S/16	12	8	4	0
Contact size metric	15S/15	25	100	160	500
Wire size mm ²	1,0/1,5	2,5	10	16	50
Current rating A*	22	41	73	135	245
Potential drop mV	6	3	1	0,3	0,2

*measured between the contacts at +25^{±3}°C

Service rating

MS connectors show no evidence of breakdown when the test voltage given below is applied between the two closest contacts and between the shell and the contacts closest to the shell for a period of one minute.

High potential test voltage is conducted in VG 95319 part 2 test no. 5.13 and VG 95210 part 31.

MS Service rating	Instruments	A	D	E
Test voltage Veff 50 Hz	1050	1600	2500	3000
Air spacing mm	0,7	1,1	2,8	4,8
Creeping distance mm	0,7	1,1	2,8	4,8

Part Number Explanation

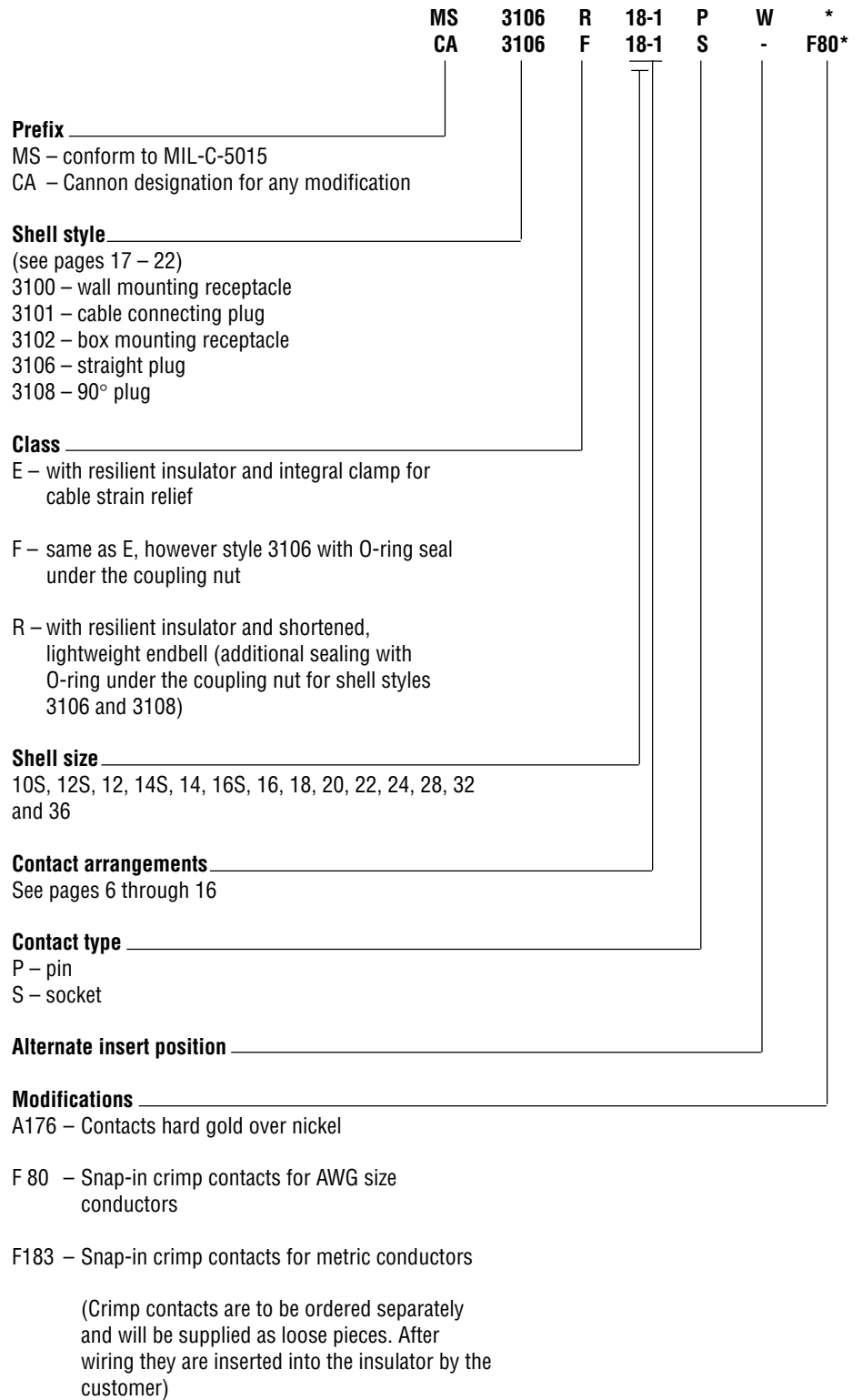

Wire Selection

The connectors are designed for individual wiring. Spray water and moisture resistance are only guaranteed if wires according to MIL-W-5086, LN 9251 (for AWG diameters), TL 6145-009 and TL 6145-011 (for metric diameters) are

used. When using wires which do not correspond to these specifications the wire diameters and outer dimensions of the insulation indicated in below table have to be adhered to.

Contact size	Conductor size for solder contacts		for crimp contacts				Insulation sizes (in mm) for	
	AWG	mm ²	AWG	conductor Ø mm	metric mm ²	conductor Ø mm	AWG contacts	metric contacts
- / 10	-	-	-	-	0,75 1,0	1,0 - 1,4	-	2,0 - 2,5
16S/15S	16-22	1,2 - 0,4	16	1,25 - 1,7	1,0 - 1,7	1,25 - 1,7	1,63 - 3,3	2,2 - 2,8
16 / 15	16-22	1,2 - 0,4	16	1,25 - 1,7	1,0 - 1,5	1,25 - 1,7	1,63 - 3,3	2,2 - 2,8
12 / 15	12-14	3,5 - 2,0	12	1,95 - 2,2	2,5	1,95 - 2,2	2,9 - 4,3	3,1 - 3,5
8 / 100	8 - 10	8,5 - 4,5	8	4,0 - 4,5	10	4,3 - 4,8	2,9 - 6,4	5,9 - 6,5
4 / 160	4 - 6	21,5 - 13,5	4	6,0 - 6,9	16	5,2 - 6,0	7,0 - 9,4	7,1 - 7,7
0 / 500	0 - 2	53,0 - 33,5	0	10,6 - 11,5	50	9,6 - 10,7	10,6 - 14,0	12,1 - 12,8

Contact Arrangements

In the table on pages 7 – 14 the contact arrangements are listed by shell sizes. The shell size and the contact arrangement number are given in the designation printed in bold typefaces: the digits following the dash are the contact arrangement number (see Part Number Explanation on page 5).

Furthermore, the number of contacts and the AWG wire sizes are included in the table. The recommended wire sizes are shown on this page, the electrical data on page 4.

Alternate Insert Positions

Alternate insert positions can be offered to prevent mismatching of adjacent identic connectors.

The standard insert position is without designation. The four alternate positions are designated W, X, Y and Z (see diagram below).

Please note:

All MS qualified insert positions are listed on pages 7 – 14. Other positions than normal are not available from stock.

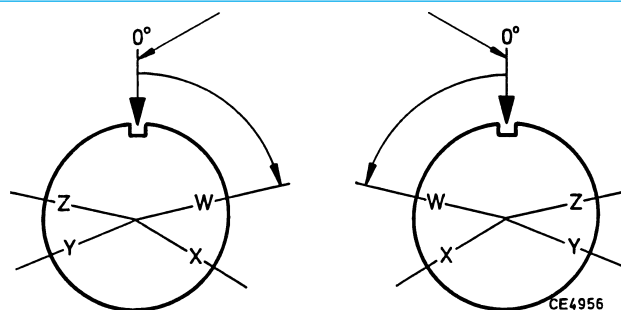

Pin insert front view

Contact Arrangements

	No. of contacts	Contact arrangement Contact size AWG	Service rating	Insulator position – see diagram on page 6				Insulator weight (g) including contacts	
				W	X	Y	Z	pin	socket
	3	10SL-3 ●▼ 16S	A	-	-	-	-	6	9
	2	10SL-4 16S	A	-	-	-	-	4	6
	2	12S-3 ●+ 16S	A	70	145	215	290	4	6
	1	12-5 ● 12	D	-	-	-	-		
	3	14S-1 16S	A	-	-	-	-	6	9
	4	14S-2 + 16S	Inst.	-	120	240	-	7	11
	5	14S-5 ●+ 16S	Inst.	-	110	-	-	9	13
	6	14S-6 ●▼ 16S	Inst.	-	-	-	-	11	15
	3	14S-7 ●+ 16S	A	90	180	270	-	6	9

● MIL-C-5015 contact arrangement ▼ VG95234 contact arrangement + MS polarization

Contact Arrangements

	No. of contacts	Contact arrangement Contact size AWG	Service rating	Insulator position – see diagram on page 6				Insulator weight (g) including contacts	
				W	X	Y	Z	pin	socket
	2	14S-9+ 16S	INST	70	145	215	290	5	18
	7	16S-1 ●▼+ 16S	A	80	-	-	280	14	19
	5	16S-8 ●+ 16S	A	-	170	265	-	10	15
	3 2 1	16-7+ 16 (A, B) 8 (C)	A	80	110	250	280	16	25
	4 2 2	16-9 ●+ 16 (B, D) 12 (A, C)	A	35	110	250	325	13	20
	3	16-10 ●▼ 12	A	90	180	270	-	17	24
	2	16-11 ●+ 12	A	35	110	250	325	11	17
	1	16-12 4	A	0	-	-	-	24	28
	10	18-1 ▼+ 16	A (B, C, F, G) INST (all other)	70	145	-	290	24	37
	2	18-3+ 12	D	-	-	-	-	13	22
	4	18-4 ●+ 16	D	35	110	250	325	19	30

● MIL-C-5015 contact arrangement

▼ VG95234 contact arrangement

+ MS polarization

Contact Arrangements

	No. of contacts	Contact arrangement Contact size AWG	Service rating	Insulator position – see diagram on page 6				Insulator weight (g) including contacts	
				W	X	Y	Z	pin	socket
	3 1 2	18-5 ●+ 16 (A) 12 (B,C)	D	80	110	250	280	15	25
	8 7 1	18-8 ●+ 16 (A-G) 12 (H)	A	70	-	-	290	18	30
	7 5 2	18-9 ●+ 16 (B,C,E-G) 12 (A,D)	INST	80	110	250	280	18	30
	4	18-10 + 12	A	-	120	240	-	13	22
	5	18-11 ●+ 12	A	-	170	265	-	31	40
	6	18-12 + 16	A	80	-	-	280	15	25
	4 3 1	18-13 ●+ 12 (B,C) 8 (A)	A	80	110	250	280	15	24
	1	20-2 ●▼ 0	D	-	-	-	-	46	55
	4	20-4 ●+ 12	D	45	110	250	-	24	40
	8	20-7 ●+ 16	A (C-F) D (A;B;G;H)	80	110	250	280	28	42
	6 4 2	20-8 ● 16 (B;C;E;F) 8 (A;D)	INST	80	110	250	280	37	49
	9	20A9 ● 12	D (J) A (all other)	-	-	-	-	21	35

● MIL-C-5015 contact arrangement

▼ VG95234 contact arrangement

+ MS polarization

Contact Arrangements

	No. of contacts	Contact arrangement Contact size AWG	Service rating	Insulator position – see diagram on page 6				Insulator weight (g) including contacts	
				W	X	Y	Z	pin	socket
	19	20A48 ▼ 16	INST	-	80	280	-	30	50
	7	20-15 + 12	A	80	-	-	280	27	46
	9 7 2	20-16 ●+ 16 (A-G) 12 (H;I)	A	80	110	250	280	19	32
	6 1 5	20-17 ●+ 16 12	A	90	180	270	-	20	33
	3	20-19 + 8	A	90	180	270	-	33	46
	4 2 2	20-24 ●+ 16 (A;C) 8 (B;D)	A	35	110	250	325	40	53
	14	20-27 ●+ 16	A	35	110	250	325	26	42
	17	20-29 ●+ 16	A	80	-	-	280	29	47
	11	20-33 ● 16	A	-	-	-	-	23	38
	3	22-2 ●▼+ 8	D	70	145	215	290	35	50

● MIL-C-5015 contact arrangement

▼ VG95234 contact arrangement

+ MS polarization

Contact Arrangements

	No. of contacts	Contact arrangement Contact size AWG	Service rating	Insulator position – see diagram on page 6				Insulator weight (g) including contacts	
				W	X	Y	Z	pin	socket
	1	22-7 ● 0	E	0	-	-	-	45	57
	3	22-9 ●+ 12	E	70	145	215	290	21	32
	5 3 2	22-12 ●+ 16 (A;C;D) 8 (B;E)	D	80	110	250	280	28	42
	19	22-14 ●+ 16	A	80	-	-	280	30	50
	14	22-19 ●+ 16	A	80	110	250	280	28	47
	9	22-20 + 16	A	35	110	250	325	29	41
	4	22-22 + 8	A	-	110	250	-	38	50
	8	22-23 ●+ 12	D (H) A (all others)	35	-	250	-	34	54
	9 8 1	22-27 ●▼+ 16 (A-H) 8 (J)	D (J) A (all others)	80	-	250	280	31	44
	7	22-28 + 12	A	-	-	-	-	38	54

● MIL-C-5015 contact arrangement ▼ VG95234 contact arrangement + MS polarization

Contact Arrangements

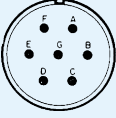
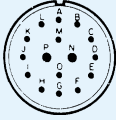
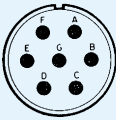
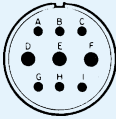
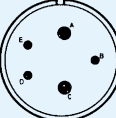
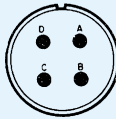
	No. of contacts	Contact arrangement Contact size AWG	Service rating	Insulator position – see diagram on page 6				Insulator weight (g) including contacts	
				W	X	Y	Z	pin	socket
	7	24-2 ●+ 12	D	80	-	-	280	33	53
	16 14 2	24-7 ●+ 16 (A-M,O) 12 (P,N)	A	80	110	250	280	45	65
	7	24-10 ●▼+ 8	A	80	-	-	280	65	85
	9 6 3	24-11 ●▼+ 12 (A-C,G-I) 8 (D;F)	A	35	110	250	325	55	75
	5 3 2	24-12 ▼ 12 4	A	-	-	-	-	60	80
	12	24-19 16	A	-	-	-	-	28	47
	11 9 2	24-20 ●+ 16 (A-D,G-L) 12 (E;F)	D	80	110	250	280	40	60
	4	24-22 ●+ 8	D	45	110	250	-	44	61
	24	24-28 + 16	Inst.	80	110	250	280	40	65

● MIL-C-5015 contact arrangement

▼ VG95234 contact arrangement

+ MS polarization

Contact Arrangements

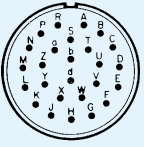
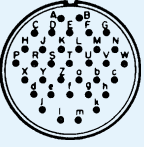
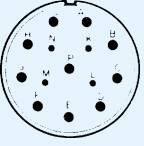
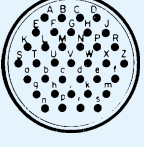
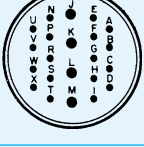
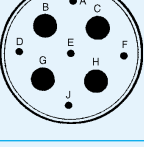
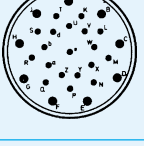
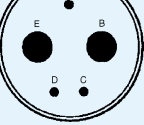
	No. of contacts	Contact arrangement Contact size AWG	Service rating	Insulator position – see diagram on page 6				Insulator weight (g) including contacts	
				W	X	Y	Z	pin	socket
	22 18 4	28-11 + 16 (A-I,N-X) 12 (J-M)	A	80	110	250	280	65	110
	26	28-12 ●+ 16	A	90	180	270	-	47	77
	35	28-15 + 16	A	80	110	250	280	54	90
	14 4 10	28-20 ●+ 16 (K-N) 12 (A-J,P)	A	80	110	250	280	65	110
	37	28-21 ●▼+ 16	A	80	110	250	280	58	93
	9 5 4	28A16 16 (A;D-F;J) 4 (B;C;G;H)	A (e) INST (all other)	-	100	260	-	85	135
	28 9 19	28A63 ▼ 12 16	A (e) INST (all other)	-	-	-	-	85	135
	5 3 2	32-1 ●▼+ 12 (A, C, D) 0 (B, E)	E (A) D (all other)	80	110	250	280	-	-

● MIL-C-5015 contact arrangement ▼ VG95234 contact arrangement + MS polarization

Contact Arrangements

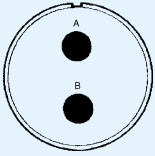
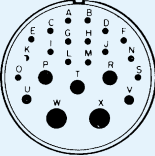
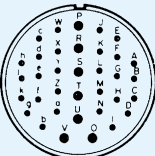
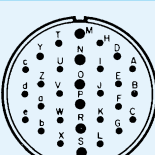
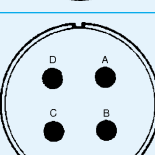
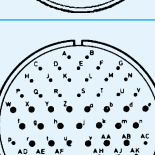
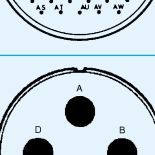
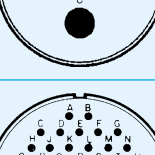
	No. of contacts	Contact arrangement Contact size AWG	Service rating	Insulator position – see diagram on page 6				Insulator weight (g) including contacts	
				W	X	Y	Z	pin	socket
	2	32-5 + 0	D	35	110	250	325	86	114
	23 16 2 3 1	32-6 ●▼+ 16 (A-D;S) 12 (U;V) 8 (P-T) 4 (W;X)	A	80	110	250	280	130	170
	35 28 7	32-7 ●▼+ 16 (A-N;W;Z;a;k) A (all other) 12 (O-V)	INST (A;B;h;i)	80	125	235	280	110	160
	30 24 6	32-8 + 16 (A-L;T-Z;a-e) 12 (M-S)	A	80	125	235	280	105	155
	4	32-17 ●+ 4	D	45	110	250	-	101	128
	61 41 20	32A69 ▼ 20 16	INST	-	110	250	-	49	84
	4	36-5 ●▼+ 0	A	-	120	240	-	152	181
	48	36-10 ●▼+ 16	A	80	125	235	280	79	133

● MIL-C-5015 contact arrangement ▼ VG95234 contact arrangement + MS polarization

Contact arrangement	No. of contacts	Wire size AWG	mm ²	Amp.	Service group	Weight Polychloroprene insert lbs.	gr.	Contact arrangement	No. of contacts	Wire size AWG	mm ²	Amp.	Service group	Weight Polychloroprene insert lbs.	gr.
Shell size 10S/10SL								Shell size 18 (continued)							
10SL-3	3	16	1,5	22	A	P.010 S.017	4 8	18-5	2 1	12 16	2,5 1,5	41 22	D	P.040 S.059	18 27
10SL-4	2	16	1,5	22	A	P.009 S.014	4 6	18-6	1	4	16,0	13,5	D	P.048 S. -	22 -
Shell size 12/12								18-8	1 7	12 16	2,5 1,5	41 22	A	P.044 S.062	20 28
12S-3	2	16	1,5	22	A	P.010 S.016	5 7	18-9	2 5	12 16	2,5 1,5	4 22	Inst.	P.045 S.062	20 28
12-5	1	12	2,5	41	D	P.-	-	18-10	4	12	2,5	41	A	P.046 S.067	21 30
Shell size 14/14S								18-11	5	12	2,5	41	A	P.049 S.071	22 32
14S-1	3	16	1,5	22	A	P.- S.-	- -	18-12	6	16	1,5	22	A	P.039 S.054	18 24
14S-2	4	16	1,5	22	Inst.	P.019 S.028	9 13	18-13	1	8	10,0	73	A	P.- S.-	- -
14S-5	5	16	1,5	22	Inst.	P.017 S.029	8 13	Shell size 20							
14S-6	6	16	1,5	22	Inst.	P.031 S.015	15 7	20-2	1	0	50	245	D	P.092 S.101	41 45
14S-7	3	16	1,5	22	A	P.015 S.024	7 11	20-4	4	12	2,5	41	D	P.057 S.086	26 38
14S-9	2	16	1,5	22	A	P.013 S.022	6 10	20-7	8	16	1,5	22	A (C,D,E,F) D (A,B,H,G)	P.053 S.076	26 34
Shell size 16/16S								20-15	7	12	2,5	41	A	P.068 S.100	30 45
16S-1	7	16	1,5	22	A	P.025 S.042	11 19	20-16	2 7	12 16	2,5 1,5	41 22	A	P.059 S.084	26 38
16-7	1 2	8 16	10,0 1,5	73 22	A	P.- S.-	- -	20-17	5 1	12 16	2,5 1,5	41 22	A	P.068 S.098	31 38
16S-8	5	16	1,5	22	A	P.023 S.039	10 18	20-19	3	8	10,0	73	A	P.068 S.091	31 41
16S-9	5	16	1,5	22	A	P.023 S.039	10 18	20-24	2 2	8 16	10,0 1,5	73 22	A	P.062 S.085	28 38
16-9	2 2	12 16	2,5 1,5	41 22	A A	P.031 S.044	14 20	20-27	14	16	1,5	22	A	P.062 S.082	28 37
16-10	3	12	2,5	41	A	P.031 S.047	14 21	20-29	17	16	1,5	22	A	P.065 S.085	29 38
16-11	2	12	2,5	41	A	P.028 S.042	13 19	20-33	11	16	1,5	22	A	P.057 S.079	25 35
16-12	1	4	16,0	135	A	P.031 S.047	14 21	20A9	9	-	2,5	41	D for J	P.020 S.033	9 15
Shell size 18								20A48	19	-	1,5	22	Inst.	P.020 S.036	16
18-1	10	18	1,5	22	A (B,C,F,G) Inst. (all others)	P.044 S.058	20 26	20-8	4 2	16 8	1,5 10	22 73	Inst.	P.059 S.080	26 36
18-3	2	12	2,5	41	D	P.038 S.057	17 26								
18-4	4	16	1,5	22	D	P.037 S.053	17 24								

Contact arrangement	No. of contacts	Wire size AWG	mm ²	Amp.	Service group	Weight Polychloroprene insert lbs.	gr.	Contact arrangement	No. of contacts	Wire size AWG	mm ²	Amp.	Service group	Weight Polychloroprene insert lbs.	gr.
Shell size 22								Shell size 28							
22-2	3	8	10	73	D	P.077 S.104	34 47	28-11	4 18	12 16	2,5 1,5	41 22	A	P.131 S.182	59 53
22-7	1	0	50	245	E	P.101 S.-	-	28-12	26	16	1,5	22	A	P.127 S.172	57 78
22-9	3	12	2,5	41	E	P.062 S.092	28 42	28-15	35	16	1,5	22	A	P.139 S.181	63 82
22-12	2 3	8 16	10 1,5	73 22	D	P.072 S.100	32 45	28-20	10 4	12 16	2,5 1,5	41 22	A	P.134 S.196	80 89
22-14	19	16	1,5	22	A	P.077 S.100	34 45	28-21	37	16	1,5	22	A	P.142 S.183	64 83
22-19	14	16	1,5	22	A	P.070 S.095	31 43	28A16	4 5	4 16	16 1,5	135 22	A	P.- S.-	- -
22-20	9	16	1,5	22	A	P.063 S.090	29 41	28A63	19 9	- -	1,5 2,5	22 41	A	P.042 S.077	19 35
22-22	4	8	10	73	A	P.085 S.112	38 50	Shell size 32							
22-23	8	12	2,5	41	D (H) A (all others)	P.080 S.118	36 53	32-1	2 3	0 12	50 2,5	245 41	E (A) D (all others)	P.- S.-	- -
22-27	1 8	8 16	10 2,5	73 22	A (H) D (J)	P.070 S.097	31 44	32-5	2	0	50	245	D	P.- S.-	- -
22-28	7	12	2,5	41	A	P.086 S.120	38 54	32-6	2 3 2 16	4 8 12 16	16 10 2,5 1,5	135 73 41 22	A	P.-223 S.287	101 130
Shell size 24								32-7	7	12	2,5	41	Inst. (A,B,h,i) D (all others)	P.198 S.274	89 124
24-2	7	12	2,5	41	D	P.089 S.133	40 60	28	16	1,5	22	245	D	P.198 S.274	89 124
24-7	2 14	12 16	2,5 1,5	41 22	A	P.090 S.125	40 56	32-8	6 24	12 16	2,5 1,5	41 22	A	P.189 S.265	86 120
24-10	7	8	10	73	A	P.125 S.157	56 71	32-17	4	4	16	135	D	P.223 S.283	101 129
24-11	3 6	8 12	10 2,5	73 41	A	P.111 S.153	50 69	32A69	41 20	- -	1,0 1,5	7,5 22	Inst.	P.119 S.121	54 55
24-12	3 2	12 4	10 16	41 135	A	P.027 S.051	12 23	Shell size 36							
24-19	12	16	1,5	22	A	P.- S.-	- -	36-5	4	0	50	245	A	P.- S.-	-
24-20	2 9	12 16	2,5 1,5	41 22	D	P.083 S.120	37 54	36-10	48	16	1,5	22	A	P.214 S.321	97 145
24-22	4	8	10	73	D	P.- S.132	- 59	For additional contact arrangements please consult factory.							
24-28	24	16	1,5	22	Inst.	P.096 S.126	43 57								

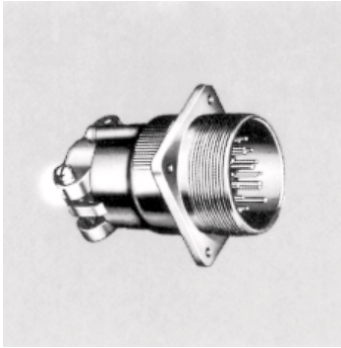

MS3100E / CA3100E / MS3100F

MS3100E and F are wall mounting receptacles which mate with 3106 and 3108 plugs.

Note: MS3100E corresponds to MS3100F and is available upon request. For new programs please order MS3100F only.

If crimp version is required please order CA3100E...F80 or CA3100E...F183

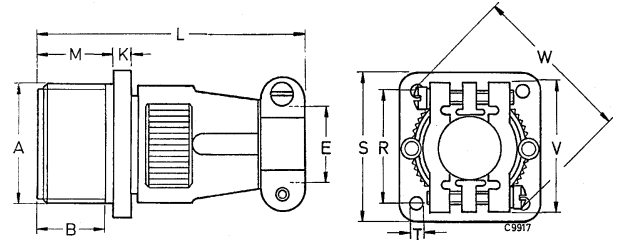

Order reference	A	B	E ¹⁾	K	L	M	R	S	V	W	T
Pin insert*	Thread	min.	max.	±0,7	max.	+0,4	±0,1	±0,3	max.	max.	+0,2 / -0,1
MS3100E10SL-**P	5/8-24 EF-2A	9,5	6,5	3,0	60	14,2	18,2	25,4	22,7	27,0	3,1
MS3100E12S-**P	3/4-20UNEF-2A	9,5	6,5	3,0	60	14,2	20,6	28,0	22,7	27,0	3,1
MS3100E14S-**P	1/8-20UNEF-2A	9,5	9,0	3,0	70	14,2	23,0	30,0	27,5	34,0	3,1
MS3100E16S-**P	1 -20UNEF2A	9,5	11,0	3,0	70	14,2	24,6	32,5	30,0	38,0	3,1
MS3100E12-**P	3/4-20UNEF-2A	15,8	6,5	3,0	70	19,0	20,6	28,0	22,7	27,0	3,1
MS3100E14-**P	7/8-20UNEF-2A	15,8	9,0	3,0	70	19,0	23,0	30,0	27,5	34,0	3,1
MS3100E16-**P	1 -20UNEF-2A	15,8	11,0	3,0	70	19,0	24,6	32,5	30,0	38,0	3,1
MS3100E18-**P	1-1/8-18NEF-2A	15,8	14,2	3,9	77	19,0	27,0	35,0	32,2	40,5	3,1
MS3100E20-**P	1-1/4-18NEF-2A	15,8	15,8	3,9	77	19,0	29,4	38,0	37,5	47,5	3,1
MS3100E22-**P	1-3/8-18NEF-2A	15,8	15,8	3,0	77	19,0	31,8	41,0	37,5	47,5	3,1
MS3100E24-**P	1-1/2-18NEF-2A	15,8	21,4	3,9	77	20,6	34,9	44,5	43,3	54,0	3,7
MS3100E28-**P	1-3/4-18NS-2A	15,8	21,4	3,0	85	20,6	39,7	50,8	43,3	54,0	3,7
MS3100E32-**P	1 -18NS-2A	15,8	26,7	3,9	85	22,2	44,5	57,0	51,7	64,5	4,4
MS3100E36-**P	2-1/4-16UN-2A	15,8	31,7	3,9	105	22,2	49,2	63,5	58,0	73,0	4,4

*For socket inserts substitute S for P **Add contact arrangement number (see pages 7 – 14) ¹⁾ maximum cable diameter



MS3100R / CA3100R

The MS3100R receptacles feature a shorter and lightweight endbell and mate with 3106 and 3108 plugs.

If crimp version is required please order CA3100R...F80 or CA3100R...F183

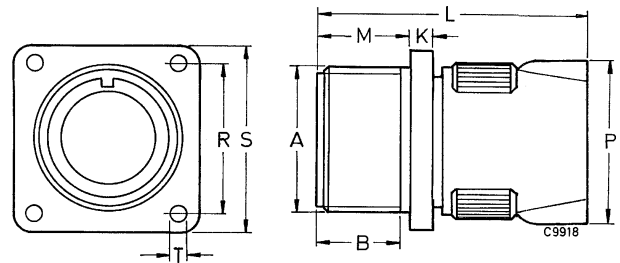

Order reference	A	B	K	L	M	P	R	S	T
Pin insert*	Thread	min.	±0,7	max.	+0,4	max.	±0,1	±0,3	+0,2 / -0,1
MS3100R10SL-**P	5/8-24NEF-2A	9,5	3,0	45	14,2	24,4	18,2	25,4	3,1
MS3100R12S-**P	3/4-20UNEF-2A	9,5	3,0	45	14,2	24,4	20,6	28,0	3,1
MS3100R14S-**P	7/8-20UNEF-2A	9,5	3,0	55	14,2	29,0	23,0	30,0	3,1
MS3100R16S-**P	1 -20UNEF-2A	9,5	3,0	55	14,2	31,5	24,6	32,5	3,1
MS3100R12-**P	3/4-20UNEF-2A	15,8	3,0	55	19,0	24,4	20,6	28,0	3,1
MS3100R14-**P	7/8-20UNEF-2A	15,8	3,0	55	19,0	29,0	23,0	30,0	3,1
MS3100R16-**P	1 -20UNEF-2A	15,8	3,0	55	19,0	31,5	24,6	32,5	3,1
MS3100R18-**P	1 1/8-18NEF-2A	15,8	3,9	60	19,0	36,6	27,0	35,0	3,1
MS3100R20-**P	1-1/4-18NEF-2A	15,8	3,9	60	19,0	39,7	29,4	38,0	3,1
MS3100R22-**P	1-3/8-18NEF-2A	15,8	3,9	60	19,0	39,7	31,8	41,0	3,1
MS3100R24-**P	1-1/2-18NEF-2A	15,8	3,9	60	20,6	47,4	34,9	44,5	3,7
MS3100R26-**P	1-3/4-18 S-2A	15,8	3,9	67	20,6	47,4	39,7	50,8	3,7
MS3100R32-**P	2 -18NS-2A	15,8	3,9	67	22,2	55,9	44,5	57,0	4,4
MS3100R36-**P	2-1/4-16UN-2A	15,8	3,9	85	22,2	60,8	49,2	63,5	4,4

*For socket inserts substitute S for P **Add contact arrangement number (see pages 7 – 14)

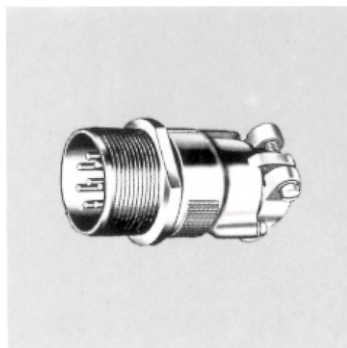

MS3101E/CA3101E MS3101F

MS3101E and F are cable connecting plugs without flange and coupling nut. MS3101E and F mate with 3106 and 3108 plugs.

For new programs order MS3101F only. If crimp version is required please order CA3101E...F80 or CA3101E...183

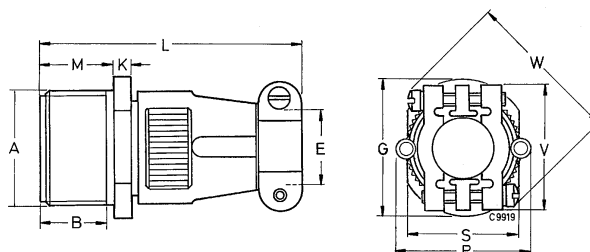

Order reference	A	B	E ¹⁾	G	K	L	M	S	V	W
Pin insert*	Thread	min.	max.	max.	±0,7	max.	+0,4	max.	max.	max.
MS3101E10SL-**P	5/8-2ENEF-2A	9,5	6,5	21,8	3,0	60	14,2	16,2	22,7	27,6
MS3101E12S-**P	3/4-20UNEF-2A	9,5	6,5	25,0	3,0	60	14,2	19,3	22,7	27,0
MS3101E14S-**P	7/8-20UNEF-2A	9,5	9,0	28,2	3,0	70	14,2	22,5	27,5	34,0
MS3101E16S-**P	1 -20U EF-2A	9,5	11,0	31,4	3,0	70	14,2	25,6	30,0	38,0
MS3101E12-**P	3/4-20UNEF-2A	15,8	6,5	25,0	3,0	70	19,0	19,3	22,7	27,0
MS3101E14-**P	7/8-20UNEF-2A	15,8	9,0	28,2	3,0	70	19,0	22,5	27,5	34,0
MS3101E16-**P	1 -20UNEF-2A	15,8	11,0	31,4	3,0	70	19,0	25,6	30,0	38,0
MS3101E18-**P	1-1/8-18NEF-2A	15,8	14,2	34,5	3,9	77	19,0	28,8	32,2	40,5
MS3101E20-**P	1-1/4-18NEF-2A	15,8	15,8	37,6	3,9	77	19,0	32,0	37,5	47,5
MS3101E22-**P	1-3/8-18NEF-2A	15,8	15,8	41,0	3,9	77	19,0	35,2	37,5	47,5
MS3101E24-**P	1-1/2-18NEF-2A	15,9	21,4	43,8	3,9	77	20,6	38,4	43,3	54,0
MS3101E28-**P	1-3/4-18NS-2A	15,8	21,4	50,5	3,9	85	20,6	44,8	43,3	54,0
MS3101E32-**P	2 -18NS-2A	15,8	26,7	57,0	3,9	85	22,2	51,2	51,7	64,5
MS3101E36-**P	2-1/4-16UN-2A	15,8	31,7	63,2	3,9	105	22,2	57,5	58,0	72,0

*For socket inserts substitute S for P **Add contact arrangement number (see pages 7 – 14) ¹⁾ maximum cable diameter

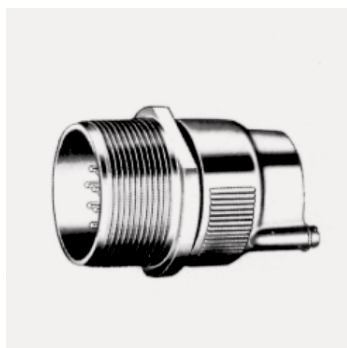

MS3101R / CA3101R

MS3101 cable connecting plugs without coupling nut feature a shorter and light-weight endbell than MS3101E and mate with 3106 and 3108 plugs.

If crimp version is required please order CA3101R..F80 or CA3101R...F183

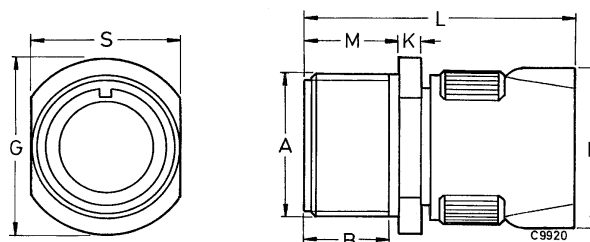

Order reference	A	B	G	K	L	M	P	S
Pin insert*	Thread	min.	max.	±0,7	max.	+0,4	max.	max
MS3101R10SL-**P	5/8-24NEF-2A	9,5	21,8	3,0	45	14,2	24,4	16,2
MS3101R12S-**P	3/4-20UNEF-2A	9,5	25,0	3,0	45	14,2	24,4	19,9
MS3101R14S-**P	7/8-20UNEF-2A	9,5	28,2	3,0	55	14,2	29,0	22,5
MS3101R16S-**P	1 -20UNEF-2A	9,5	31,4	3,0	55	14,1	31,5	25,6
MS3101R12-**P	3/4-0UNEF-2A	15,8	25,0	3,0	55	19,0	24,4	19,3
MS3101R14-**P	7/8-20UNEF-2A	15,8	28,2	3,0	55	19,0	29,0	22,5
MS3101R16-**P	1 -20UNEF-2A	15,8	31,4	3,0	55	19,0	31,5	25,6
MS3101R18-**P	1-1/8-18NEF-2A	15,8	34,5	3,9	60	19,0	36,6	28,8
MS3101R20-**P	1-1/4-18NEF-2A	15,8	37,6	3,9	60	19,0	39,7	32,0
MS3101R22-**P	1-3/8-18 EF-2A	15,8	41,0	3,0	60	19,0	39,7	35,2
MS3101R24-**P	1-1/2-18NEF-2A	15,8	43,8	3,9	60	20,6	47,4	38,4
MS3101R28-**P	1-3/4-18NS-2A	15,8	50,5	3,9	67	20,6	47,4	44,8
MS3101R32-**P	2 -18NS-2A	15,8	57,0	3,9	67	22,2	55,9	51,2
MS3101R36-**P	2-1/4-16UN-2A	15,8	63,2	3,9	85	22,2	60,8	57,5

*For socket inserts substitute S for P **Add contact arrangement number (see pages 7 – 14)

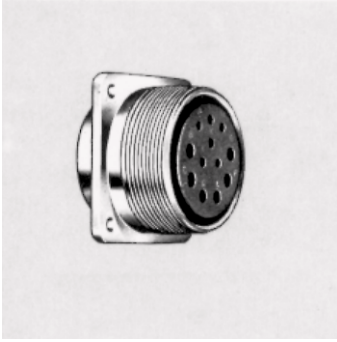

MS3102E MS3102R CA3102E

MS3102E and R are box mounting receptacles with square flange and mate with 3106 and 3108 plugs.

Shell size	Dimension X max for pin or socket (solder contacts only)			
	Contact size			
	16	12	8	4
10SL	13,6	-	-	-
12S, 14S, 16S	13,2	-	-	-
12	17,9	17,9	-	-
14	17,9	17,9	19,5	-
16	17,9	17,9	19,5	19,5
18	17,1	17,1	18,7	18,7
20, 22	17,1	17,1	18,7	18,7
24, 28	15,5	15,5	17,1	17,1
32, 36	13,9	13,9	15,5	15,5

Note: For new programs order MS3102R only. If crimp version is required please order CA3102R...F80 or CA3102R...F183.

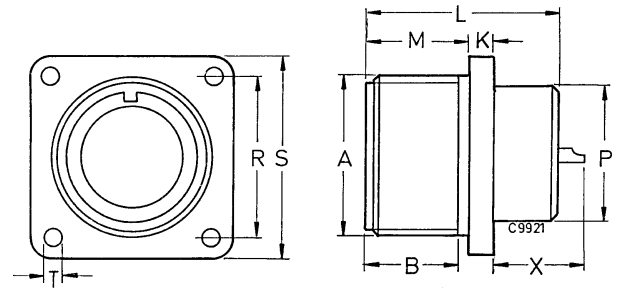

Order reference	A	B	K	L	M	P	R	S	T
Pin insert*	Thread	min.	±0,7	max.	+0,4	max.	±0,1	±0,3	+0,2 / -0,2
MS3102R10SL-**P	5/8-24NEF-2A	9,5	3,0	25,1	14,2	15,9	18,2	25,4	3,1
MS3102R12S-**P	3/4-20UNEF-2A	9,5	3,0	25,1	14,2	15,9	20,6	28,0	3,1
MS3102R14S-**P	7/8-20UNEF-2A	9,5	3,0	25,1	14,2	19,0	23,0	30,0	3,1
MS3102R16S-**P	1 -20U EF-2A	9,5	3,0	25,1	14,2	22,2	24,6	32,5	3,1
MS3102R16S-**P	1 -20UNEF-2A	9,5	3,0	25,1	14,2	22,2	24,6	32,5	3,1
MS3102R12-**P	3/4-20UNEF-2A	15,8	3,0	34,6	19,0	15,9	20,6	28,0	3,1
MS3102R14-**P	7/8-20UNEF-2A	15,8	3,0	34,6	19,0	19,0	23,0	30,0	3,1
MS3102R16-**P	1 -20UNEF2A	15,8	3,0	34,6	19,0	22,2	24,6	32,5	3,1
MS3102R18-**P	1-1/8-18NEF-2A	15,8	3,9	34,6	19,0	25,4	27,0	35,0	3,1
MS3102R20-**P	1-1/4-18NEF-2A	15,8	3,9	34,6	19,0	29,0	29,4	38,0	3,1
MS3102R22-**P	1-3/8-18NEF-2A	15,8	3,9	34,6	19,0	32,2	31,8	41,0	3,1
MS3102R24-**P	1-1/2-18NEF-2A	15,8	3,9	36,2	20,6	35,3	34,9	44,5	3,7
MS3102R28-**P	1-3/4-18NS-2A	15,8	3,9	36,2	20,6	41,2	39,7	50,8	3,7
MS3102R32-**P	2 -18NS-2A	15,8	3,9	37,8	22,2	47,6	44,5	57,0	4,4
MS3102R36-**P	2-1/4-16UN-2A	15,8	3,9	37,8	22,2	52,4	49,2	63,5	4,4

*For socket inserts substitute S for P **Add contact arrangement number (see pages 7 – 14)

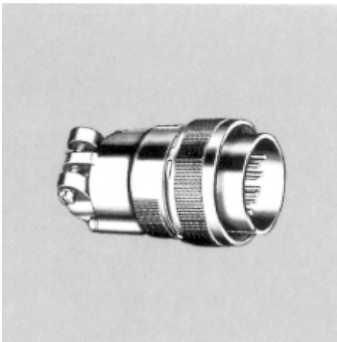

**MS3106E / CA3106E
MS3106F / CA06R**

MS3106E and F are straight plugs. They mate with 3100 and 3102 receptacles and 3101 plugs.

Note:
MS3106E corresponds to MS3106F, however, MS3106F has an O ring seal. For new programs order MS3101F only.

If crimp version is required please order CA3106E...F80 (without O ring), CA3106E...F183 (without O ring) or CA06R...F183 (with O ring).

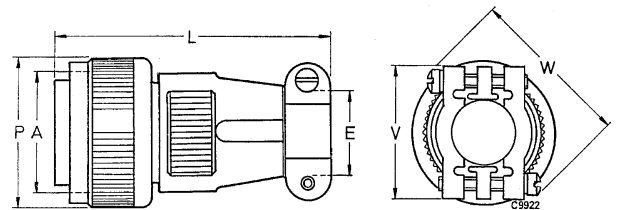

Order reference	A	E ¹⁾	L	P	V	W
Pin insert*	Thread	max.	max.	max.	max.	max.
MS3106E10SL-**P	5/8-24NEF-2B	6,5	55,0	24,1	22,7	27,0
MS3106E12S-**P	3/4-20UNEF-2B	6,5	55,0	25,8	22,7	27,0
MS3106E14S-**P	7/8-20UNEF-2B	9,0	60,0	28,8	27,5	34,0
MS3106E16-**P	1 -20UNEF-2B	11,0	60,0	31,8	30,0	38,0
MS3106E12-**P	3/4-20UNEF-2B	6,5	70,0	25,6	22,7	27,0
MS3106E14-**P	7/8-20UNEF-2B	9,0	70,0	28,8	27,5	34,0
MS3106E16-**P	1 -20UNEF-2B	11,0	70,0	31,8	30,0	38,8
MS3106E18-**P	1-1/8-18NEF-2B	14,2	75,0	34,1	32,2	40,5
MS3106E20-**P	1-1/4-18NEF-2B	15,8	75,0	37,4	37,5	47,5
MS3106E22-**P	1-3/8-18NEF-2B	15,8	75,0	40,5	37,5	47,0
MS3106E24-**P	1-1/2-18NEF-2B	21,4	75,0	43,8	43,3	54,0
MS3106E28-**P	1-3/4-18NS-2B	21,4	90,0	50,2	43,3	73,0
MS3106E32-**P	2 -18NS-2B	26,7	90,0	56,4	51,7	64,5
MS3106E36-**P	2-1/4-16UN-2B	31,7	100,0	62,8	58,0	73,0

*For socket inserts substitute S for P **Add contact arrangement number (see pages 7 – 14) ¹⁾ maximum cable diameter

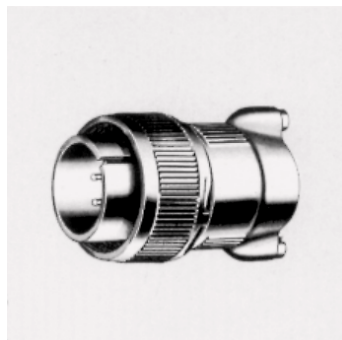

MS3106R / CA3106R

The MS3106R straight plug has a shorter lightweight endbell than MS3106E and F. It contains an O ring seal under the coupling nut. MS3106R plugs mate with 3100 and 3102 receptacles and 3101 plugs.

If crimp version is required please order CA3106R...F80 or CA3106R...183

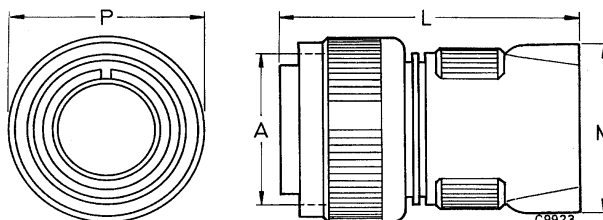

Order reference	A	L	M	P
Pin insert*	Thread	max.	max.	max.
MS3106R10SL-**P	5/8-24NEF-2B	40,0	24,4	24,1
MS3106R12S-**P	3/4-20UNEF-2B	40,0	24,4	25,8
MS3106R14S-**P	7/8-20UNEF-2B	45,0	29,0	28,8
MS3106R16S-**R	1 -20UNEF-2B	45,0	31,5	31,8
MS3106R12-**P	3/4-20U EF-2B	55,0	24,4	25,8
MS3106R14-**P	7/820UNEF2B	55,0	29,0	28,8
MS3106R16-**P	1 -20UNEF-2B	55,0	31,5	31,8
MS3106R18-**P	1-1/8-18NEF-2B	60,0	36,5	34,1
MS3106R20-**P	1-1/4-18 EF-2B	60,0	39,7	37,4
MS3106R22-**P	1-3/8-18NEF-2B	60,0	39,7	40,5
MS3106R24-**P	1-1/2-18 EF-2B	60,0	47,4	43,6
MS3106R28-**P	1-3/4-18NS-2B	70,0	47,4	50,2
MS3106R32-**P	2 -18NS-2B	70,0	55,9	56,4
MS3106R36-**P	2-1/4-16UN-2B	90,0	60,8	62,8

*For socket inserts substitute S for P

**Add contact arrangement number (see pages 7 – 14)



MS3108E / CA3108E MS3108R / CA3108R

MS3108R 90° right angle plugs mate with 3100 and 3102 receptacles and 3101 plugs. The 3108R has an O ring seal under the coupling nut. If no O ring is required the order reference is MS3108E.

Note: MS3108R is without cable clamp. If it is required with cable clamp please order the clamp separately.

If crimp version is required please order CA3108E...F80 (without O ring), CA3108E...F183 (without O ring) or CA3108R...F80 (with O ring), CA3108R...F183 (with O ring)

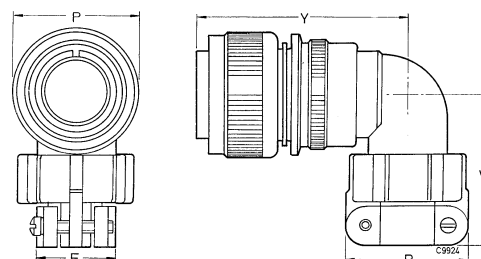

Order reference	A	E ¹⁾	P	R	V	Y
Pin insert*	Thread	max.	max.	max.	max.	max.
MS3108R10SL-**P	5/8-25NEF-2B	6,5	24,1	22,7	42,0	45,0
MS3108R12S-**P	3/4-20UNEF-2B	6,5	25,8	22,7	42,0	45,0
MS3108R14S-**P	7/8-20UNEF-2B	9,0	28,8	27,5	42,0	47,0
MS3108R16S-**R	1 -20UNEF-2B	11,0	31,8	30,0	45,0	48,0
MS3108R12-**P	3/4-20UNEF-2B	6,5	25,8	22,7	54,0	54,0
MS3108R14-**P	7/8-20UNEF-2B	9,0	28,8	27,5	35,7	55,0
MS3108R16-**P	1 -20UNEF-2B	11,0	31,8	30,0	45,0	57,0
MS3108R18-**P	1-1/8-18NEF-2B	14,2	34,1	32,2	53,0	58,0
MS3108R20-**P	1-1/4-18NEF-2B	15,8	37,4	37,5	53,0	61,0
MS3108R22-**P	1-3/8-18NEF-2B	15,8	40,5	37,5	53,0	61,0
MS3108R24-**P	1-1/2-18NEF-2B	21,4	43,8	43,3	58,0	66,0
MS3108R28-**P	1-3/4-18NS-2B	21,4	50,2	43,3	58,0	66,0
MS3108R32-**P	2 -18NS-2B	26,7	56,4	51,7	66,0	72,0
MS3108R36-**P	2-1/4-16UN-2B	31,7	62,8	58,0	69,0	75,0

*For socket inserts substitute S for P

**Add contact arrangement number (see pages 7 – 14) ¹⁾ maximum cable diameter



CA3101F

CA3101F is a cable connecting plug with threaded endbell. Crimp and solder versions are available (please indicate ...F80 or ...F183). CA3101F mate with 3106 and 3108 shell styles.

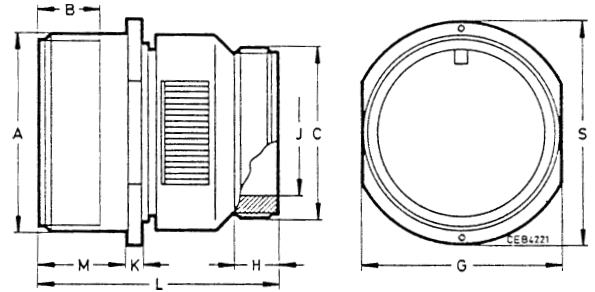

Order reference	A	C	B	G	H	J	K	L	M	S
Pin insert*	Thread	Thread	min.	max.	min.	min.	±0,7	max.	+0,4	max.
CA3101F10SL-**P	5/8-24NEF-2A	5/8-24NEF-2A	9,5	16,2	9,5	8,2	3,0	45,0	14,2	21,8
CA3101F12S-**P	3/4-20UNEF-2A	5/8-24NEF-2A	9,5	19,3	9,5	8,2	3,0	45,0	14,2	25,0
CA3101F14S-**P	7/8-20UNEF-2A	3/4-20UNEF-2A	9,5	22,5	9,5	11,1	3,0	45,0	14,2	28,2
CA3101F16S-**P	1 -20UNEF-2A	7/8-20UNEF-2A	9,5	25,6	9,5	14,3	3,0	45,0	14,2	31,4
CA3101F12-**P	3/4-20UNEF-2A	5/8-24NEF-2A	15,8	19,3	9,5	8,2	3,0	57,0	19,0	25,0
CA3101F14-**P	7/8-20UNEF-2A	3/4-20UNEF-2A	15,8	22,5	9,5	11,1	3,0	57,0	19,0	29,2
CA3101F16-**P	1 -20UNEF-2A	7/8-20UNEF-2A	15,8	25,6	9,5	14,3	3,0	57,0	19,0	31,4
CA3101F18-**P	1-1/8-18 EF-2A	1 -20UNEF-2A	15,8	28,8	9,5	16,7	3,9	57,0	19,0	34,5
CA3101F20-**P	1-1/4-18NEF-2A	1-3/16-18NEF-2A	15,8	32,0	9,5	19,8	3,9	57,0	19,0	37,6
CA3101F22-**P	1-3/8-18NEF-2A	1-3/16-18NEF-2A	15,8	35,2	9,5	19,8	3,9	57,0	19,0	41,0
CA3101F24-**P	1-1/2-18NEF-2A	1-7/16-18NEF-2A	15,8	38,4	9,5	25,4	3,9	57,0	20,6	43,8
CA3101F28-**P	1-3/4-18NS-2A	1-7/16-18NEF-2A	15,8	44,8	9,5	27,0	3,9	62,0	20,6	50,5
CA3101F32-**P	2 -18NS-2A	1-3/4-18NS-2A	15,8	51,2	11,0	32,5	3,9	62,0	22,2	57,9
CA3101F36-**P	2-1/4-16UN-2A	2 -18NS-2A	15,8	57,5	11,8	35,7	3,9	62,0	22,2	53,2

*For socket inserts substitute S for P

**Add contact arrangement number (see pages 7 – 14)



CA3106F

CA3106F is a straight plug with external thread, however, without cable clamp and O ring seal. Crimp and solder versions are available (please indicate ...F80 or ...F183). CA3106F mate with 3100, 3101 and 3102 shell styles.

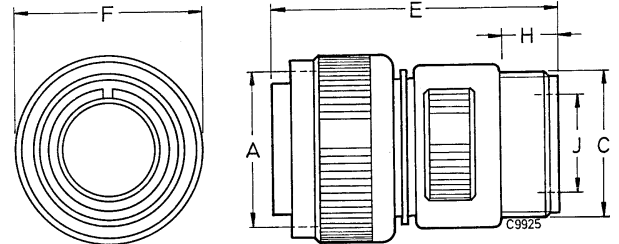

Order reference	A	C	E	F	H	J
Pin insert*	Thread	Thread	max.	max.	min.	min.
CA3106F10SL-**P	5/8-243 EF-2B	5/8-24 EF-2A	50,0	24,1	9,5	8,2
CA3106F12S-**P	3/4-20UNEF-2B	5/8-24NEF2A	50,0	25,8	9,5	8,2
CA3106F14S-**P	7/8-20UNEF-2B	3/4-20UNEF	50,0	28,8	9,5	11,1
CA3106F16S-**P	1 -20UNEF-2B	7/8-20UNEF-2A	50,0	31,8	9,5	14,3
CA3106F12-**P	3/4-20UNEF-2B	5/8-24NEF-2A	60,0	25,8	9,5	8,2
CA3106F14-**P	7/8-20UNEF-2B	3/4-20UNEF-2A	60,0	28,8	9,5	11,1
CA3106F16-**P	1 -20UNEF-2B	7/8-20UNEF-2A	60,0	31,8	9,5	14,3
CA3106F18-**P	1-1/8-18NEF2B	1 -20UNEF-2A	60,0	34,1	9,5	16,7
CA3106F20-**P	1-1/4-18NEF-2B	1-3/16-18NEF-2A	60,0	37,4	9,5	19,8
CA3106F22-**P	1-3/8-18NEF-2B	1-3/16-18NEF-2A	60,0	40,5	9,5	19,8
CA31.06F24-**P	1-1/2-18NEF-2B	1-7/16-18NEF-2A	65,0	43,8	9,5	25,4
CA3106F28-**P	1-3/4-18NS-2B	1-7/16-18NEF-2A	65,0	50,2	9,5	27,0
CA3106F32-**P	2 -18NS-2B	1-3/4-18NS-2A	65,0	56,4	11,0	32,5
CA3106F36-**P	2-1/4-16UN-2B	2 -18NS-2A	80,0	62,8	11,8	35,7

*For socket inserts substitute S for P

**Add contact arrangement number (see pages 7 – 14)



CA3106E-DN

CA3106E-DN is a straight plug with endbell for shrink boot adapters. Crimp and solder versions are available (please indicate ...F80 or ...F183). CA3106-DN mate with 3100, 3101 and 3102 shell styles.

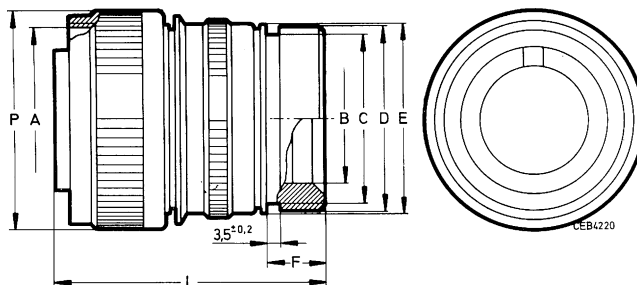

Order reference	A	B	C	D	E	F	L	P
Pin insert*	Thread	min.	max.	±0,2	±0,2	±0,5	max.	max.
CA3106E10SL--**P-DN	5/8-24NEF-2B	7,7	13,2	15,5	17,0	11,7	11,7	50,0
CA3106E12S--**P-DN	3/4-20UNEF-2B	7,9	13,2	15,5	17,8	11,8	58,8	25,6
CA3106E14S--**P-DN	7/8-20UNEF-2B	10,6	17,0	19,1	19,1	11,7	50,0	28,6
CA3106E16S--**P-DN	1 -20UNEF-2B	13,5	21,9	23,9	23,9	11,5	50,0	31,8
CA3106E12--**P-DN	3/4-20UNEF-2B	7,9	13,2	15,5	17,8	11,7	50,0	25,6
CA3106E14--**P-DN	7/8-20UNEF-2B	10,6	17,0	19,1	20,1	11,7	60,0	28,6
CA3106E16--**P-DN	1 -20UNEF-2B	13,5	21,9	23,9	23,5	11,5	60,0	31,8
CA3106E18--**P-DN	1-1/8-18NEF-2B	14,6	21,9	23,9	26,5	12,7	60,0	34,1
CA3106E20--**P-DN	1-1/4-18NEF-2B	18,5	26,6	29,6	30,2	12,7	65,0	37,3
CA3106E22--**P-DN	1-3/8-18NEF-2B	20,8	26,2	29,6	33,6	12,7	65,0	40,5
CA3106E24--**P-DN	1-1/2-16NEF-2B	24,6	34,5	37,8	36,1	12,7	65,0	43,8
CA3106E28--**P-DN	1-3/4-18NS-2B	27,0	34,5	37,8	41,4	12,7	65,0	50,0
CA3106E32--**P-DN	2 -18NS-2B	33,3	43,6	47,8	48,6	15,2	70,0	56,3
CA3106E36--**P-DN	2-1/4-16UN-2B	38,5	43,6	47,8	54,8	15,2	80,0	62,7

*For socket inserts substitute S for P **Add contact arrangement number (see pages 7 – 14)

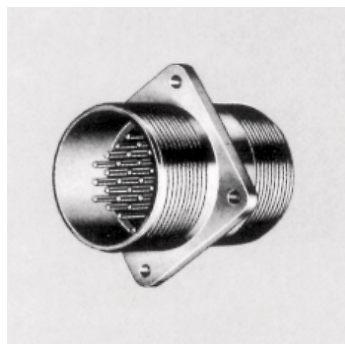

TBF

TBF is a through-bulkhead which mates with 3106 and 3108 plugs.

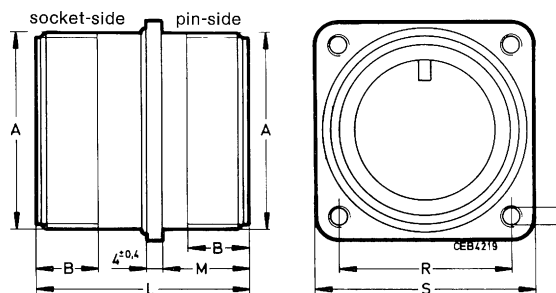

Order reference	A	B	L	M	R	S	T
Pin / Socket insert	Thread	min.	max.	+0,4	±0,1	±0,3	+0,2 / -0,1
TBF10SL--**PS	5/8-24NEF-2A	9,5	40,1	14,2	18,2	25,4	3,1
TBF12S--**PS	3/4-20UNEF-2A	9,5	40,1	14,2	20,6	28,0	3,1
TBF14S--**PS	7/8-20UNEF-2A	9,5	40,1	14,2	23,0	30,0	3,1
TBF16S--**PS	1 -20UNEF-2A	9,5	40,1	14,2	24,6	32,5	3,1
TBF12--**PS	3/4-20UNEF-2A	15,8	54,4	19,0	20,6	28,0	3,1
TBF14--**PS	7/8-20UNEF-2A	15,8	54,4	19,0	23,0	30,0	3,1
TBF16--**PS	1 -20UNEF-2A	15,8	54,4	19,0	24,6	32,5	3,1
TBF18--**PS	1-1/8-18NEF-2A	15,8	54,5	19,0	27,0	35,0	3,1
TBF20--**PS	1-1/4-18NEF-2A	15,8	54,5	19,0	29,4	38,0	3,1
TBF22--**PS	1-3/8-18NEF-2A	15,8	54,5	19,0	31,8	41,0	3,1
TBF24--**PS	1-1/2-18NEF-2A	15,8	54,5	20,5	34,9	44,5	3,7
TBF28--**PS	1-3/4-18NS-2A	15,8	54,5	20,6	39,7	50,8	3,7
TBF32--**PS	2 -18NS-2A	15,8	54,5	22,2	44,5	57,0	4,4
TBF36--**PS	2-1/4-16UN-2A	15,8	54,5	22,2	49,2	63,5	4,4

*For socket inserts substitute S for P **Add contact arrangement number (see pages 7 – 14)

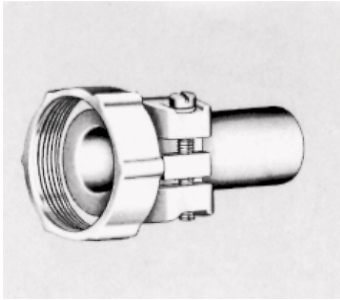

Cable Clamp with Bushing

Cable clamps are available with or without bushing. To order bushings, add "with bushing" to the part number.

For example:
MS3057-10A with bushing.

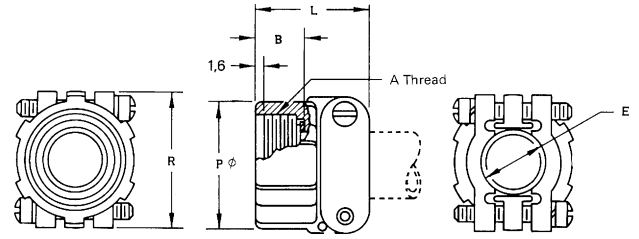

Order reference	Shell size	A Thread	B max.	E max.	L max.	R max.	Shell weight gr
MS3057-4A	10S, 12S, 12	5/8-24NEF-2B	10,5	7,9	20,8	22,5	13,2
MS3057-6A	14S, 14	3/4-20UNEF-2B	10,5	11,1	22,4	27,4	18,6
MS3057-8A	16S, 16	7/8-20UNEF-2B	10,5	14,2	24,0	29,8	23,6
MS3057-10A	18	1 -20UNEF-2B	10,5	15,8	24,0	32,2	27,3
MS3057-12A	20, 22	1-3/16-18NEF-2B	10,5	19,0	24,0	37,4	37,2
MS3057-16A	24, 26	1-7/16-18NEF-2B	10,5	23,7	26,4	43,5	56,3
MS3057-20A	32	1-3/4-18NS-2B	12,0	31,8	28,0	51,7	83,9
MS3057-24A	36	2 -18NS-2B	13,7	34,6	29,6	57,8	109,8

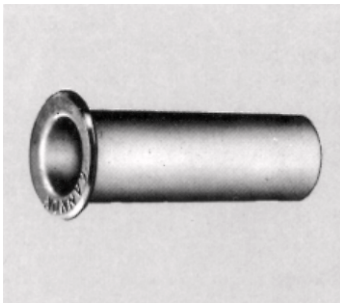

Telescoping Bushing

Telescoping gland bushings (used with cable clamp MS3057A) keep dirt, oil and moisture out of endbell. Taping or wrapping wires is eliminated since bushing protects wires going through clamp. Combinations of bushings may be used to decrease cable entry diameter to improve sealing.

Material is polychloroprene (MS).

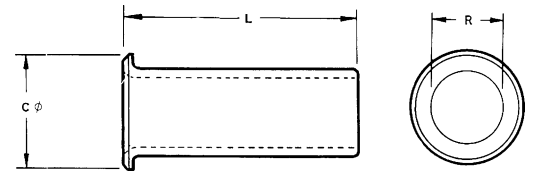

Order reference	Shell size	C max.	L max.	R -0,3	S -0,3
812-8552-000	10SL, 12, 12S	10,0	70,4	6,7	8,1
012-8554-000	14, 14S	12,8	67,4	9,2	11,0
012-0218-000	16, 16S	18,9	63,9	11,2	14,2
012-0219-000	18	22,1	60,6	14,4	15,8
012-0220-000	20, 22	27,0	57,4	16,0	18,9
012-8555-000	24, 28	27,0	57,4	16,78	21,3
012-8556-000	24, 28	33,5	54,4	21,6	23,7
012-8557-000	32	33,05	54,4	21,6	26,6
012-8558-000	32	40,5	51,4	26,9	31,6
012-8556-000	36	40,5	51,4	26,9	31,6
012-0223-000	36	47,0	48,4	31,9	34,8



Plastic protective caps

Material: Polyethylene
Colour: Red

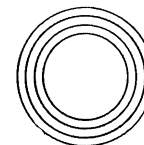
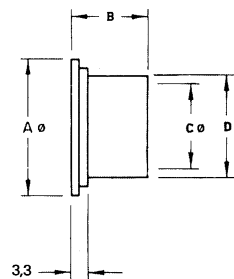

Order reference	MS3100 / 3101 / 3102	MS3106 / 3108	A	B	C	D
			max.	max.	$\pm 0,2$	max.
025-0460-000	10SL		21,5	17,8	15,2	16,9
025-0477-000		10 SL	20,4	12,5	14,0	15,7
025-0478-000		12S, 12	23,1	14,6	16,8	18,5
025-0462-000	12S, 12		24,7	17,8	18,5	20,2
025-0479-000		14S, 14	26,3	14,6	19,9	21,6
025-0463-000	14S, 14		27,8	17,8	21,6	23,3
025-0480-000		16S, 16	29,5	14,6	23,1	24,8
025-0498-000	16S, 16		31,5	17,8	25,1	26,8
025-0484-000		18	32,8	14,6	25,9	27,8
025-0507-000	18		34,7	17,8	28,2	30,1
025-0467-000		20	35,4	17,8	28,3	30,2
025-0468-000	20		38,1	17,8	31,8	33,4
025-0469-000	22		39,1	14,6	32,6	34,2
025-0486-000		22	41,4	17,8	34,5	36,5
025-0487-000		24	42,3	14,6	35,5	37,4
025-0510-000	24		44,2	17,8	37,8	39,8
025-0488-000		28	48,4	14,6	41,6	43,5
025-0501-000	28		50,4	17,8	43,9	45,9
025-0489-000		32	54,8	14,6	48,0	49,9
025-0502-000	32		57,0	17,8	50,3	52,2
025-0490-000		36	61,3	14,6	54,2	56,3
025-0503-000	36		63,4	17,8	56,6	58,6

Dust caps for mating side of plugs only.

Wire hole fillers

Where contacts are not used, the contact cavities are to be closed with wire hole fillers

Contact size AWG	metric	Wire size AWG	Part number	Colour
-	10	20	225-1000-000	red
16S/16	15S/15	16	225-0017-000	blue
12	25	12	225-0018-000	yellow
8	60/100	8	225-0019-000	white
4	160	4	225-8502-000	green
0	500	0	225-8503-000	black

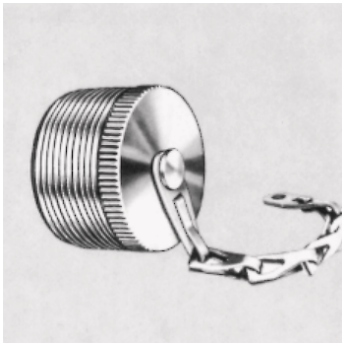

Metal protective caps

These externally threaded caps are used to protect 3106 and 3108 plugs. The material is aluminum alloy. The protective caps are furnished with a sash chain. They are also available with or without chain.

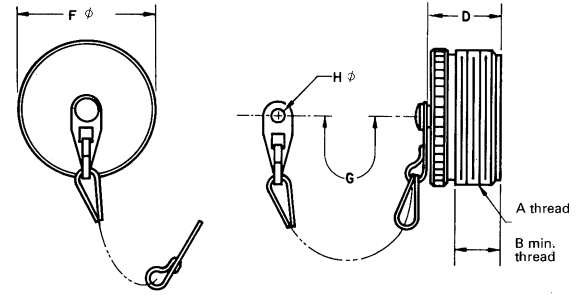

MS Order reference with chain	Cannon Order reference with chain	Cannon Order reference without chain	Shell size	A Thread	B min.	H +0,2	F max.	D max.	G max.	Shell weight with chain gr.	Shell weight without chain gr.
MS25042-10D	CA17530-5101	CA19741-10	10SL	5/8-24NEF-2A	7,7	3,9	16,7	16,3	107,0	6,4	3,2
MS25042-12D	CA17530-5102	CA19741-12	12S, 12	3/4-20U EF-2A	12,5	3,9	19,8	21,0	120,0	8,7	4,2
MS25042-14D	CA17530-5103	CA19741-14	14S, 14	7/8-20UNEF-2A	12,5	4,9	23,0	21,0	120,0	9,2	5,5
MS25042-16D	CA17530-5104	CA19741-16	16S, 16	1 -20UNEF-2A	12,5	3,9	26,2	21,0	120,0	10,0	6,0
MS25042-18D	CA17530-51005	CA19741-18	18	1-1/8-18NEF-2A	12,5	3,9	21,0	29,4	120,0	13,2	9,2
MS25042-20D	CA17530-5106	CA19741-20	20	1-1/4-18NEF-2A	12,5	4,7	32,5	21,0	124,0	15,5	12,0
MS25042-20D	CA17530.5106	CA19741-20	20	1-1/4-18NEF-2A	12,5	4,7	32,5	21,0	134,0	15,5	12,0
MS25042-22D	CA17530-5107	CA19741-22	22	1-3/8-18NEF-2A	12,5	4,7	35,7	21,0	134,0	16,5	13,3
MS25042-24D	CA17530-5108	CA19741-24	24	1-1/2-18NEF-2A	12,5	4,7	38,9	21,0	147,0	19,2	14,5
MS25042-28D	CA17530-5109	CA19741-28	28	1-3/4-18NS-2A	12,5	4,7	45,2	21,0	207,0	25,5	21,0
MS24042-32S	CA17530-5110	CA19741-32	32	2 -18NS-2A	12,5	5,5	51,6	21,0	207,0	31,0	28,0
MS25042-36D	CA17530-5111	CA19741-36	36	2-1/4-16UN-2A	12,5	5,5	57,9	21,0	207,0	36,05	33,0



Metal protective caps

These internally threaded caps are used to protect 3100, 3101 and 3102 receptacles. The material is aluminum alloy. The protective caps are furnished with or without a sash chain.

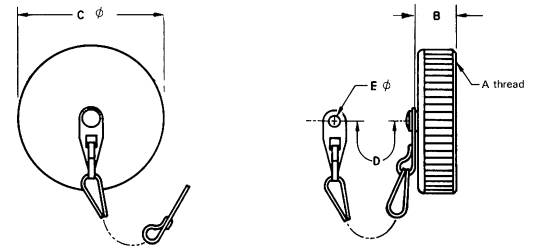

MS Order reference with chain	Cannon Order reference with chain	Cannon Order reference without chain	Shell size	A Thread	B max.	C max.	D max.	E +0,2	Shell weight with chain gr.	Shell weight without chain gr.
MS25043-10D	CA2209-5101	CA2322-2	10SL	5/8-24NEF-2B	11,7	20,2	107,0	3,9	5,5	4,1
MS25043-12D	CA2209-5102	CA2322-3	12S, 12	3/4-20UNEF-2B	11,7	23,4	120,0	3,9	7,7	5,0
MS25043-14D	CA2209-5103	CA2322-4	14S, 14	7/8-20UNEF-2B	11,7	26,6	120,0	3,0	8,2	5,5
MS25043-16D	CA2209-5104	CA2322-5	16S, 16	1 -20UNEF-2B	11,7	29,8	120,0	3,9	8,7	6,5
MS25043-18D	CA2209-5105	CA2322-6	18	1-1/8-18NEF-2B	11,7	32,9	120,0	3,9	9,6	7,7
MS25043-20D	CA2209-5106	CA2322-7	20	1-1/4-18NEF-2B	11,7	36,1	134,0	4,7	11,5	9,2
MS25043-22D	CA2209-5107	CA2322-8	22	1-3/8-18NEF-2B	11,7	39,4	134,0	4,7	12,7	10,5
MS25043-24D	CA2209-5108	CA2322-9	24	1-1/2-18NEF-2B	11,7	42,6	147,0	4,7	14,5	8,2
MS25043-28D	CA2209-5109	CA2322-10	28	1-3/4-18NS-2B	13,3	48,9	207,0	4,7	15,0	13,2
MS25043-32D	CA2209-5110	CA2322-11	32	2 -18NS-2B	13,3	55,3	207,0	5,5	26,5	21,0
MS25043-36D	CA2209-5111	CA2322-12	36	2-1/4-16UN-2B	13,3	61,6	207,0	5,5	33,2	27,5



Dummy Receptacle MS3105

The dummy receptacle holds 3106 or 3108 plugs when not in use.

Material: Aluminum alloy, finish is olive drab chromate over cadmium plate.

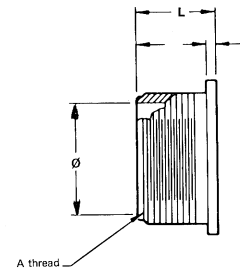
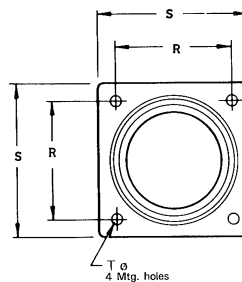

Order reference MS	for shell size	A Thread	K max.	L max.	N Æ max.	R ±0,1	S ±0,7	T +0,2 -0,1	Weight gr.
MS3105-10S	10SL	5/8-24NEF-2A	2,4	17,2	11,9	18,2	25,4	3,1	5,9
MS3105-12S	12S	3/4-20UNEF-2A	2,4	17,2	14,7	20,6	28,7	3,1	6,4
MS3105-14S	14S	7/8-20UNEF-2A	2,4	17,9	17,9	23,0	30,1	3,1	7,7
MS3105-16S	16S	1 -20UNEF-2A	2,4	17,2	21,0	24,6	32,5	3,1	9,1
MS3105-12	12	3/3-20UNEF-2A	2,4	22,0	14,7	20,6	28,7	3,1	7,3
MS31,05-14	14	7/8-20UNEF	2,4	22,0	17,9	23,0	30,0	3,1	9,1
MS3105-16-	16	1 -20UNEF-2A	2,4	22,0	21,0	24,6	32,5	3,1	10,0
MS3105-18	18	1-1/8-18UNEF-2A	3,0	22,5	24,2	27,0	34,9	3,1	14,1
MS3105-20	20	1-1/4-18UNEF-2A	3,0	22,5	27,4	29,4	38,0	3,1	15,0
MS3105-22	22	1-3/8-18UNEF-2A	3,0	22,5	30,6	31,8	41,3	3,1	16,8
MS3105-24	24	1-1/2-18UNEF-2A	3,0	24,1	33,7	34,9	44,4	3,7	21,8
MS3105-28	28	1-3/4-18UNS-2A	3,0	24,1	39,3	39,7	50,8	3,7	25,4
MS3105-32	32	2 -18UNS-2A	4,3	27,0	45,7	44,5	57,1	4,4	37,2
MS3105-36	36	2-1/4-16UN-2A	4,3	27,0	51,2	49,2	63,4	4,4	44,9

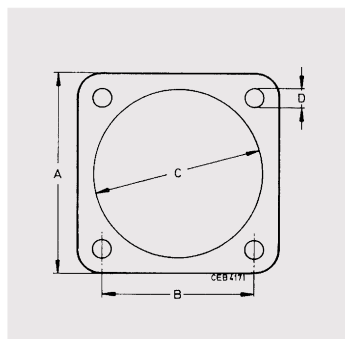

Sealing Gaskets

These sealing gaskets made of neoprene are used with flanged receptacles for sealing between the shell and the flange.

Order reference	MS Shell size	A ±0,1	B ±0,3	C ±0,2	D +0,2
075-8512-000	10SL	25,4	18,2	15,7	4,2
075-8513-000	12S, 12	28,0	20,6	18,9	4,2
075-8514-000	14S, 14	30,0	23,0	22,1	3,2
075-8515-000	16S, 16	32,5	24,6	25,3	4,2
075-8516-000	18	35,0	27,0	28,4	4,2
075-8517-000	20	38,0	29,4	31,6	4,2
075-8518-000	22	41,0	31,8	34,8	4,2
075-8519-000	24	44,5	34,9	38,0	4,2
075-8520-000	28	50,8	39,7	44,3	5,2
075-8521-000	32	57,0	44,5	50,7	5,2
075-8522-000	36	64,5	49,2	57,0	5,2

Contacts

Standard contacts and contacts with reduced termination size

Finish:

A36 - 5 µm silver plated (Standard)

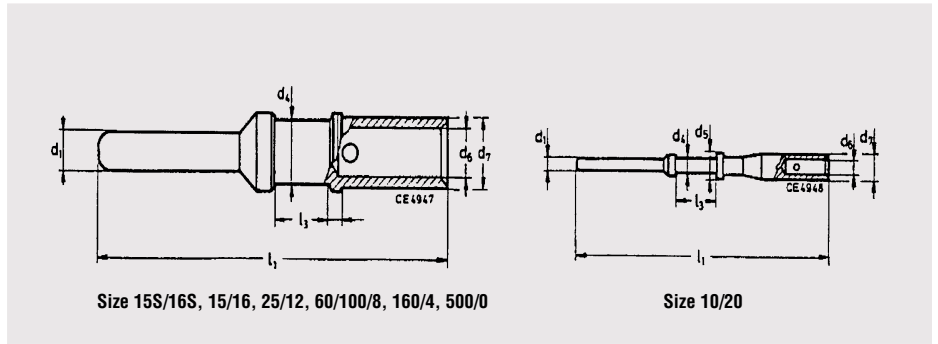

Pin Contacts

Dimensions are mm

Contact size	Termination size mm ²	AWG	Cannon Part number with finish		d1	d4	d6	d7	l1	l3	
			A36		+0,05				± 0,15	± 0,5	
			A176								
10/20	0,50 - 1,0	20/18	030-8585-006	030-8585-006	1,04	1,5 ^{-0,05}	1,5 ^{+0,05}	2,4 ^{-0,05}	28,4	4,75	
	0,2 - 0,4	24/22	030-8585-010	-	1,04	1,5 ^{-0,05}	1,5 ^{+0,05}	2,4 ^{-0,05}	28,4	4,75	
15S/16S	0,75 - 1,5	18 / 16	030-8586-000	030-8586-006	1,6	1,75 ^{-0,1}	1,75 ^{+0,08}	2,75 ^{-0,05}	27,4	3,85	
	0,3 - 0,6	22 / 20	030-8744-000	030-8744-006	1,6	1,75 ^{-0,1}	1,2 ^{+0,1}	2,75 ^{-0,05}	27,4	3,85	
	0,14 - 0,38	22 / 26	030-8586-010	-	1,6	1,75 ^{-0,1}	0,9 ^{+0,05}	2,75 ^{-0,05}	27,4	3,85	
15/16	0,75 - 1,5	18 / 16	030-8587-000	030-8587-006	1,6	1,75 ^{-0,1}	1,75 ^{+0,08}	2,75 ^{-0,05}	31,4	7,9	
	0,3 - 0,6	22 / 20	030-8659-000	030-8659-006	1,6	1,75 ^{-0,1}	1,2 ^{+0,1}	2,75 ^{-0,05}	31,4	7,9	
	0,14 - 0,38	22 / 26	030-8587-030	030-8687-036	1,6	1,75 ^{-0,1}	0,9 ^{+0,05}	2,75 ^{-0,05}	31,4	7,9	
25/12	2,0 - 3,0	14 / 12	030-8588-000	030-8588-006	2,4	3,3 ^{-0,15}	2,5 ^{+0,1}	3,8 ^{-0,1}	37,0	7,9	
	0,75 - 1,5	18 / 16	030-8588-010	030-8588-016	2,4	3,3 ^{-0,15}	1,75 ^{+0,08}	3,8 ^{-0,1}	37,0	7,9	
	4,0	-	030-8588-054	-	2,4	3,3 ^{-0,15}	2,8 ^{+0,1}	3,8 ^{-0,1}	37,0	7,9	
		-	-	030-8588-000	030-8588-006	2,4	3,3 ^{-0,15}	2,5 ^{+0,1}	3,8 ^{-0,1}	37,0	7,9
100/60/8	-	8	030-8612-000	030-8612-006	3,6	6,25 ^{-0,15}	4,55 ^{+0,1}	6,8 ^{-0,1}	39,6	6,35	
	6,0	10	030-8589-000	030-8589-006	3,6	6,25 ^{-0,15}	3,5 ^{+0,1}	6,8 ^{-0,1}	39,6	6,35	
	10,0	-	030-8590-000	030-8590-006	3,6	6,25 ^{-0,15}	4,8 ^{+0,1}	6,8 ^{-0,1}	39,6	6,35	
	2,0 - 3,0	14 / 12	030-8612-010	-	3,6	6,25 ^{-0,15}	2,5 ^{+0,05}	6,8 ^{-0,1}	39,6	6,35	
	4,0	-	030-8612-020	-	3,6	6,25 ^{-0,15}	2,8 ^{+0,1}	6,8 ^{-0,1}	39,6	6,35	
160/4	-	4	030-8613-000	030-8613-006	5,75	9,55 ^{-0,15}	7,10 ^{+0,15}	9,55 ^{-0,1}	39,6	6,35	
	16,00	-	030-8591-000	030-8591-006	5,75	9,55 ^{-0,15}	6,20 ^{+0,15}	9,55 ^{-0,1}	39,6	6,35	
	10,00	-	030-8591-020	-	5,75	9,55 ^{-0,15}	4,80 ^{+0,15}	9,55 ^{-0,1}	39,6	6,35	
	-	6	030-8613-010	-	5,75	9,55 ^{-0,15}	5,70 ^{+0,15}	9,55 ^{-0,1}	39,6	6,35	
500/0	-	0	030-8614-000	030-8614-006	9,10	13,55 ^{-0,15}	11,5 ^{+0,15}	14,35 ^{-0,1}	41,0	6,35	
	50,00	-	030-8592-000	030-8592-006	9,10	13,55 ^{-0,15}	10,7 ^{+0,15}	14,35 ^{-0,1}	41,0	6,35	
	25,00	4	030-8614-010	-	9,10	13,55 ^{-0,15}	7,6 ^{+0,15}	14,35 ^{-0,1}	41,0	6,35	
	35,00	2	030-8614-020	-	9,10	13,55 ^{-0,15}	9,1 ^{+0,15}	14,35 ^{-0,1}	41,0	6,35	
	16,00	-	-	030-8614-030	-	9,10	13,55 ^{-0,15}	6,2 ^{+0,15}	14,35 ^{-0,1}	41,0	6,35
		-	-	-	-	9,10	13,55 ^{-0,15}	6,2 ^{+0,15}	14,35 ^{-0,1}	41,0	6,35

Contacts

Standard contacts and contacts with reduced termination size

Finish:

A36 - 5 µm silver plated (Standard)

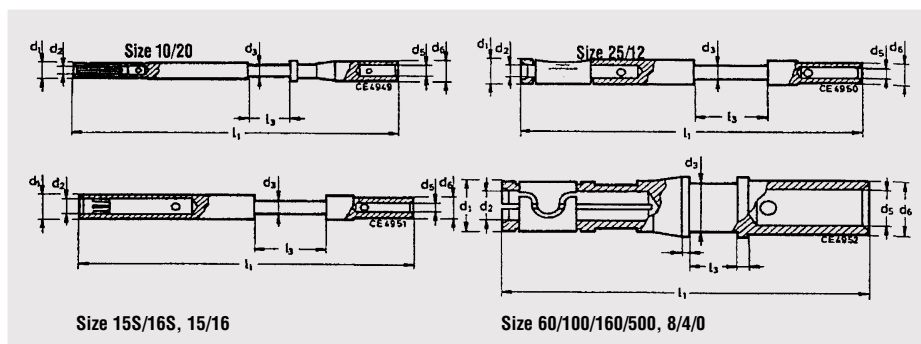

Socket contacts

Dimensions are mm

Contact size	Termination size mm ²	AWG	Cannon Part number with finish		d1	d2	d3	d5	d6	l1	l2
			A36	A176	+0,05				± 0,2	± 0,1	
10/20	0,5 - 1,0	20/18	031-8584-000	031-8584-006	2,0 ^{-0,1}	1,07	1,5 ^{+0,05}	1,5 ^{+0,05}	2,4 ^{-0,05}	36,8 ^{±0,3}	4,75
	0,2 - 0,4	24/22	031-8584-010	-	2,0 ^{-0,1}	1,07	1,5 ^{+0,05}	0,9 ^{+0,05}	2,4 ^{-0,05}	36,8 ^{±0,3}	4,75
15S/16S	0,75 - 1,5	18 / 16	031-8555-110	031-8555-115	3,2 ^{-0,15}	1,65	1,75 ^{-0,1}	1,75 ^{+0,08}	2,75 ^{-0,05}	29,1	3,9
	0,3 - 0,6	22 / 20	031-8688-110	031-8688-115	3,2 ^{-0,15}	1,65	1,75 ^{-0,1}	1,2 ^{+0,1}	2,75 ^{-0,05}	29,1	3,9
	0,14 - 0,38	22 / 26	031-8555-010	-	3,2 ^{-0,15}	1,65	1,75 ^{-0,1}	0,9 ^{+0,05}	2,75 ^{-0,05}	29,1	3,9
15/16	0,75 - 1,5	18 / 16	031-8556-110	031-8556-115	3,2 ^{-0,15}	1,65	1,75 ^{-0,1}	1,75 ^{+0,08}	2,75 ^{-0,05}	37,8	7,9
	0,3 - 0,6	22 / 20	031-8639-120	031-8639-115	3,2 ^{-0,15}	1,65	1,75 ^{-0,1}	1,2 ^{+0,1}	2,75 ^{-0,05}	37,8	7,9
	0,14 - 0,38	22 / 26	031-8556-130	-	3,2 ^{-0,15}	1,65	1,75 ^{-0,1}	0,9 ^{+0,05}	2,75 ^{-0,05}	37,8	7,9
25/12	2,0 - 3,0	14 / 12	031-8557-000	031-8557-006	4,8 ^{-0,1}	2,45	3,3 ^{-0,1}	2,5 ^{+0,1}	3,8 ^{-0,1}	37,0	7,9
	0,75 - 1,5	18 / 16	031-8557-020	031-8557-026	4,8 ^{-0,1}	2,45	3,3 ^{-0,1}	1,75 ^{+0,08}	3,8 ^{-0,1}	37,0	7,9
	4,0	-	031-8557-010	-	4,8 ^{-0,1}	2,45	3,3 ^{-0,1}	2,8 ^{+0,1}	3,8 ^{-0,1}	37,0	7,9
	0,3 - 0,6	22 / 20	031-8557-040	-	4,8 ^{-0,1}	2,45	3,3 ^{-0,1}	1,2 ^{+0,1}	3,8 ^{-0,1}	37,0	7,9
100/60/8	-	-	031-8519-000	031-8519-006	6,5 ^{-0,2}	3,65	6,25 ^{-0,2}	4,55 ^{+0,1}	6,8 ^{-0,1}	40,1	6,35
	6,0	10	031-8558-000	031-8558-006	6,5 ^{-0,2}	3,65	6,25 ^{-0,2}	3,5 ^{+0,1}	6,8 ^{-0,1}	40,1	6,35
	10,0	-	031-8559-000	031-8559-006	6,5 ^{-0,2}	3,65	6,25 ^{-0,2}	4,8 ^{+0,1}	6,8 ^{-0,1}	40,1	6,35
	2,0 - 3,0	14 / 12	31-8519-010	-	6,5 ^{-0,2}	3,65	6,25 ^{-0,2}	2,5 ^{+0,05}	6,8 ^{-0,1}	40,1	6,35
160/4	-	4	030-8520-000	031-8520-006	8,6 ^{-0,2}	5,8	9,55 ^{-0,2}	7,1 ^{+0,15}	9,55 ^{-0,1}	40,10	6,35
	16,00	-	031-8560-000	031-8560-006	8,6 ^{-0,2}	5,8	9,55 ^{-0,2}	6,2 ^{+0,15}	9,55 ^{-0,1}	40,10	6,35
	10,00	-	031-8560-020	-	8,6 ^{-0,2}	5,8	9,55 ^{-0,2}	4,8 ^{+0,15}	9,55 ^{-0,1}	40,10	6,35
	-	6	031-8520-010	-	8,6 ^{-0,2}	5,8	9,55 ^{-0,2}	5,7 ^{+0,15}	9,55 ^{-0,1}	40,10	6,35
500/0	-	0	031-8521-000	031-8521-006	13,2 ^{-0,2}	9,15	13,55 ^{-0,2}	11,5 ^{+0,15}	14,35 ^{-0,1}	41,6	6,35
	50,00	-	031-8561-000	-	13,2 ^{-0,2}	9,15	13,55 ^{-0,2}	10,7 ^{+0,15}	14,35 ^{-0,1}	41,6	6,35
	25,00	4	031-8521-010	-	13,2 ^{-0,2}	9,15	13,55 ^{-0,2}	7,6 ^{+0,15}	14,35 ^{-0,1}	41,6	6,35
	35,00	2	031-8561-020	-	13,2 ^{-0,2}	9,15	13,55 ^{-0,2}	9,1 ^{+0,15}	14,35 ^{-0,1}	41,6	6,35
	16,00	-	031-8521-030	-	13,2 ^{-0,2}	9,15	13,55 ^{-0,2}	6,2 ^{+0,15}	14,35 ^{-0,1}	41,6	6,35

Tooling

for **socket contacts** acc to VG95234 and Cannon contacts with reduced termination size

Contact size	Wire size mm ²	AWG	Hand crimp tools		Pneumatic crimp tools		Universal model	Crimp locator
			Type	Crimp locator	Standard model	Crimp locator		
10/20	0,2 – 1,0	18 – 24	M22520-1-01 (Order reference TH 452 995-0001-585)		612 871*	600 098	612 141*	600 325
15S/16S	0,2 – 1,0	16 – 22				600 083		TH 452
15/16	0,2 – 1,0	16 – 22				600 081		
25/12	0,2 – 1,0	12 – 18				600 099		
100/60/8	2 – 10	8 – 14	Hydraulic basic tool: - Crimp head 463200000.601 - High pressure hose, 2 m, 4604.0000.020		Hydraulic pumps: - Hand pump 4601.00000.330 - Foot pedal 4601.510000.330 - Electric pump, foot operated, 4609.00000.020		Crimp locators 317-8531-000 317-8531-001 317-8532-000 317-8532-001 317-8533-000 317-8533-001	
160/4	10 – 16	4 – 6						
500/0	14 – 50	0 – 4						

* bench mount with foot pedal 611 380

for **pin contacts** acc to VG95234 and Cannon contacts with reduced termination size

Contact size	Wire size mm ²	AWG	Hand crimp tools		Pneumatic crimp tools		Universal model	Crimp locator
			Type	Crimp locator	Standard model	Crimp locator		
10/20	10 – 2	8 – 14	M22520-1-01 (Order reference TH 452 995-0001-585)		612 871*	600 098	612 141*	600 325
15S/16S	0,2 – 1,0	16 – 22				600 082		TH 452
15/16	0,2 – 1,0	16 – 22				604 092		
25/12	0,2 – 1,0	12 – 18				600 099		
100/60/8	10 – 2	8 – 14	Hydraulic basic tool: - Crimp head 463200000.601 - High pressure hose, 2 m, 4604.0000.020		Hydraulic pumps: - Hand pump 4601.00000.330 - Foot pedal 4601.510000.330 - Electric pump, foot operated, 4609.00000.020		Crimp locators 317-8531-000 317-8531-001 317-8532-000 317-8532-001 317-8533-000 317-8533-001	
160/4	10 – 16	4 – 6						
500/0	14 – 50	0 – 4						

* bench mount with foot pedal 611 380

Crimp contacts

Connectors of series MS-E and MS-R are also available with crimp contacts for metric wire sizes. In order to wire, insert and extract these contacts the tools mentioned on this page are needed. All tools have to be ordered separately.

Ask for our detailed Wiring and Assembly Instruction.

Insertion tools

for contact insertion into insulator

Part No.	Order reference	Contact size
CIT-F80-16 or CIT-16	121 086-0097 or 121 086-3008	15S/15
CIT-F80-12 or CIT-12	121 086-0096 or 121 086-3007	25
CIT-F80-20 CIT-8	121086-0098 121086-0095	10 8/100
CIT-4 CIT-0	121086-0094 121086-0093	4/160 0/500

Extraction tools

for contact extraction from insulator

Part No.	Order reference	Contact size
CET-F80-16 CET-F80-12	121 086-0081 121 086-0080	15S/15/10 25
CET-8 CET-4	121086-0079 121086-0078	8/100 4/160
CET-0	121086-0077	0/500

Product Safety Information

THIS NOTE SHOULD BE READ IN CONJUNCTION WITH THE PRODUCT DATA SHEET/CATALOGUE. FAILURE TO OBSERVE THE ADVICE IN THIS INFORMATION SHEET AND THE OPERATING CONDITIONS SPECIFIED IN THE PRODUCT DATA SHEET/CATALOGUE COULD RESULT IN HAZARDOUS SITUATIONS.

1. MATERIAL CONTENT AND PHYSICAL FORM

Electrical connectors do not usually contain hazardous materials. They contain conducting and non-conducting materials and can be divided into two groups.

a) Printed circuit types and low cost audio types which employ all plastic insulators and casings.

b) Rugged, Fire Barrier and High Reliability types with metal casings and either natural rubber, synthetic rubber, plastic or glass insulating materials.

Contact materials vary with type of connector and also application and are usually manufactured from either copper, copper alloys, nickel, alumel, chromel or steel. In special applications, other alloys may be specified.

2. FIRE CHARACTERISTICS AND ELECTRIC SHOCK HAZARD

There is no fire hazard when the connector is correctly wired and used within the specified parameters. Incorrect wiring or assembly of the connector or careless use of metal tools or conductive fluids, or transit damage to any of the component parts may cause electric shock or burns. Live circuits must not be broken by separating mated connectors as this may cause arcing, ionisation and burning.

Heat dissipation is greater at maximum resistance in a circuit. Hot spots may occur when resistance is raised locally by damage, e.g. cracked or deformed contacts, broken strands of wire. Local overheating may also result from the use of the incorrect application tools or from poor quality soldering or slack screw terminals. Overheating may occur if the ratings in the Product Data Sheet/Catalogue are exceeded and can cause breakdown of insulation and hence electric shock.

If heating is allowed to continue it intensifies by further increasing the local resistance through loss of temper of spring contacts, formation of oxide film on contacts and wires, and leakage currents through carbonisation of insulation and tracking paths. Fire can then result in the presence of combustible materials and this may release noxious fumes. Overheating may not be visually apparent. Burns may result from touching overheated components.

3. HANDLING

Care must be taken to avoid damage to any component parts of electrical connectors during installation and use. Although there are normally no sharp edges, care must be taken when handling certain components to avoid injury to fingers.

Electrical connectors may be damaged in transit to the customers, and damage may result in creation of hazards. Products should therefore be examined prior to installation/use and rejected if found to be damaged.

4. DISPOSAL

Incineration of certain materials may release noxious or even toxic fumes.

5. APPLICATION

Connectors with exposed contacts should not be selected for use on the current supply side of an electrical circuit, because an electric shock could result from touching exposed contacts on an unmated connector. Voltages in excess of 30 V ac or 42.5 V dc are potentially hazardous and care should be taken to ensure that such voltages can not be transmitted in any way to exposed metal parts of the connector body. The connector and wiring should be checked, before making live, to have no damage to metal parts or insulators, no solder blobs, loose strands, conducting lubricants, swarf, or any other undesired conducting particles. Insulation resistance should be checked to make certain that no low resistance joints or spurious conducting path are existing between contacts and exposed metal parts of the connector body. Further the contact resistance of the connectors should be measured within the electrical circuit in order to identify high resistances which result in excessive connector heating.

Always use the correct application tools as specified in the Data Sheet/Catalogue.

Do not permit untrained personnel to wire, assemble or tramper with connectors.

For operation voltage please see appropriate national regulations.

IMPORTANT GENERAL INFORMATION.

1. Air and creepage paths/Operating voltage

The admissible operating voltages depend on the individual applications and the valid national and other applicable safety regulations.

For this reason the air and creepage path data are only reference values. Observe reduction of air and creepage paths due to PC board and/or harnessing.

2. Temperature

All information given are temperature limits. The operation temperature depends on the individual application.

3. Other important information

Cannon continuously endeavours to improve their products. Therefore, Cannon products may deviate from the description, technical data and shape as shown in this catalogue and data sheets.

4. Harnessing and Assembly Instructions

If applicable, our special harnessing and/or assembly instruction has to be adhered to. This is provided at request.

ITT Industries, Cannon manufactures the highest quality products available in the marketplace; however these products are intended to be used in accordance with the specifications in this catalog. Any use or application that deviates from stated operating specifications is not recommended and may be unsafe. No information and data contained in this catalog shall be construed to create any liability on the part of Cannon. Any new issue of this catalog shall automatically invalidate and supersede any and all previous issues. **A limited warranty applies to Cannon products. Except for obligations assumed by Cannon under this warranty, Cannon shall not be liable for any loss, damage, cost of repairs, incidental or consequential damages of any kind, whether or not based on express or implied warranty, contract, negligence or strict liability arising in connection with the design, manufacture, sale, use or repair of the products.** Product availability, prices and delivery dates are exclusively subject to our respective order confirmation form; the same applies to orders based on development samples delivered. This catalog is not to be construed as an offer. It is intended merely as an invitation to make an offer. By this publication, Cannon does not assume responsibility or any liability for any patent infringements or other rights of third parties which may result from its use. Reprinting this catalog is generally permitted, indicating the source. However, Cannon's prior consent must be obtained in all cases.

Cannon is a trademark of ITT Industries, Inc

Cannon Worldwide Facilities

Austria

Afrikanergasse 3
1020 Vienna
FAX: (1) 2160948 PH: (1) 2160947

Benelux

Rue Col. Bourg Str. 105A
1140 Brussels, Belgium
FAX: (02) 7269201 PH: (02) 726 75 94
NL
FAX: 31.35.691.8796 PH: 31.35.691.6855

China

No. 24, 2 Block
Taohuawu New District
Zhenjiang, Jiangsu
P.R.C.
FAX: 86 511 4428616 PH: 86 511 443 3399

Denmark

Park Allé 287 A
2605 Brøndby
FAX: 43 43 58 58 PH: 43 45 52 88

Finland

Virkatie 1
1510 Vantaa
FAX:+358 9 70039188 PH: +358 9 70039180

France

2, Ave Sablons Bouillants, B.P. 133
77109 Meaux
FAX: (1) 64 33 16 82 PH: (1) 60 24 51 51

Germany

Postfach 11 20, 71365 Weinstadt
Cannonstrasse 1, 71384 Weinstadt
FAX: (07151) 699217 P H: (07151) 699-0

Hong Kong

906 New World Office Building
West Wing, 20 Salisbury Road
Tsim Sha Tsui, Kowloon
FAX: (852) 2369-5651 PH: (852) 2732-2720

Italy

Via Panzeri 10
20123 Milano
FAX: (02) 8372036 PH: (02) 581801

Japan

5362-1, 5-chome, Hibarigaoka
Zama-shi, Kanagawa 228
FAX: 0462-57-1680 PH: 0462-57-2010

Korea

620, Changkang Bldg.
#22, Dohwa-dong, Mapo-ku
Seoul
FAX: (02) 717 7330 PH: (02) 702 7111

Spain

Parque Empresarial San Fernando
Edificio Italia 1ª Planta
28830 Madrid
FAX: (34) 91 656 15 83 PH: (34) 91 656 03 11

Sweden

Norr Mälärstrand 64
Jaktvarvet 1
11235 Stockholm
FAX: (46) 8 650 0072 PH: (46) 8 650 0071

Switzerland

Herzogenmühle 18
8304 Wallisellen
FAX: (01) 830-3104 PH: (01) 830-3888, 830-3613

United Kingdom

Jays Close, Viabes Estate
Basingstoke Hampshire RG22 4BA
FAX: (01256) 323356 PH: (01256) 311200

United States

666 E. Dyer Road
Santa Ana, CA 92705-5612
FAX: 714.628.2142 PH: 714.557.4700

INTERNET

<http://www.ittcannon.com>

Cannon



ITT Industries
Engineered for life

Mouser Electronics

Authorized Distributor

Click to View Pricing, Inventory, Delivery & Lifecycle Information:

ITT Cannon:

[MS3108R10SL-4S](#) [MS3108R10SL3S](#) [MS3108R10SL-3S](#) [MS3108R22-23S](#) [MS3108R12S-3S](#) [MS3108R10SL-3S-LC](#) [MS3108R20-8S-LC](#) [MS3108R22-14S](#) [MS3108R24-10S](#) [MS3108R20-16SW](#) [MS3108R18-1P](#) [MS3108R22-19S](#) [MS3108R20-7P](#) [MS3108R18-9P](#) [MS3108R28-16S](#) [MS3108R24-7S](#) [MS3108R24-12P](#) [MS3108R12S-3P](#) [MS3108R20-4S](#) [MS3108R20-2S](#) [MS3108R24-28S](#) [MS3108R36-10S](#) [MS3108R28-22S](#) [MS3108R12S-3PY](#) [MS3108R18-3S](#) [MS3108R18-1S](#) [MS3108R18-11P](#) [MS3108R20-29S](#) [MS3108R20-23P](#) [MS3108R28-10P](#) [MS3108R22-18S](#) [MS3108R18-11S](#) [MS3108R28-15S](#) [MS3108R14S-1P](#) [MS3108R14S-5P](#) [MS3108R24-12S](#) [MS3108R24-28P](#) [MS3108R24-22S](#) [MS3108R20-27P](#) [MS3108R14S-2P](#) [MS3108R24-22P](#) [MS3108R20-7S](#) [MS3108R14S-6P](#) [MS3108R24-7P](#) [MS3108R10SL-4P](#) [MS3108R16S-4S](#) [MS3108R18-10S](#) [MS3108R20-29P](#) [MS3108R28-16P](#) [MS3108R12S-4S](#) [MS3108R18-1S-LC](#) [MS3108R16S-8P](#) [MS3108R14S-6S](#) [MS3108R16S-1P](#) [MS3108R18-8P](#) [MS3108R14S-1S](#) [MS3108R22-22P](#) [MS3108R22-11S](#) [MS3108R18-8S](#) [MS3108R16-12S](#) [MS3108R22-14P](#) [MS3108R20-33P](#) [MS3108R16S-1S](#) [MS3108R10S-2S](#) [MS3108R24-10P](#) [MS3108R18-4S](#) [MS3108R14S-7P](#) [MS3108R32-15P](#) [MS3108R20-24S](#) [MS3108R24-7PW](#) [MS3108R24-7PZ](#) [MS3108R18-1P-LC](#) [MS3108R10SL-3P](#) [MS3108R22-14PW](#) [MS3108R22-12P](#) [MS3108R28-9S](#) [MS3108R22-7S](#) [MS3108R14S-2S-LC](#) [MS3108R28-12P](#) [MS3108R20-15S](#) [MS3108R24-12PW](#) [MS3108R14S-2S](#) [MS3108R22-2P](#) [MS3108R28-12S](#) [MS3108R14S-5S](#) [MS3108R20-33S](#) [MS3108R22-19P](#) [MS3108R20-15P](#) [MS3108R16S-4P](#) [MS3108R18-9S](#) [MS3108R28-11S](#) [MS3108R18-4P](#) [MS3108R20-27S](#) [MS3108R22-22S](#) [MS3108R20-29SW](#) [MS3108R14S-7S](#)