

# IRF6645

DirectFET™ Power MOSFET ②

Typical values (unless otherwise specified)

|                          |                       |                           |
|--------------------------|-----------------------|---------------------------|
| <b>V<sub>DS</sub></b>    | <b>V<sub>GS</sub></b> | <b>R<sub>DS(on)</sub></b> |
| 100V max                 | ±20V max              | 28mΩ @ 10V                |
| <b>Q<sub>g tot</sub></b> | <b>Q<sub>gd</sub></b> | <b>V<sub>gs(th)</sub></b> |
| 14nC                     | 4.8nC                 | 4.0V                      |

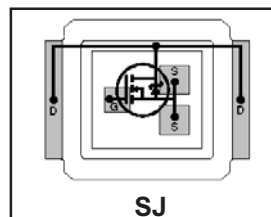

- RoHs Compliant Containing No Lead and Bromide ①
- Low Profile (<0.7 mm)
- Dual Sided Cooling Compatible ①
- Ultra Low Package Inductance
- Optimized for High Frequency Switching ①
- Ideal for High Performance Isolated Converter Primary Switch Socket
- Optimized for Synchronous Rectification
- Low Conduction Losses
- Compatible with existing Surface Mount Techniques ①

Applicable DirectFET Outline and Substrate Outline (see p.7,8 for details)①

|    |           |    |  |    |    |  |  |  |  |
|----|-----------|----|--|----|----|--|--|--|--|
| SH | <b>SJ</b> | SP |  | MZ | MN |  |  |  |  |
|----|-----------|----|--|----|----|--|--|--|--|

## Description

The IRF6645 combines the latest HEXFET® Power MOSFET Silicon technology with the advanced DirectFET™ packaging to achieve the lowest on-state resistance in a package that has the footprint of an Micro8 and only 0.7 mm profile. The DirectFET package is compatible with existing layout geometries used in power applications, PCB assembly equipment and vapor phase, infra-red or convection soldering techniques, when application note AN-1035 is followed regarding the manufacturing methods and processes. The DirectFET package allows dual sided cooling to maximize thermal transfer in power systems, improving previous best thermal resistance by 80%.

The IRF6645 is optimized for primary side bridge topologies in isolated DC-DC applications, for wide range universal input Telecom applications (36V - 75V), and for secondary side synchronous rectification in regulated DC-DC topologies. The reduced total losses in the device coupled with the high level of thermal performance enables high efficiency and low temperatures, which are key for system reliability improvements, and makes this device ideal for high performance isolated DC-DC converters.

## Absolute Maximum Ratings

|  | Parameter   | Max. | Units |
|--|---|------|-------|
| V <sub>DS</sub>                        | Drain-to-Source Voltage                           | 100  | V     |
| V <sub>GS</sub>                        | Gate-to-Source Voltage                            | ±20  |       |
| I <sub>D</sub> @ T <sub>A</sub> = 25°C | Continuous Drain Current, V <sub>GS</sub> @ 10V ③ | 5.7  | A     |
| I <sub>D</sub> @ T <sub>A</sub> = 70°C | Continuous Drain Current, V <sub>GS</sub> @ 10V ③ | 4.5  |       |
| I <sub>D</sub> @ T <sub>C</sub> = 25°C | Continuous Drain Current, V <sub>GS</sub> @ 10V ④ | 25   |       |
| I <sub>DM</sub>                        | Pulsed Drain Current ⑤                            | 45   |       |
| E <sub>AS</sub>                        | Single Pulse Avalanche Energy ⑥                   | 29   | mJ    |
| I <sub>AR</sub>                        | Avalanche Current ⑤                               | 3.4  | A     |

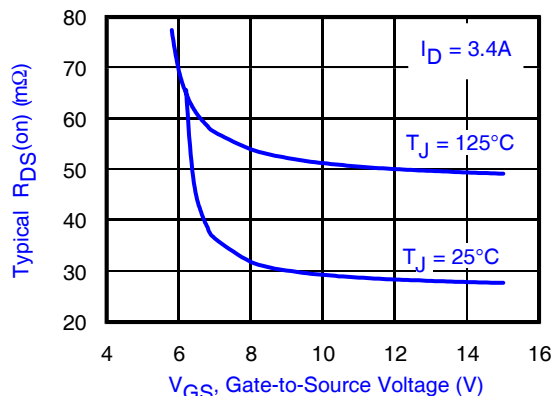

Fig 1. Typical On-Resistance vs. Gate Voltage

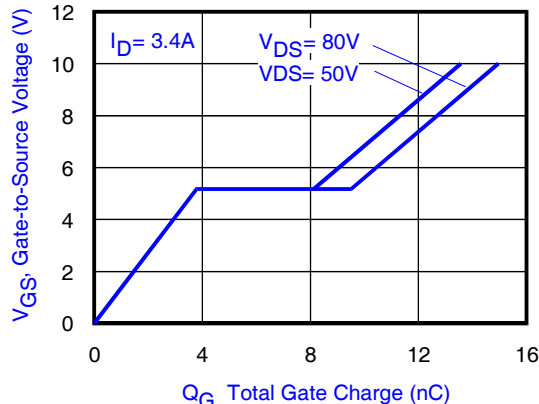

Fig 2. Typical Total Gate Charge vs. Gate-to-Source Voltage

### Notes:

- ① Click on this section to link to the appropriate technical paper.
- ② Click on this section to link to the DirectFET Website.
- ③ Surface mounted on 1 in. square Cu board, steady state.

- ④ T<sub>C</sub> measured with thermocouple mounted to top (Drain) of part.
- ⑤ Repetitive rating; pulse width limited by max. junction temperature.
- ⑥ Starting T<sub>J</sub> = 25°C, L = 5.0mH, R<sub>G</sub> = 25Ω, I<sub>AS</sub> = 3.4A.

## Electrical Characteristic @ $T_J = 25^\circ\text{C}$ (unless otherwise specified)

|                                | Parameter                            | Min. | Typ. | Max. | Units                | Conditions  |   |
|--------------------------------|--------------------------------------|------|------|------|----------------------|---|---|
| $BV_{DSS}$                     | Drain-to-Source Breakdown Voltage    | 100  | —    | —    | V                    | $V_{GS} = 0V, I_D = 250\mu A$                                       |   |
| $\Delta BV_{DSS}/\Delta T_J$   | Breakdown Voltage Temp. Coefficient  | —    | 0.12 | —    | V/ $^\circ\text{C}$  | Reference to $25^\circ\text{C}, I_D = 1\text{mA}$                   |   |
| $R_{DS(on)}$                   | Static Drain-to-Source On-Resistance | —    | 28   | 35   | m $\Omega$           | $V_{GS} = 10V, I_D = 5.7A$ ①  |   |
| $V_{GS(th)}$                   | Gate Threshold Voltage               | 3.0  | —    | 4.9  | V                    | $V_{DS} = V_{GS}, I_D = 50\mu A$                                    |   |
| $\Delta V_{GS(th)}/\Delta T_J$ | Gate Threshold Voltage Coefficient   | —    | -12  | —    | mV/ $^\circ\text{C}$ |   |   |
| $I_{DSS}$                      | Drain-to-Source Leakage Current      | —    | —    | 20   | $\mu A$              | $V_{DS} = 100V, V_{GS} = 0V$  |   |
|                                |                                      | —    | —    | 250  |                      | $V_{DS} = 80V, V_{GS} = 0V, T_J = 125^\circ\text{C}$                |   |
| $I_{GSS}$                      | Gate-to-Source Forward Leakage       | —    | —    | 100  | nA                   | $V_{GS} = 20V$  |   |
|                                | Gate-to-Source Reverse Leakage       | —    | —    | -100 |                      | $V_{GS} = -20V$   |   |
| gfs                            | Forward Transconductance             | 7.4  | —    | —    | S                    | $V_{DS} = 10V, I_D = 3.4A$  |   |
| $Q_g$                          | Total Gate Charge                    | —    | 14   | 20   | nC                   | $V_{DS} = 50V$<br>$V_{GS} = 10V$<br>$I_D = 3.4A$<br>See Fig. 15     |   |
| $Q_{gs1}$                      | Pre-Vth Gate-to-Source Charge        | —    | 3.1  | —    |                      |   |   |
| $Q_{gs2}$                      | Post-Vth Gate-to-Source Charge       | —    | 0.8  | —    |                      |   |   |
| $Q_{gd}$                       | Gate-to-Drain Charge                 | —    | 4.8  | 7.2  |                      |   |   |
| $Q_{godr}$                     | Gate Charge Overdrive                | —    | 5.3  | —    |                      |   |   |
| $Q_{sw}$                       | Switch Charge ( $Q_{gs2} + Q_{gd}$ ) | —    | 5.6  | —    |                      |   |   |
| $Q_{oss}$                      | Output Charge                        | —    | 7.2  | —    | nC                   | $V_{DS} = 16V, V_{GS} = 0V$   |   |
| $R_G$                          | Gate Resistance                      | —    | 1.0  | —    | $\Omega$             |   |   |
| $t_{d(on)}$                    | Turn-On Delay Time                   | —    | 9.2  | —    | ns                   | $V_{DD} = 50V, V_{GS} = 10V$ ①<br>$I_D = 3.4A$<br>$R_G = 6.2\Omega$ |   |
| $t_r$                          | Rise Time                            | —    | 5.0  | —    |                      |   |   |
| $t_{d(off)}$                   | Turn-Off Delay Time                  | —    | 18   | —    |                      |   |   |
| $t_f$                          | Fall Time                            | —    | 5.1  | —    |                      |   |   |
| $C_{iss}$                      | Input Capacitance                    | —    | 890  | —    | pF                   | $V_{GS} = 0V$<br>$V_{DS} = 25V$<br>$f = 1.0\text{MHz}$              |   |
| $C_{oss}$                      | Output Capacitance                   | —    | 180  | —    |                      |   |   |
| $C_{rss}$                      | Reverse Transfer Capacitance         | —    | 40   | —    |                      |   |   |
| $C_{oss}$                      | Output Capacitance                   | —    | 870  | —    |                      |   | $V_{GS} = 0V, V_{DS} = 1.0V, f = 1.0\text{MHz}$ |
| $C_{oss}$                      | Output Capacitance                   | —    | 100  | —    |                      |   | $V_{GS} = 0V, V_{DS} = 80V, f = 1.0\text{MHz}$  |

## Diode Characteristics

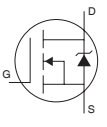
|          | Parameter                                 | Min. | Typ. | Max. | Units | Conditions   |
|----------|---|------|------|------|-------|--|
| $I_S$    | Continuous Source Current<br>(Body Diode) | —    | —    | 25   | A     | MOSFET symbol showing the integral reverse p-n junction diode.  |
| $I_{SM}$ | Pulsed Source Current<br>(Body Diode) ②   | —    | —    | 45   |       |  |
| $V_{SD}$ | Diode Forward Voltage                     | —    | —    | 1.3  | V     | $T_J = 25^\circ\text{C}, I_S = 3.4A, V_{GS} = 0V$ ①  |
| $t_{rr}$ | Reverse Recovery Time                     | —    | 31   | 47   | ns    | $T_J = 25^\circ\text{C}, I_F = 3.4A, V_{DD} = 50V$   |
| $Q_{rr}$ | Reverse Recovery Charge                   | —    | 40   | 60   | nC    | $di/dt = 100A/\mu s$ ①   |

### Notes:

① Pulse width  $\leq 400\mu s$ ; duty cycle  $\leq 2\%$ .

② Repetitive rating; pulse width limited by max. junction temperature.

**Absolute Maximum Ratings**

|                                | Parameter                  | Max.         | Units |
|--------------------------------|----------------------------|--------------|-------|
| $P_D @ T_A = 25^\circ\text{C}$ | Power Dissipation ①        | 3.0          | W     |
| $P_D @ T_A = 70^\circ\text{C}$ | Power Dissipation ①        | 1.4          |       |
| $P_D @ T_C = 25^\circ\text{C}$ | Power Dissipation ④        | 42           |       |
| $T_P$                          | Peak Soldering Temperature | 270          | °C    |
| $T_J$                          | Operating Junction and     | -40 to + 150 |       |
| $T_{STG}$                      | Storage Temperature Range  |              |       |

**Thermal Resistance**

|                    | Parameter               | Typ. | Max. | Units |
|--------------------|-------------------------|------|------|-------|
| $R_{\theta JA}$    | Junction-to-Ambient ①⑤  | —    | 58   | °C/W  |
| $R_{\theta JA}$    | Junction-to-Ambient ②⑤  | 12.5 | —    |       |
| $R_{\theta JA}$    | Junction-to-Ambient ③⑤  | 20   | —    |       |
| $R_{\theta JC}$    | Junction-to-Case ④⑤     | —    | 3.0  |       |
| $R_{\theta J-PCB}$ | Junction-to-PCB Mounted | 1.0  | —    |       |

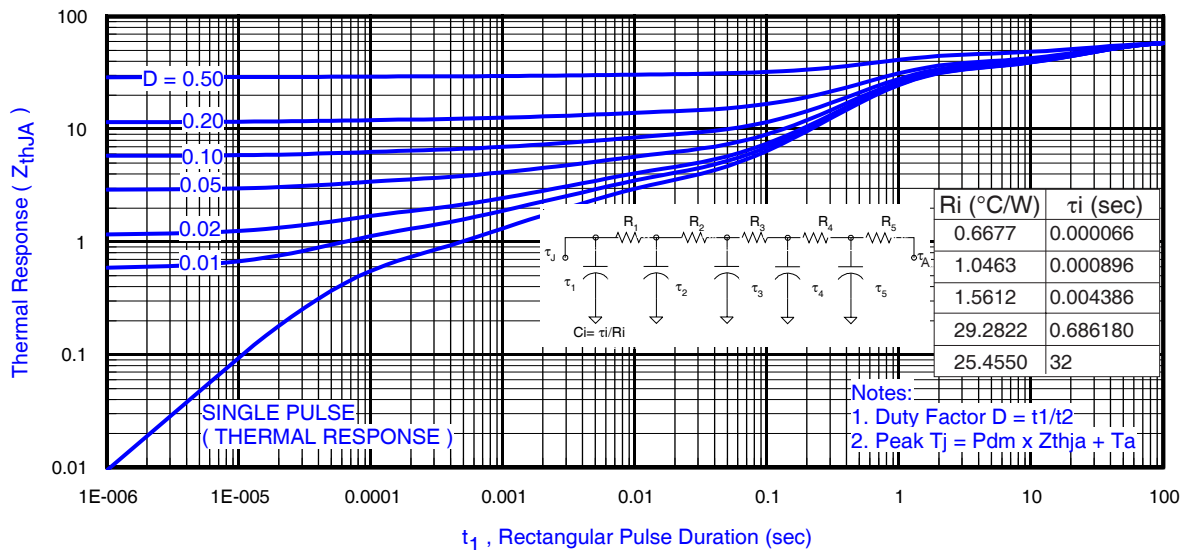

**Fig 3. Maximum Effective Transient Thermal Impedance, Junction-to-Ambient ①**

**Notes:**

- ① Surface mounted on 1 in. square Cu, steady state.
- ② Used double sided cooling, mounting pad.
- ③ Mounted on minimum footprint full size board with metalized back and with small clip heatsink.
- ④  $T_C$  measured with thermocouple incontact with top (Drain) of part.
- ⑤  $R_\theta$  is measured at  $T_J$  of approximately  $90^\circ\text{C}$ .

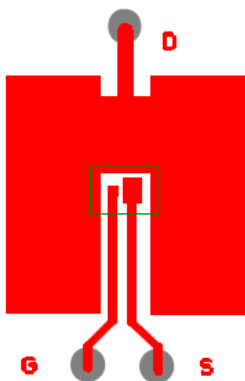

① Surface mounted on 1 in. square Cu board (still air).

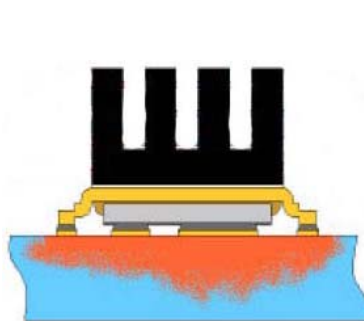

③ Mounted to a PCB with small clip heatsink (still air)

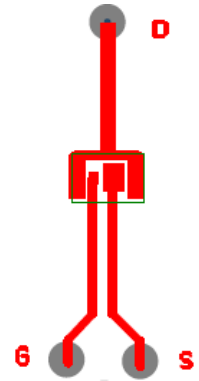

③ Mounted on minimum footprint full size board with metalized back and with small clip heatsink (still air)

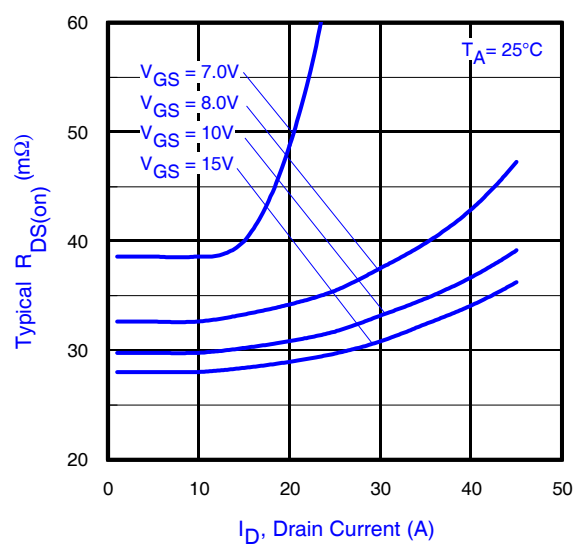
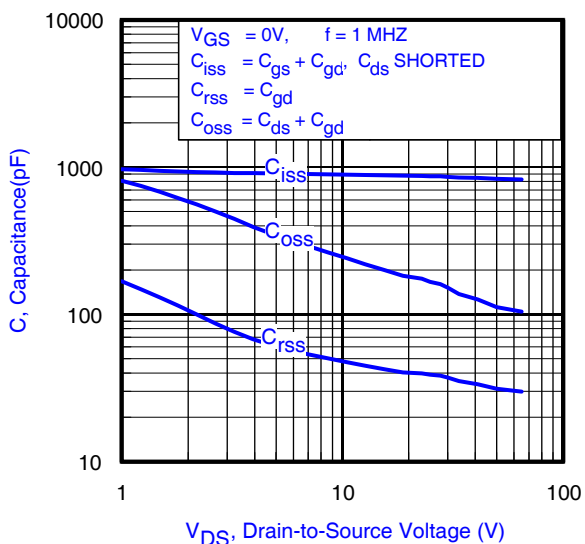
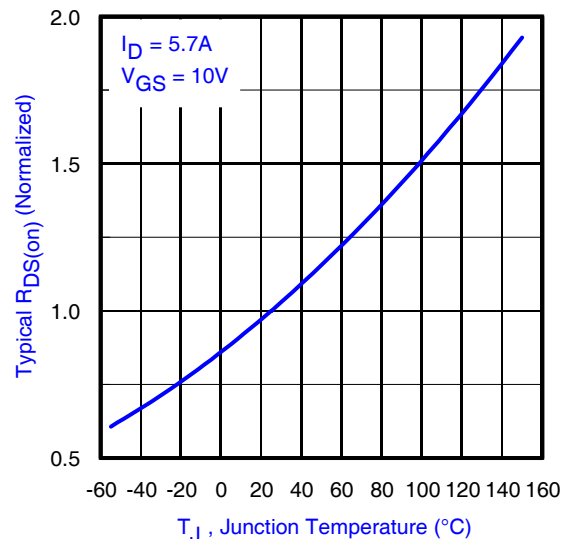
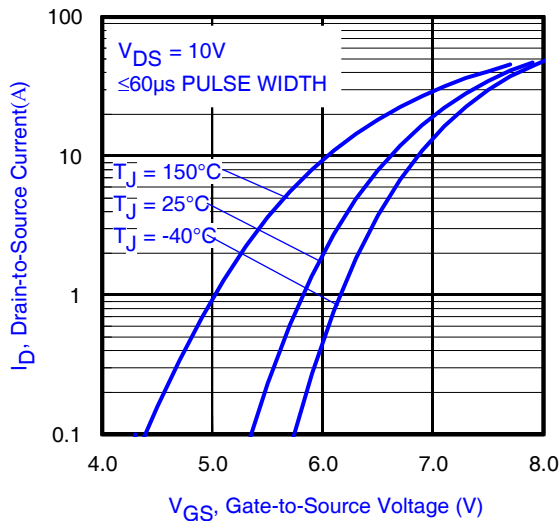
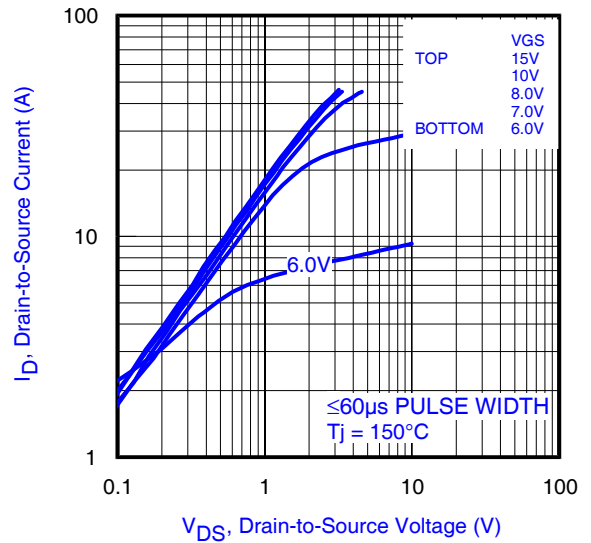
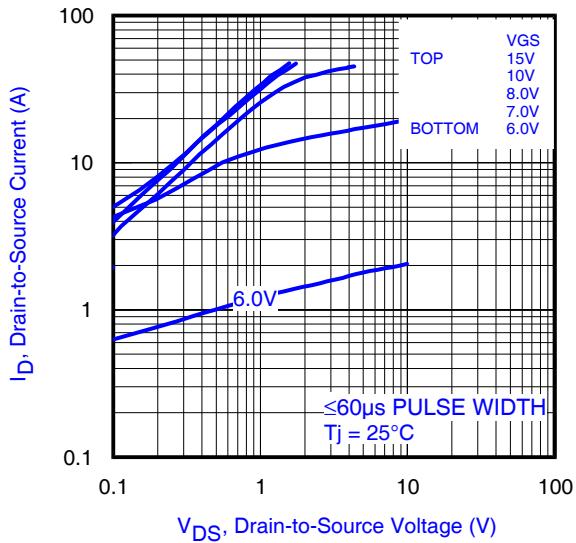

Fig 8. Typical Capacitance vs. Drain-to-Source Voltage

Fig 9. Typical On-Resistance vs. Drain Current

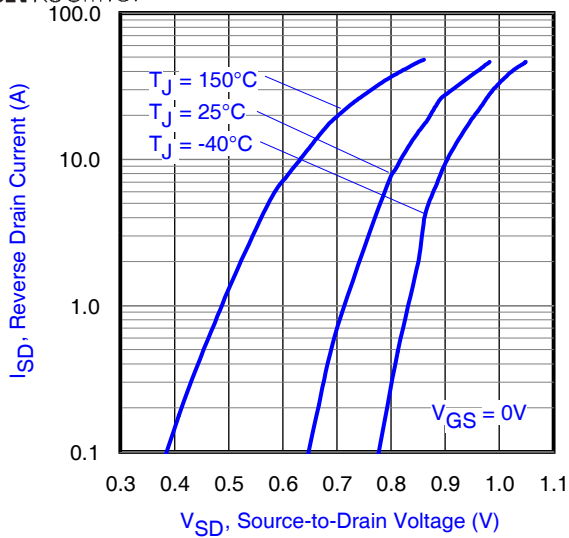

Fig 10. Typical Source-Drain Diode Forward Voltage

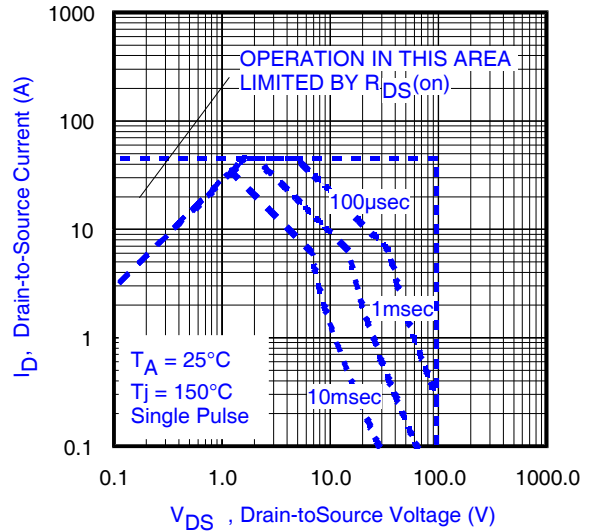

Fig11. Maximum Safe Operating Area

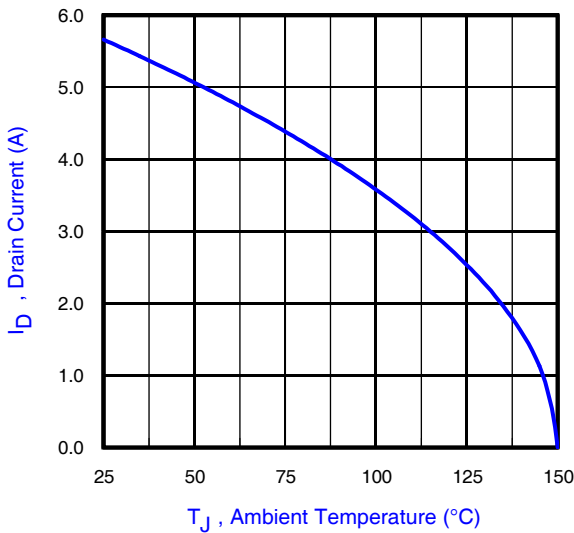

Fig 12. Maximum Drain Current vs. Ambient Temperature

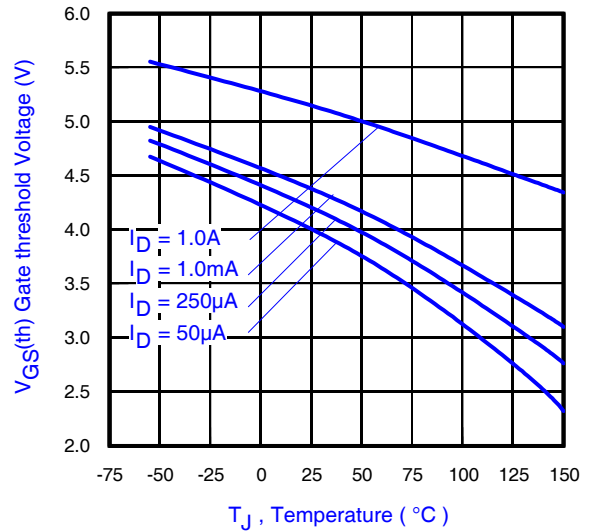

Fig 13. Typical Threshold Voltage vs. Junction Temperature

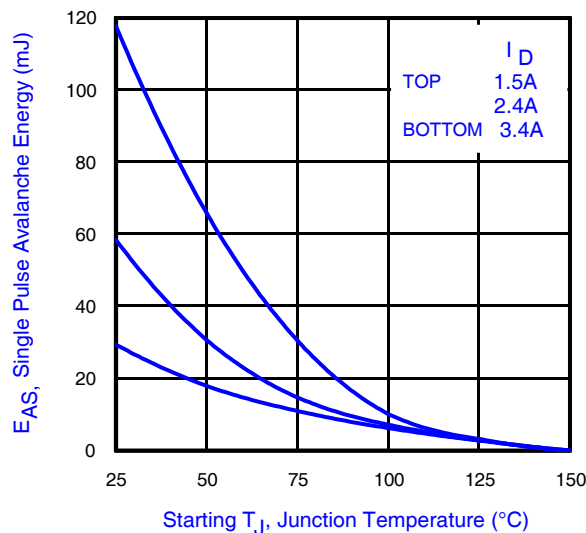
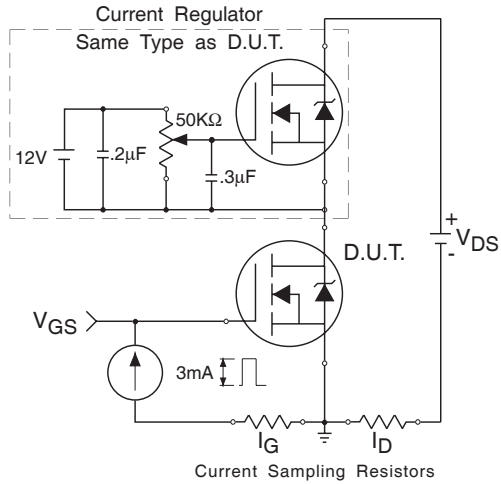
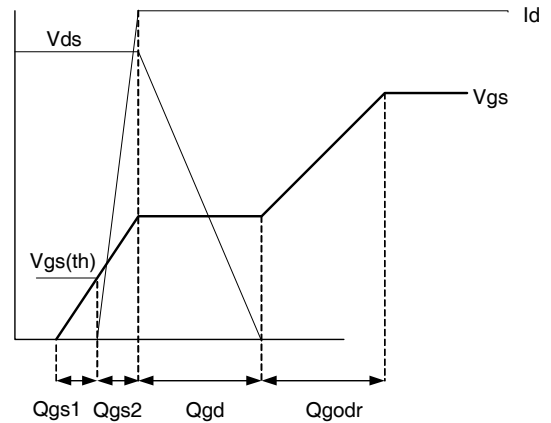

Fig 14. Maximum Avalanche Energy vs. Drain Current



**Fig 15a.** Gate Charge Test Circuit



**Fig 15b.** Gate Charge Waveform

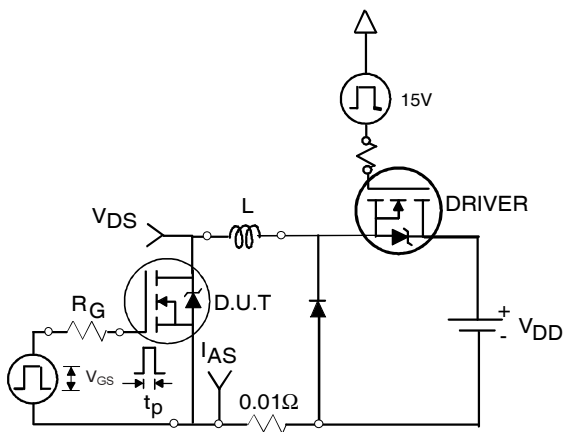

**Fig 16b.** Unclamped Inductive Test Circuit



**Fig 16c.** Unclamped Inductive Waveforms

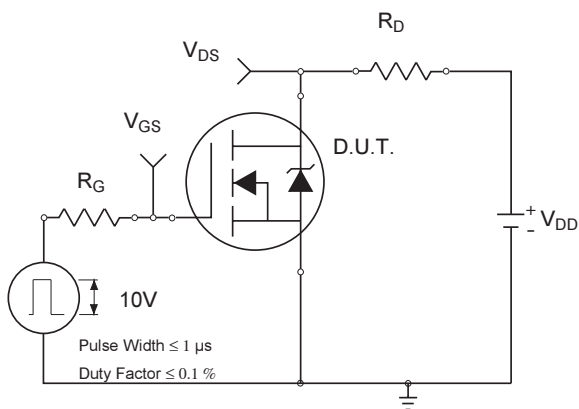

**Fig 17a.** Switching Time Test Circuit

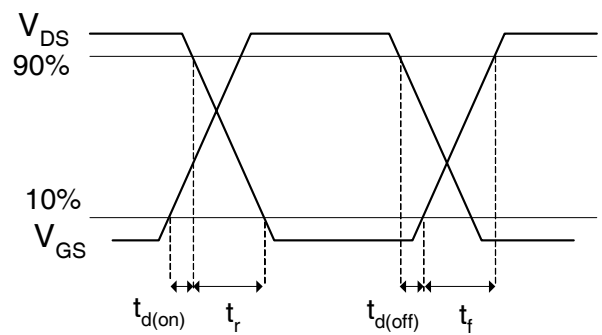

**Fig 17b.** Switching Time Waveforms

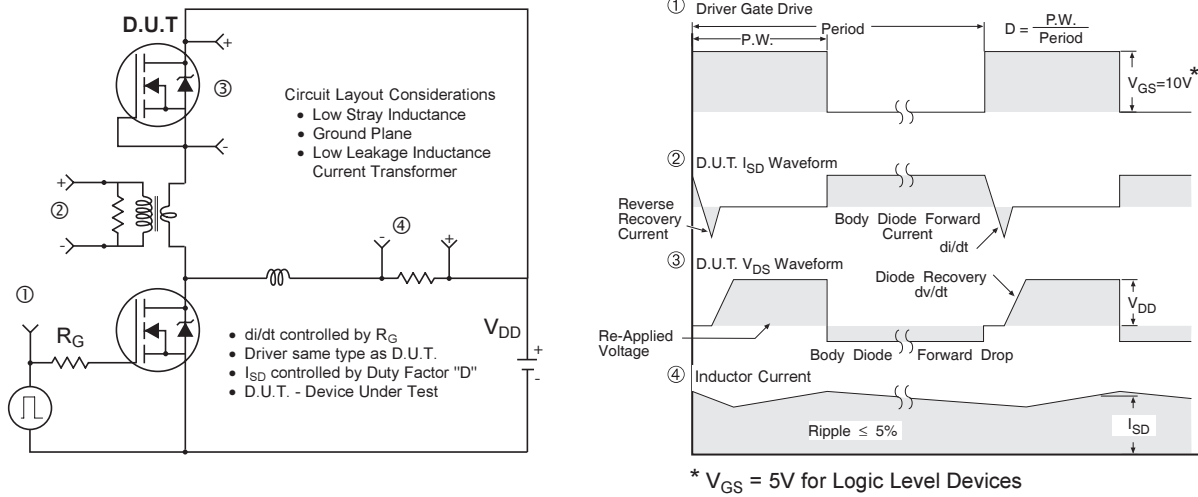
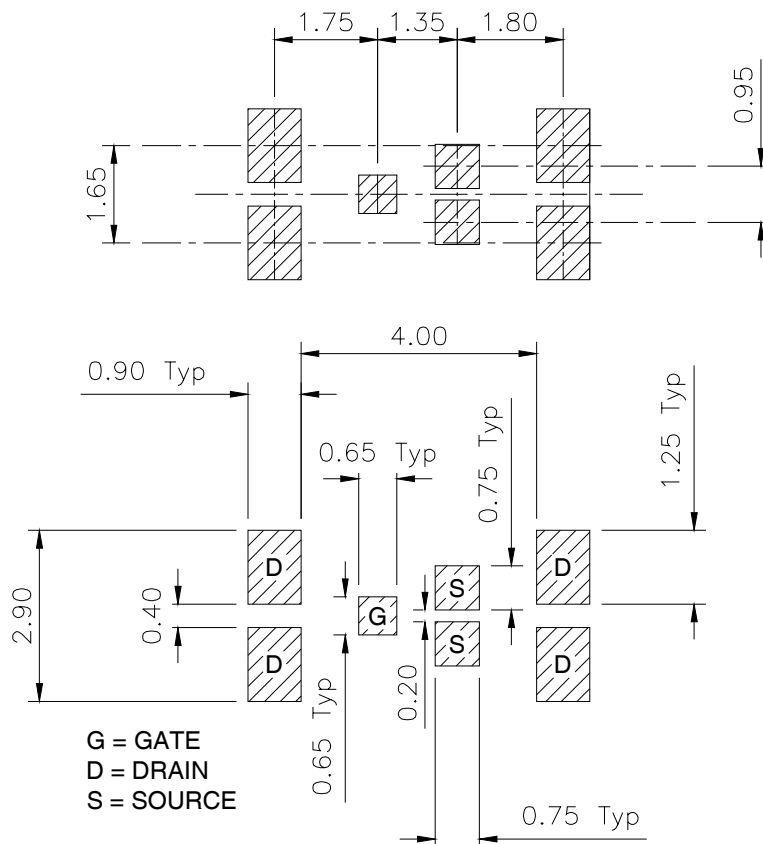

**Fig 18.** Diode Reverse Recovery Test Circuit for N-Channel HEXFET® Power MOSFETs

### DirectFET™ Substrate and PCB Layout, SJ Outline (Small Size Can, J-Designation).

Please see DirectFET application note AN-1035 for all details regarding the assembly of DirectFET.

This includes all recommendations for stencil and substrate designs.



# IRF6645

## DirectFET™ Outline Dimension, SJ Outline (Small Size Can, J-Designation).

Please see DirectFET application note AN-1035 for all details regarding the assembly of DirectFET.

This includes all recommendations for stencil and substrate designs.

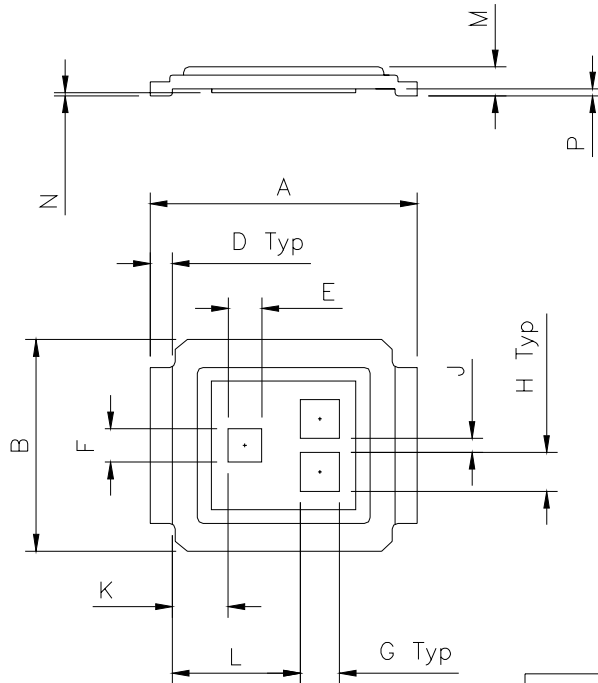

| CODE | METRIC |      | IMPERIAL |       |
|------|--------|------|----------|-------|
|      | MIN    | MAX  | MIN      | MAX   |
| A    | 4.75   | 4.85 | 0.187    | 0.191 |
| B    | 3.70   | 3.95 | 0.146    | 0.156 |
| C    | 2.75   | 2.85 | 0.108    | 0.112 |
| D    | 0.35   | 0.45 | 0.014    | 0.018 |
| E    | 0.58   | 0.62 | 0.023    | 0.024 |
| F    | 0.58   | 0.62 | 0.023    | 0.024 |
| G    | 0.68   | 0.72 | 0.027    | 0.028 |
| H    | 0.68   | 0.72 | 0.027    | 0.028 |
| K    | 0.98   | 1.02 | 0.039    | 0.040 |
| L    | 2.28   | 2.32 | 0.090    | 0.091 |
| M    | 0.48   | 0.58 | 0.019    | 0.023 |
| N    | 0.03   | 0.08 | 0.001    | 0.003 |
| P    | 0.08   | 0.17 | 0.003    | 0.007 |

## DirectFET™ Part Marking

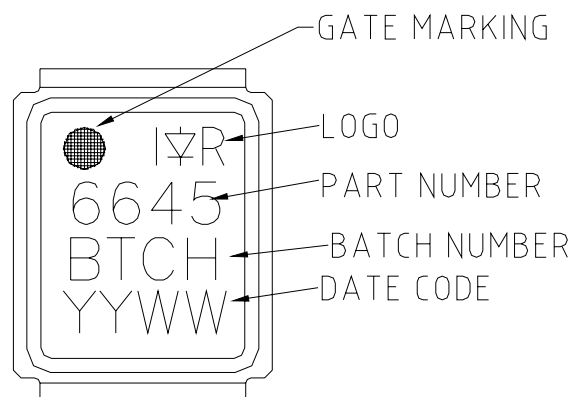



DirectFET™ Tape & Reel Dimension (Showing component orientation).

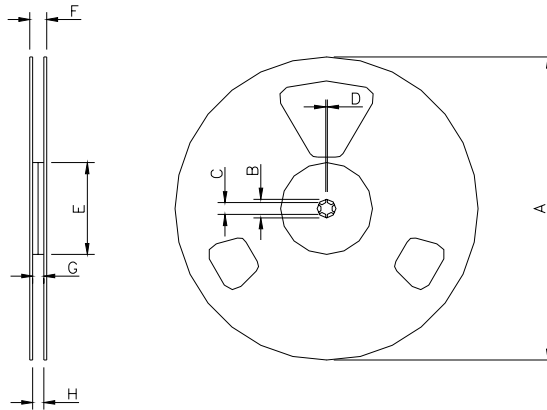

NOTE: Controlling dimensions in mm  
 Std reel quantity is 4800 parts. (ordered as IRF6645). For 1000 parts on 7" reel, order IRF6645TR1

| REEL DIMENSIONS |                            |      |          |       |                       |       |          |      |
|-----------------|----------------------------|------|----------|-------|-----------------------|-------|----------|------|
| CODE            | STANDARD OPTION (QTY 4800) |      |          |       | TR1 OPTION (QTY 1000) |       |          |      |
|                 | METRIC                     |      | IMPERIAL |       | METRIC                |       | IMPERIAL |      |
| A               | 330.0                      | N.C  | 12.992   | N.C   | 177.77                | N.C   | 6.9      | N.C  |
| B               | 20.2                       | N.C  | 0.795    | N.C   | 19.06                 | N.C   | 0.75     | N.C  |
| C               | 12.8                       | 13.2 | 0.504    | 0.520 | 13.5                  | 12.8  | 0.53     | 0.50 |
| D               | 1.5                        | N.C  | 0.059    | N.C   | 1.5                   | N.C   | 0.059    | N.C  |
| E               | 100.0                      | N.C  | 3.937    | N.C   | 58.72                 | N.C   | 2.31     | N.C  |
| F               | N.C                        | 18.4 | N.C      | 0.724 | N.C                   | 13.50 | N.C      | 0.53 |
| G               | 12.4                       | 14.4 | 0.488    | 0.567 | 11.9                  | 12.01 | 0.47     | N.C  |
| H               | 11.9                       | 15.4 | 0.469    | 0.606 | 11.9                  | 12.01 | 0.47     | N.C  |

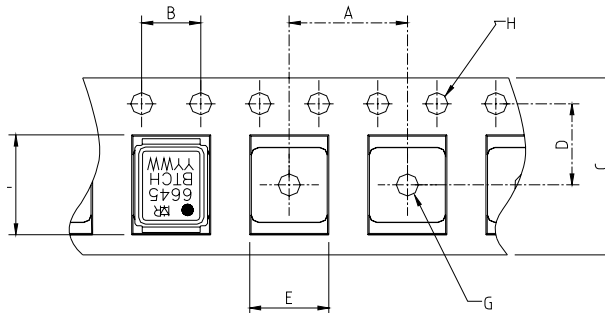

NOTE: CONTROLLING DIMENSIONS IN MM

| DIMENSIONS |        |       |          |
|------------|--------|-------|----------|
|            | METRIC |       | IMPERIAL |
|            | MIN    | MAX   | MAX      |
|            | 7.90   | 8.10  | 0.319    |
|            | 3.90   | 4.10  | 0.161    |
|            | 11.90  | 12.30 | 0.484    |
|            | 5.45   | 5.55  | 0.219    |
|            | 4.00   | 4.20  | 0.165    |
|            | 5.00   | 5.20  | 0.205    |
|            | 1.50   | N.C   | N.C      |
|            | 1.50   | 1.60  | 0.063    |

Data and specifications subject to change without notice.  
 This product has been designed and qualified for the Consumer market.  
 Qualification Standards can be found on IR's Web site.

Note: For the most current drawings please refer to the IR website at:  
<http://www.irf.com/package/>

# Mouser Electronics

Authorized Distributor

Click to View Pricing, Inventory, Delivery & Lifecycle Information:

[Infineon:](#)

[IRF6645](#)