

NJM2831

■ OUTPUT VOLTAGE

The WHITE column shows applicable Voltage Rank(s)

Device Name	Vout	Device Name	Vout	Device Name	Vout
NJM2831F-21	2.1V	NJM2831F-41	4.1V	NJM2831F-116	11.6V
NJM2831F-22	2.2V	NJM2831F-42	4.2V	NJM2831F-12	12.0V
NJM2831F-23	2.3V	NJM2831F-43	4.3V	NJM2831F-125	12.5V
NJM2831F-24	2.4V	NJM2831F-44	4.4V	NJM2831F-13	13.0V
NJM2831F-25	2.5V	NJM2831F-45	4.5V	NJM2831F-135	13.5V
NJM2831F-26	2.6V	NJM2831F-46	4.6V	NJM2831F-15	15.0V
NJM2831F-27	2.7V	NJM2831F-47	4.7V	NJM2831F-155	15.5V
NJM2831F-28	2.8V	NJM2831F-48	4.8V		
NJM2831F-29	2.9V	NJM2831F-49	4.9V		
NJM2831F-03	3.0V	NJM2831F-05	5.0V		
NJM2831F-31	3.1V	NJM2831F-53	5.3V		
NJM2831F-32	3.2V	NJM2831F-06	6.0V		
NJM2831F-33	3.3V	NJM2831F-64	6.4V		
NJM2831F-34	3.4V	NJM2831F-07	7.0V		
NJM2831F-35	3.5V	NJM2831F-08	8.0V		
NJM2831F-36	3.6V	NJM2831F-82	8.2V		
NJM2831F-37	3.7V	NJM2831F-85	8.5V		
NJM2831F-38	3.8V	NJM2831F-09	9.0V		
NJM2831F-39	3.9V	NJM2831F-92	9.2V		
NJM2831F-04	4.0V	NJM2831F-10	10.0V		

ESON Type Available Voltage Rank(s)

Device Name	Vout	Device Name	Vout	Device Name	Vout
NJM2831KG1-33	3.3V	NJM2831KG1-52	5.2V		

■ ABSOLUTE MAXIMUM RATINGS (Ta=25°C)

PARAMETER	SYMBOL	RATINGS	UNIT	
Input Voltage	V_{IN}	+20	V	
Control Voltage	V_{CONT}	+20(*1)	V	
Power Dissipation	P_D	SOT-23-5	500(*2)	mW
			250(*3)	
		ESON6	420(*4)	
			1135(*5)	
Operating Temperature	T_{opr}	-40~+85	°C	
Storage Temperature	T_{stg}	-40~+150	°C	

(*1): When input voltage is less than +20V, the absolute maximum control voltage is equal to the input voltage.

(*2): Mounted on glass epoxy board based on EIA/JEDEC. (114.3x76.2x1.6mm: 2Layers)

(*3): Device itself.

(*4): Mounted on glass epoxy board based on EIA/JEDEC STANDARD.

(101.5x114.5x1.6mm: 2Layers FR-4, copper area 100mm²)

(*5): Mounted on glass epoxy board based on EIA/JEDEC STANDARD. (101.5 × 114.5 × 1.6mm: 4Layers FR-4, Internal foil area size: 99.5 × 99.5mm, Applying a thermal via hole to a board based on JEDEC standard JESD51-5)

■ ELECTRICAL CHARACTERISTICS

($V_{IN}=V_o+1V$, $C_{IN}=0.1\mu F$, $C_o=1.0\mu F$ (2.8V< V_o ≤5.4V: $C_o=2.2\mu F$, V_o ≤2.8V: $C_o=4.7\mu F$), $T_a=25^\circ C$)

PARAMETER	SYMBOL	TEST CONDITION	MIN.	TYP.	MAX.	UNIT	
Output Voltage	V_o	$I_o=30mA$	-1.0%	–	+1.0%	V	
Quiescent Current	I_Q	$I_o=0mA$, except I_{cont}	$V_o \leq 5V$ Version	–	120	180	μA
			$5V < V_o \leq 10V$ Version	–	135	195	μA
			$10V < V_o \leq 15V$ Version	–	150	210	μA
Quiescent Current at Control OFF	$I_{Q(OFF)}$	$V_{CONT}=0V$	–	–	100	nA	
Output Current	I_o	$V_o=0.3V$	100	130	–	mA	
Line Regulation	$\Delta V_o / \Delta V_{IN}$	$V_{IN}=V_o+1V \sim V_o+6V$ ($V_o \leq 12V$ Version) $V_{IN}=V_o+1V \sim 18V$ ($V_o > 12V$ Version), $I_o=30mA$	–	–	0.10	%/V	
Load Regulation	$\Delta V_o / \Delta I_o$	$I_o=0 \sim 60mA$	–	–	0.03	%/mA	
Dropout Voltage(*4)	ΔV_{I-O}	$I_o=60mA$	–	0.10	0.18	V	
Ripple Rejection	RR	$e_{in}=200mV_{rms}$, $f=1kHz$, $I_o=10mA$, $V_o=3V$ Version	–	75	–	dB	
Average Temperature Coefficient of Output Voltage	$\Delta V_o / \Delta T_a$	$T_a=0 \sim 85^\circ C$, $I_o=10mA$	–	± 50	–	ppm/ °C	
Output Noise Voltage	V_{NO}	$f=10Hz \sim 80kHz$, $I_o=10mA$ $V_o=3V$ Version	–	45	–	μV_{rms}	
Control Current	I_{cont}	$V_{CONT}=1.6V$	–	3	12	μA	
Control Voltage for ON-state	$V_{CONT(ON)}$		1.6	–	–	V	
Control Voltage for OFF-state	$V_{CONT(OFF)}$		–	–	0.6	V	
Input Voltage	V_{IN}		–	–	18	V	

(*4): The above specification is a common specification for all output voltages.

Therefore, it may be different from the individual specification for a specific output voltage.

NJM2831

TEST CIRCUIT

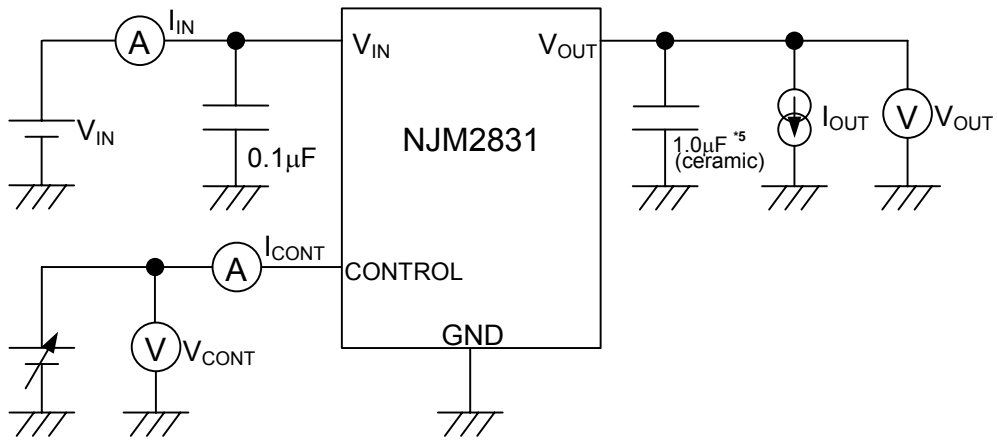

*5 2.8V < V_o ≤ 5.4V version: C_o = 2.2 μF (ceramic)
 V_o ≤ 2.8V version: C_o = 4.7 μF (ceramic)

TYPICAL APPLICATIONS

① In the case where ON/OFF Control is not required:

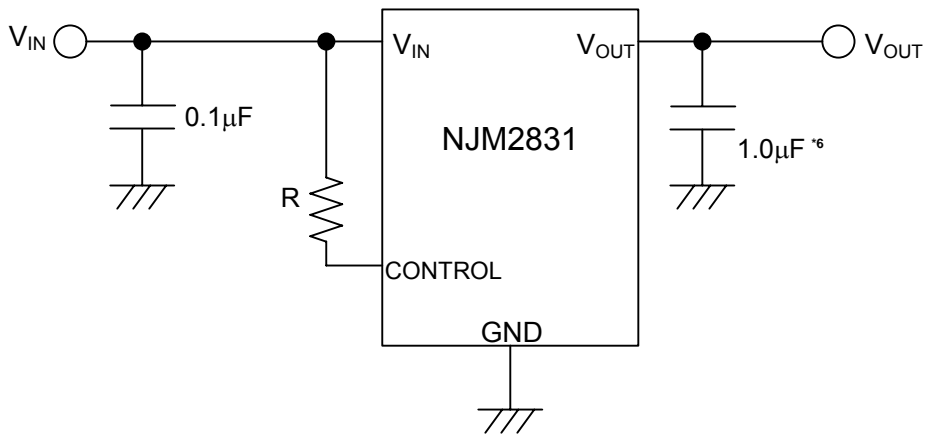

*6 2.8V < V_o ≤ 5.4V version: C_o = 2.2 μF
 V_o ≤ 2.8V version: C_o = 4.7 μF

Connect control terminal to V_{IN} terminal

② In use of ON/OFF CONTROL:

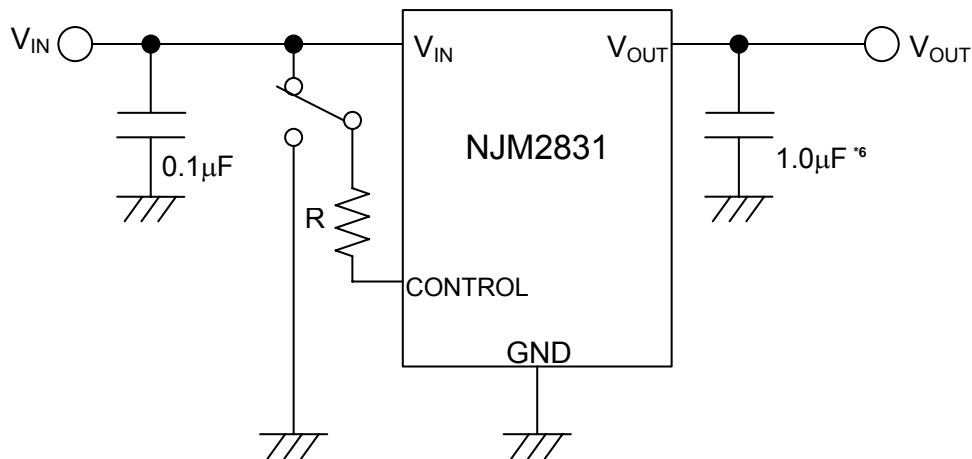

*6 2.8V < V_o ≤ 5.4V version: $C_o = 2.2\mu\text{F}$
 V_o ≤ 2.8V version: $C_o = 4.7\mu\text{F}$

State of control terminal:

- "H" → output is enabled.
- "L" or "open" → output is disabled.

*In the case of using a resistance "R" between V_{IN} and control.

The current flow into the control terminal while the IC is ON state (I_{CONT}) can be reduced when a pull up resistance "R" is inserted between V_{IN} and the control terminal.

The minimum control voltage for ON state ($V_{CONT(ON)}$) is increased due to the voltage drop caused by I_{CONT} and the resistance "R". The I_{CONT} is temperature dependence as shown in the "Control Current vs. Temperature" characteristics. Therefore, the resistance "R" should be carefully selected to ensure the control voltage exceeds the $V_{CONT(ON)}$ over the required temperature range.

*Input Capacitance C_{IN}

Input capacitance C_{IN} is required to prevent oscillation and reduce power supply ripple for applications with high power supply impedance or a long power supply line.

Use the C_{IN} value of 0.1 μ F greater to avoid the problem.

C_{IN} should connect between GND and V_{IN} as short as possible.

*Output Capacitance C_O

Output capacitor (C_O) will be required for a phase compensation of the internal error amplifier.

The capacitance and the equivalent series resistance (ESR) influence to stable operation of the regulator.

This product is designed to work with a low ESR capacitor (C_O). However use of recommended capacitance or larger value is effective for stable operation.

Use of a smaller C_O may cause excess output noise or oscillation of the regulator due to lack of the phase compensation.

Therefore use C_O with the recommended capacitance or larger value and connect between V_O terminal and GND terminal with shortest path. The recommended capacitance depends on the output voltage rank. Low voltage regulator requires larger value C_O . Thus, check the recommended capacitance for each output voltage rank.

In addition, You should consider varied characteristics of capacitor (a frequency characteristic, a temperature characteristic, a DC bias characteristic and so on) and unevenness peculiar to a capacitor supplier enough. We recommend that withstand voltage margin against output voltage and superior in a temperature characteristic, when selecting Output capacitor.

Uses of a larger C_O reduces output noise and ripple output, and also improves output transient response against rapid load change.

■ TYPICAL CHARACTERISTICS

● DC CHARACTERISTICS (3V Version)

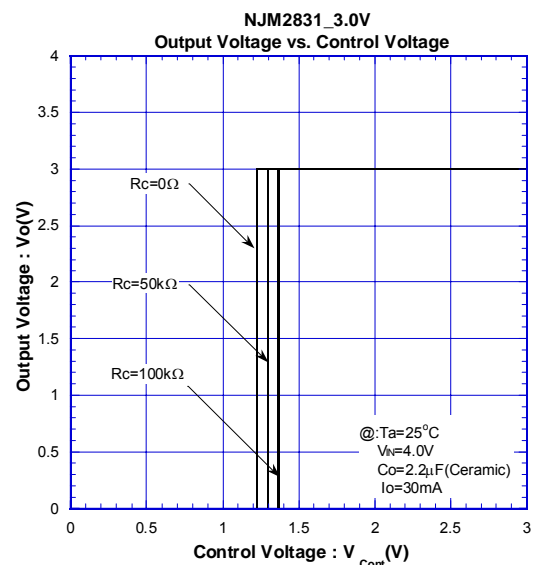
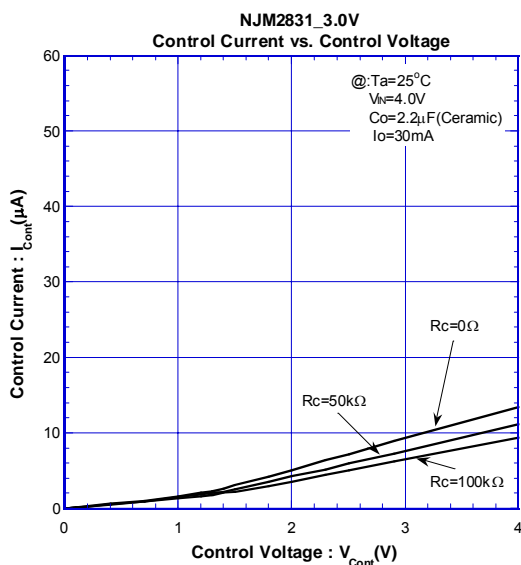
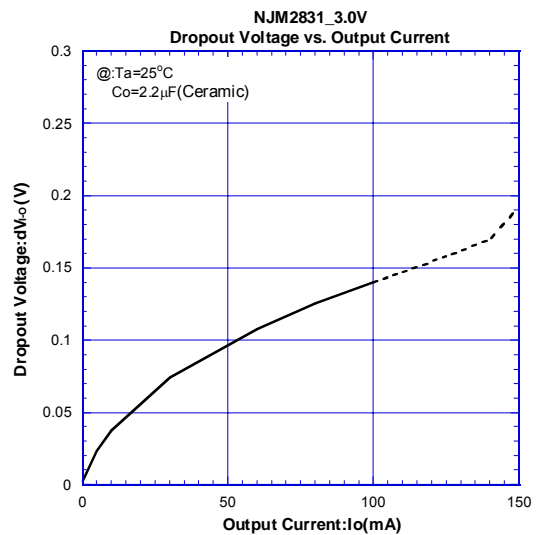
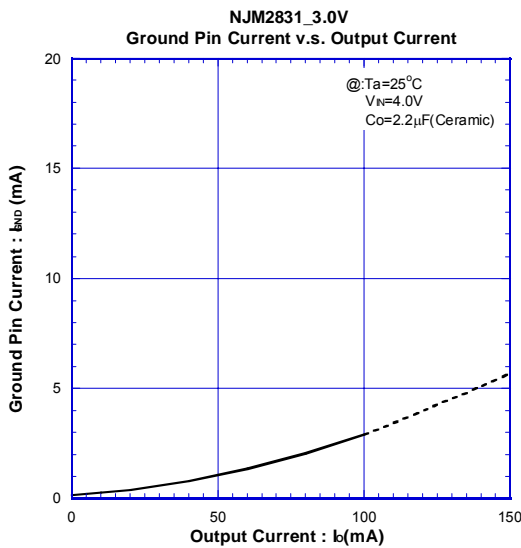
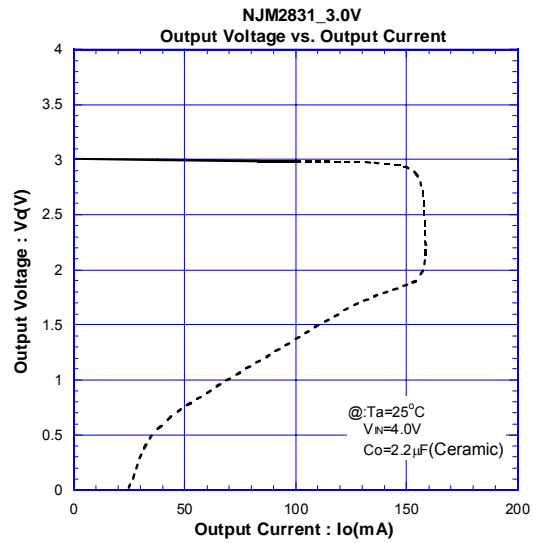
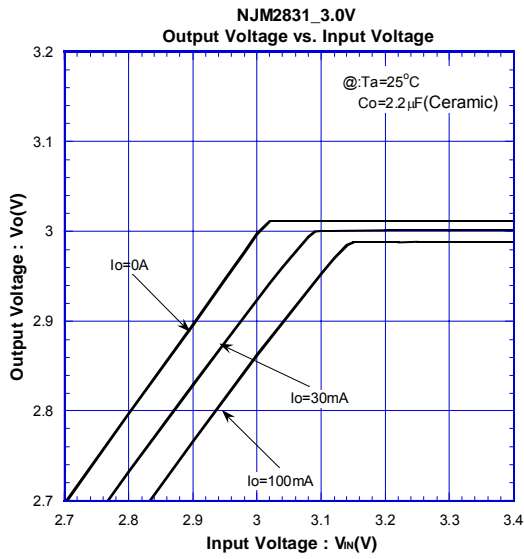

NJM2831

TYPICAL CHARACTERISTICS

DC CHARACTERISTICS (3V Version)

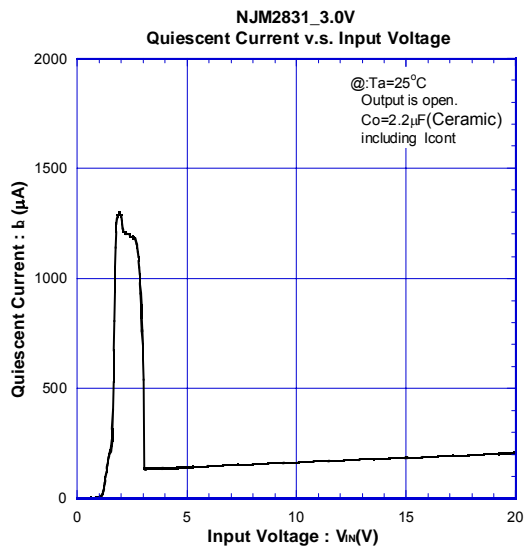
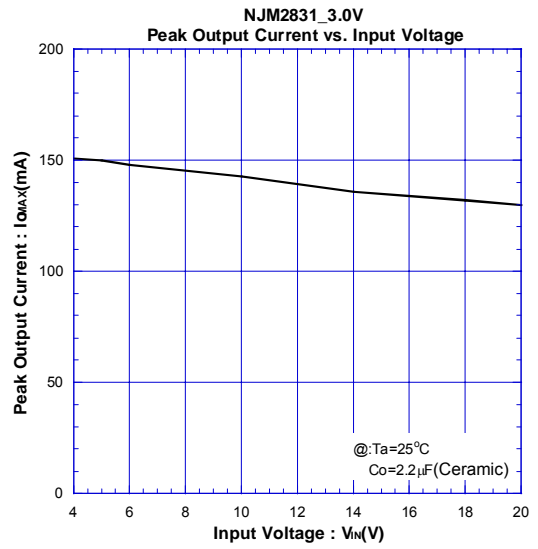
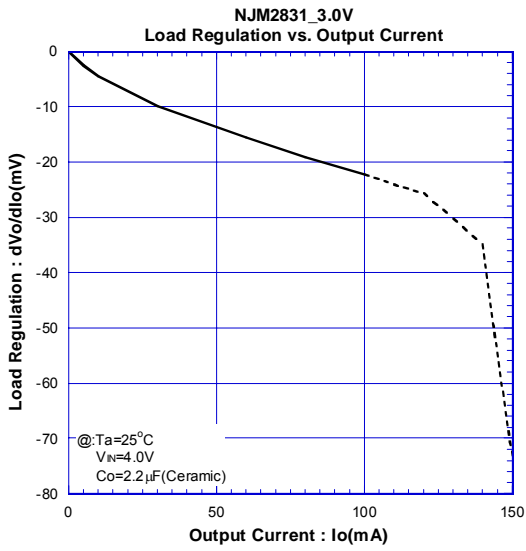

TYPICAL CHARACTERISTICS

AC CHARACTERISTICS (3V Version)

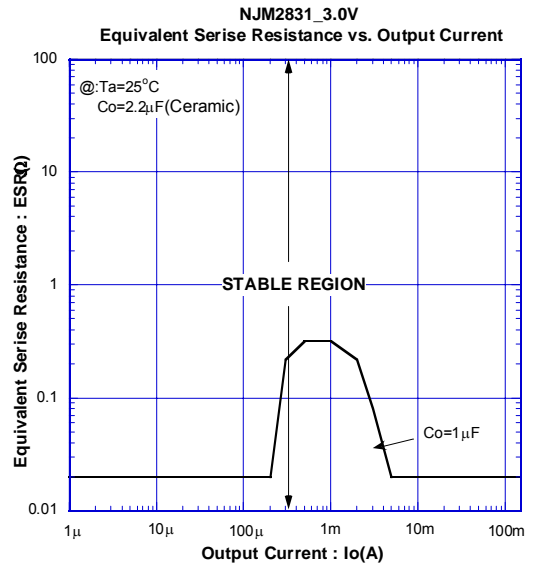
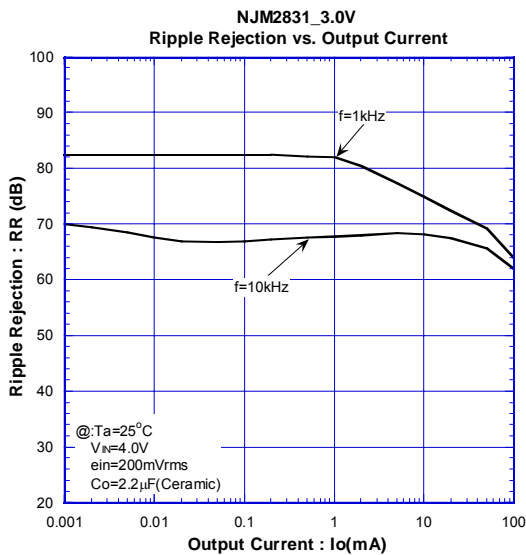
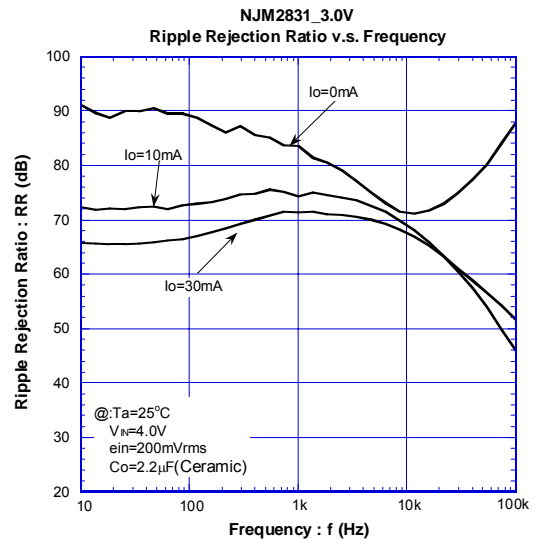
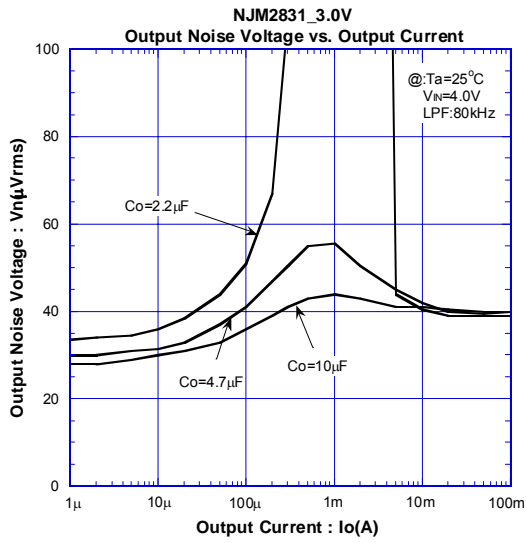

NJM2831

■ TYPICAL CHARACTERISTICS

● TEMPERATURE CHARACTERISTICS (3V Version)

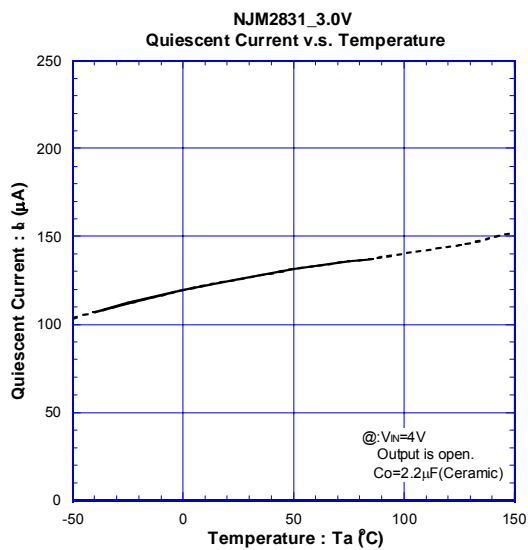
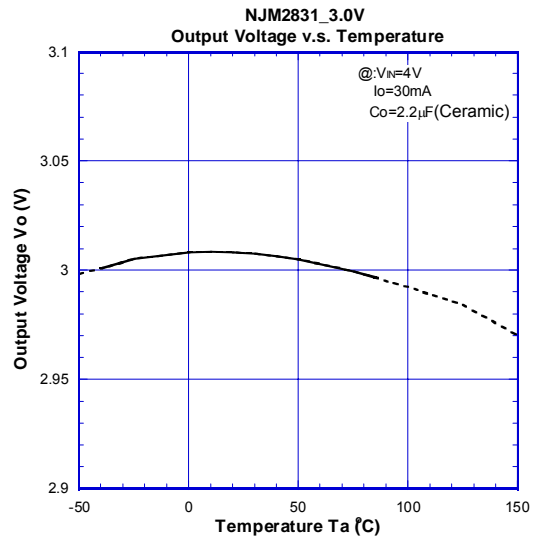
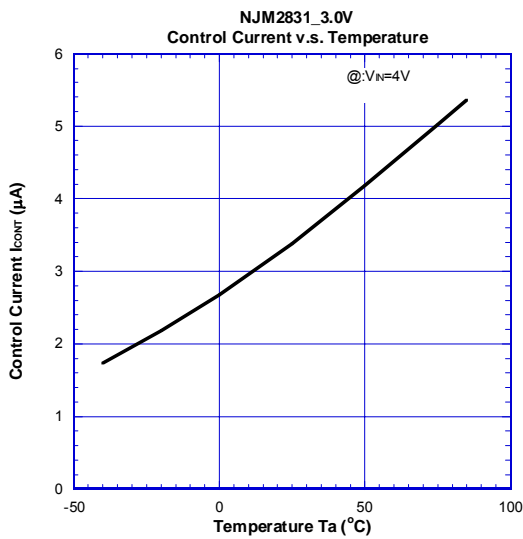
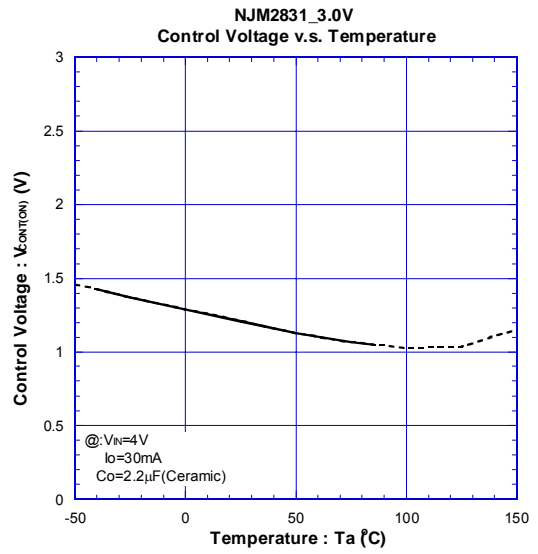
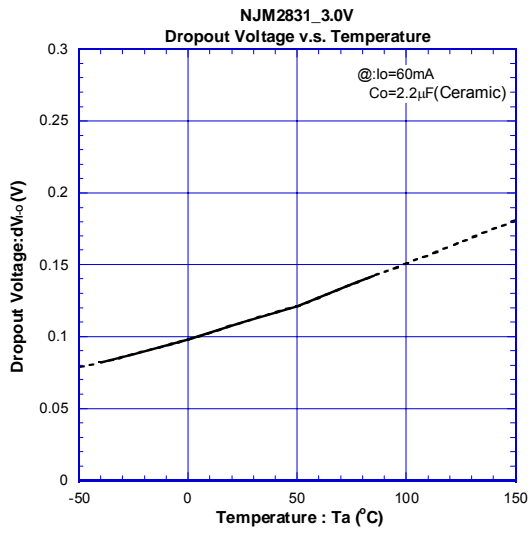

TYPICAL CHARACTERISTICS

● TEMPERATURE CHARACTERISTICS (3V Version)

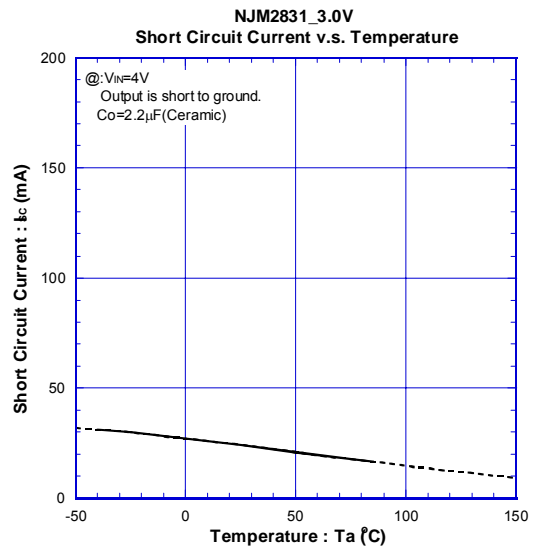
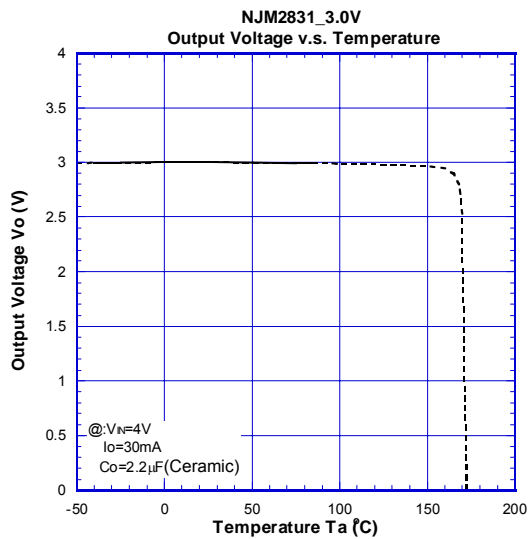
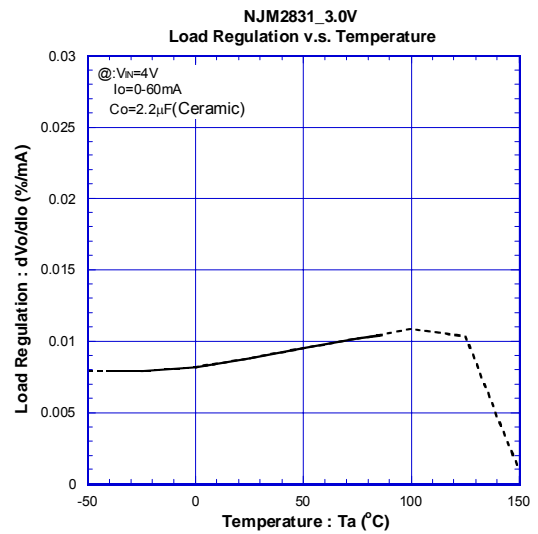
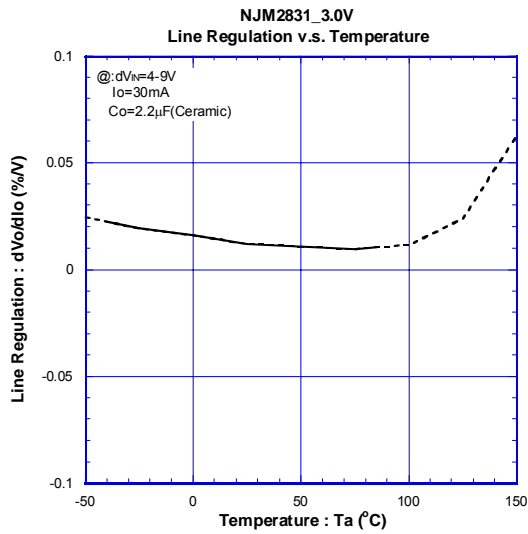

NJM2831

TYPICAL CHARACTERISTICS

TRANSIENT RESPONSE (3V Version)

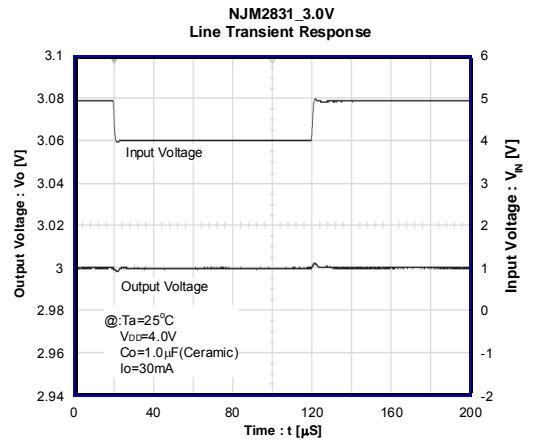
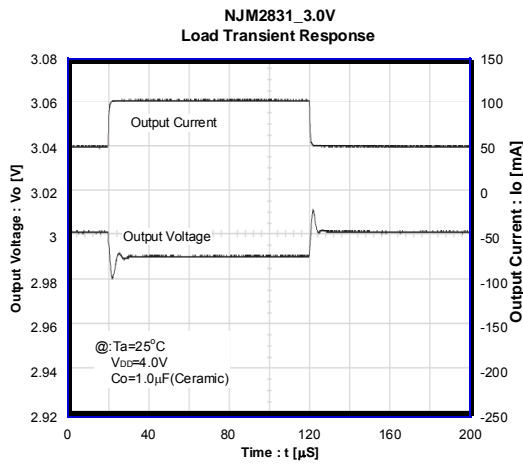
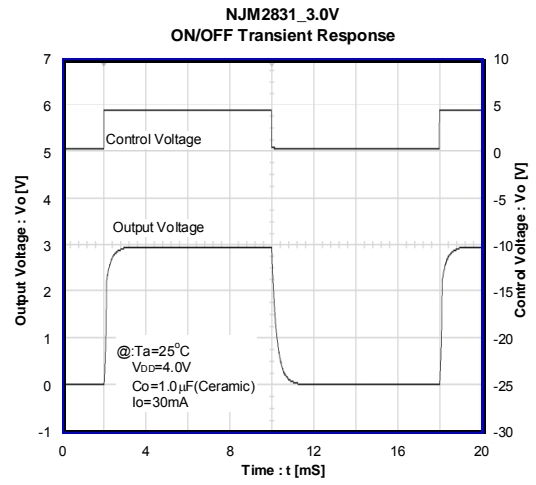
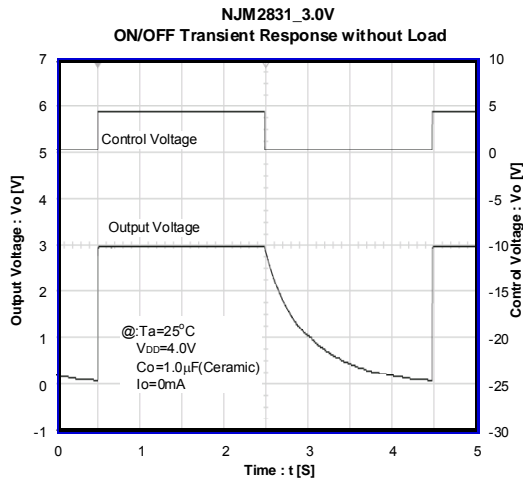

TYPICAL CHARACTERISTICS

DC CHARACTERISTICS (8.5V Version)

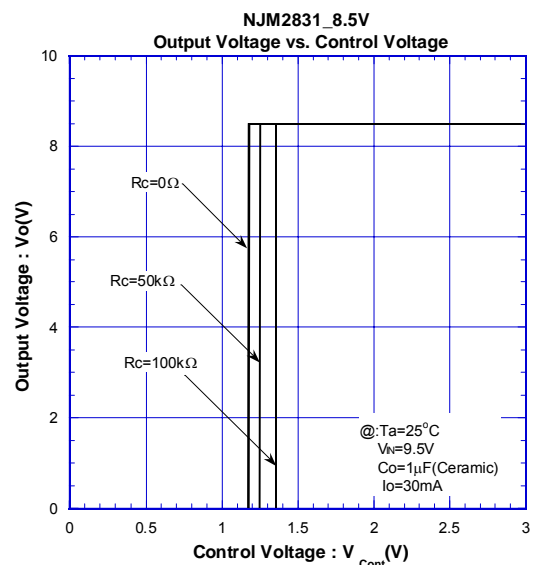
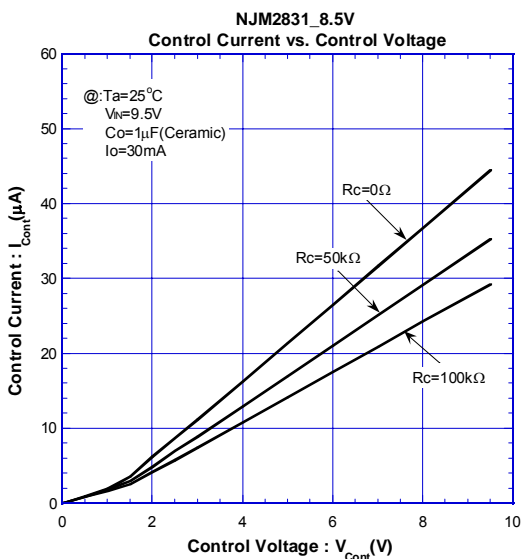
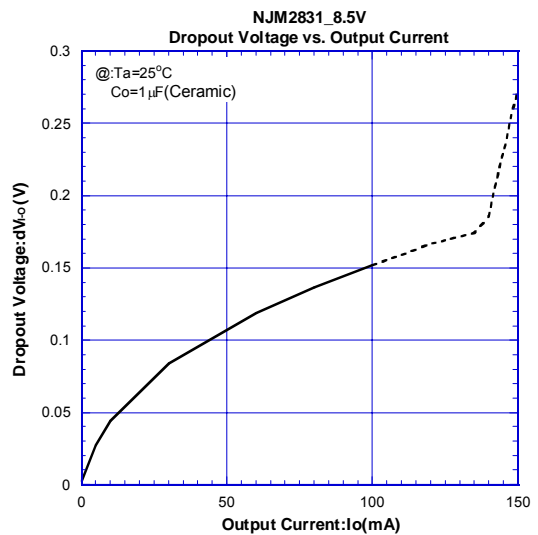
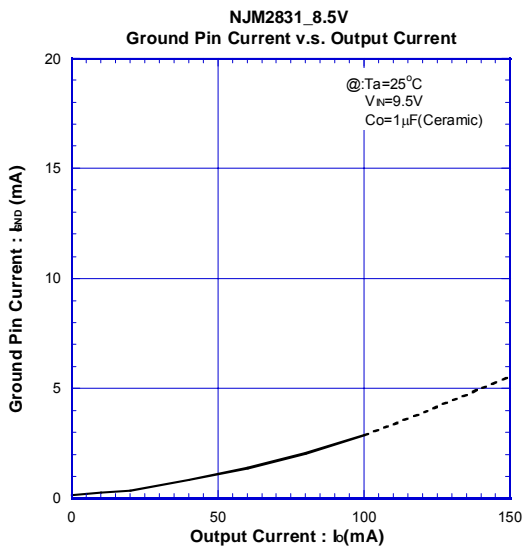
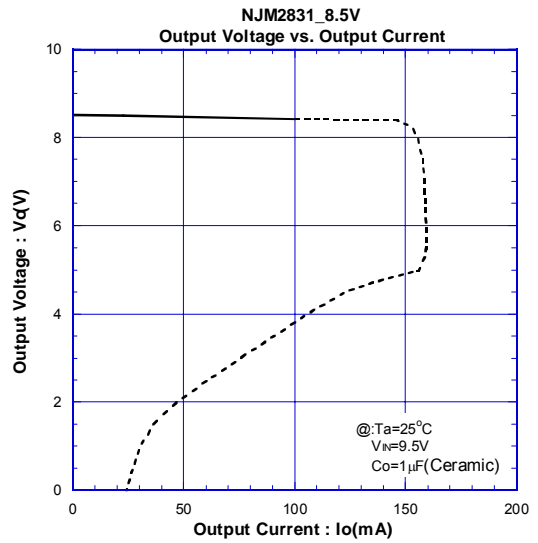
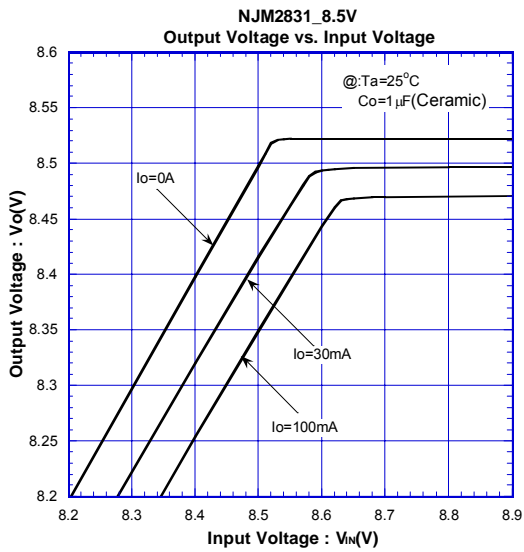

NJM2831

■ TYPICAL CHARACTERISTICS

● DC CHARACTERISTICS (8.5V Version)

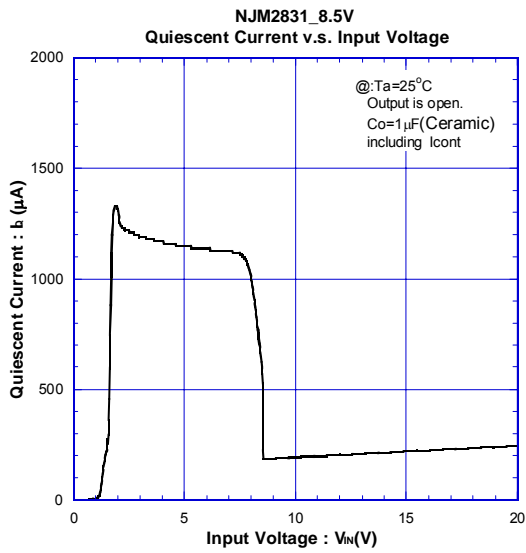
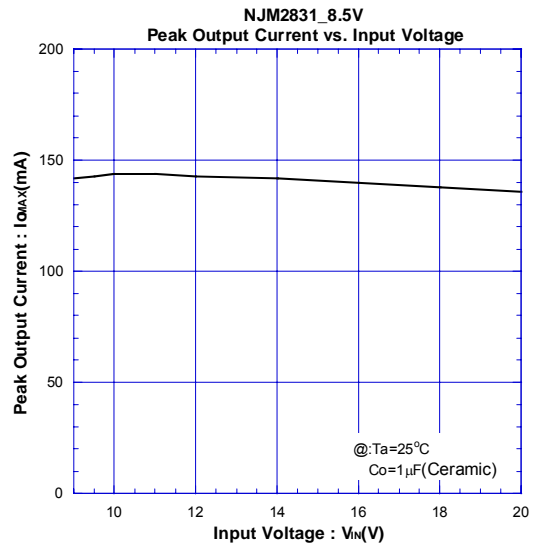
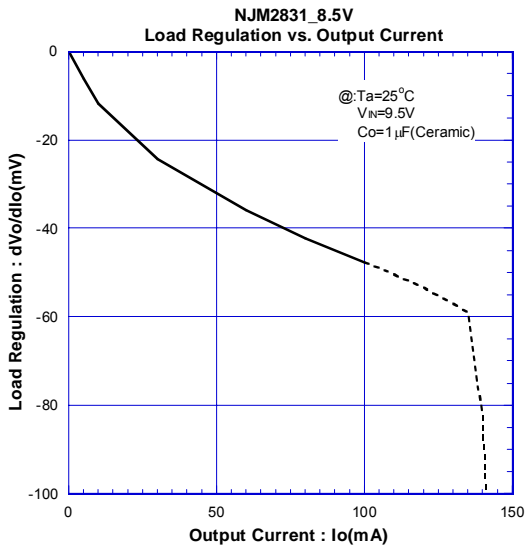

TYPICAL CHARACTERISTICS

AC CHARACTERISTICS (8.5V Version)

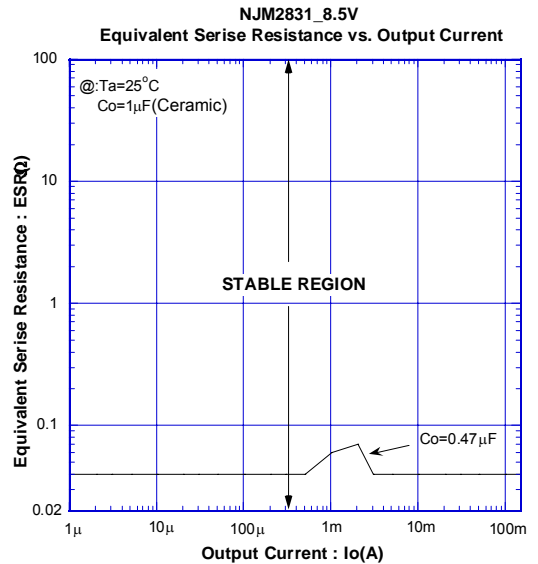
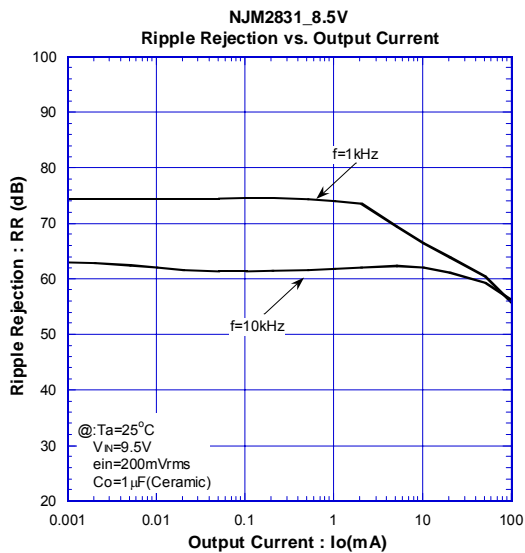
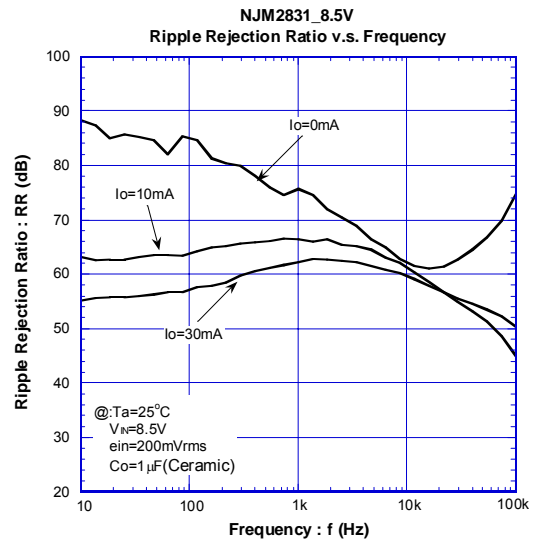
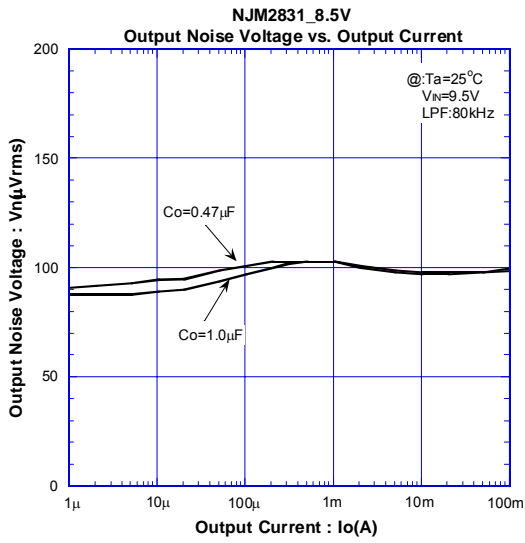

NJM2831

■ TYPICAL CHARACTERISTICS

● TEMPERATURE CHARACTERISTICS (8.5V Version)

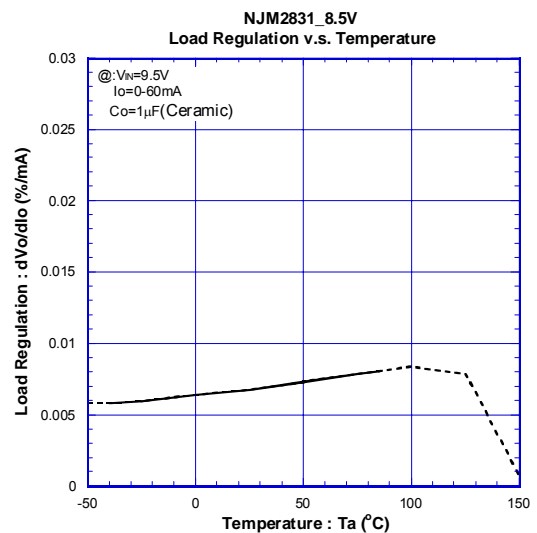
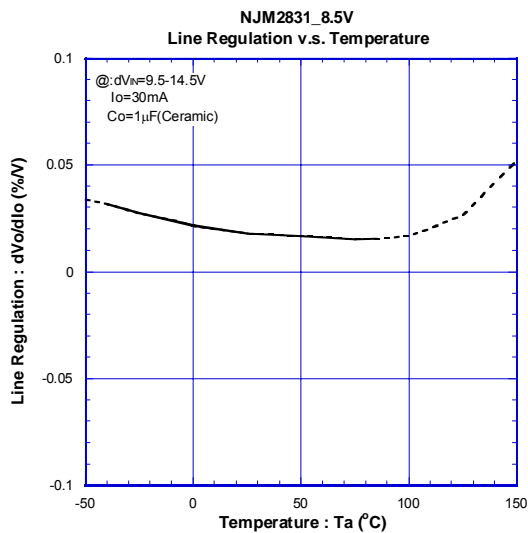
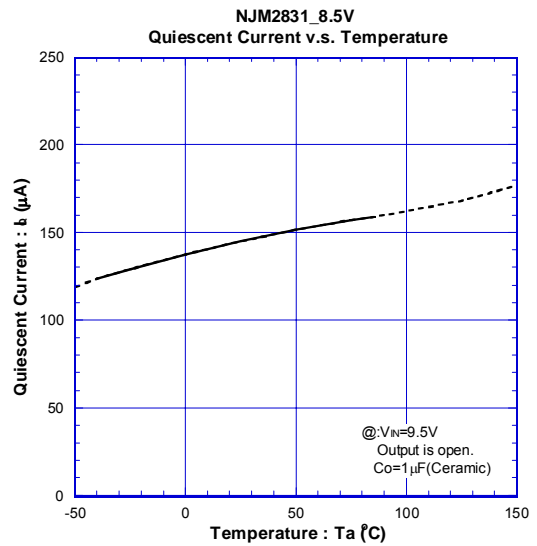
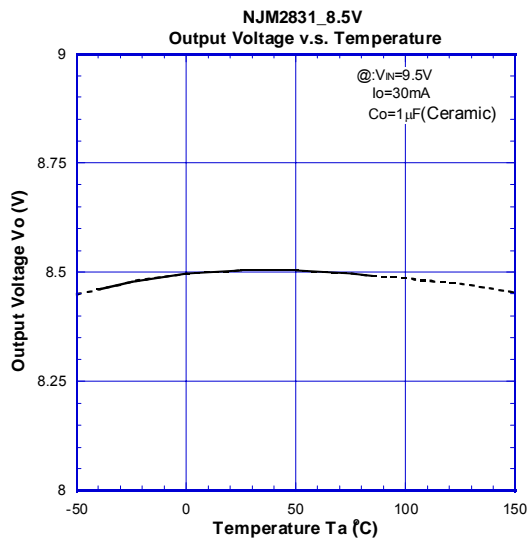
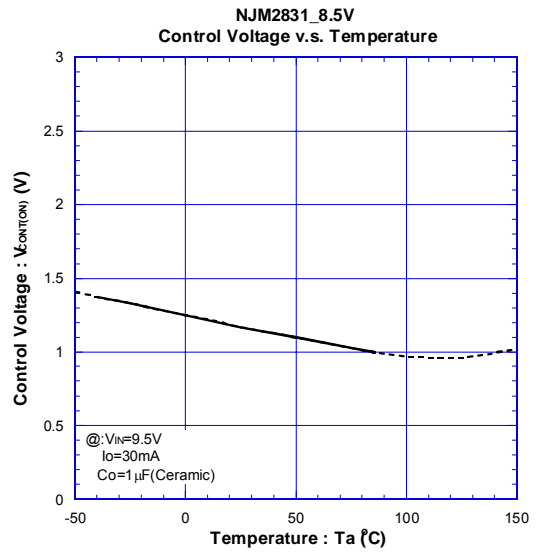
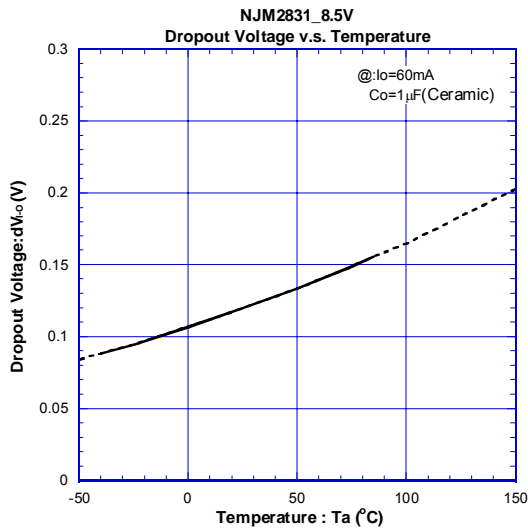

■ TYPICAL CHARACTERISTICS

● TEMPERATURE CHARACTERISTICS (8.5V Version)

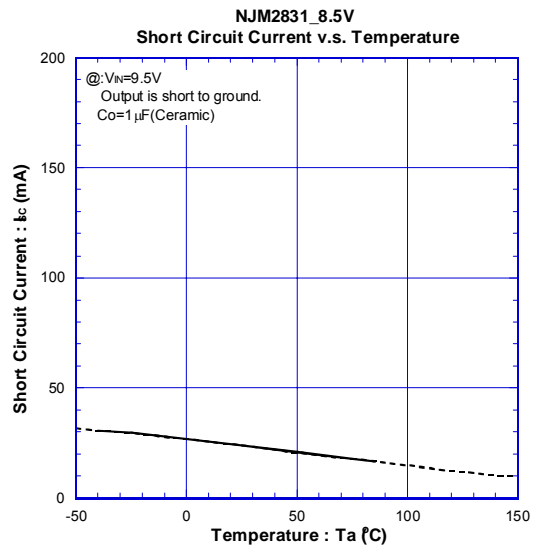
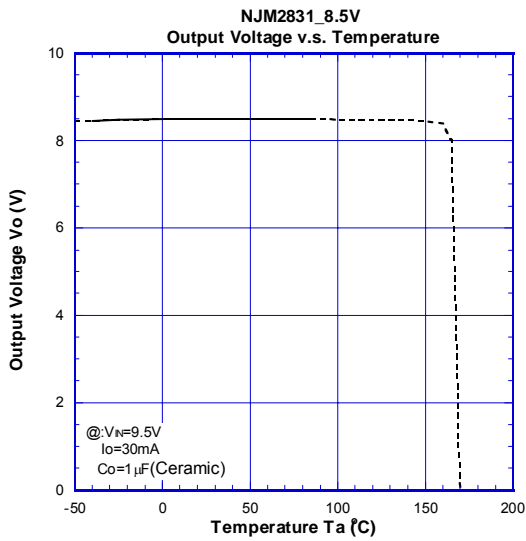

● TRANSIENT RESPONSE (8.5V Version)

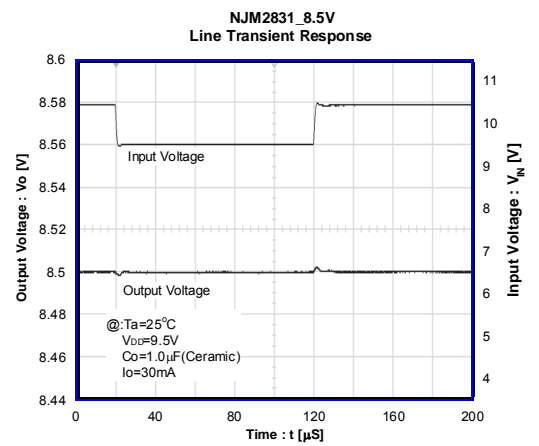
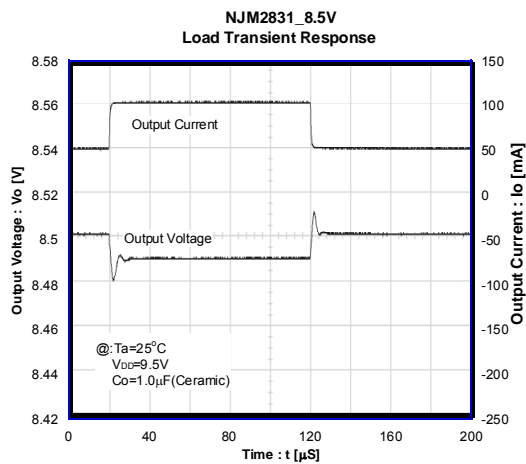
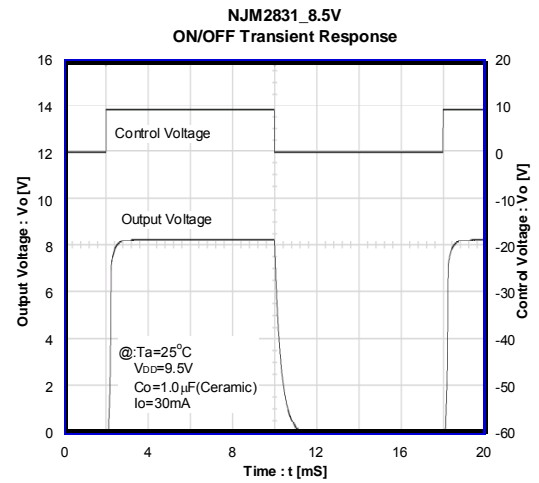
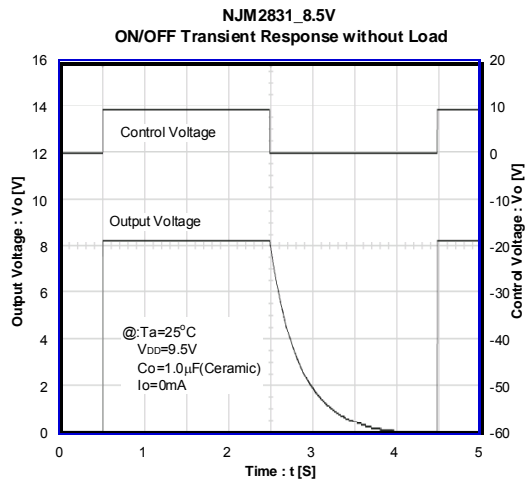

NJM2831

■ TYPICAL CHARACTERISTICS

● DC CHARACTERISTICS (15V Version)

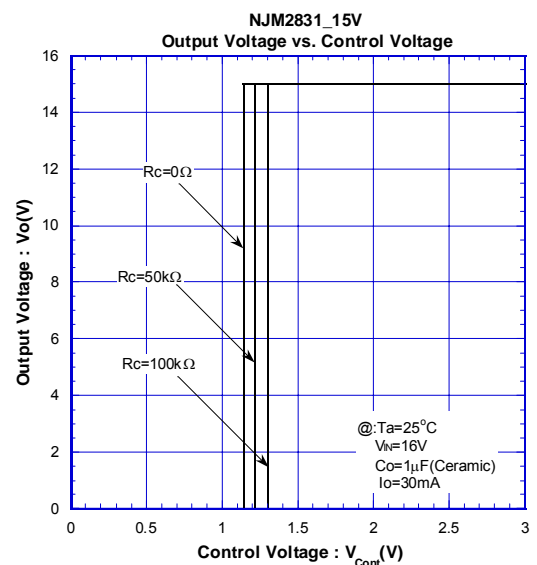
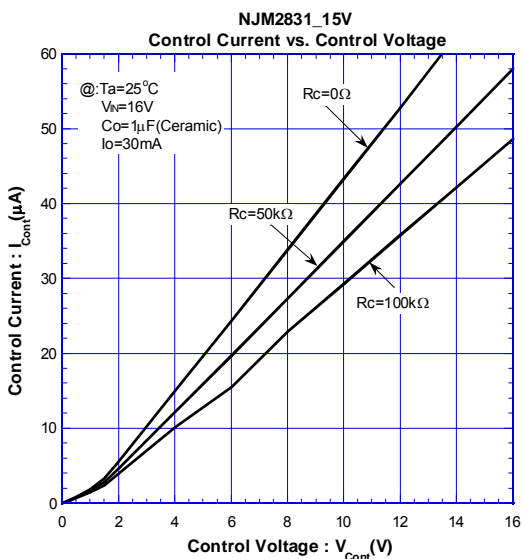
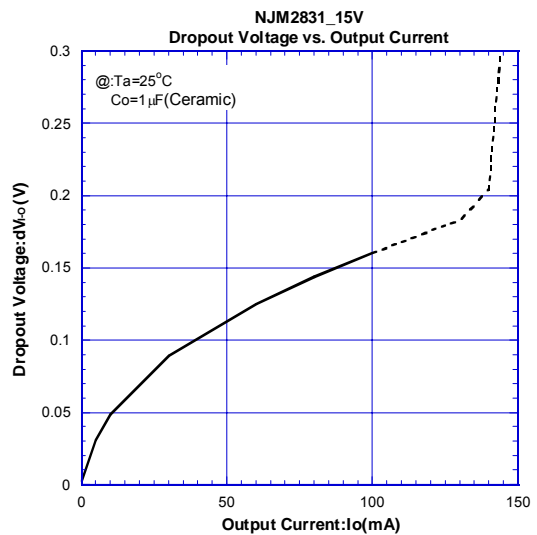
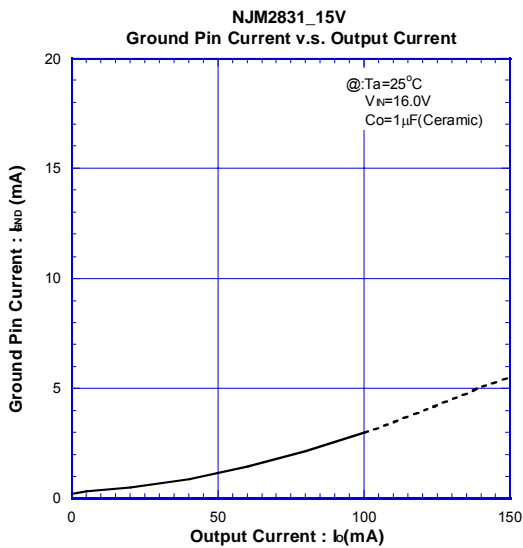
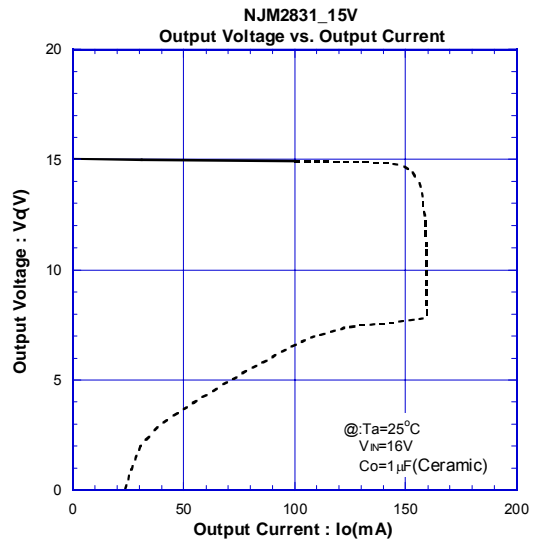
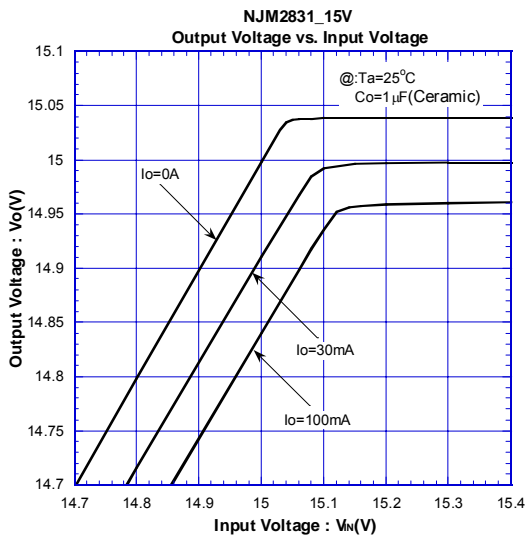

TYPICAL CHARACTERISTICS

DC CHARACTERISTICS (15V Version)

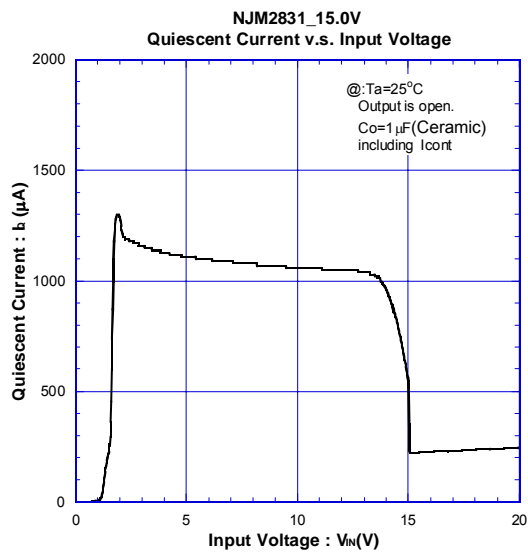
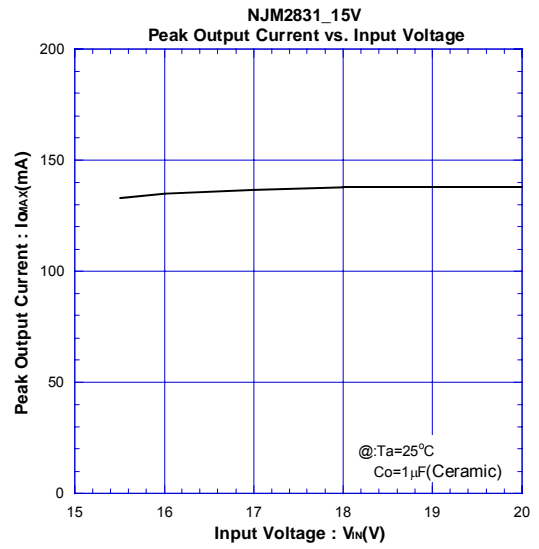
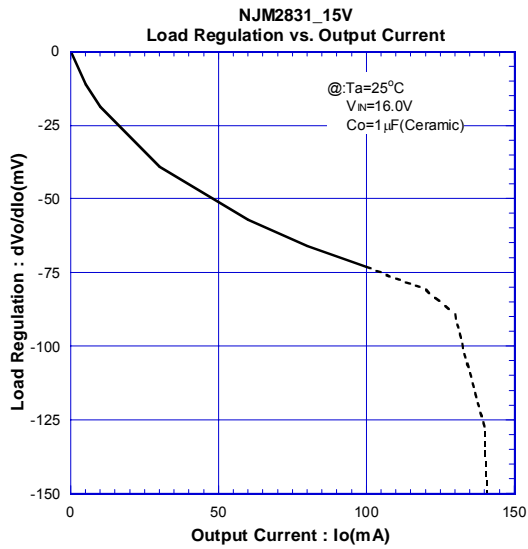

NJM2831

TYPICAL CHARACTERISTICS

AC CHARACTERISTICS (15V Version)

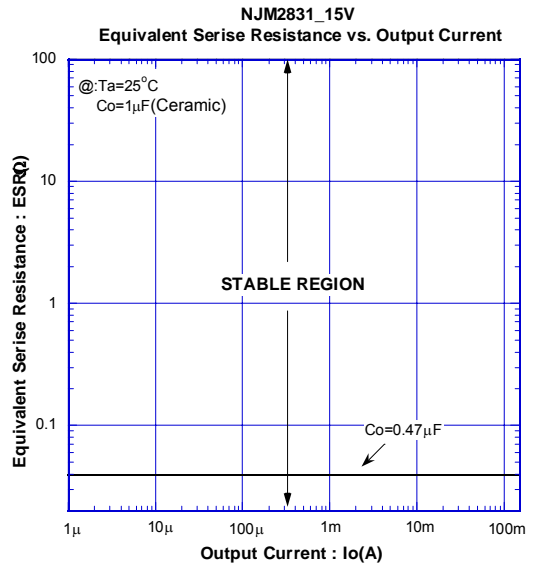
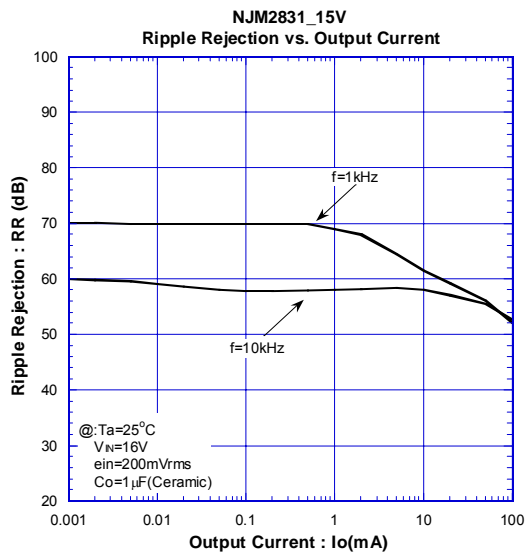
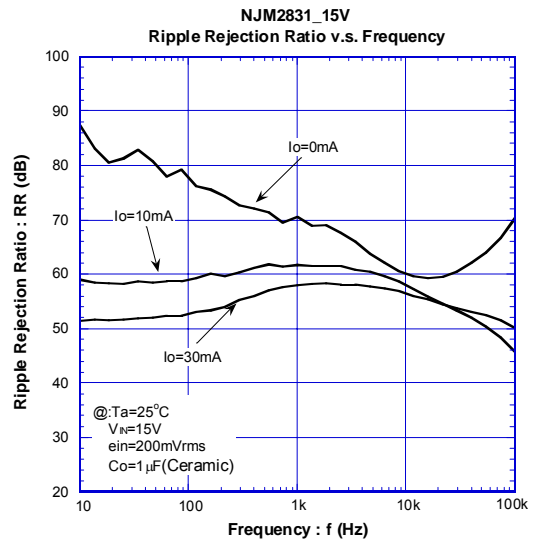
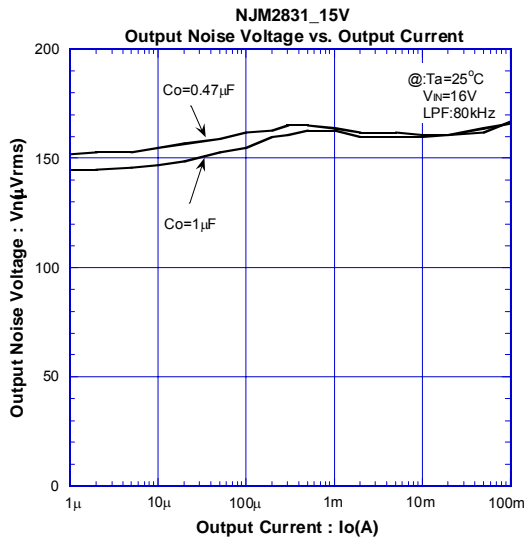

■ TYPICAL CHARACTERISTICS

● TEMPERATURE CHARACTERISTICS (15V Version)

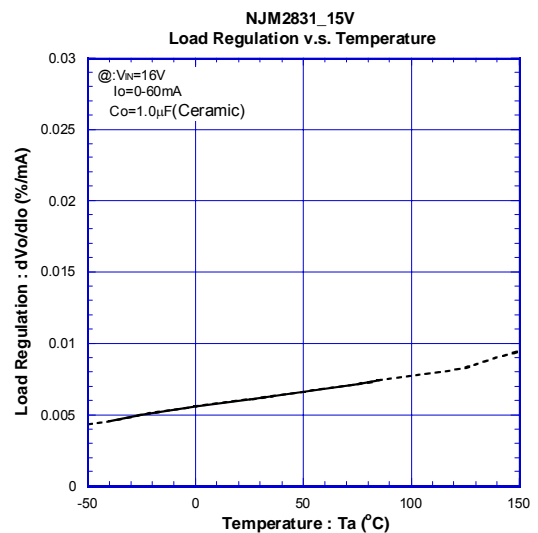
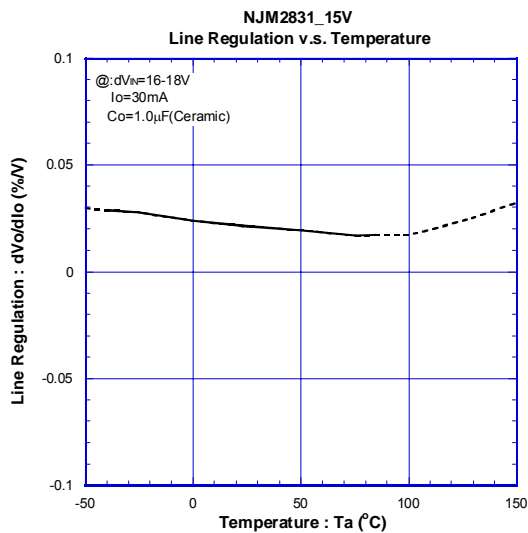
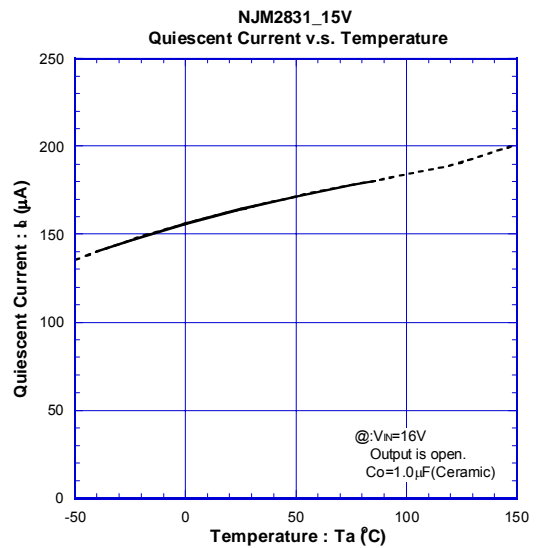
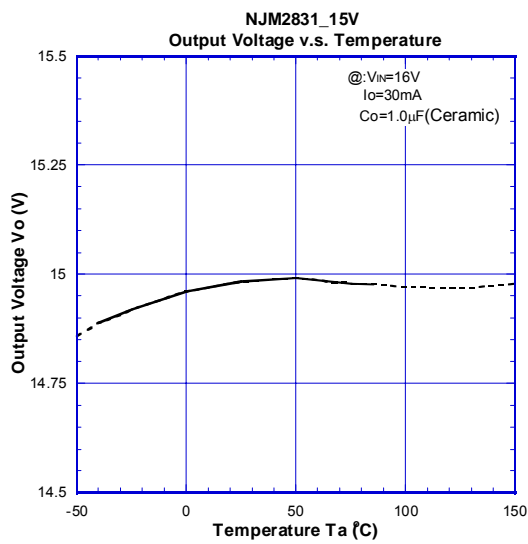
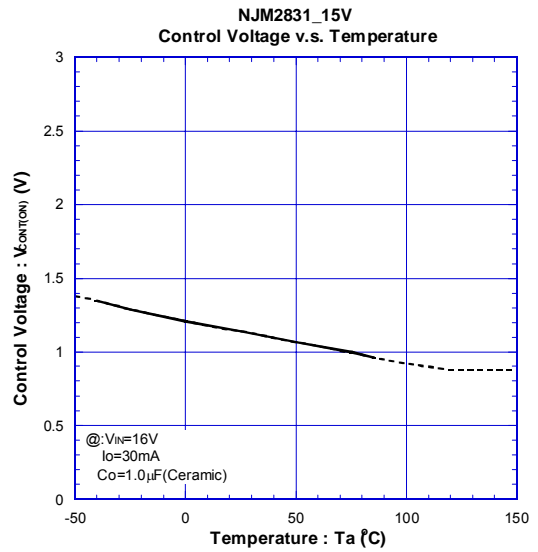
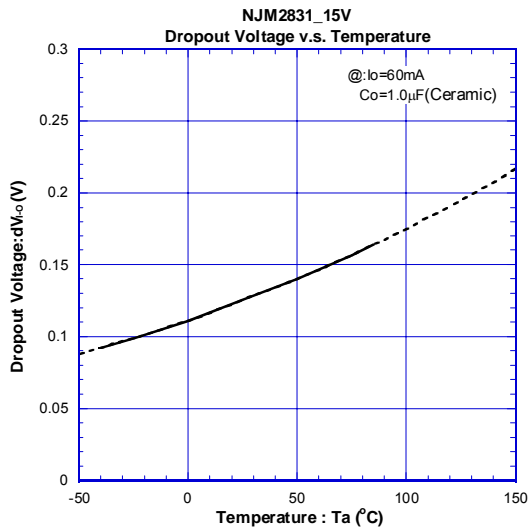

NJM2831

■ TYPICAL CHARACTERISTICS

● TEMPERATURE CHARACTERISTICS (15V Version)

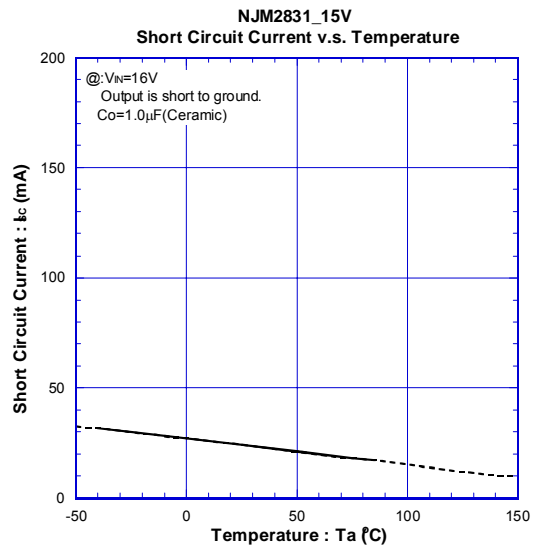
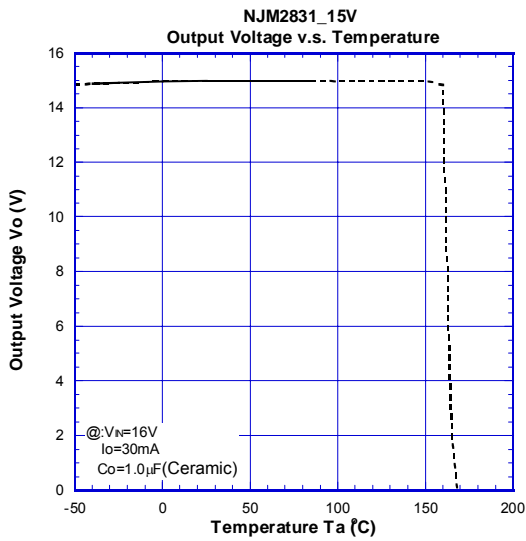

● TRANSIENT RESPONSE (15V Version)

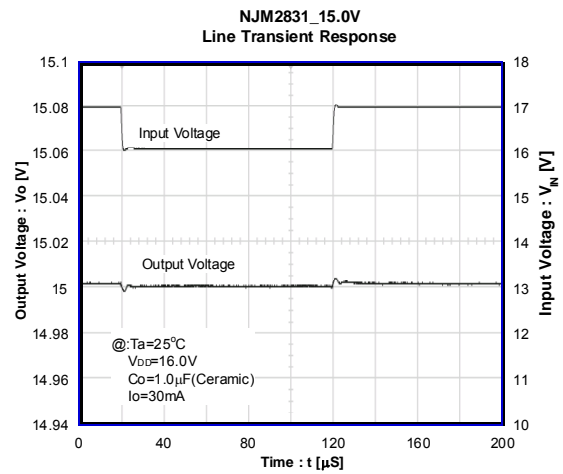
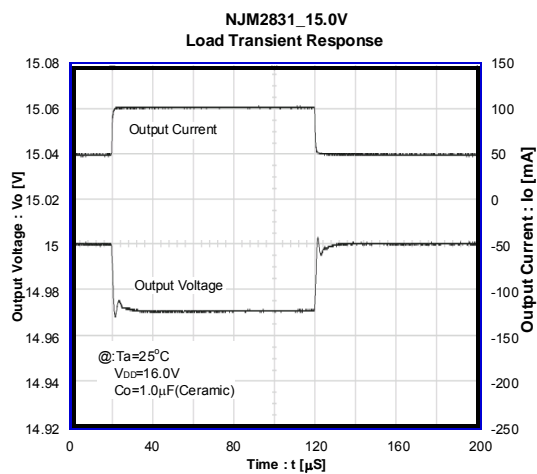
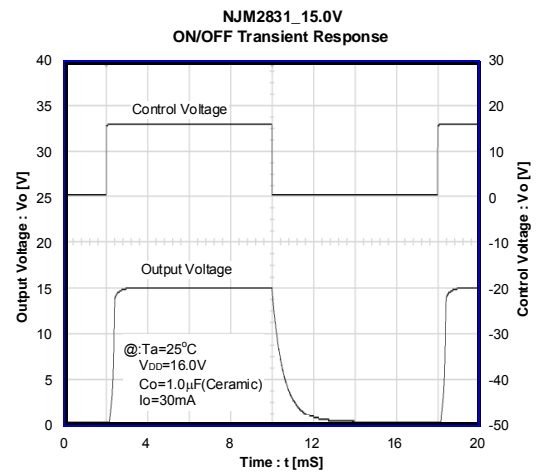
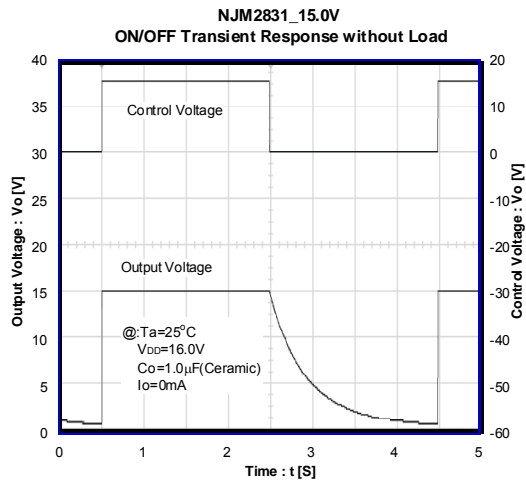

[CAUTION]

The specifications on this databook are only given for information, without any guarantee as regards either mistakes or omissions. The application circuits in this databook are described only to show representative usages of the product and not intended for the guarantee or permission of any right including the industrial rights.

Mouser Electronics

Authorized Distributor

Click to View Pricing, Inventory, Delivery & Lifecycle Information:

[NJR:](#)

[NJM2831F05-TE1](#) [NJM2831F12-TE1](#) [NJM2831F15-TE1](#) [NJM2831F03-TE1](#) [NJM2831F85-TE1](#) [NJM2831F09-TE1](#)
[NJM2831F08-TE1](#) [NJM2831F33-TE1](#) [NJM2831F12-TE2](#) [NJM2831F13-TE1](#) [NJM2831F135-TE1](#) [NJM2831F06-TE1](#)
[NJM2831F125-TE1](#) [NJM2831F92-TE1](#) [NJM#2831F05-TE1](#)