

THIS COPY IS PROVIDED ON A RESTRICTED BASIS AND IS NOT TO BE USED IN ANY WAY DETRIMENTAL TO THE INTERESTS OF PANDUIT CORP.

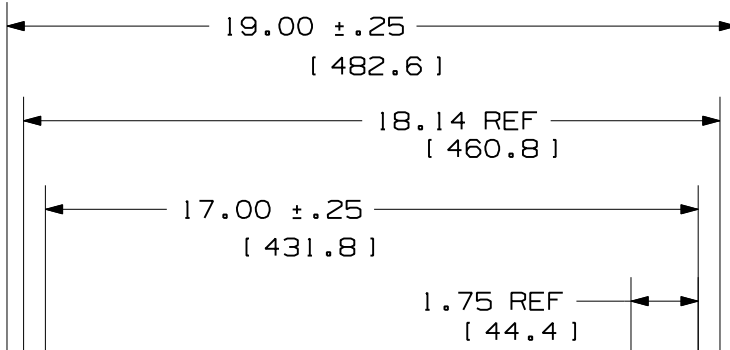

PANDUIT P/N	WEIGHT
CMRPSH20	06.0 LBS/EACH 2.7 Kg/EACH

- NOTES:
- IDENTIFICATION: 125 VOLT HORIZONTAL POWER STRIP WITH TEN, 20 AMP (REAR MOUNTED) OUTLETS.
  - ACCESSORY COMPONENTS:  
(4) #10-32 X 1/2" MOUNTING SCREWS  
(4) #12-24 X 1/2" MOUNTING SCREWS
  - THE POWER STRIP SHALL HAVE THE FOLLOWING:  
-TEN (10) - NEMA 5-20R OUTLETS (5 DUPLEX RECEPTACLES)  
-10 FOOT POWER CORD WITH NEMA 5-20P PLUG
  - DIMENSIONS IN PARENTHESES ARE METRIC [mm].

PART NO	COLOR
CMRPSH20	BLACK

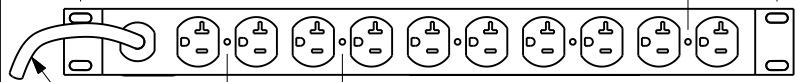

POWER CORD

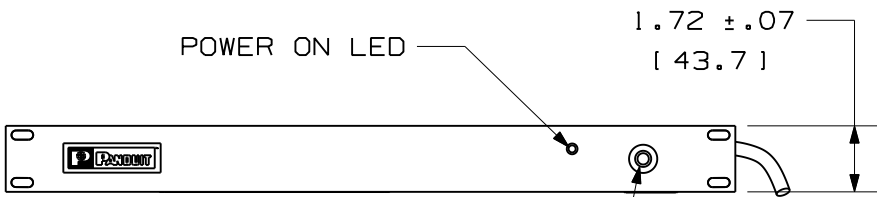

POWER ON LED

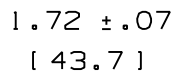

20 AMP THERMAL BREAKER RESET

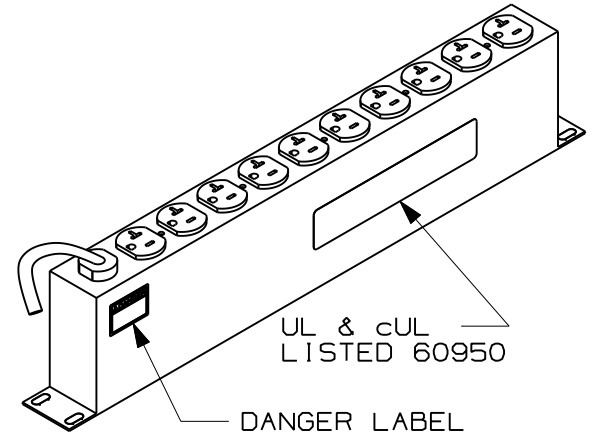
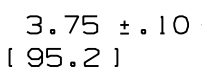
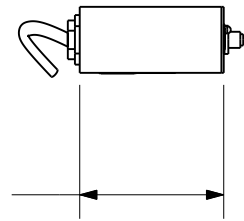

UL & cUL LISTED 60950

DANGER LABEL

MODEL FILENAME	V01129CB_CMRPSH20_00.PRT
CAD FILENAME/LAYERS	V01129CB_DC_00D.PRT

**PANDUIT** CORP. TINLEY PARK, ILLINOIS

1RU 19" HORIZONTAL POWER STRIP  
20 AMP 125V (CMRPSH20)  
CUSTOMER DRAWING

REV	DATE	BY	CHK	DESCRIPTION	ECN	R	CUST	SUP	OTH
---	---	---		K. UPDATED TITLE BLOCK J. ADDED WEIGHT BOX I. NOTE 3 WAS THE POWER STRIP SHALL HAVE THE FOLLOWING:-TEN (10) - NEMA 5-20R OUTLETS (5 DUPLEX 20 AMP RECEPTACLES) WITH NEMA 5-20P PLUG H. NOTE 4 WAS METRIC DIMENSIONS SHOWN IN BRACKETS ARE FOR REFERENCE ONLY (MM).	---				
OOD	5-4-09	MRWA		G. NOTE 3 WAS SEE SPEC. SHEET SA-NC10SPOIF FOR TECHNICAL SPECIFICATIONS. F. ADDED UL LABEL AND TEXT E. ADDED DANGER LABEL AND TEXT	01129-05				
OOC	4-22-02	MAV		B. REMOVED THUMB SCREWS W/RETAINING RINGS C. ADDED VOLTAGE TO NOTE #1 D. ADDED SPEC SHEET #	01129-05				
O0B	9-7-01	MAV	MJM	A. REVISED ACCESSORY COMPONENTS	01129-05		JWI		
O0A	7-24-01	JDWE	MJM	RELEASED TO PRODUCTION	01129-05		JWI		

UNLESS OTHERWISE SPECIFIED, DIMENSIONAL TOLERANCES ARE: (.X) ± (.XXX) ± (.XX) ± ANGLES ±		UNLESS OTHERWISE SPECIFIED, ALL DIMENSIONS ARE GIVEN IN INCHES, THIRD ANGLE PROJECTION.	
DRAWN BY JDWE	MAT'L: COLD-ROLLED STEEL	SCALE 1:5	DWG A SIZE
DATE 7-24-01	CHK'D MJM	DRAWING NO. 01129-05	

# Mouser Electronics

Authorized Distributor

Click to View Pricing, Inventory, Delivery & Lifecycle Information:

[Panduit:](#)

[CMRPSH20](#)