

## SN74LVC16374A 16-Bit Edge-Triggered D-Type Flip-Flop With 3-State Outputs

### 1 Features

- Member of the Texas Instruments Widebus™ Family
- Typical  $V_{OLP}$  (Output Ground Bounce)  $< 0.8$  V at  $V_{CC} = 3.3$  V,  $T_A = 25^\circ\text{C}$
- Typical  $V_{OHV}$  (Output  $V_{OH}$  Undershoot)  $> 2$  V at  $V_{CC} = 3.3$  V,  $T_A = 25^\circ\text{C}$
- $I_{off}$  Supports Live Insertion, Partial-Power-Down Mode, and Back-Drive Protection
- Supports Mixed-Mode Signal Operation on All Ports (5-V Input and Output Voltages With 3.3-V  $V_{CC}$ )
- Latch-Up Performance Exceeds 250 mA Per JESD 17
- ESD Protection Exceeds JESD 22
  - 2000-V Human-Body Model (A114-A)
  - 1000-V Charged-Device Model (C101)

### 2 Applications

- Servers
- PCs and Notebooks
- Network Switches
- Electronic Points of Sale

### 3 Description

This 16-bit edge-triggered D-type flip-flop is designed for 1.65-V to 3.6-V  $V_{CC}$  operation.

#### Device Information<sup>(1)</sup>

PART NUMBER	PACKAGE	BODY SIZE (NOM)
SN74LVC16374A	SSOP (48)	15.80 mm × 7.50 mm
	TSSOP (48)	12.50 mm × 6.10 mm
	TVSOP (48)	9.70 mm × 4.40 mm

(1) For all available packages, see the orderable addendum at the end of the data sheet.

### 4 Simplified Schematic

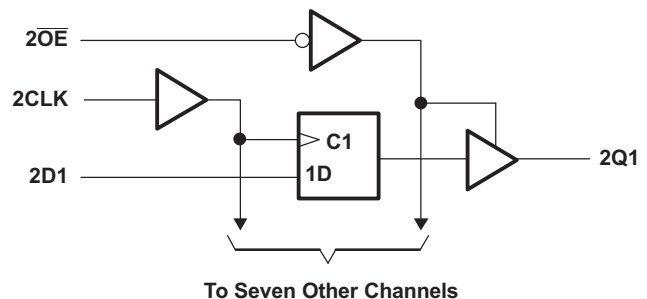
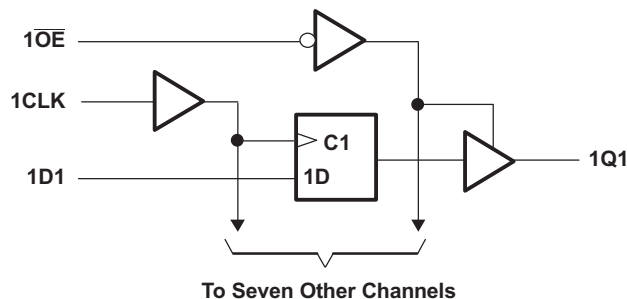

## Table of Contents

<b>1 Features</b> .....	<b>1</b>	<b>9 Detailed Description</b> .....	<b>11</b>
<b>2 Applications</b> .....	<b>1</b>	9.1 Overview .....	11
<b>3 Description</b> .....	<b>1</b>	9.2 Functional Block Diagram .....	11
<b>4 Simplified Schematic</b> .....	<b>1</b>	9.3 Feature Description .....	11
<b>5 Revision History</b> .....	<b>2</b>	9.4 Device Functional Modes .....	11
<b>6 Pin Configuration and Functions</b> .....	<b>3</b>	<b>10 Application and Implementation</b> .....	<b>12</b>
<b>7 Specifications</b> .....	<b>6</b>	10.1 Application Information .....	12
7.1 Absolute Maximum Ratings .....	6	10.2 Typical Application .....	12
7.2 Handling Ratings .....	6	<b>11 Power Supply Recommendations</b> .....	<b>13</b>
7.3 Recommended Operating Conditions .....	7	<b>12 Layout</b> .....	<b>13</b>
7.4 Thermal Information .....	7	12.1 Layout Guidelines .....	13
7.5 Electrical Characteristics .....	8	12.2 Layout Example .....	13
7.6 Timing Requirements .....	8	<b>13 Device and Documentation Support</b> .....	<b>14</b>
7.7 Switching Characteristics .....	8	13.1 Trademarks .....	14
7.8 Operating Characteristics .....	9	13.2 Electrostatic Discharge Caution .....	14
7.9 Typical Characteristics .....	9	13.3 Glossary .....	14
<b>8 Parameter Measurement Information</b> .....	<b>10</b>	<b>14 Mechanical, Packaging, and Orderable Information</b> .....	<b>14</b>

## 5 Revision History

### Changes from Revision A (October 2005) to Revision B

Page

• Updated document to new TI data sheet standards. ....	1
• Deleted Ordering Information table. ....	1
• Changed $I_{off}$ bullet in Features .....	1
• Added Applications .....	1
• Added Pin Functions table .....	3
• Added Handling Ratings table .....	6
• Changed MAX operating temperature to 125°C in Recommended Operating Conditions. ....	7
• Added Thermal Information table .....	7
• Added Typical Characteristics section .....	9
• Added Detailed Description section .....	11
• Added Application and Implementation section .....	12
• Added Power Supply Recommendations and Layout sections .....	13

## 6 Pin Configuration and Functions

**DGG, DGV, OR DL PACKAGE  
(TOP VIEW)**

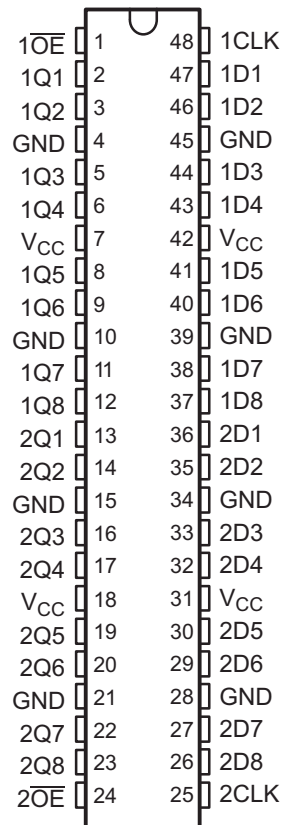

**Pin Functions**

PIN		I/O	DESCRIPTION
NO.	NAME		
1	$\overline{1OE}$	I	Output Enable 1
2	1Q1	O	1Q1 Output
3	1Q2	O	1Q2 Output
4	GND	—	Ground Pin
5	1Q3	O	1Q3 Output
6	1Q4	O	1Q4 Output
7	V <sub>CC</sub>	—	Power Pin
8	1Q5	O	1Q5 Output
9	1Q6	O	1Q6 Output
10	GND	—	Ground Pin
11	1Q7	O	1Q7 Output
12	1Q8	O	1Q8 Output
13	2Q1	O	2Q1 Output
14	2Q2	O	2Q2 Output
15	GND	—	Ground Pin
16	2Q3	O	2Q3 Output
17	2Q4	O	2Q4 Output
18	V <sub>CC</sub>	—	Power Pin

**Pin Functions (continued)**

PIN		I/O	DESCRIPTION
NO.	NAME		
19	2Q5	O	2Q5 Output
20	2Q6	O	2Q6 Output
21	GND	—	Ground Pin
22	2Q7	O	2Q7 Output
23	2Q8	O	2Q8 Output
24	2 $\overline{OE}$	O	Output Enable 2
25	2CLK	I	Clock 2
26	2D8	I	2D8 Input
27	2D7	I	2D7 Input
28	GND	—	Ground Pin
29	2D6	I	2D6 Input
30	2D5	I	2D5 Input
31	V <sub>CC</sub>	—	Power Pin
32	2D4	I	2D4 Input
33	2D3	I	2D3 Input
34	GND	—	Ground Pin
35	2D2	I	2D2 Input
36	2D1	I	2D1 Input
37	1D8	I	1D8 Input
38	1D7	I	1D7 Input
39	GND	—	Ground Pin
40	1D6	I	1D6 Input
41	1D5	I	1D5 Input
42	V <sub>CC</sub>	—	Power Pin
43	1D4	I	1D4 Input
44	1D3	I	1D3 Input
45	GND	—	Ground Pin
46	1D2	I	1D2 Input
47	1D1	I	1D1 Input
48	1CLK	I	Clock 1

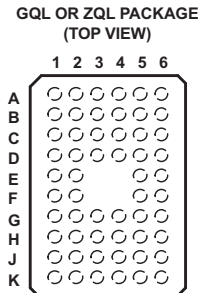

**Table 1. Pin Assignments<sup>(1)</sup>  
(56-Ball GQL or ZQL Package)**

	1	2	3	4	5	6
A	1 $\overline{OE}$	NC	NC	NC	NC	1CLK
B	1Q2	1Q1	GND	GND	1D1	1D2
C	1Q4	1Q3	V <sub>CC</sub>	V <sub>CC</sub>	1D3	1D4
D	1Q6	1Q5	GND	GND	1D5	1D6
E	1Q8	1Q7			1D7	1D8
F	2Q1	2Q2			2D2	2D1
G	2Q3	2Q4	GND	GND	2D4	2D3
H	2Q5	2Q6	V <sub>CC</sub>	V <sub>CC</sub>	2D6	2D5
J	2Q7	2Q8	GND	GND	2D8	2D7
K	2 $\overline{OE}$	NC	NC	NC	NC	2CLK

(1) NC – No internal connection

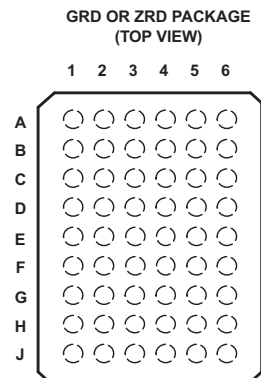

**Table 2. Pin Assignments<sup>(1)</sup>  
(54-Ball GRD or ZRD Package)**

	1	2	3	4	5	6
A	1Q1	NC	1 $\overline{OE}$	1CLK	NC	1D1
B	1Q3	1Q2	NC	NC	1D2	1D3
C	1Q5	1Q4	V <sub>CC</sub>	V <sub>CC</sub>	1D4	1D5
D	1Q7	1Q6	GND	GND	1D6	1D7
E	2Q1	1Q8	GND	GND	1D8	2D1
F	2Q3	2Q2	GND	GND	2D2	2D3
G	2Q5	2Q4	V <sub>CC</sub>	V <sub>CC</sub>	2D4	2D5
H	2Q7	2Q6	NC	NC	2D6	2D7
J	2Q8	NC	2 $\overline{OE}$	2CLK	NC	2D8

(1) NC – No internal connection

## 7 Specifications

### 7.1 Absolute Maximum Ratings

over operating free-air temperature range (unless otherwise noted)<sup>(1)</sup>

		MIN	MAX	UNIT
V <sub>CC</sub>	Supply voltage range	–0.5	6.5	V
V <sub>I</sub>	Input voltage range <sup>(2)</sup>	–0.5	6.5	V
V <sub>O</sub>	Voltage range applied to any output in the high-impedance or power-off state <sup>(2)</sup>	–0.5	6.5	V
V <sub>O</sub>	Voltage range applied to any output in the high or low state <sup>(2)</sup> <sup>(3)</sup>	–0.5	V <sub>CC</sub> + 0.5	V
I <sub>IK</sub>	Input clamp current	V <sub>I</sub> < 0	–50	mA
I <sub>OK</sub>	Output clamp current	V <sub>O</sub> < 0	–50	mA
I <sub>O</sub>	Continuous output current		±50	mA
	Continuous current through each V <sub>CC</sub> or GND		±100	mA

- (1) Stresses beyond those listed under *Absolute Maximum Ratings* may cause permanent damage to the device. These are stress ratings only, and functional operation of the device at these or any other conditions beyond those indicated under *Recommended Operating Conditions* is not implied. Exposure to absolute-maximum-rated conditions for extended periods may affect device reliability.
- (2) The input negative-voltage and output voltage ratings may be exceeded if the input and output current ratings are observed.
- (3) The value of V<sub>CC</sub> is provided in the recommended operating conditions table.

### 7.2 Handling Ratings

		MIN	MAX	UNIT	
T <sub>stg</sub>	Storage temperature range	–65	150	°C	
V <sub>(ESD)</sub>	Electrostatic discharge	Human body model (HBM), per ANSI/ESDA/JEDEC JS-001, all pins <sup>(1)</sup>	0	2000	V
		Charged device model (CDM), per JEDEC specification JESD22-C101, all pins <sup>(2)</sup>	0	1000	

- (1) JEDEC document JEP155 states that 500-V HBM allows safe manufacturing with a standard ESD control process.
- (2) JEDEC document JEP157 states that 250-V CDM allows safe manufacturing with a standard ESD control process.

### 7.3 Recommended Operating Conditions

 over operating free-air temperature range (unless otherwise noted)<sup>(1)</sup>

		MIN	MAX	UNIT	
V <sub>CC</sub>	Supply voltage	Operating	1.65	3.6	V
		Data retention only	1.5		
V <sub>IH</sub>	High-level input voltage	V <sub>CC</sub> = 1.65 V to 1.95 V	0.65 × V <sub>CC</sub>		V
		V <sub>CC</sub> = 2.3 V to 2.7 V	1.7		
		V <sub>CC</sub> = 2.7 V to 3.6 V	2		
V <sub>IL</sub>	Low-level input voltage	V <sub>CC</sub> = 1.65 V to 1.95 V		0.35 × V <sub>CC</sub>	V
		V <sub>CC</sub> = 2.3 V to 2.7 V		0.7	
		V <sub>CC</sub> = 2.7 V to 3.6 V		0.8	
V <sub>I</sub>	Input voltage	0	5.5	V	
V <sub>O</sub>	Output voltage	High or low state	0	V <sub>CC</sub>	V
		3-state	0	5.5	
I <sub>OH</sub>	High-level output current	V <sub>CC</sub> = 1.65 V		−4	mA
		V <sub>CC</sub> = 2.3 V		−8	
		V <sub>CC</sub> = 2.7 V		−12	
		V <sub>CC</sub> = 3 V		−24	
I <sub>OL</sub>	Low-level output current	V <sub>CC</sub> = 1.65 V		4	mA
		V <sub>CC</sub> = 2.3 V		8	
		V <sub>CC</sub> = 2.7 V		12	
		V <sub>CC</sub> = 3 V		24	
Δt/Δv	Input transition rise or fall rate		10	ns/V	
T <sub>A</sub>	Operating free-air temperature	−40	125	°C	

(1) All unused inputs of the device must be held at V<sub>CC</sub> or GND to ensure proper device operation. Refer to the TI application report, *Implications of Slow or Floating CMOS Inputs (SCBA004)*.

### 7.4 Thermal Information

THERMAL METRIC <sup>(1)</sup>		SN74LVC16374A			UNIT
		DL	DGV	DGG	
		48 PINS			
R <sub>θJA</sub>	Junction-to-ambient thermal resistance	68.4	78.4	64.3	°C/W
R <sub>θJC(top)</sub>	Junction-to-case (top) thermal resistance	34.7	30.7	17.6	
R <sub>θJB</sub>	Junction-to-board thermal resistance	41.0	41.8	31.5	
ψ <sub>JT</sub>	Junction-to-top characterization parameter	12.3	3.8	1.1	
ψ <sub>JB</sub>	Junction-to-board characterization parameter	40.4	41.3	31.2	
R <sub>θJC(bot)</sub>	Junction-to-case (bottom) thermal resistance	n/a	n/a	n/a	

(1) For more information about traditional and new thermal metrics, see the *IC Package Thermal Metrics* application report ([SPRA953](#)).

## 7.5 Electrical Characteristics

over recommended operating free-air temperature range (unless otherwise noted)

PARAMETER	TEST CONDITIONS	V <sub>CC</sub>	MIN	TYP <sup>(1)</sup>	MAX	UNIT	
V <sub>OH</sub>	I <sub>OH</sub> = -100 μA	1.65 V to 3.6 V	V <sub>CC</sub> - 0.2			V	
	I <sub>OH</sub> = -4 mA	1.65 V	1.2				
	I <sub>OH</sub> = -8 mA	2.3 V	1.7				
	I <sub>OH</sub> = -12 mA		2.7 V	2.2			
			3 V	2.4			
I <sub>OH</sub> = -24 mA	3 V	2.2					
V <sub>OL</sub>	I <sub>OL</sub> = 100 μA	1.65 V to 3.6 V	0.2			V	
	I <sub>OL</sub> = 4 mA	1.65 V	0.45				
	I <sub>OL</sub> = 8 mA	2.3 V	0.7				
	I <sub>OL</sub> = 12 mA	2.7 V	0.4				
	I <sub>OL</sub> = 24 mA	3 V	0.55				
I <sub>I</sub>	V <sub>I</sub> = 0 to 5.5 V	3.6 V	±5			μA	
I <sub>off</sub>	V <sub>I</sub> or V <sub>O</sub> = 5.5 V	0	±10			μA	
I <sub>OZ</sub>	V <sub>O</sub> = 0 to 5.5 V	3.6 V	±10			μA	
I <sub>CC</sub>	V <sub>I</sub> = V <sub>CC</sub> or GND	3.6 V	20			μA	
	3.6 V ≤ V <sub>I</sub> ≤ 5.5 V <sup>(2)</sup>		20				
ΔI <sub>CC</sub>	One input at V <sub>CC</sub> - 0.6 V, Other inputs at V <sub>CC</sub> or GND	2.7 V to 3.6 V	500			μA	
C <sub>i</sub>	V <sub>I</sub> = V <sub>CC</sub> or GND	3.3 V	5			pF	
C <sub>o</sub>	V <sub>O</sub> = V <sub>CC</sub> or GND	3.3 V	6.5			pF	

 (1) All typical values are at V<sub>CC</sub> = 3.3 V, T<sub>A</sub> = 25°C.

(2) This applies in the disabled state only.

## 7.6 Timing Requirements

 over recommended operating free-air temperature range (unless otherwise noted) (see [Figure 3](#))

		V <sub>CC</sub> = 1.8 V ± 0.15 V		V <sub>CC</sub> = 2.5 V ± 0.2 V		V <sub>CC</sub> = 2.7 V		V <sub>CC</sub> = 3.3 V ± 0.3 V		UNIT
		MIN	MAX	MIN	MAX	MIN	MAX	MIN	MAX	
f <sub>clock</sub>	Clock frequency	150		150		150		150		MHz
t <sub>w</sub>	Pulse duration, CLK high or low	3.3		3.3		3.3		3.3		ns
t <sub>su</sub>	Setup time, data before CLK↑	2.4		1.6		1.9		1.9		ns
t <sub>h</sub>	Hold time, data after CLK↑	0.8		1		1.1		1.9		ns

## 7.7 Switching Characteristics

 over recommended operating free-air temperature range (unless otherwise noted) (see [Figure 3](#))

PARAMETER	FROM (INPUT)	TO (OUTPUT)	V <sub>CC</sub> = 1.8 V ± 0.15 V		V <sub>CC</sub> = 2.5 V ± 0.2 V		V <sub>CC</sub> = 2.7 V		V <sub>CC</sub> = 3.3 V ± 0.3 V		UNIT
			MIN	MAX	MIN	MAX	MIN	MAX	MIN	MAX	
f <sub>max</sub>			150		150		150		150		MHz
t <sub>pd</sub>	CLK	Q	1	6.5	1	4.3	1	4.9	1.5	4.5	ns
t <sub>en</sub>	$\overline{OE}$	Q	1	6.7	1	4.7	1	5.3	1.5	4.6	ns
t <sub>dis</sub>	$\overline{OE}$	Q	1	10.7	1	5	1	6.1	1.5	5.5	ns
t <sub>sk(o)</sub>			1		1		1		1		ns



### 7.8 Operating Characteristics

T<sub>A</sub> = 25°C

PARAMETER		TEST CONDITIONS	V <sub>CC</sub> = 1.8 V	V <sub>CC</sub> = 2.5 V	V <sub>CC</sub> = 3.3 V	UNIT
			TYP	TYP	TYP	
C <sub>pd</sub>	Power dissipation capacitance per flip-flop	f = 10 MHz	47	52	58	pF
	Outputs enabled		21	23	24	
	Outputs disabled					

### 7.9 Typical Characteristics

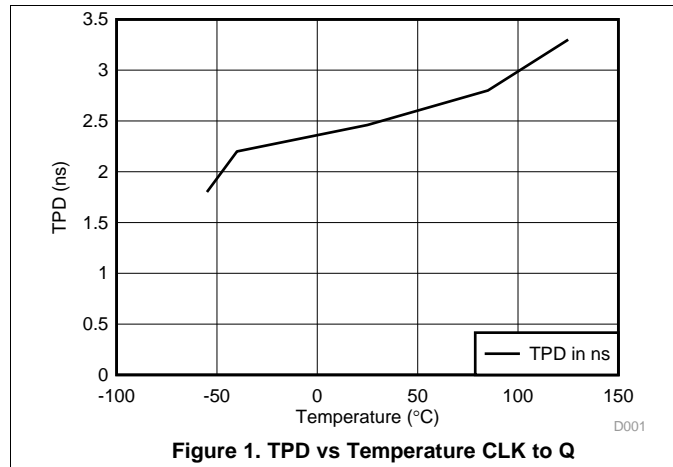

Figure 1. TPD vs Temperature CLK to Q

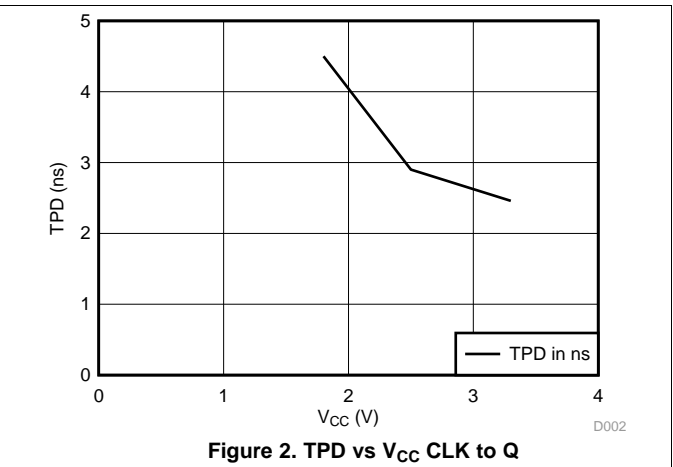
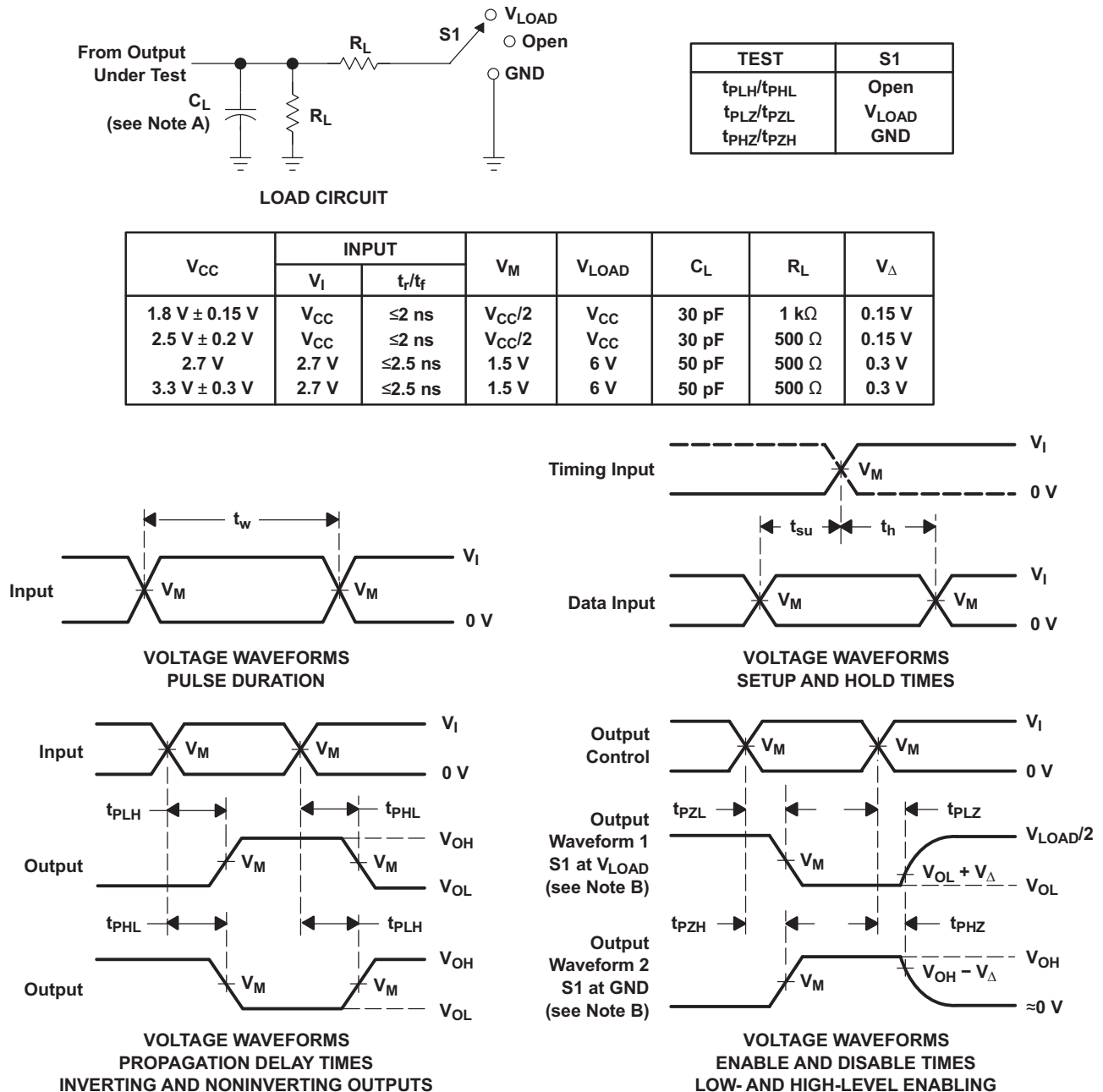

Figure 2. TPD vs V<sub>CC</sub> CLK to Q

## 8 Parameter Measurement Information



- NOTES:
- $C_L$  includes probe and jig capacitance.
  - Waveform 1 is for an output with internal conditions such that the output is low, except when disabled by the output control. Waveform 2 is for an output with internal conditions such that the output is high, except when disabled by the output control.
  - All input pulses are supplied by generators having the following characteristics: PRR  $\leq 10\text{ MHz}$ ,  $Z_O = 50\ \Omega$ .
  - The outputs are measured one at a time, with one transition per measurement.
  - $t_{PLZ}$  and  $t_{PHZ}$  are the same as  $t_{dis}$ .
  - $t_{PZL}$  and  $t_{PZH}$  are the same as  $t_{en}$ .
  - $t_{PLH}$  and  $t_{PHL}$  are the same as  $t_{pd}$ .
  - All parameters and waveforms are not applicable to all devices.

**Figure 3. Load Circuit and Voltage Waveforms**

## 9 Detailed Description

### 9.1 Overview

This 16-bit edge-triggered D-type flip-flop is designed for 1.65-V to 3.6-V  $V_{CC}$  operation.

The SN74LVC16374A device is particularly suitable for implementing buffer registers, I/O ports, bidirectional bus drivers, and working registers. The device can be used as two 8-bit flip-flops or one 16-bit flip-flop. On the positive transition of the clock (CLK) input, the Q outputs of the flip-flop take on the logic levels set up at the data (D) inputs.

A buffered output-enable ( $\overline{OE}$ ) input can be used to place the eight outputs in either a normal logic state (high or low logic levels) or the high-impedance state. In the high-impedance state, the outputs neither load nor drive the bus lines significantly. The high-impedance state and increased drive provide the capability to drive bus lines without interface or pull-up components.

$\overline{OE}$  does not affect internal operations of the flip-flop. Old data can be retained or new data can be entered while the outputs are in the high-impedance state.

To ensure the high-impedance state during power up or power down,  $\overline{OE}$  should be tied to  $V_{CC}$  through a pull-up resistor; the minimum value of the resistor is determined by the current-sinking capability of the driver.

Inputs can be driven from either 3.3-V or 5-V devices. This feature allows the use of this device as a translator in a mixed 3.3-V/5-V system environment.

This device is fully specified for partial-power-down applications using  $I_{off}$ . The  $I_{off}$  circuitry disables the outputs, preventing damaging current backflow through the device when it is powered down.

### 9.2 Functional Block Diagram

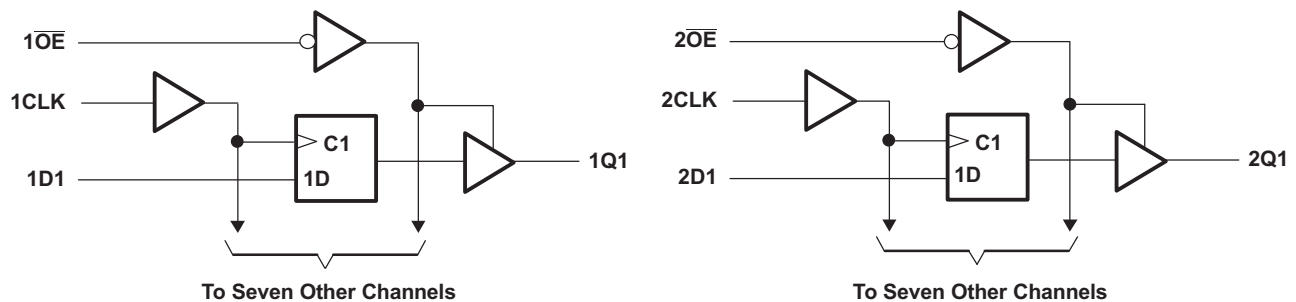

### 9.3 Feature Description

- Wide operating voltage range
  - Operates from 1.65 V to 3.6 V
- Allows down voltage translation
  - Inputs accept voltages to 5.5 V
- $I_{off}$  feature allows voltages on the inputs and outputs when  $V_{CC}$  is 0 V

### 9.4 Device Functional Modes

Table 3. Function Table  
(Each Flip-Flop)

INPUTS			OUTPUT
$\overline{OE}$	CLK	D	Q
L	↑	H	H
L	↑	L	L
L	H or L	X	$Q_0$
H	X	X	Z

## 10 Application and Implementation

### NOTE

Information in the following applications sections is not part of the TI component specification, and TI does not warrant its accuracy or completeness. TI's customers are responsible for determining suitability of components for their purposes. Customers should validate and test their design implementation to confirm system functionality.

### 10.1 Application Information

The SN74LVC16374A is a high-drive CMOS device that can be used for a multitude of bus interface type applications where the data needs to be retained or latched. It can produce 24 mA of drive current at 3.3 V; therefore, making it ideal for driving multiple outputs and good for high speed applications up to 150 MHz. The inputs are 5.5-V tolerant allowing the device to translate down to  $V_{CC}$ .

### 10.2 Typical Application

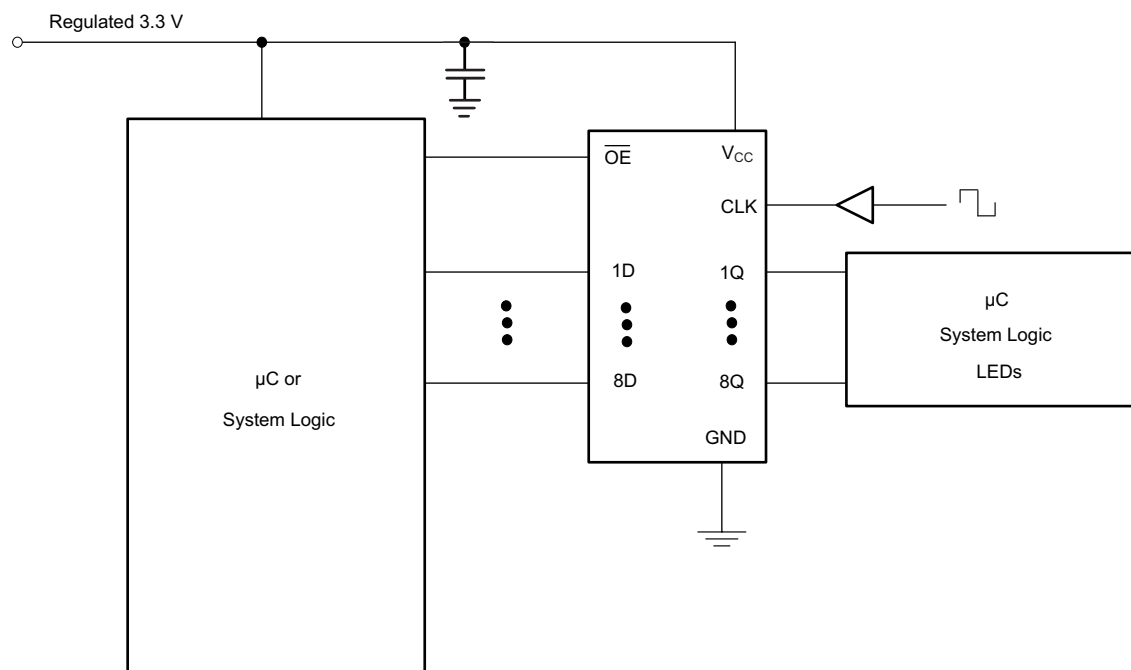

**Figure 4. Typical Application Diagram**

#### 10.2.1 Design Requirements

This device uses CMOS technology and has balanced output drive. Care should be taken to avoid bus contention because it can drive currents that would exceed maximum limits. The high drive will also create fast edges into light loads, so routing and load conditions should be considered to prevent ringing.

#### 10.2.2 Detailed Design Procedure

1. Recommended input conditions
  - Rise time and fall time specs: See  $(\Delta t/\Delta V)$  in the [Recommended Operating Conditions](#) table.
  - Specified High and low levels: See  $(V_{IH}$  and  $V_{IL})$  in the [Recommended Operating Conditions](#) table.
  - Inputs are overvoltage tolerant allowing them to go as high as 5.5 V at any valid  $V_{CC}$ .
2. Recommend output conditions
  - Load currents should not exceed 50 mA per output and 100 mA total for the part.
  - Outputs should not be pulled above  $V_{CC}$ .

## Typical Application (continued)

### 10.2.3 Application Curves

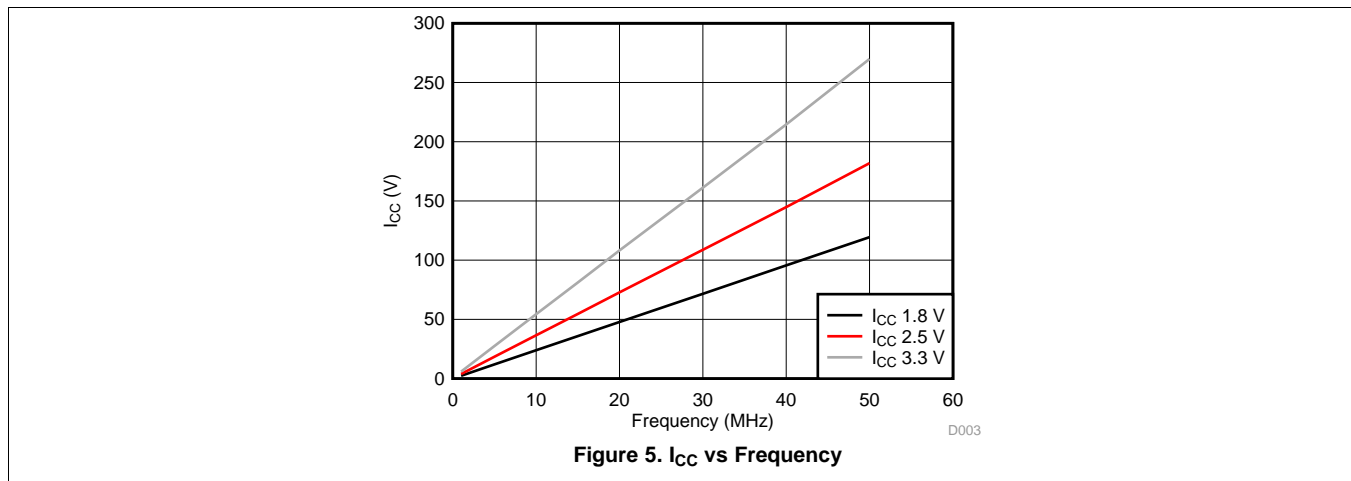

## 11 Power Supply Recommendations

The power supply can be any voltage between the MIN and MAX supply voltage rating located in the [Recommended Operating Conditions](#) table.

Each  $V_{CC}$  pin should have a good bypass capacitor to prevent power disturbance. For devices with a single supply, 0.1  $\mu$ F bypass capacitor is recommended. If there are multiple  $V_{CC}$  pins, 0.01  $\mu$ F or 0.022  $\mu$ F is recommended for each power pin. It is acceptable to parallel multiple bypass capacitors to reject different frequencies of noise. A 0.1  $\mu$ F and 1  $\mu$ F are commonly used in parallel. The bypass capacitor should be installed as close to the power pin as possible for best results.

## 12 Layout

### 12.1 Layout Guidelines

When using multiple bit logic devices inputs should not ever float.

In many cases, functions or parts of functions of digital logic devices are unused, for example, when only two inputs of a triple-input AND gate are used or only 3 of the 4 buffer gates are used. Such input pins should not be left unconnected because the undefined voltages at the outside connections result in undefined operational states. Specified in [Figure 6](#) are the rules that must be observed under all circumstances. All unused inputs of digital logic devices must be connected to a high or low bias to prevent them from floating. The logic level that should be applied to any particular unused input depends on the function of the device. Generally they will be tied to GND or  $V_{CC}$ ; whichever makes more sense or is more convenient. It is generally acceptable to float outputs unless the part is a transceiver.

### 12.2 Layout Example

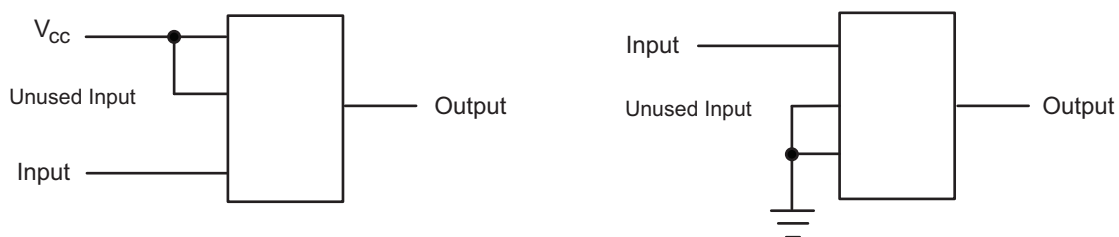

Figure 6. Layout Diagram

## 13 Device and Documentation Support

### 13.1 Trademarks

Widebus is a trademark of Texas Instruments.  
All other trademarks are the property of their respective owners.

### 13.2 Electrostatic Discharge Caution



These devices have limited built-in ESD protection. The leads should be shorted together or the device placed in conductive foam during storage or handling to prevent electrostatic damage to the MOS gates.

### 13.3 Glossary

[SLYZ022](#) — *TI Glossary*.

This glossary lists and explains terms, acronyms, and definitions.

## 14 Mechanical, Packaging, and Orderable Information

The following pages include mechanical, packaging, and orderable information. This information is the most current data available for the designated devices. This data is subject to change without notice and revision of this document. For browser-based versions of this data sheet, refer to the left-hand navigation.

**PACKAGING INFORMATION**

Orderable Device	Status (1)	Package Type	Package Drawing	Pins	Package Qty	Eco Plan (2)	Lead/Ball Finish (6)	MSL Peak Temp (3)	Op Temp (°C)	Device Marking (4/5)	Samples
SN74LVC16374ADGGR	ACTIVE	TSSOP	DGG	48	2000	Green (RoHS & no Sb/Br)	NIPDAU	Level-1-260C-UNLIM	-40 to 125	LVC16374A	<a href="#">Samples</a>
SN74LVC16374ADGVR	ACTIVE	TVSOP	DGV	48	2000	Green (RoHS & no Sb/Br)	NIPDAU	Level-1-260C-UNLIM	-40 to 125	LD374A	<a href="#">Samples</a>
SN74LVC16374ADL	ACTIVE	SSOP	DL	48	25	Green (RoHS & no Sb/Br)	NIPDAU	Level-1-260C-UNLIM	-40 to 125	LVC16374A	<a href="#">Samples</a>
SN74LVC16374ADLR	ACTIVE	SSOP	DL	48	1000	Green (RoHS & no Sb/Br)	NIPDAU	Level-1-260C-UNLIM	-40 to 125	LVC16374A	<a href="#">Samples</a>
SN74LVC16374AZQLR	LIFEBUY	BGA MICROSTAR JUNIOR	ZQL	56	1000	Green (RoHS & no Sb/Br)	SNAGCU	Level-1-260C-UNLIM	-40 to 85	LD374A	
SN74LVC16374AZRDR	LIFEBUY	BGA MICROSTAR JUNIOR	ZRD	54	1000	Green (RoHS & no Sb/Br)	SNAGCU	Level-1-260C-UNLIM	-40 to 85	LD374A	

(1) The marketing status values are defined as follows:

**ACTIVE:** Product device recommended for new designs.

**LIFEBUY:** TI has announced that the device will be discontinued, and a lifetime-buy period is in effect.

**NRND:** Not recommended for new designs. Device is in production to support existing customers, but TI does not recommend using this part in a new design.

**PREVIEW:** Device has been announced but is not in production. Samples may or may not be available.

**OBSOLETE:** TI has discontinued the production of the device.

(2) **RoHS:** TI defines "RoHS" to mean semiconductor products that are compliant with the current EU RoHS requirements for all 10 RoHS substances, including the requirement that RoHS substance do not exceed 0.1% by weight in homogeneous materials. Where designed to be soldered at high temperatures, "RoHS" products are suitable for use in specified lead-free processes. TI may reference these types of products as "Pb-Free".

**RoHS Exempt:** TI defines "RoHS Exempt" to mean products that contain lead but are compliant with EU RoHS pursuant to a specific EU RoHS exemption.

**Green:** TI defines "Green" to mean the content of Chlorine (Cl) and Bromine (Br) based flame retardants meet JS709B low halogen requirements of <=1000ppm threshold. Antimony trioxide based flame retardants must also meet the <=1000ppm threshold requirement.

(3) MSL, Peak Temp. - The Moisture Sensitivity Level rating according to the JEDEC industry standard classifications, and peak solder temperature.

(4) There may be additional marking, which relates to the logo, the lot trace code information, or the environmental category on the device.

(5) Multiple Device Markings will be inside parentheses. Only one Device Marking contained in parentheses and separated by a "~" will appear on a device. If a line is indented then it is a continuation of the previous line and the two combined represent the entire Device Marking for that device.

<sup>(6)</sup> Lead/Ball Finish - Orderable Devices may have multiple material finish options. Finish options are separated by a vertical ruled line. Lead/Ball Finish values may wrap to two lines if the finish value exceeds the maximum column width.

**Important Information and Disclaimer:** The information provided on this page represents TI's knowledge and belief as of the date that it is provided. TI bases its knowledge and belief on information provided by third parties, and makes no representation or warranty as to the accuracy of such information. Efforts are underway to better integrate information from third parties. TI has taken and continues to take reasonable steps to provide representative and accurate information but may not have conducted destructive testing or chemical analysis on incoming materials and chemicals. TI and TI suppliers consider certain information to be proprietary, and thus CAS numbers and other limited information may not be available for release.

In no event shall TI's liability arising out of such information exceed the total purchase price of the TI part(s) at issue in this document sold by TI to Customer on an annual basis.



**TAPE AND REEL INFORMATION**

**QUADRANT ASSIGNMENTS FOR PIN 1 ORIENTATION IN TAPE**

\*All dimensions are nominal

Device	Package Type	Package Drawing	Pins	SPQ	Reel Diameter (mm)	Reel Width W1 (mm)	A0 (mm)	B0 (mm)	K0 (mm)	P1 (mm)	W (mm)	Pin1 Quadrant
SN74LVC16374ADGGR	TSSOP	DGG	48	2000	330.0	24.4	8.6	13.0	1.8	12.0	24.0	Q1
SN74LVC16374ADGVR	TVSOP	DGV	48	2000	330.0	16.4	7.1	10.2	1.6	12.0	16.0	Q1
SN74LVC16374ADLR	SSOP	DL	48	1000	330.0	32.4	11.35	16.2	3.1	16.0	32.0	Q1
SN74LVC16374AZQLR	BGA MICROSTAR JUNIOR	ZQL	56	1000	330.0	16.4	4.8	7.3	1.5	8.0	16.0	Q1
SN74LVC16374AZRDR	BGA MICROSTAR JUNIOR	ZRD	54	1000	330.0	16.4	5.8	8.3	1.55	8.0	16.0	Q1

**TAPE AND REEL BOX DIMENSIONS**



\*All dimensions are nominal

Device	Package Type	Package Drawing	Pins	SPQ	Length (mm)	Width (mm)	Height (mm)
SN74LVC16374ADGGR	TSSOP	DGG	48	2000	367.0	367.0	45.0
SN74LVC16374ADGVR	TVSOP	DGV	48	2000	367.0	367.0	38.0
SN74LVC16374ADLR	SSOP	DL	48	1000	367.0	367.0	55.0
SN74LVC16374AZQLR	BGA MICROSTAR JUNIOR	ZQL	56	1000	350.0	350.0	43.0
SN74LVC16374AZRDR	BGA MICROSTAR JUNIOR	ZRD	54	1000	350.0	350.0	43.0

ZRD (R-PBGA-N54)

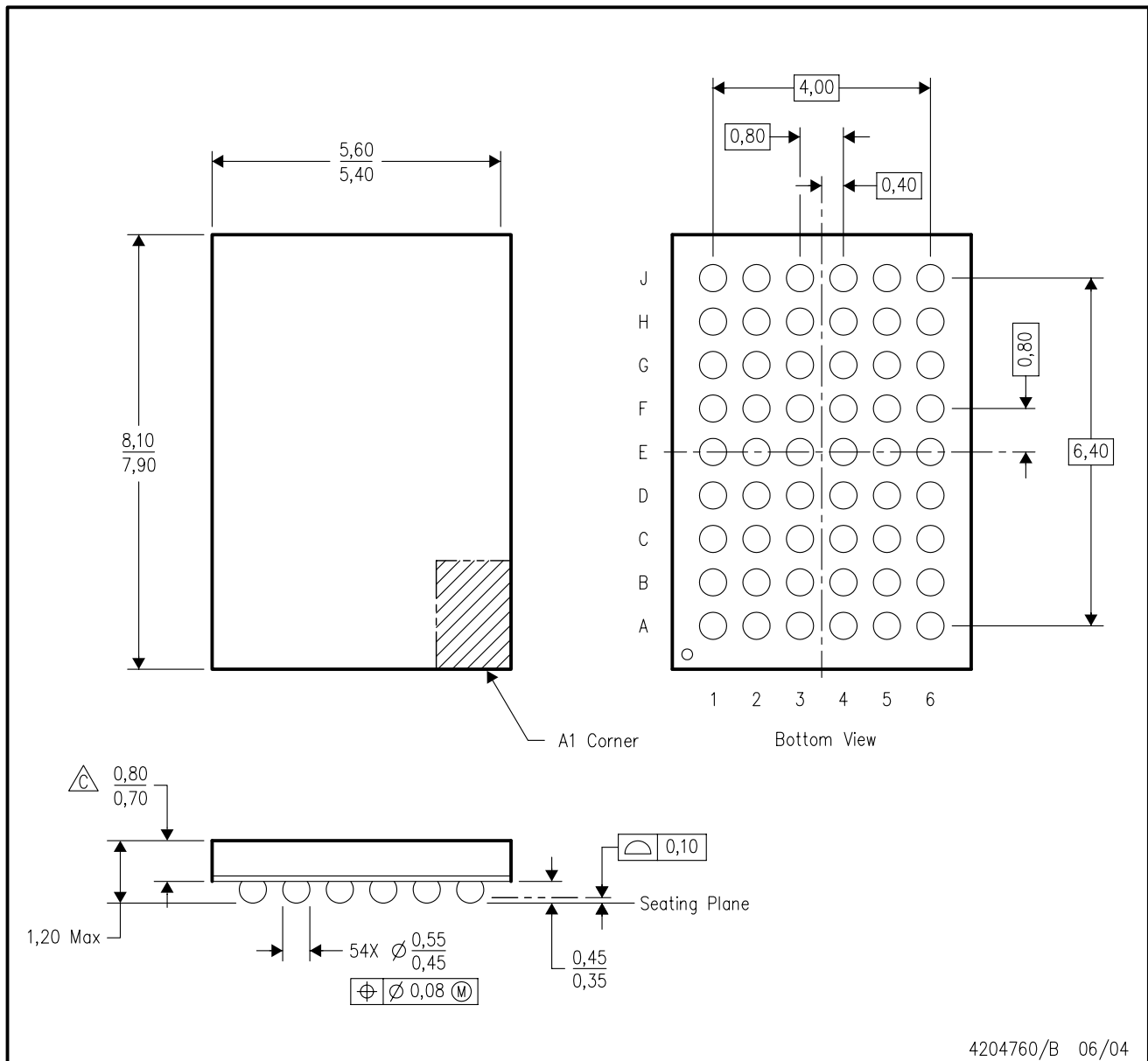
PLASTIC BALL GRID ARRAY



- NOTES:
- A. All linear dimensions are in millimeters.
  - B. This drawing is subject to change without notice.
  -  Falls within JEDEC MO-205 variation DD.
  - D. This package is lead-free. Refer to the 54 GRD package (drawing 4204759) for tin-lead (SnPb).

# MECHANICAL DATA

DL (R-PDSO-G48)

PLASTIC SMALL-OUTLINE PACKAGE



- NOTES:
- All linear dimensions are in inches (millimeters).
  - This drawing is subject to change without notice.
  - Body dimensions do not include mold flash or protrusion not to exceed 0.006 (0,15).
  - Falls within JEDEC MO-118

PowerPAD is a trademark of Texas Instruments.

DGV (R-PDSO-G\*\*)

PLASTIC SMALL-OUTLINE

24 PINS SHOWN



- NOTES: A. All linear dimensions are in millimeters.  
 B. This drawing is subject to change without notice.  
 C. Body dimensions do not include mold flash or protrusion, not to exceed 0,15 per side.  
 D. Falls within JEDEC: 24/48 Pins – MO-153  
 14/16/20/56 Pins – MO-194

DGG (R-PDSO-G\*\*)

PLASTIC SMALL-OUTLINE PACKAGE

48 PINS SHOWN



- NOTES: A. All linear dimensions are in millimeters.  
 B. This drawing is subject to change without notice.  
 C. Body dimensions do not include mold protrusion not to exceed 0,15.  
 D. Falls within JEDEC MO-153

ZQL0056A

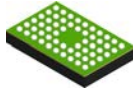

# PACKAGE OUTLINE

JRBGA - 1 mm max height

PLASTIC BALL GRID ARRAY

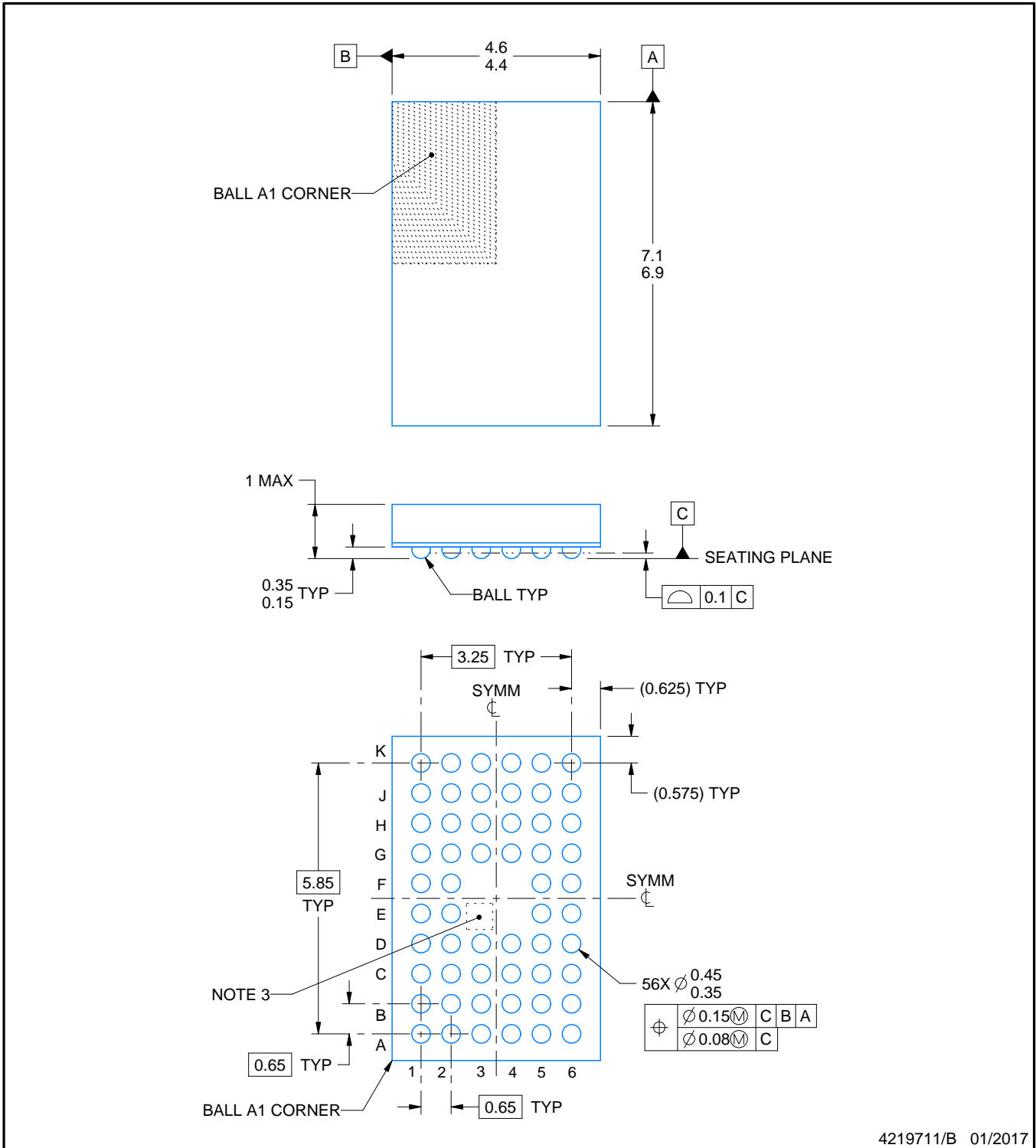

4219711/B 01/2017

**NOTES:**

1. All linear dimensions are in millimeters. Any dimensions in parenthesis are for reference only. Dimensioning and tolerancing per ASME Y14.5M.
2. This drawing is subject to change without notice.
3. No metal in this area, indicates orientation.

# EXAMPLE BOARD LAYOUT

ZQL0056A

JRBGA - 1 mm max height

PLASTIC BALL GRID ARRAY

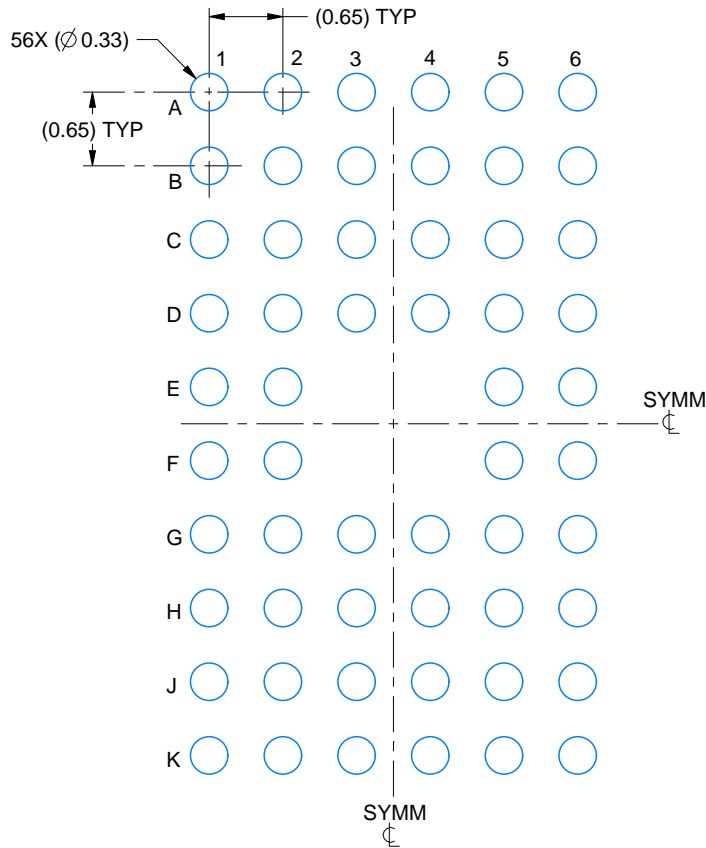

LAND PATTERN EXAMPLE  
EXPOSED METAL SHOWN  
SCALE:15X

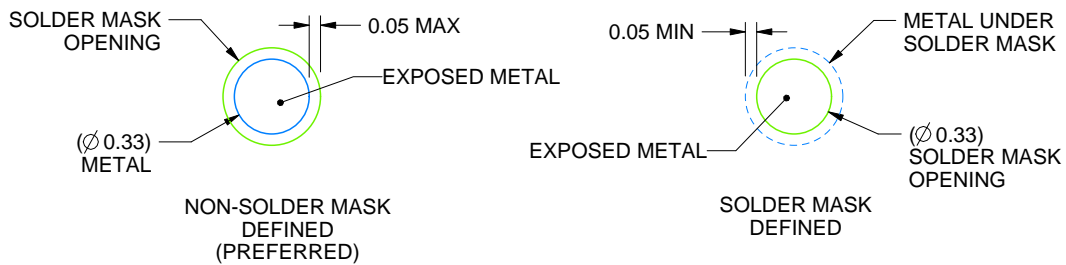

SOLDER MASK DETAILS  
NOT TO SCALE

4219711/B 01/2017

NOTES: (continued)

- Final dimensions may vary due to manufacturing tolerance considerations and also routing constraints. For information, see Texas Instruments literature number SPRAA99 ([www.ti.com/lit/spraa99](http://www.ti.com/lit/spraa99)).



# EXAMPLE STENCIL DESIGN

ZQL0056A

JRBGA - 1 mm max height

PLASTIC BALL GRID ARRAY

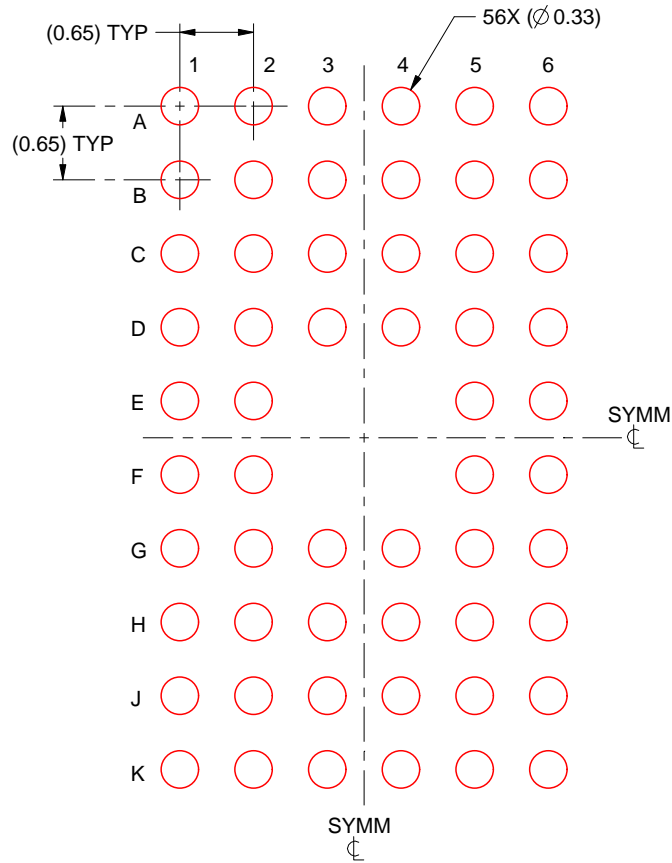

SOLDER PASTE EXAMPLE  
BASED ON 0.125 mm THICK STENCIL  
SCALE:15X

4219711/B 01/2017

NOTES: (continued)

5. Laser cutting apertures with trapezoidal walls and rounded corners may offer better paste release.

## IMPORTANT NOTICE AND DISCLAIMER

TI PROVIDES TECHNICAL AND RELIABILITY DATA (INCLUDING DATASHEETS), DESIGN RESOURCES (INCLUDING REFERENCE DESIGNS), APPLICATION OR OTHER DESIGN ADVICE, WEB TOOLS, SAFETY INFORMATION, AND OTHER RESOURCES "AS IS" AND WITH ALL FAULTS, AND DISCLAIMS ALL WARRANTIES, EXPRESS AND IMPLIED, INCLUDING WITHOUT LIMITATION ANY IMPLIED WARRANTIES OF MERCHANTABILITY, FITNESS FOR A PARTICULAR PURPOSE OR NON-INFRINGEMENT OF THIRD PARTY INTELLECTUAL PROPERTY RIGHTS.

These resources are intended for skilled developers designing with TI products. You are solely responsible for (1) selecting the appropriate TI products for your application, (2) designing, validating and testing your application, and (3) ensuring your application meets applicable standards, and any other safety, security, or other requirements. These resources are subject to change without notice. TI grants you permission to use these resources only for development of an application that uses the TI products described in the resource. Other reproduction and display of these resources is prohibited. No license is granted to any other TI intellectual property right or to any third party intellectual property right. TI disclaims responsibility for, and you will fully indemnify TI and its representatives against, any claims, damages, costs, losses, and liabilities arising out of your use of these resources.

TI's products are provided subject to TI's Terms of Sale ([www.ti.com/legal/termsofsale.html](http://www.ti.com/legal/termsofsale.html)) or other applicable terms available either on [ti.com](http://ti.com) or provided in conjunction with such TI products. TI's provision of these resources does not expand or otherwise alter TI's applicable warranties or warranty disclaimers for TI products.

Mailing Address: Texas Instruments, Post Office Box 655303, Dallas, Texas 75265  
Copyright © 2020, Texas Instruments Incorporated