

High Voltage IGBT

IXGH 32N170A
IXGT 32N170A

$V_{CES} = 1700 \text{ V}$
 $I_{C25} = 32 \text{ A}$
 $V_{CE(sat)} = 5.0 \text{ V}$
 $t_{fi(typ)} = 50 \text{ ns}$

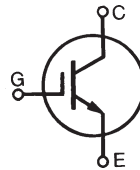

Symbol	Test Conditions	Maximum Ratings	
V_{CES}	$T_J = 25^\circ\text{C to } 150^\circ\text{C}$	1700	V
V_{CGR}	$T_J = 25^\circ\text{C to } 150^\circ\text{C}; R_{GE} = 1 \text{ M}\Omega$	1700	V
V_{GES}	Continuous	± 20	V
V_{GEM}	Transient	± 30	V
I_{C25}	$T_C = 25^\circ\text{C}$	32	A
I_{C90}	$T_C = 90^\circ\text{C}$	21	A
I_{CM}	$T_C = 25^\circ\text{C}, 1 \text{ ms}$	110	A
SSOA (RBSOA)	$V_{GE} = 15 \text{ V}, T_{VJ} = 125^\circ\text{C}, R_G = 5\Omega$ Clamped inductive load	$I_{CM} = 70$ @ $0.8 V_{CES}$	A
t_{SC}	$T_J = 125^\circ\text{C}, V_{CE} = 1200 \text{ V}; V_{GE} = 15 \text{ V}, R_G = 10\Omega$	10	μs
P_C	$T_C = 25^\circ\text{C}$	350	W
T_J		-55 ... +150	$^\circ\text{C}$
T_{JM}		150	$^\circ\text{C}$
T_{stg}		-55 ... +150	$^\circ\text{C}$
M_d	Mounting torque (M3) (TO-247)	1.13/10Nm/lb.in.	
Maximum lead temperature for soldering 1.6 mm (0.062 in.) from case for 10 s		300	$^\circ\text{C}$
Weight		TO-247 TO-268	6 4 g

TO-268 (IXGT)

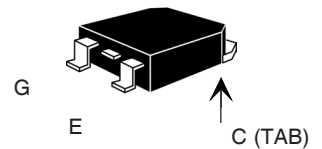

TO-247 AD (IXGH)

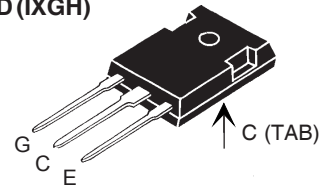

G = Gate, C = Collector,
E = Emitter, TAB = Collector

Features

- International standard packages JEDEC TO-268 and JEDEC TO-247 AD
- High current handling capability
- MOS Gate turn-on - drive simplicity
- Rugged NPT structure
- Molding epoxies meet UL 94 V-0 flammability classification

Applications

- Capacitor discharge & pulser circuits
- AC motor speed control
- DC servo and robot drives
- DC choppers
- Uninterruptible power supplies (UPS)
- Switched-mode and resonant-mode power supplies

Advantages

- High power density
- Suitable for surface mounting
- Easy to mount with 1 screw, (isolated mounting screw hole)

Symbol	Test Conditions	Characteristic Values ($T_J = 25^\circ\text{C}$, unless otherwise specified)		
		min.	typ.	max.
BV_{CES}	$I_C = 250 \mu\text{A}, V_{GE} = 0 \text{ V}$	1700		V
$V_{GE(th)}$	$I_C = 250 \mu\text{A}, V_{CE} = V_{GE}$	3.0		V
I_{CES}	$V_{CE} = 0.8 \cdot V_{CES}$ $V_{GE} = 0 \text{ V}$		$T_J = 25^\circ\text{C}$ $T_J = 125^\circ\text{C}$ Note 1	50 μA 2 mA
I_{GES}	$V_{CE} = 0 \text{ V}, V_{GE} = \pm 20 \text{ V}$			$\pm 100 \text{ nA}$
$V_{CE(sat)}$	$I_C = I_{C90}, V_{GE} = 15 \text{ V}$	$T_J = 25^\circ\text{C}$ $T_J = 125^\circ\text{C}$	4.0 4.8	V V

Symbol	Test Conditions	Characteristic Values ($T_J = 25^\circ\text{C}$, unless otherwise specified)			
		min.	typ.	max.	
g_{fs}	$I_C = I_{90}$; $V_{CE} = 10\text{ V}$ Note 2	16	26	S	
C_{ies}	$V_{CE} = 25\text{ V}$, $V_{GE} = 0\text{ V}$, $f = 1\text{ MHz}$		3700	pF	
C_{oes}			180	pF	
C_{res}			43	pF	
Q_g	$I_C = I_{C90}$, $V_{GE} = 15\text{ V}$, $V_{CE} = 0.5 V_{CES}$		155	nC	
Q_{ge}			28	nC	
Q_{gc}			49	nC	
$t_{d(on)}$	Inductive load, $T_J = 25^\circ\text{C}$ $I_C = I_{C25}$, $V_{GE} = 15\text{ V}$ $R_G = 2.7\ \Omega$, $V_{CE} = 0.5 V_{CES}$ Note 3		46	ns	
t_{ri}			57	ns	
$t_{d(off)}$			260	500	ns
t_{fi}			50	100	ns
E_{off}			1.5	2.6	mJ
$t_{d(on)}$	Inductive load, $T_J = 125^\circ\text{C}$ $I_C = I_{C25}$, $V_{GE} = 15\text{ V}$ $R_G = 2.7\ \Omega$, $V_{CE} = 0.5 V_{CES}$ Note 3		48	ns	
t_{ri}			59	ns	
E_{on}			4.0	mJ	
$t_{d(off)}$			300	ns	
t_{fi}			70	ns	
E_{off}		2.4	mJ		
R_{thJC}	(TO-247)			0.35 K/W	
R_{thCK}			0.25	K/W	

- Notes: 1. Device must be heatsunk for high temperature leakage current measurements to avoid thermal runaway.
2. Pulse test, $t \leq 300\ \mu\text{s}$, duty cycle $\leq 2\%$
3. Switching times may increase for V_{CE} (Clamp) $> 0.8 \cdot V_{CES}$, higher T_J or increased R_G .

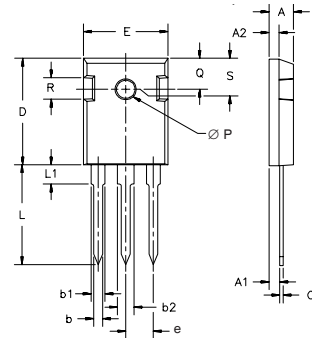
TO-247 AD Outline

Dim.	Millimeter		Inches	
	Min.	Max.	Min.	Max.
A	4.7	5.3	.185	.209
A ₁	2.2	2.54	.087	.102
A ₂	2.2	2.6	.059	.098
b	1.0	1.4	.040	.055
b ₁	1.65	2.13	.065	.084
b ₂	2.87	3.12	.113	.123
C	.4	.8	.016	.031
D	20.80	21.46	.819	.845
E	15.75	16.26	.610	.640
e	5.20	5.72	0.205	0.225
L	19.81	20.32	.780	.800
L ₁		4.50		.177
∅P	3.55	3.65	.140	.144
Q	5.89	6.40	0.232	0.252
R	4.32	5.49	.170	.216
S	6.15	BSC	.242	BSC

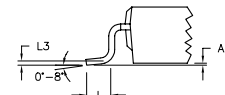
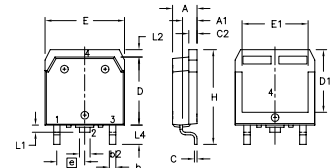
TO-268 Outline

Dim.	Millimeter		Inches	
	Min.	Max.	Min.	Max.
A	4.9	5.1	.193	.201
A ₁	2.7	2.9	.106	.114
A ₂	.02	.25	.001	.010
b	1.15	1.45	.045	.057
b ₂	1.9	2.1	.75	.83
C	.4	.65	.016	.026
D	13.80	14.00	.543	.551
E	15.85	16.05	.624	.632
E ₁	13.3	13.6	.524	.535
e	5.45	BSC	.215	BSC
H	18.70	19.10	.736	.752
L	2.40	2.70	.094	.106
L ₁	1.20	1.40	.047	.055
L ₂	1.00	1.15	.039	.045
L ₃		0.25		.010
L ₄	3.80	4.10	.150	.161

IXYS reserves the right to change limits, test conditions, and dimensions.

IXYS MOSFETs and IGBTs are covered by one or more of the following U.S. patents:	4,835,592	4,931,844	5,049,961	5,237,481	6,162,665	6,404,065B1	6,683,344	6,727,585
	4,850,072	5,017,508	5,063,307	5,381,025	6,259,123B1	6,534,343	6,710,405B2	6,759,692
	4,881,106	5,034,796	5,187,117	5,486,715	6,306,728 B1	6,583,505	6,710,463	

Fig. 1. Output Characteristics @ 25 Deg. C

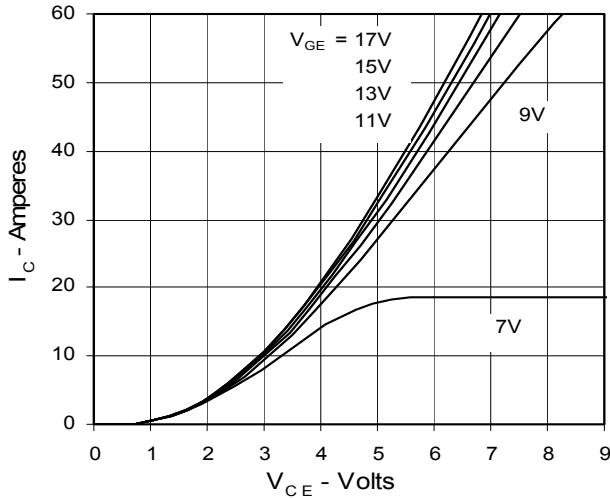

Fig. 2. Extended Output Characteristics @ 25 deg. C

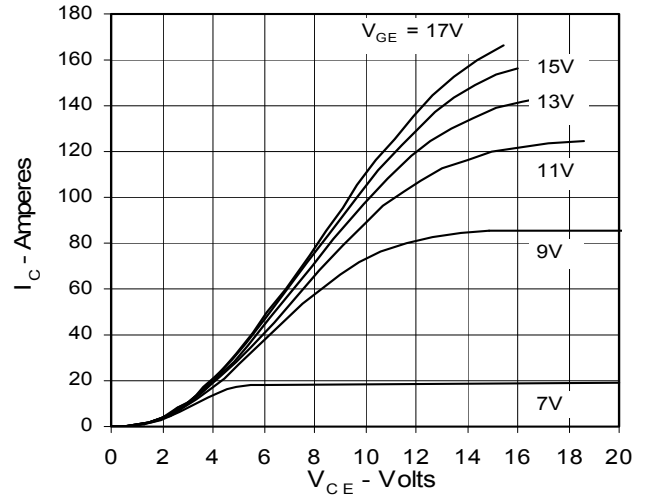

Fig. 3. Output Characteristics @ 125 Deg. C

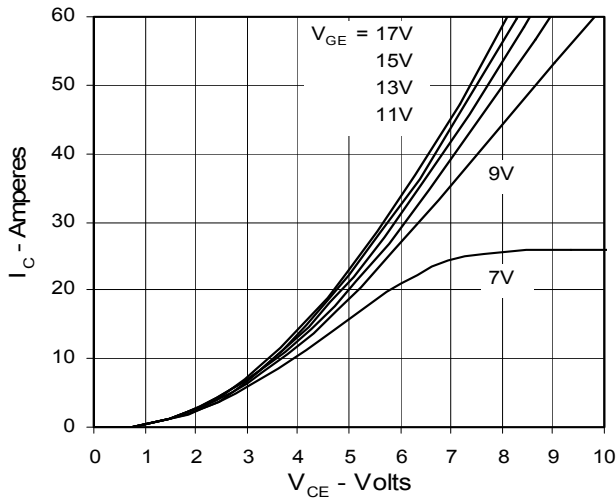

Fig. 4. Dependence of $V_{CE(sat)}$ on Temperature

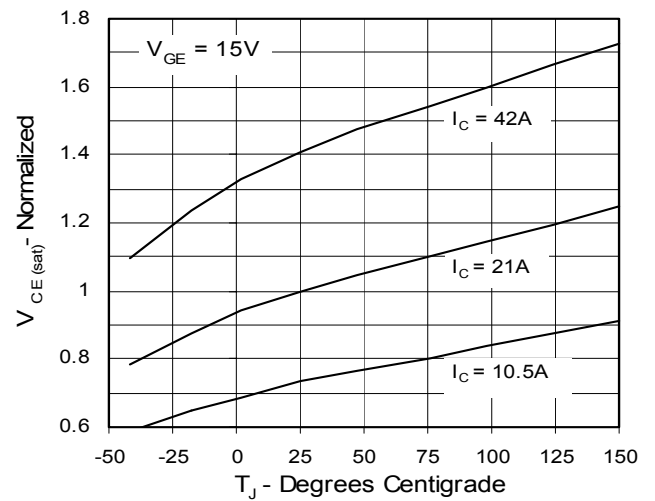

Fig. 5. Collector-to-Emitter Voltage vs. Gate-to-Emitter voltage

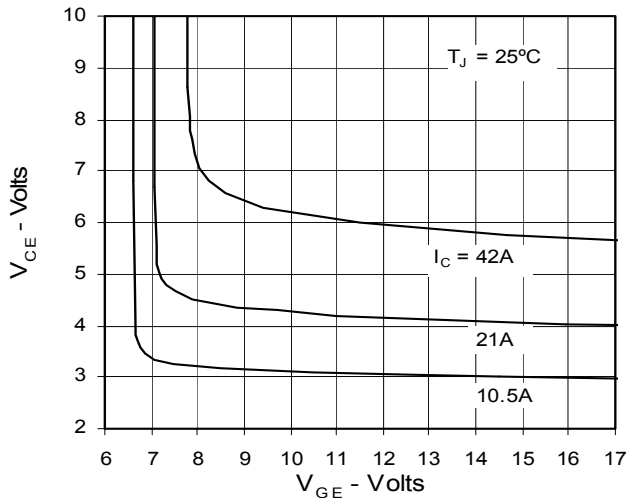

Fig. 6. Input Admittance

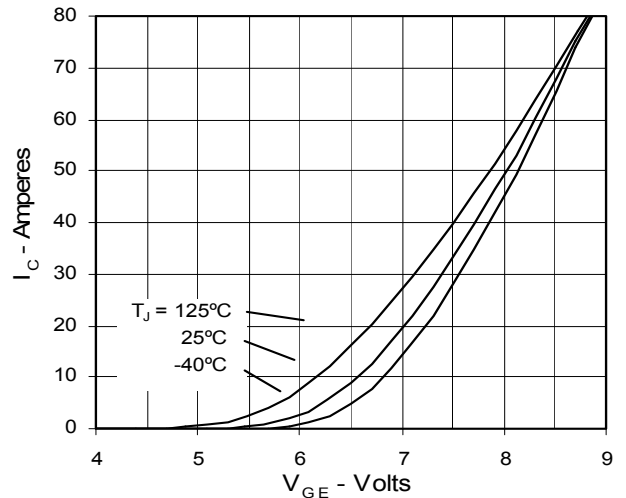

Fig. 7. Transconductance

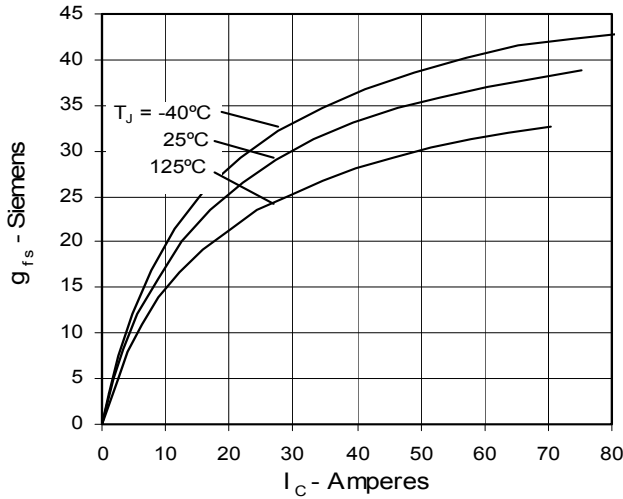

Fig. 8. Dependence of E_{off} on R_G

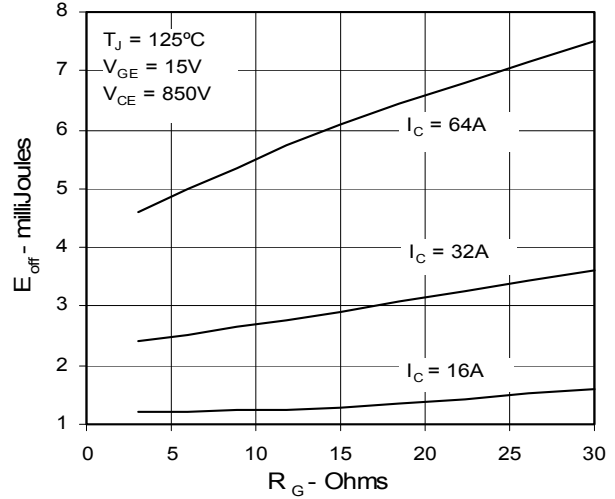

Fig. 9. Dependence of E_{off} on I_C

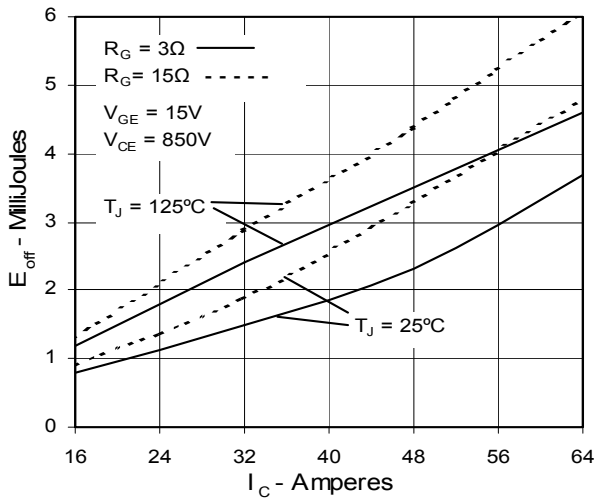

Fig. 10. Dependence of E_{off} on Temperature

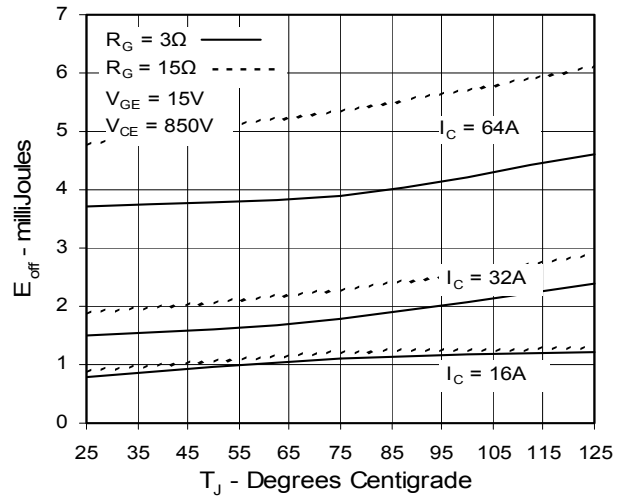

Fig. 11. Gate Charge

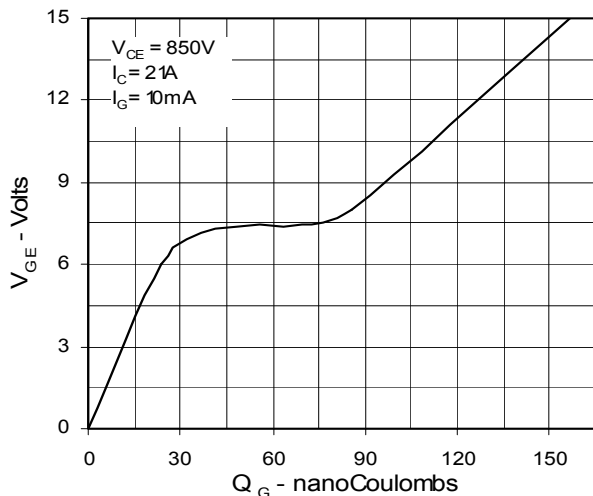
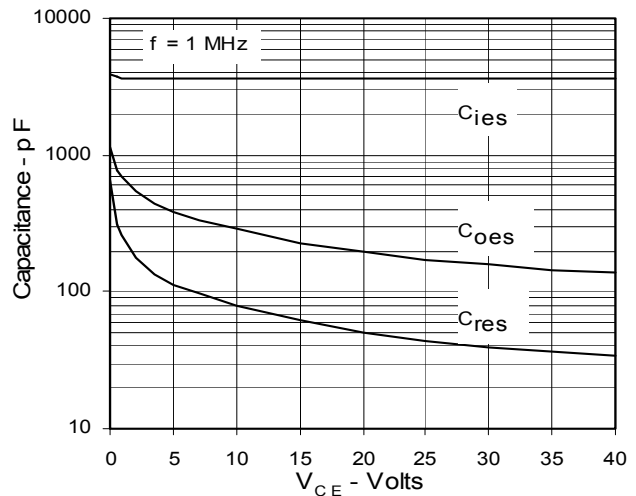

Fig. 12. Capacitance



IXYS reserves the right to change limits, test conditions, and dimensions.

IXYS MOSFETs and IGBTs are covered by one or more of the following U.S. patents:	4,835,592	4,931,844	5,049,961	5,237,481	6,162,665	6,404,065B1	6,683,344	6,727,585
	4,850,072	5,017,508	5,063,307	5,381,025	6,259,123B1	6,534,343	6,710,405B2	6,759,692
	4,881,106	5,034,796	5,187,117	5,486,715	6,306,728 B1	6,583,505	6,710,463	

Fig. 13. Maximum Transient Thermal Resistance

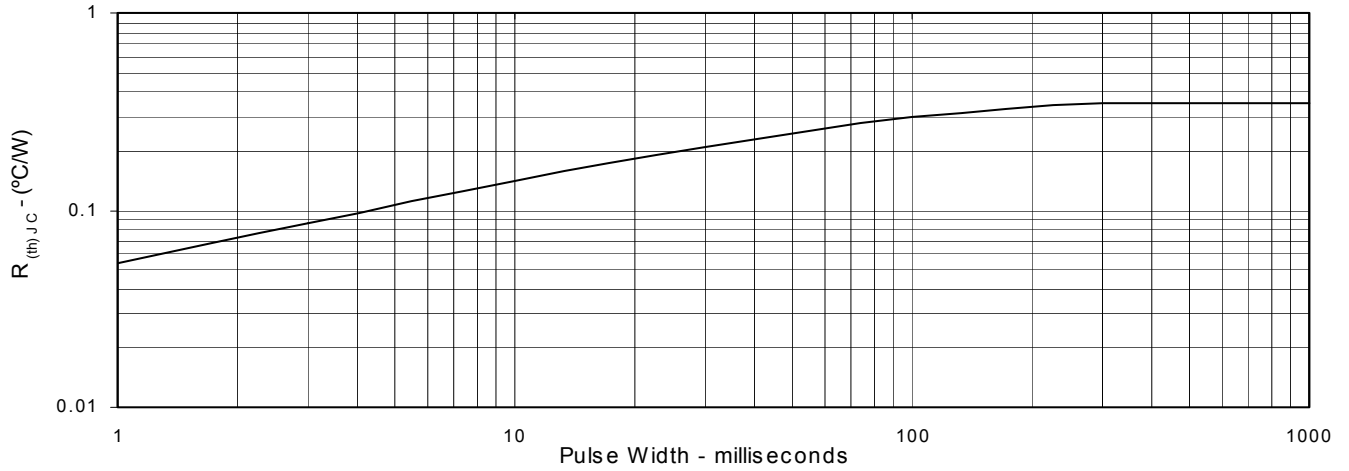

Mouser Electronics

Authorized Distributor

Click to View Pricing, Inventory, Delivery & Lifecycle Information:

[IXYS:](#)

[IXGH32N170A](#) [IXGT32N170A](#)