

THIS DRAWING IS UNPUBLISHED. RELEASED FOR PUBLICATION 20  
 © COPYRIGHT 20 BY - ALL RIGHTS RESERVED.

REVISIONS					
P	LTR	DESCRIPTION	DATE	DWN	APVD
	N	REDRAWN/REVISED PER ECO-17-001757	11NOV2017	GR	JO

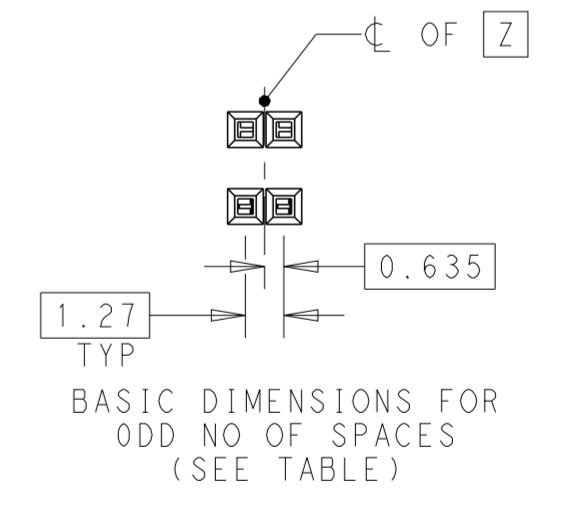
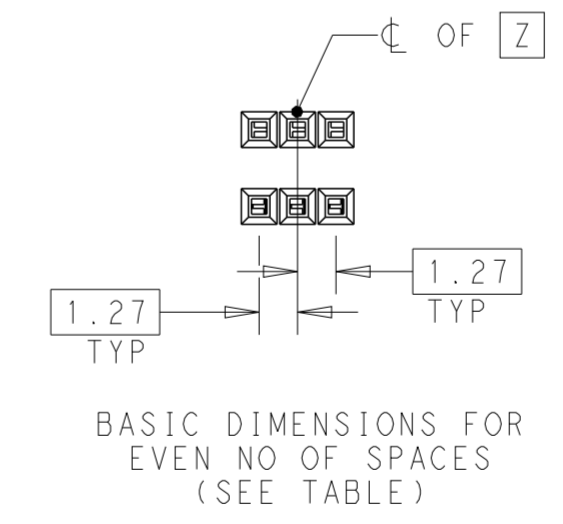
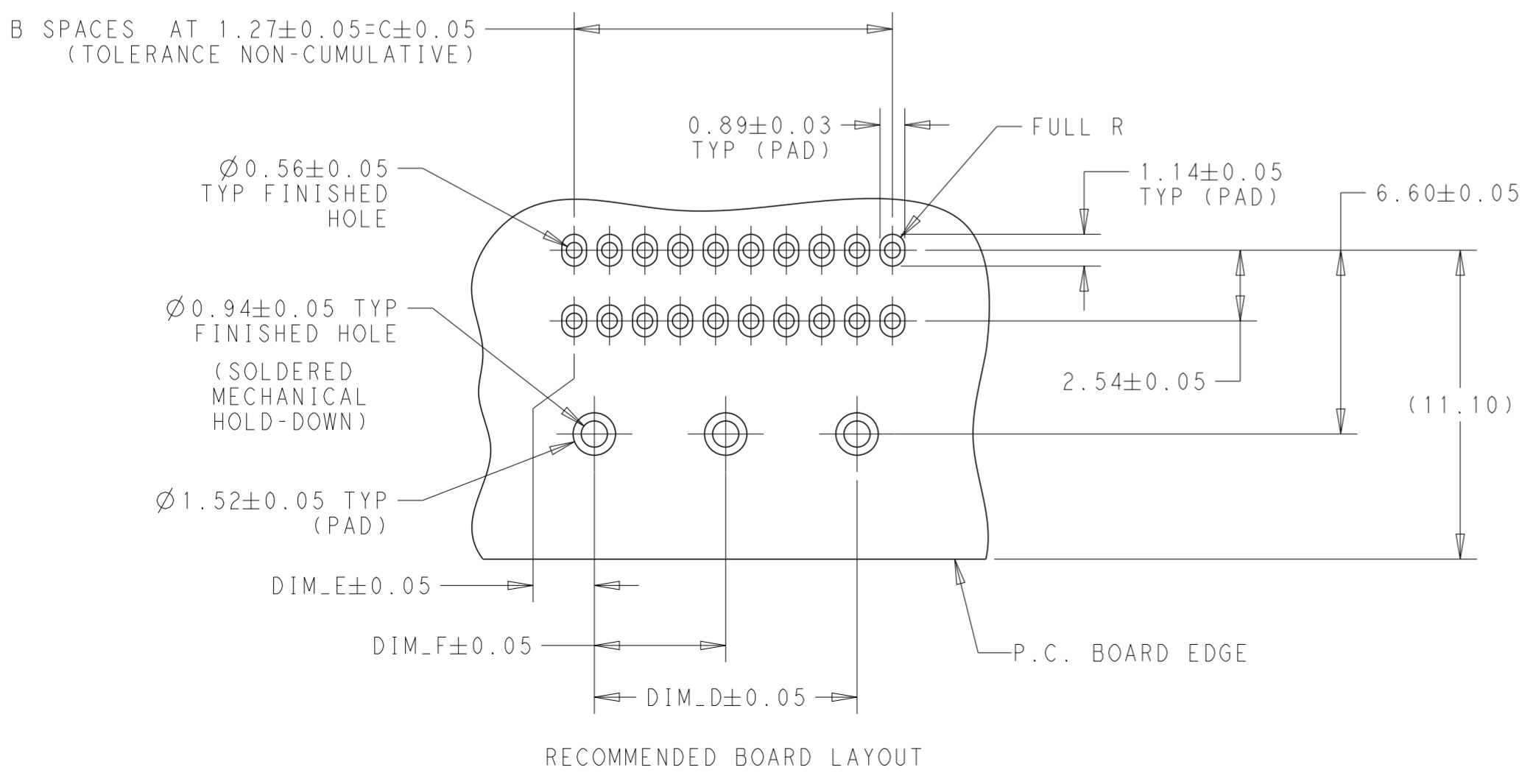
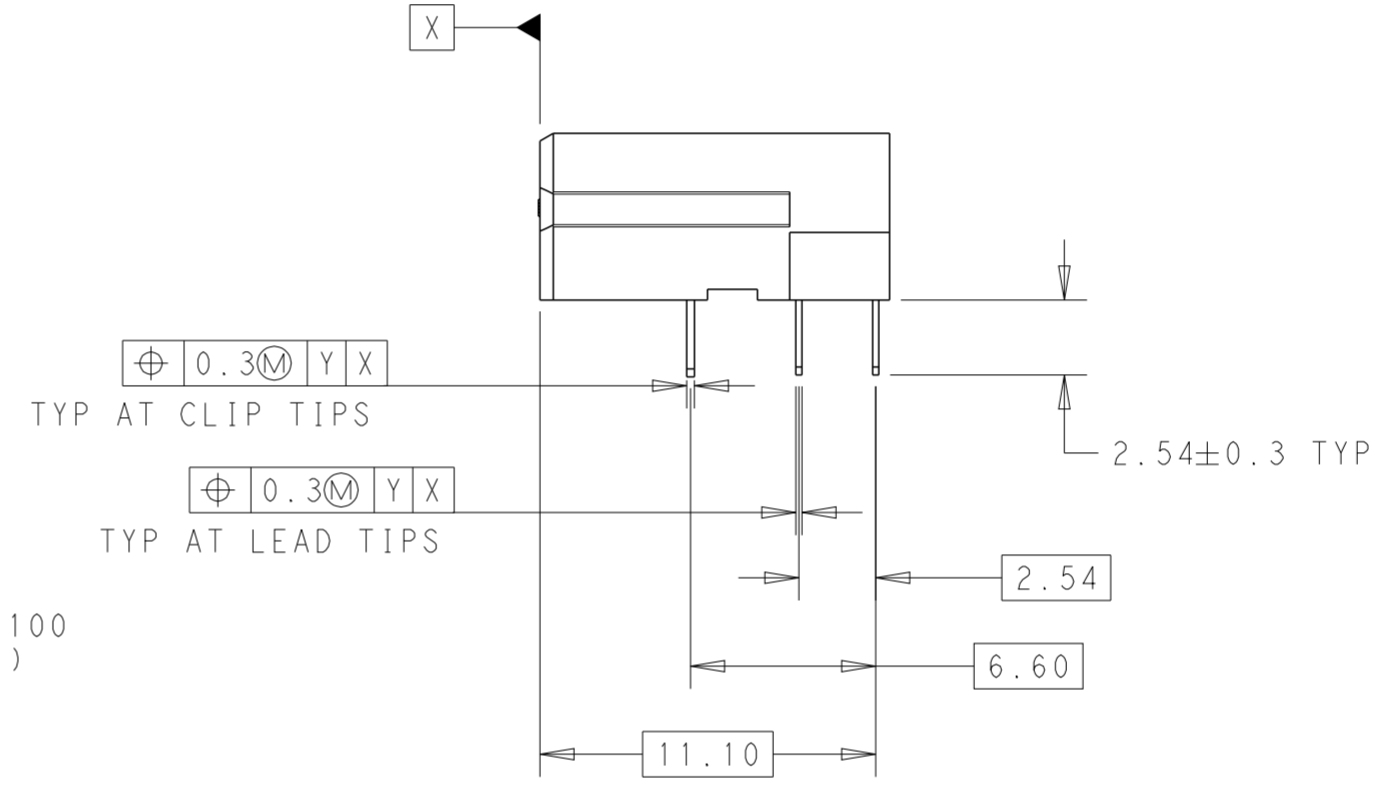
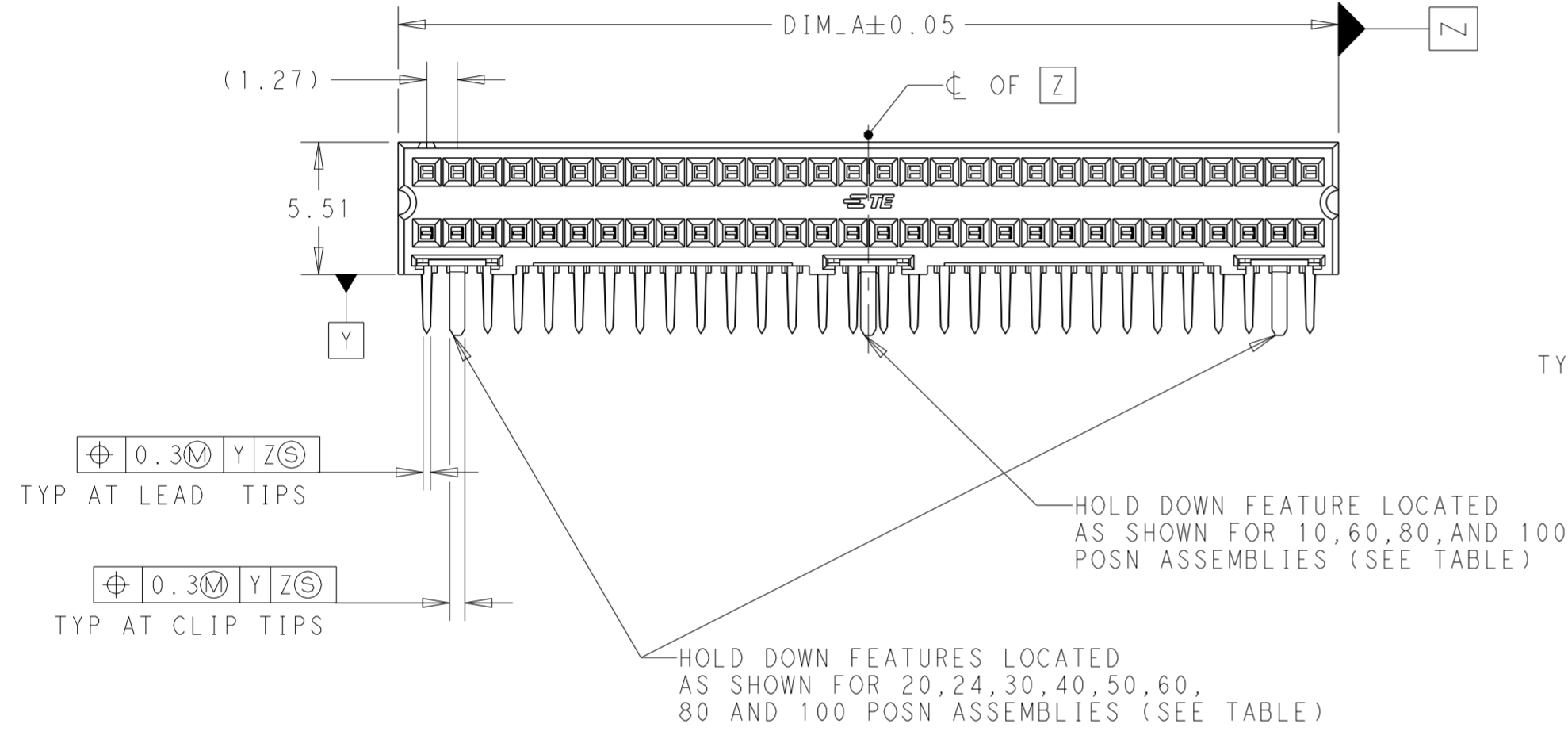
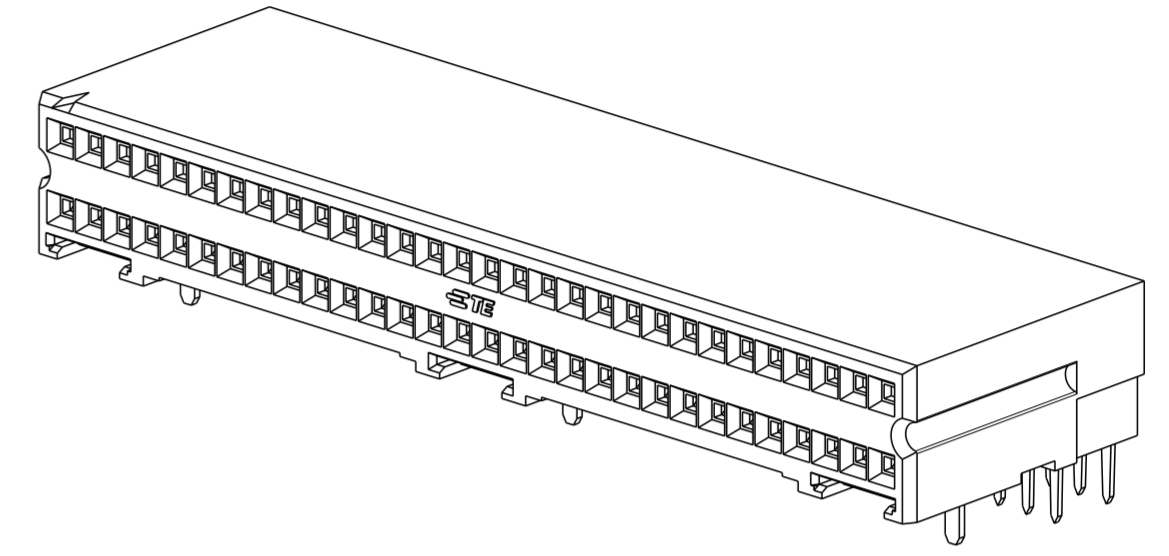
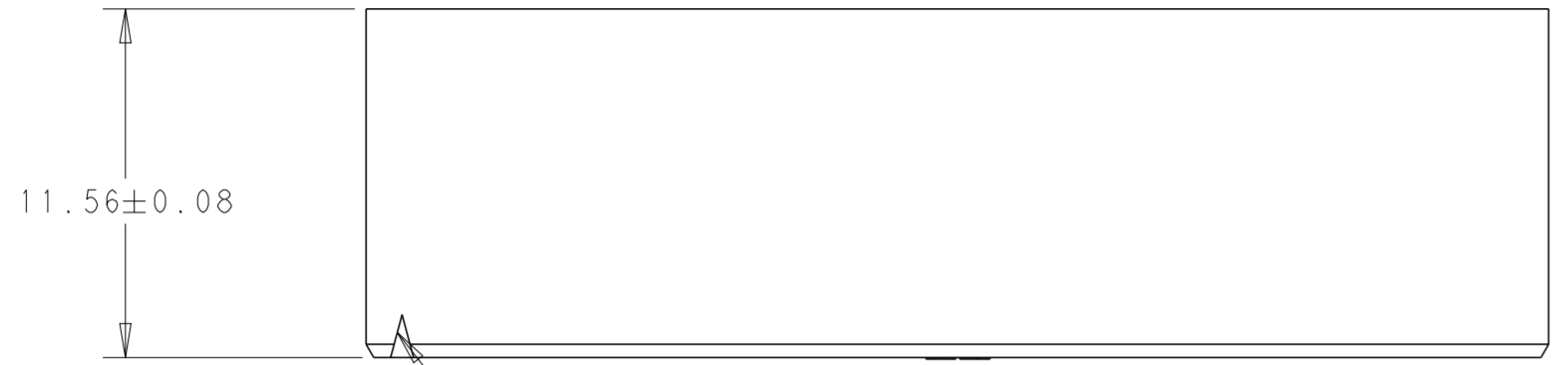

THIS DRAWING IS A CONTROLLED DOCUMENT.		DWN G. RAMESH 11NOV2017	TE Connectivity		
DIMENSIONS: mm		CHK J. OLSON 11NOV2017			
TOLERANCES UNLESS OTHERWISE SPECIFIED:		APVD J. OLSON 11NOV2017	NAME RECEPTACLE ASSEMBLY, RIGHT ANGLE, AMPMODU SYSTEM 50		
0 PLC	±	PRODUCT SPEC	SIZE		
1 PLC	±0.3	108-1093	CAGE CODE		
2 PLC	±0.13	APPLICATION SPEC	DRAWING NO		
3 PLC	±	114-25031	RESTRICTED TO		
4 PLC	±	WEIGHT	A200779		
ANGLES	±0.5°	CUSTOMER DRAWING	SCALE 4:1 SHEET 1 OF 2 REV N		
FINISH	SEE TABLE				

THIS DRAWING IS UNPUBLISHED. RELEASED FOR PUBLICATION 20  
 © COPYRIGHT 20 BY - ALL RIGHTS RESERVED.

REVISIONS				
P	LTR	DESCRIPTION	DATE	APVD
-	-	SEE SHEET 1	-	-

- 1 CONTACT AREA PLATED WITH 0.76µm GOLD;  
SOLDER CLIPS AND LEADS PLATED WITH 3.81µm TIN-LEAD,  
ALL OVER 1.27µm NICKEL
- 2 NOTE DELETED.
- 3 HOUSING: LCP, COLOR-BLACK.  
CONTACT: COPPER ALLOY.  
SOLDER CLIP: PHOSPHOR BRONZE
- 4 CONTACT AREA PLATED WITH 0.76µm GOLD;  
SOLDER CLIPS AND LEADS PLATED WITH 3.81µm TIN ALL OVER 1.27µm
- 5 NOTE DELETED.
- 6 ROHS 2002/95/EC COMPLIANT
- 7 FINISH: 0.03µm MIN.GOLD ON GOLD PLATED AREA, 3.81µm  
MATTE TIN LEAD ON PLATE AREA, UNDER PLATING SHOULD BE 1.27µm  
NICKEL ON ENTIRE CONTACT.
- 8 NOTE DELETED.
- 9 NOTE DELETED.
- 10 NOTE DELETED.
- 11 FINISH: 0.03µm MIN.GOLD ON GOLD PLATED AREA, 3.81µm  
MATTE TIN ON TIN PLATED AREA, UNDER PLATING SHOULD BE 1.27µm  
NICKEL ON ENTIRE CONTACT

11 6	-	1.27	11.43	13.97	11	16.36	24	7-103911-9
	29.85	1.27	59.69	62.23	49	64.62	100	7-103911-8
	-	1.27	15.24	17.78	14	20.17	30	7-103911-7
	23.5	1.27	46.99	49.53	39	51.92	80	7-103911-6
	-	1.27	21.59	24.13	19	26.52	40	7-103911-5
	-	1.27	27.94	30.48	24	32.87	50	7-103911-4
	17.15	1.27	34.29	36.83	29	39.22	60	7-103911-3
	-	1.27	8.89	11.43	9	13.82	20	7-103911-2
-	2.54	-	5.08	4	7.47	10	7-103911-1	
4 6	-	1.27	11.43	13.97	11	16.36	24	5-103911-9
	29.85	1.27	59.69	62.23	49	64.62	100	5-103911-8
	-	1.27	15.24	17.78	14	20.17	30	5-103911-7
	23.5	1.27	46.99	49.53	39	51.92	80	5-103911-6
	-	1.27	21.59	24.13	19	26.52	40	5-103911-5
	-	1.27	27.94	30.48	24	32.87	50	5-103911-4
	17.15	1.27	34.29	36.83	29	39.22	60	5-103911-3
	-	1.27	8.89	11.43	9	13.82	20	5-103911-2
-	2.54	-	5.08	4	7.47	10	5-103911-1	
FINISH	DIM_F	DIM_E	DIM_D	DIM_C	B SPACES	DIM_A	NO OF POSN	PART NUMBER

7	-	1.27	11.43	13.97	11	16.36	24	2-103911-9
	29.85	1.27	59.69	62.23	49	64.62	100	2-103911-8
	-	1.27	15.24	17.78	14	20.17	30	2-103911-7
	23.5	1.27	46.99	49.53	39	51.92	80	2-103911-6
	-	1.27	21.59	24.13	19	26.52	40	2-103911-5
	-	1.27	27.94	30.48	24	32.87	50	2-103911-4
	17.15	1.27	34.29	36.83	29	39.22	60	2-103911-3
	-	1.27	8.89	11.43	9	13.82	20	2-103911-2
-	2.54	-	5.08	4	7.47	10	2-103911-1	
1	-	1.27	11.43	13.97	11	16.36	24	103911-9
	29.85	1.27	59.69	62.23	49	64.62	100	103911-8
	-	1.27	15.24	17.78	14	20.17	30	103911-7
	23.5	1.27	46.99	49.53	39	51.92	80	103911-6
	-	1.27	21.59	24.13	19	26.52	40	103911-5
	-	1.27	27.94	30.48	24	32.87	50	103911-4
	17.15	1.27	34.29	36.83	29	39.22	60	103911-3
	-	1.27	8.89	11.43	9	13.82	20	103911-2
-	2.54	-	5.08	4	7.47	10	103911-1	
FINISH	DIM_F	DIM_E	DIM_D	DIM_C	B SPACES	DIM_A	NO OF POSN	PART NUMBER

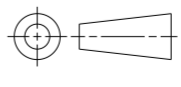
THIS DRAWING IS A CONTROLLED DOCUMENT.		DWN G. RAMESH 11NOV2017	 TE Connectivity	
DIMENSIONS: mm		CHK J. OLSON 11NOV2017		
TOLERANCES UNLESS OTHERWISE SPECIFIED:		APVD J. OLSON 11NOV2017	NAME RECEPTACLE ASSEMBLY, RIGHT ANGLE, AMPMODU SYSTEM 50	
		PRODUCT SPEC 108-1093	SIZE -	
MATERIAL -		APPLICATION SPEC 114-25031	CAGE CODE A200779	DRAWING NO C-103911
SEE TABLE		WEIGHT -	RESTRICTED TO -	SCALE 4:1
		CUSTOMER DRAWING	SHEET 2	REV N

# Mouser Electronics

Authorized Distributor

Click to View Pricing, Inventory, Delivery & Lifecycle Information:

[TE Connectivity:](#)

[5-103911-4](#)